



**DODGE**

**JOURNEY**

**OWNER'S MANUAL**  
**2009**

## VEHICLES SOLD IN CANADA

With respect to any Vehicles Sold in Canada, the name Chrysler LLC shall be deemed to be deleted and the name Chrysler Canada Inc. used in substitution therefor.

### DRIVING AND ALCOHOL

Drunken driving is one of the most frequent causes of accidents.

Your driving ability can be seriously impaired with blood alcohol levels far below the legal minimum. If you are drinking, don't drive. Ride with a designated non-drinking driver, call a cab, a friend, or use public transportation.

### WARNING!

**Driving after drinking can lead to an accident. Your perceptions are less sharp, your reflexes are slower, and your judgment is impaired when you have been drinking. Never drink and then drive.**

This manual illustrates and describes the operation of features and equipment that are either standard or optional on this vehicle. This manual may also include a description of features and equipment that are no longer available or were not ordered on this vehicle. Please disregard any features and equipment described in this manual that are not on this vehicle.

Chrysler LLC reserves the right to make changes in design and specifications, and/or make additions to or improvements to its products without imposing any obligation upon itself to install them on products previously manufactured.



# TABLE OF CONTENTS

## SECTION

## PAGE

<b>1</b>	<b>INTRODUCTION .....</b>	<b>3</b>	<b>1</b>
<b>2</b>	<b>THINGS TO KNOW BEFORE STARTING YOUR VEHICLE .....</b>	<b>9</b>	<b>2</b>
<b>3</b>	<b>UNDERSTANDING THE FEATURES OF YOUR VEHICLE .....</b>	<b>79</b>	<b>3</b>
<b>4</b>	<b>UNDERSTANDING YOUR INSTRUMENT PANEL .....</b>	<b>197</b>	<b>4</b>
<b>5</b>	<b>STARTING AND OPERATING .....</b>	<b>299</b>	<b>5</b>
<b>6</b>	<b>WHAT TO DO IN EMERGENCIES .....</b>	<b>389</b>	<b>6</b>
<b>7</b>	<b>MAINTAINING YOUR VEHICLE .....</b>	<b>413</b>	<b>7</b>
<b>8</b>	<b>MAINTENANCE SCHEDULES .....</b>	<b>473</b>	<b>8</b>
<b>9</b>	<b>IF YOU NEED CONSUMER ASSISTANCE .....</b>	<b>485</b>	<b>9</b>
<b>10</b>	<b>INDEX .....</b>	<b>495</b>	<b>10</b>



# INTRODUCTION

## CONTENTS

---

■ Introduction . . . . .	4	■ Vehicle Identification Number . . . . .	6
■ How To Use This Manual . . . . .	4	■ Vehicle Modifications/Alterations . . . . .	7
■ Warnings And Cautions . . . . .	6		

### INTRODUCTION

This manual has been prepared with the assistance of service and engineering specialists to acquaint you with the operation and maintenance of your new vehicle. It is supplemented by a Warranty Information Booklet and various customer-oriented documents. You are urged to read these publications carefully. Following the instructions and recommendations in this manual will help assure safe and enjoyable operation of your vehicle.

**NOTE:** After you read the manual, it should be stored in the vehicle for convenient reference and remain with the vehicle when sold so that the new owner will be aware of all safety warnings.

































When it comes to service, remember that your authorized dealer knows your vehicle best, has the factory-trained technicians and genuine Mopar® parts, and is interested in your satisfaction.

### HOW TO USE THIS MANUAL

Consult the Table of Contents to determine which section contains the information you desire.

The detailed Index at the back of this manual contains a complete listing of all subjects.

Consult the following table for a description of the symbols that may be used on your vehicle or throughout this Owner's Manual.

											<b>ESP BAS</b> ELECTRONIC STABILITY PROGRAM / BRAKE ASSIST SYSTEM
											<b>BRAKE</b> BRAKE SYSTEM WARNING PARKING BRAKE
										<b>AWD!</b>	 FAILURE OF ANTI-LOCK BRAKING SYSTEM
										<b>4WD!</b>	<b>BRAKE</b> BRAKE SYSTEM WARNING PARKING BRAKE
											<b>TOW/HAUL</b> TOW / HAUL
											<b>4 LOW</b> FOUR WHEEL DRIVE LOW
			<b>SRS AIRBAG</b> SUPPLEMENTAL RESTRAINT SYSTEM								

## WARNINGS AND CAUTIONS

This Owners Manual contains **WARNINGS** against operating procedures that could result in an accident or bodily injury. It also contains **CAUTIONS** against procedures that could result in damage to your vehicle. If you do not read this entire Owners Manual, you may miss important information. Observe all Warnings and Cautions.

## VEHICLE IDENTIFICATION NUMBER

The Vehicle Identification Number (VIN) is on the left front corner of the instrument panel and is visible from outside of the vehicle through the windshield. This number also appears on the Automobile Information Disclosure Label affixed to a window on your vehicle, the vehicle registration, and the title.

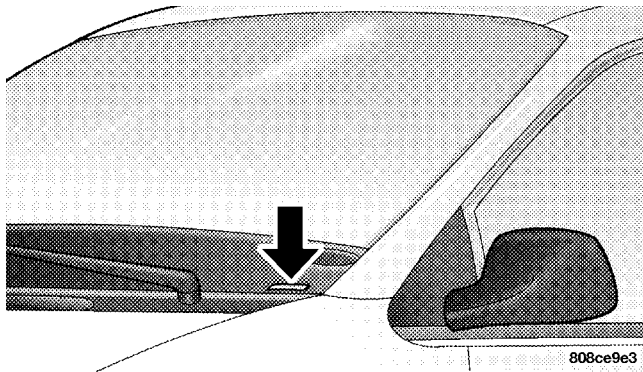

**VIN Location**

**NOTE:** It is illegal to remove the VIN.



**VEHICLE MODIFICATIONS/ALTERATIONS****WARNING!**

**Any modifications or alterations to this vehicle could seriously affect its roadworthiness and safety and may lead to an accident resulting in serious injury or death.**



# THINGS TO KNOW BEFORE STARTING YOUR VEHICLE

## CONTENTS

---

■ A Word About Your Keys . . . . .	12	□ General Information . . . . .	18
□ Wireless Ignition Node (WIN) . . . . .	12	■ Security Alarm System — If Equipped . . . . .	18
□ FOB With Integrated Key . . . . .	13	□ Rearming Of The System . . . . .	18
□ Tip Start Feature . . . . .	14	□ To Arm The System . . . . .	19
□ Ignition Key Removal . . . . .	14	□ To Disarm The System . . . . .	19
□ Key-In-Ignition Reminder . . . . .	15	■ Illuminated Entry System . . . . .	20
■ Sentry Key® Immobilizer System . . . . .	15	■ Remote Keyless Entry (RKE) . . . . .	20
□ Replacement Keys . . . . .	16	□ To Unlock The Doors And Liftgate . . . . .	21
□ Customer Key Programming . . . . .	17	□ To Lock The Doors And Liftgate . . . . .	23

## 10 THINGS TO KNOW BEFORE STARTING YOUR VEHICLE

- Using The Panic Alarm . . . . .24
- Programming Additional Transmitters . . . . .25
- Transmitter Battery Service . . . . .25
- General Information . . . . .26
- Remote Starting System — If Equipped . . . . .26
  - How To Use Remote Start . . . . .26
- Door Locks . . . . .28
  - Manual Door Locks . . . . .28
  - Power Door Locks . . . . .29
  - Child Protection Door Lock System  
(Rear Doors) . . . . .31
- Windows . . . . .34
  - Power Windows . . . . .34
  - Wind Buffeting . . . . .37
- Liftgate . . . . .37
- Occupant Restraints . . . . .38
  - Lap/Shoulder Belts . . . . .40
  - Lap/Shoulder Belt Untwisting Procedure . . . . .45
  - Seat Belt Pretensioners . . . . .46
  - Enhanced Seat Belt Reminder System  
(BeltAlert®) . . . . .46
  - Automatic Locking Mode . . . . .47
  - Seat Belts And Pregnant Women . . . . .48
  - Seat Belt Extender . . . . .48
  - Driver And Front Passenger Supplemental  
Restraint System (SRS) - Airbag . . . . .49



- Event Data Recorder (EDR) . . . . .62
- Child Restraint . . . . .64
- Engine Break-In Recommendations . . . . .74
- Safety Tips . . . . .74
  - Transporting Passengers . . . . .74
  - Lock Your Vehicle . . . . .75

**THINGS TO KNOW BEFORE STARTING YOUR VEHICLE 11**

- Exhaust Gas . . . . .75
- Safety Checks You Should Make Inside The Vehicle . . . . .76
- Periodic Safety Checks You Should Make Outside The Vehicle . . . . .77

## A WORD ABOUT YOUR KEYS

Your vehicle uses a keyless ignition system. This system consists of a Fob with Integrated Key and a Wireless Ignition Node (WIN) with integral ignition switch. You can insert the double-sided integrated key into the ignition switch with either side up.

### Wireless Ignition Node (WIN)

The Wireless Ignition Node (WIN) operates similarly to an ignition switch. It has four operating positions, three of which are detented and one spring-loaded. The detented positions are LOCK, ACC, and ON. The START position is a spring-loaded momentary contact position. When released from the START position, the switch automatically returns to the detented ON position.

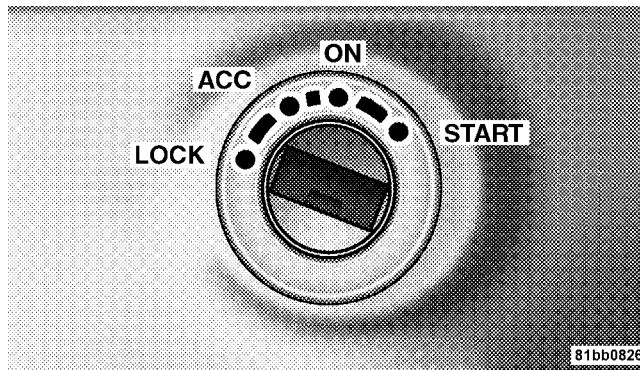

Wireless Ignition Node (WIN)

### Fob With Integrated Key

The Fob with Integrated Key operates the ignition switch. It also contains the Remote Keyless Entry (RKE) transmitter and a valet key, which stores in the rear of the Fob.

The valet key allows for entry into the vehicle should the battery in the vehicle or the Fob go dead. You can keep the valet key with you when valet parking.

To remove the valet key from the Fob, slide the mechanical latch at the top of the Fob sideways with your thumb and then pull the key out of the Fob with your other hand.

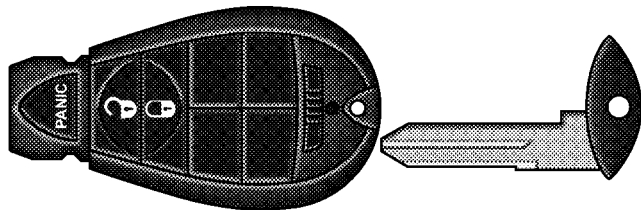

2

81bb182d

### Valet Key Removal

#### NOTE:

- You can insert the double-sided valet key into the lock cylinder with either side up.
- Only the drivers door is equipped with a lock cylinder.

**Tip Start Feature**

**Do not** press the accelerator. Use the Fob with Integrated Key to briefly turn the ignition switch to the START position and release it as soon as the starter engages. The starter motor will continue to run, and it will disengage automatically when the engine is running.

**Ignition Key Removal**

Place the shift lever in PARK. Turn the key to the LOCK position and then remove the key.

**NOTE:**

- For vehicles not equipped with the Electronic Vehicle Information Center (EVIC), the power window switches, radio, power sunroof (if equipped), and ignition-powered power outlets will remain active for approximately 45 seconds after the ignition switch is turned to the LOCK position. Opening either front door will cancel this feature.

- For vehicles equipped with the EVIC, the power window switches, radio, power sunroof (if equipped), and ignition-powered power outlets will remain active for up to 10 minutes after the ignition switch is turned to the LOCK position. Opening either front door will cancel this feature. The time for this feature is programmable. Refer to “Key-Off Power Delay,” under “Personal Settings (Customer Programmable Features)” under “Electronic Vehicle Information Center (EVIC)” in Section 4.

**WARNING!**

**Never leave children alone in a vehicle. Leaving unattended children in a vehicle is dangerous for a number of reasons. A child or others could be seriously or fatally injured. Don't leave the key in the ignition. A child could operate power windows, other controls, or move the vehicle.**



**CAUTION!**

**An unlocked car is an invitation to thieves. Always remove the key from the ignition and lock all doors when leaving the vehicle unattended.**

**Key-In-Ignition Reminder**

If you open the driver's door and the key is in the ignition, a chime will sound to remind you to remove the key.

**NOTE:** The Key-In-Ignition reminder only sounds when the ignition key is placed in the LOCK or ACC position.

**SENTRY KEY® IMMOBILIZER SYSTEM**

The Sentry Key® Immobilizer system prevents unauthorized vehicle operation by disabling the engine. The system does not need to be armed or activated. Operation is automatic, regardless of whether the vehicle is locked or unlocked.

The system uses the factory-mated Remote Keyless Entry (RKE) transmitter with integrated key and Wireless Ignition Node (WIN) to prevent unauthorized vehicle operation. Therefore, only RKE transmitters that are programmed to the vehicle can be used to start and operate the vehicle. The system will not allow the engine to crank if an invalid RKE transmitter is used to operate the ignition switch.

After turning the ignition switch to the ON position, the Vehicle Security Alarm Indicator Light will turn on for three seconds for a bulb check. If the light remains on

after the bulb check, it indicates that there is a problem with the electronics. This condition will result in the engine being shut off after two seconds.

If the Vehicle Security Alarm Indicator Light turns on during normal vehicle operation (vehicle running for longer than 10 seconds), it indicates that there is a fault in the electronics. Should this occur, have the vehicle serviced as soon as possible.

**NOTE:**

- The Sentry Key® Immobilizer system is not compatible with aftermarket remote starting systems. Use of these systems may result in vehicle starting problems and loss of security protection.
- Exxon/Mobil Speedpass™, additional RKE transmitters, or any other transponder-equipped components on the same key chain **will not** cause a fault unless the

additional part is **physically held against the transmitter** being used to start the vehicle. Cell phones, pagers, or other RF electronics will not cause interference with this system.

All of the RKE transmitters provided with your new vehicle have been programmed to the vehicle electronics.

**Replacement Keys**

**NOTE:** Only RKE transmitters that are programmed to the vehicle electronics can be used to start and operate the vehicle. Once a transmitter is programmed to a vehicle, it cannot be programmed to any other vehicle.

**CAUTION!**

**Always remove the keys from the vehicle and lock all doors when leaving the vehicle unattended.**

At the time of purchase, the original owner is provided with a four-digit Personal Identification Number (PIN). Keep the PIN in a secure location. This number is required for authorized dealer replacement of RKE transmitters. Duplication of RKE transmitters may be performed at an authorized dealer or by using the Customer Key Programming procedure. This procedure consists of programming a blank transmitter to the vehicle electronics. A blank transmitter is one that has never been programmed.

**NOTE:** When having the Sentry Key® Immobilizer system serviced, bring all vehicle RKE transmitters with you to the authorized dealer.

### **Customer Key Programming**

If you have two valid RKE transmitters with integrated keys, you can program new transmitters to the system by performing the following steps:

1. Insert the first valid integrated key into the ignition switch and turn the ignition switch to the ON position for at least three seconds, but no longer than 15 seconds. Turn the ignition switch to the LOCK position and remove the first key.
2. Insert the second valid integrated key and turn the ignition switch to the ON position within 15 seconds. After 10 seconds, a chime will sound and the Vehicle Security Alarm Indicator Light will begin to flash. Turn the ignition switch to the LOCK position and remove the second key.
3. Insert a blank integrated key into the ignition switch and turn the ignition switch to the ON position within 60 seconds. After 10 seconds, a single chime will sound and the Vehicle Security Alarm Indicator Light will stop flashing, turn on again for three seconds, and then turn off.

The new integrated key is programmed. **The RKE transmitter will also be programmed during this procedure.**

Repeat this procedure to program up to eight keys. If you do not have a programmed RKE transmitter with integrated key, contact your authorized dealer for details.

**NOTE:** If a programmed key is lost, see your authorized dealer to have all remaining keys erased from the system's memory. This will prevent the lost key from starting your vehicle. The remaining keys must then be reprogrammed. All vehicle keys must be taken to an authorized dealer at the time of service to be reprogrammed.

### General Information

The Sentry Key® system complies with FCC rules Part 15 and with RSS-210 of Industry Canada. Operation is subject to the following conditions:

- This device may not cause harmful interference.

- This device must accept any interference that may be received, including interference that may cause undesired operation.

### SECURITY ALARM SYSTEM — IF EQUIPPED

The Vehicle Security Alarm (VSA) system monitors the vehicle doors and liftgate for unauthorized entry and the ignition switch for unauthorized operation. If something triggers the alarm, the system will prevent the vehicle from starting, sound the horn intermittently, flash the headlights and taillights, and flash the Vehicle Security Alarm Indicator Light in the instrument cluster.

### Rearming of the System

If something triggers the alarm, and no action is taken to disarm it, the system will turn off the horn after three minutes, turn off all of the visual signals after 15 minutes, and then the system will rearm itself.

## To Arm the System

1. Remove the key from the ignition switch and exit the vehicle.
2. Lock the doors and liftgate by pressing the power door lock switch or the lock button on the Remote Keyless Entry (RKE) transmitter.

**NOTE:** The system will not arm if you lock the doors with the manual door lock plungers or the door lock cylinder on the driver's door.

3. Close all doors. The Vehicle Security Alarm Indicator Light in the instrument cluster will flash rapidly for about 16 seconds to signal that the system is arming. During this period, opening any door or the liftgate will cancel the arming process. If the system arms successfully, the Vehicle Security Alarm Indicator Light will flash at a slower rate to indicate the alarm is set.

**NOTE:** For added security, whenever the Security Alarm is armed, the HomeLink®/Garage Door Opener (if equipped) is disabled as well.

## To Disarm the System

Either press the UNLOCK button on the RKE transmitter or insert a valid ignition key into the ignition lock cylinder and turn the key to the ON position.

### **NOTE:**

- Unlocking the doors with the manual door lock plungers or the door lock cylinder on the driver's door will not disarm the system.
- When the system is armed, the interior power door lock switches will not unlock the doors.

The Security Alarm System is designed to protect your vehicle; however, you can create conditions where the system will give you a false alarm. If the previously described arming sequence has occurred, the system will

arm regardless of whether you are inside or outside the vehicle. If you remain inside the vehicle and open a door, the alarm will sound. If this occurs, disarm the system.

### **Tamper Alert**

If something has triggered the alarm in your absence, the horn will sound three times when you unlock the doors. Check the vehicle for tampering.

### **ILLUMINATED ENTRY SYSTEM**

The interior lights will turn on when you press the UNLOCK button on the Remote Keyless Entry (RKE) transmitter or open a door or the liftgate.

This feature also turns on the approach lighting (if so equipped). Refer to “Illumin Approach,” under “Personal Settings (Customer Programmable Features),” under “Electronic Vehicle Information Center (EVIC)” in Section 4.

The interior lights will fade to off after about 30 seconds or they will immediately fade to off once the ignition switch is turned ON.

### **NOTE:**

- The illuminated entry system will not operate the interior lights if the Dimmer Control is in the extreme downward (Defeat) position.

### **REMOTE KEYLESS ENTRY (RKE)**

This system allows you to lock or unlock the doors and liftgate or activate the Panic Alarm from distances up to about 35 ft (11 m) using a hand-held radio transmitter. The transmitter need not be pointed at the vehicle to activate the system.

**NOTE:** Inserting the Fob with Integrated Key into the ignition switch disables all buttons on that transmitter; however, the buttons on the remaining transmitters will continue to work. Driving at speeds 5 mph (8 km/h) and above disables all transmitter buttons for all fobs.

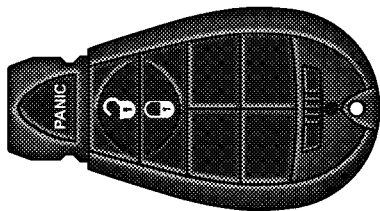

81c6853a

**Remote Keyless Entry (RKE) Transmitter**

### **To Unlock the Doors and Liftgate**

Press and release the UNLOCK button on the transmitter once to unlock the driver's door, or twice within five seconds to unlock all doors and liftgate. The turn signal lights will flash to acknowledge the unlock signal. The illuminated entry system will also turn on.

### **Remote Key Unlock, Driver Door/All Doors First**

This feature lets you program the system to unlock either the driver's door or all doors on the first press of the UNLOCK button on the transmitter. To change the current setting, proceed as follows:

- For vehicles equipped with the Electronic Vehicle Information Center (EVIC), refer to "RKE Unlock," under "Personal Settings (Customer Programmable Features)," under "Electronic Vehicle Information Center (EVIC)" in Section 4.

- For vehicles not equipped with the EVIC, perform the following steps:

1. Press and hold the LOCK button on a programmed transmitter for at least four seconds, but no longer than 10 seconds. Then, press and hold the UNLOCK button while still holding the LOCK button.
2. Release both buttons at the same time.
3. Test the feature while outside of the vehicle by pressing the LOCK/UNLOCK buttons on the transmitter with the ignition switch in the LOCK position and the key removed.
4. Repeat these steps if you want to return this feature to its previous setting.

**NOTE:** Pressing the LOCK button on the transmitter while you are inside the vehicle will activate the Security Alarm. Opening a door with the Security Alarm activated will cause the alarm to sound. Press the UNLOCK button to deactivate the Security Alarm.

### **Flash Lights with Remote Key Lock**

This feature will cause the turn signal lights to flash when the doors are locked or unlocked with the transmitter. This feature can be turned on or turned off. To change the current setting, proceed as follows:

- For vehicles equipped with the EVIC, refer to “Flash Light With Lock,” under “Personal Settings (Customer Programmable Features),” under “Electronic Vehicle Information Center (EVIC)” in Section 4.
- For vehicles not equipped with the EVIC, perform the following steps:
  1. Press and hold the UNLOCK button on a programmed transmitter for at least four seconds, but no longer than 10 seconds. Then, press and hold the LOCK button while still holding the UNLOCK button.
  2. Release both buttons at the same time.



3. Test the feature while outside of the vehicle by pressing the LOCK/UNLOCK buttons on the transmitter with the ignition switch in the LOCK position and the key removed.

4. Repeat these steps if you want to return this feature to its previous setting.

**NOTE:** Pressing the LOCK button on the transmitter while you are in the vehicle will activate the Security Alarm. Opening a door with the Security Alarm activated will cause the alarm to sound. Press the UNLOCK button to deactivate the Security Alarm.

### **Illuminated Approach — If Equipped**

This feature activates the headlights for up to 90 seconds when the doors are unlocked with the transmitter. The time for this feature is programmable on vehicles equipped with the EVIC. Refer to “Illumin Approach,”

under “Personal Settings (Customer Programmable Features),” under “Electronic Vehicle Information Center (EVIC)” in Section 4.

### **To Lock the Doors and Liftgate**

Press and release the LOCK button on the transmitter to lock all doors and liftgate. The turn signal lights will flash and the horn will chirp to acknowledge the signal.

### **Sound Horn with Remote Key Lock**

This feature will cause the horn to chirp when the doors are locked with the transmitter. This feature can be turned on or turned off. To change the current setting, proceed as follows:

- For vehicles equipped with the EVIC, refer to “Sound Horn with Lock,” under “Personal Settings (Customer Programmable Features),” under “Electronic Vehicle Information Center (EVIC)” in Section 4.

- For vehicles not equipped with the EVIC, perform the following steps:

1. Press the LOCK button on a programmed transmitter for at least four seconds, but no longer than 10 seconds. Then, press the PANIC button while still holding the LOCK button.

2. Release both buttons at the same time.

3. Test the feature while outside of the vehicle by pressing the LOCK button on the transmitter with the ignition switch in the LOCK position and the key removed.

4. Repeat these steps if you want to return this feature to its previous setting.

**NOTE:** Pressing the LOCK button on the transmitter while you are in the vehicle will activate the Security Alarm. Opening a door with the Security Alarm activated will cause the alarm to sound. Press the UNLOCK button to deactivate the Security Alarm.

### Using the Panic Alarm

To turn the Panic Alarm feature ON or OFF, press and hold the PANIC button on the transmitter for at least one second and release. When the Panic Alarm is on, the headlights and park lights will flash, the horn will pulse on and off, and the interior lights will turn on.

The Panic Alarm will stay on for three minutes unless you turn it off by either pressing the PANIC button a second time or drive the vehicle at a speed of 15 mph (24 km/h) or greater.

#### NOTE:

- The interior lights will turn off if you turn the ignition switch to the ACC or ON position while the Panic Alarm is activated. However, the exterior lights and horn will remain on.
- You may need to be less than 35 ft (11 m) from the vehicle when using the transmitter to turn off the Panic Alarm due to the radio frequency noises emitted by the system.

## Programming Additional Transmitters

Refer to Sentry Key<sup>®</sup>, “Customer Key Programming.”  
(See page 17 for more information.)

If you do not have a programmed transmitter, contact your authorized dealer for details.

## Transmitter Battery Service

The recommended replacement battery is one CR2032 battery.

### NOTE:

- Perchlorate Material — special handling may apply. See [www.dtsc.ca.gov/hazardouswaste/perchlorate](http://www.dtsc.ca.gov/hazardouswaste/perchlorate)
  - Do not touch the battery terminals that are on the back housing or the printed circuit board.
1. Battery access is through a door located on the rear of the fob. Insert a small, flat blade screwdriver into the slot and gently pry open the access door.

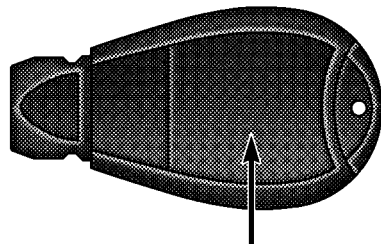

**BATTERY ACCESS DOOR**

81bb1827

### Battery Replacement

2. Remove and replace the batteries. Avoid touching the new batteries with your fingers. Skin oils may cause battery deterioration. If you touch a battery, clean it with rubbing alcohol.
3. Reposition the access door panel over the battery opening and snap into place.

### General Information

This device complies with Part 15 of the FCC rules and RSS 210 of Industry Canada. Operation is subject to the following conditions:

- This device may not cause harmful interference.
- This device must accept any interference received, including interference that may cause undesired operation.

**NOTE:** Changes or modifications not expressly approved by the party responsible for compliance could void the user's authority to operate the equipment.

If your RKE transmitter fails to operate from a normal distance, check for these two conditions.

1. A weak battery in the transmitter. The expected life of the battery is a minimum of three years.
2. Closeness to a radio transmitter such as a radio station tower, airport transmitter, and some mobile or CB radios.

### REMOTE STARTING SYSTEM — IF EQUIPPED

This system uses the Remote Keyless Entry (RKE) transmitter to start the engine conveniently from outside the vehicle while still maintaining security. The system has a targeted range of 328 ft (100 m).

**NOTE:** The vehicle must be equipped with an automatic transaxle to be equipped with Remote Start.

#### How To Use Remote Start

All of the following conditions must be met before the engine will remote start:

- Shift lever in PARK
- Doors closed
- Hood closed
- Liftgate closed
- HAZARD switch off

- BRAKE switch inactive (brake pedal not pressed)
- Ignition key removed from ignition switch
- Battery at an acceptable charge level, and
- RKE PANIC button not pressed.

### To Enter Remote Start Mode

 Press and release the REMOTE START button on the RKE transmitter twice within five seconds. The parking lights will flash and the horn will honk twice (if programmed). Then, the engine will start and the vehicle will remain in the Remote Start mode for a 15-minute cycle.

#### NOTE:

- The park lamps will turn on and remain on during Remote Start mode.
- For security, power window and power sunroof operation (if so equipped) are disabled when the vehicle is in the Remote Start mode.

- The engine can be started two consecutive times (two 15-minute cycles) with the RKE transmitter. However, the ignition switch must be cycled to the ON position before you can repeat the start sequence for a third cycle.

### To Exit Remote Start Mode without Driving the Vehicle

Allow the engine to run for the entire 15-minute cycle.

### To Exit Remote Start Mode and Drive the Vehicle

Before the end of the 15-minute cycle, press and release the UNLOCK button on the RKE transmitter to unlock the doors and disarm the Vehicle Security Alarm (if equipped). Then, insert the key into the ignition switch and turn the switch to the ON position.

**NOTE:** The ignition switch must be in the ON position in order to drive the vehicle.

### To Turn Off the Engine While in Remote Start Mode

Press and release the REMOTE START button one time.

**NOTE:** To avoid inadvertent shut downs, the system will disable the one time press of the REMOTE START button for two seconds after receiving a valid Remote Start request.

### DOOR LOCKS

#### Manual Door Locks

To lock each door, push the door lock plunger on each door trim panel downward. To unlock each door, pull the door lock plunger on each door trim panel upward.

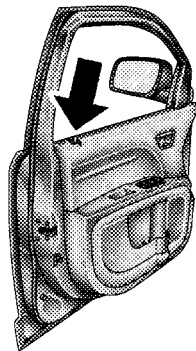

81d10bf0

#### Door Lock Plunger

If the door lock plunger is down when you shut the door, the door will lock. Therefore, make sure the key is not inside the vehicle before closing the door.

**NOTE:** The manual door locks will not lock or unlock the liftgate.

**WARNING!**

- For personal security and safety in the event of an accident, lock the vehicle doors before you drive as well as when you park and leave the vehicle.
- When leaving the vehicle, always remove the key from the ignition and lock your vehicle. Unsupervised use of vehicle equipment may cause severe personal injuries and death.
- Never leave children alone in a vehicle. Leaving unattended children in a vehicle is dangerous for a number of reasons. A child or others could be seriously or fatally injured. Do not leave the key in the ignition. A child could operate power windows, other controls, or move the vehicle.

**Power Door Locks**

A power door lock switch is on each front door trim panel. Use this switch to lock or unlock the doors and liftgate.

2



81d10bf4

**Power Door Lock Switch**

To prevent you from locking your key in the vehicle, the power door lock switch will not operate when the key is in the ignition and either front door is open. A chime will sound as a reminder to remove the key.

### **Automatic Door Locks**

The doors will lock automatically if all of the following conditions are met:

1. The Automatic Door Locks feature is enabled
2. The transaxle is in gear
3. All doors are closed
4. The throttle is pressed
5. The vehicle speed is above 15 mph (24 km/h), and
6. The doors were not previously locked using the power door lock switch or Remote Keyless Entry (RKE) transmitter

### **Automatic Door Locks — If Equipped**

The auto door lock feature can be enabled or disabled by your authorized dealer. See your authorized dealer for programming.

### **Automatic Unlock Doors on Exit**

The doors will unlock automatically if:

1. The Automatic Unlock Doors On Exit feature is enabled
2. The transaxle was in gear and the vehicle speed returned to 0 mph (0 km/h)
3. The transaxle is in NEUTRAL or PARK
4. The driver's door is opened
5. The doors were not previously unlocked, and
6. The vehicle speed is 0 mph (0 km/h).



### Automatic Unlock Doors on Exit Programming

The Automatic Unlock Doors On Exit feature can be enabled or disabled as follows:

- For vehicles equipped with the EVIC, refer to “Personal Settings (Customer Programmable Features)” under “Electronic Vehicle Information Center (EVIC)” in Section 4.
- For vehicles not equipped with the EVIC, perform the following steps:
  1. Enter the vehicle and close all doors.
  2. Place the key in the ignition switch.
  3. Within 15 seconds, cycle the ignition switch between LOCK and ON and then back to LOCK four times ending up in the LOCK position. **However, do not start the engine.**

4. Within 30 seconds, depress the power door unlock switch to unlock the doors.

5. A single chime will indicate the completion of the programming.

**NOTE:** If you do not hear the chime, it means that the system did not enter the programming mode and you will need to repeat the procedure.

6. Repeat these steps if you want to return this feature to its previous setting.

**NOTE:** Use the Automatic Unlock Doors On Exit feature in accordance with local laws.

### Child Protection Door Lock System (Rear Doors)

To provide a safer environment for small children riding in the rear seats, the rear doors are equipped with a Child Protection Door Lock system.

### To Engage the Child Protection Door Lock System

1. Open the rear door.
2. Insert the tip of the valet key (or alike) into the child lock control and rotate it to the LOCK position.

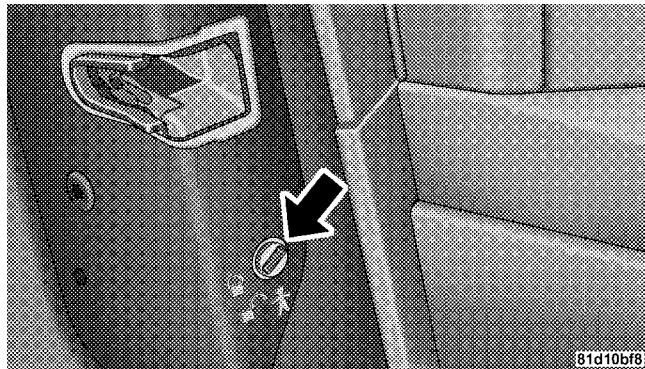

**Child Lock Control**

3. Repeat Steps 1 and 2 for the opposite rear door.

**NOTE:** When the Child Protection Door Lock system is engaged, the door can be opened only by using the outside door handle even though the inside door lock is in the unlocked position.

#### **WARNING!**

**Avoid trapping anyone in a vehicle in a collision. Remember that the rear doors can only be opened from the outside when the child protection locks are engaged. Failure to follow this warning may result in serious injury or death.**

**NOTE:**

- After engaging the Child Protection Door Lock system, always test the door from the inside to make certain it is in the desired position.
- For emergency exit with the system engaged, move the lock plunger up to the UNLOCKED position, roll down the window, and open the door with the outside door handle.

**To Disengage the Child Protection Door Lock System**

1. Open the rear door.
2. Insert the tip of the valet key (or alike) into the child lock control and rotate it to the UNLOCK position.

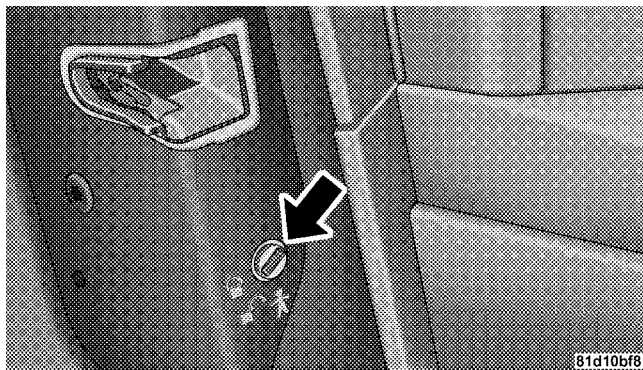
**Child Lock Control**

3. Repeat Steps 1 and 2 for the opposite rear door.

**NOTE:** After disengaging the Child Protection Door Lock system, always test the door from the inside to make certain it is in the desired position.

## WINDOWS

### Power windows

The window controls on the driver's door trim panel control all of the door windows.

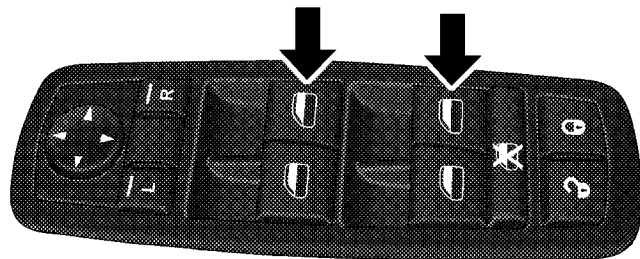

81d10c00

Power Window Switches

There are single window controls on each passenger door trim panel, which operate the passenger door windows. The window controls will operate when the ignition switch is in the ON or ACC position.

### NOTE:

- For vehicles not equipped with the Electronic Vehicle Information Center (EVIC), the power window switches will remain active for 45 seconds after the ignition switch is turned to the LOCK position. Opening either front door will cancel this feature.
- For vehicles equipped with the EVIC, the power window switches will remain active for up to 10 minutes after the ignition switch is turned to the LOCK position. Opening either front door will cancel this feature. The time for this feature is programmable. Refer to “Key-Off Power Delay,” under “Personal

Settings (Customer Programmable Features)” under “Electronic Vehicle Information Center (EVIC)” in Section 4.

### **WARNING!**

**Never leave children in a vehicle with the key in the ignition switch. Occupants, particularly unattended children, can become entrapped by the windows while operating the power window switches. Such entrapment may result in serious injury or death.**

#### **Auto-Down Feature**

The driver’s power window switch has an Auto-down feature. Press the window switch past the first detent, release, and the window will go down automatically.

To open the window part way, press the window switch to the first detent and release it when you want the window to stop.

To stop the window from going all the way down during the Auto-down operation, pull up on the switch briefly.

#### **Auto-Up Feature with Anti-Pinch Protection — If Equipped**

On some models, the driver’s power window switch has an Auto-up feature. Pull the window switch up to the second detent, release, and the window will go up automatically.

To stop the window from going all the way up during the Auto-up operation, push down on the switch briefly.

To close the window part way, pull the window switch up to the first detent and release it when you want the window to stop.

**NOTE:**

- If the window runs into any obstacle during Auto-closure, it will reverse direction and then stop. Remove the obstacle and use the window switch again to close the window.
- Any impact due to rough road conditions may trigger the auto-reverse function unexpectedly during auto-closure. If this happens, pull the switch lightly to the first detent and hold to close window manually.

**WARNING!**

There is no anti-pinch protection when the window is almost closed. To avoid personal injury, be sure to clear your arms, hands, fingers, and objects from the window path before closing the window. Such entrapment may result in serious injury.

**Window Lockout Switch**

The window lockout switch on the driver's door trim panel allows you to disable the window control on the other doors. To disable the window controls, press and release the window lockout button (setting it in the down position). To enable the window controls, press and release the window lockout button again (setting it in the up position).

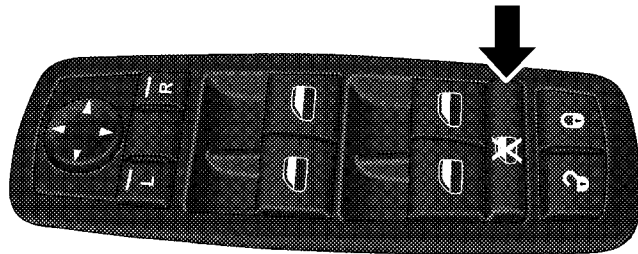

81d10c04

**Window Lockout Switch**

**Reset**

It may be necessary at some point in time to reactivate the Auto-up/Auto-down feature. To do so, perform the following steps:

1. Pull the window switch up to close window completely and continue to hold the switch up for an additional two seconds after the window is closed.
2. Push the window switch down firmly to the second detent to open the window completely and continue to hold the switch down for an additional two seconds after the window is fully open.

**Wind Buffeting**

Wind buffeting can be described as the perception of pressure on the ears or a helicopter type sound in the ears. Your vehicle may exhibit wind buffeting with the windows down, or the sunroof (if equipped) in certain

open or partially open positions. This is a normal occurrence and can be minimized. If the buffeting occurs with the rear windows open, then open the front and rear windows together to minimize the buffeting. If the buffeting occurs with the sunroof open, adjust the sunroof opening to minimize the buffeting or open any window.

**LIFTGATE**

The liftgate can be unlocked or locked with the Remote Keyless Entry (RKE) transmitter or by activating the power door lock switch located on either front door trim panel.

**NOTE:** The liftgate cannot be unlocked or locked with the manual door lock plungers on the door trim panels or the door lock cylinder on the driver's door.

To open the unlocked liftgate, squeeze the handle and pull the liftgate toward you. Gas props will raise and support the liftgate in the open position.

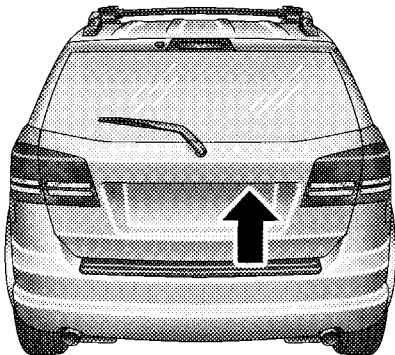

81cfe12d

### Liftgate Release

**NOTE:** Because the gas pressure drops with temperature, it may be necessary to assist the props when opening the liftgate in cold weather.

## WARNING!

- Driving with the liftgate open can allow poisonous exhaust gases into your vehicle. These fumes could injure you and your passengers. Keep the liftgate closed when you are operating the vehicle.
- If you are required to drive with the liftgate open, make sure that all windows are closed, and the blower switch on the climate control is set at high speed. **DO NOT** use the recirculation mode.

## OCCUPANT RESTRAINTS

Some of the most important safety features in your vehicle are the restraint systems. The following safety features are standard on your vehicle:

- Front airbags for both the driver and front passenger
- Supplemental side curtain airbags for the driver and passengers seated next to a window



- Supplemental front seat mounted side airbags
- An energy-absorbing steering column and steering wheel
- Knee Bolsters/Blockers for front seat occupants
- Three-point lap and shoulder belts for all seating positions
- Pretensioning and load-limiting retractors for the front seat belts to enhance occupant protection by managing occupant energy during an impact event.
- All seat belt systems (except the driver's and second row center position) include Automatic Locking Retractors (ALRs).

If you will be carrying children too small for adult-size belts, your seat belts or the Lower Anchors and Tether for Children (LATCH) feature can also be used to hold infant and child restraint systems.

**Please pay close attention to the information in this section. It tells you how to use your restraint system properly to keep you and your passengers as safe as possible.**

### **WARNING!**

**In a collision, you and your passengers can suffer much greater injuries if you are not properly buckled up. You can strike the interior of your vehicle or other passengers or you can be thrown out of the vehicle. Always be sure you and others in your vehicle are buckled up properly.**

Buckle up even though you are an excellent driver, even on short trips. Someone on the road may be a poor driver and cause a collision that includes you. This can happen far away from home or on your own street.

Research has shown that seat belts save lives, and they can reduce the seriousness of injuries in a collision. Some of the worst injuries happen when people are thrown from the vehicle. Seat belts reduce the possibility of ejection and the risk of injury caused by striking the inside of the vehicle. **Everyone** in a motor vehicle should be belted at all times.

### Lap/Shoulder Belts

All seating positions in your vehicle are equipped with lap/shoulder belts.

The belt webbing retractor is designed to lock during very sudden stops or impacts. This feature allows the shoulder part of the belt to move freely with you under normal conditions. However, in a collision, the belt will lock and reduce your risk of striking the inside of the vehicle or being thrown out.

### WARNING!

- It is extremely dangerous to ride in a cargo area, inside or outside of a vehicle. In a collision, people riding in these areas are more likely to be seriously injured or killed.
- Do not allow people to ride in any area of your vehicle that is not equipped with seats and seat belts.
- Be sure everyone in your vehicle is in a seat and using a seat belt properly.
- Wearing a seat belt incorrectly is dangerous. Seat belts are designed to go around the large bones of your body. These are the strongest parts of your body and can take the forces of a collision best.
- Wearing your belt in the wrong place could make your injuries in a collision much worse. You might suffer internal injuries, or you could even slide out of part of the belt. Follow these instructions to wear your seat belt safely and to keep your passengers safe, too.
- Two people should never be belted into a single seat belt. People belted together can crash into one another in an accident, hurting one another badly. Never use a lap/shoulder belt or a lap belt for more than one person, no matter what their size.

## Lap/Shoulder Belt Operating Instructions

1. Enter the vehicle and close the door. Sit back and adjust the front seat.
2. The seat belt latch plate is along side the pillar near the back of your seat. Grasp the latch plate and pull out the belt. Slide the latch plate up the webbing as far as necessary to make the belt go around your lap.

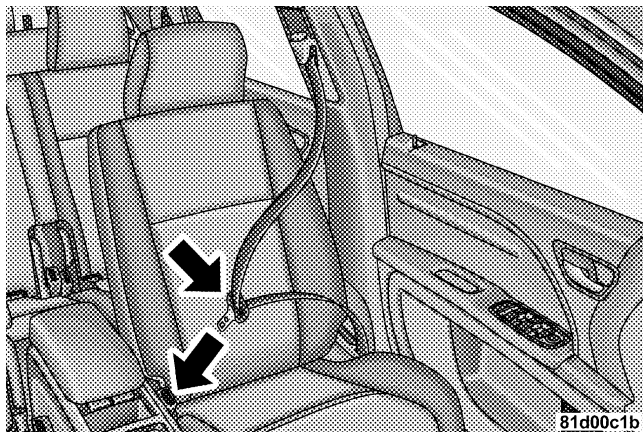

**Pulling Out Lap/Shoulder Belt**

3. When the belt is long enough to fit, insert the latch plate into the buckle until you hear a “click.”

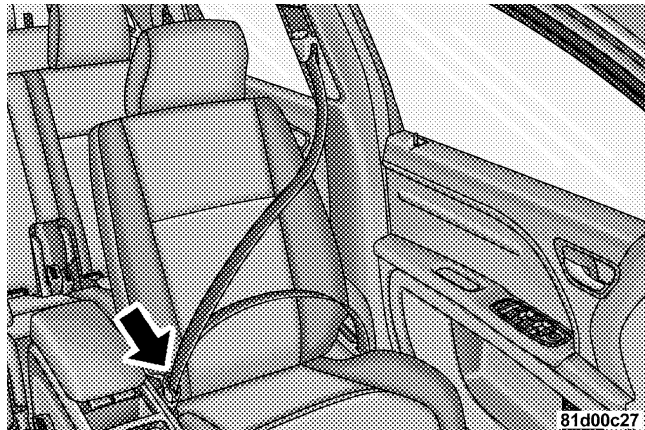

Connecting Latch Plate To Buckle

## WARNING!

- A belt that is buckled into the wrong buckle will not protect you properly. The lap portion could ride too high on your body, possibly causing internal injuries. Always buckle your belt into the buckle nearest you.
- A belt that is too loose will not protect you as well. In a sudden stop, you could move too far forward, increasing the possibility of injury. Wear your seat belt snugly.
- A belt that is worn under your arm is very dangerous. Your body could strike the inside surfaces of the vehicle in a collision, increasing head and neck injury. A belt worn under the arm can cause internal injuries. Ribs aren't as strong as shoulder bones. Wear the belt over your shoulder so that your strongest bones will take the force in a collision.
- A shoulder belt placed behind you will not protect you from injury during a collision. You are more likely to hit your head in a collision if you do not wear your shoulder belt. The lap and shoulder belt are meant to be used together.

4. Position the lap belt across your thighs, below your abdomen. To remove slack in the lap belt portion, pull up a bit on the shoulder belt. To loosen the lap belt if it is too tight, tilt the latch plate and pull on the lap belt. A snug belt reduces the risk of sliding under the belt in a collision.

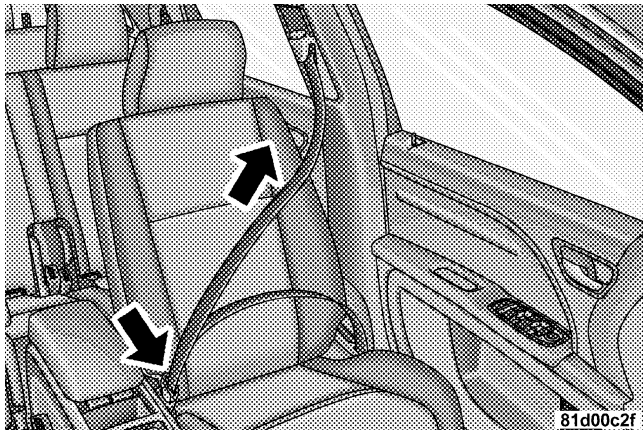

Removing Slack From Belt

## WARNING!

- A lap belt worn too high can increase the risk of internal injury in a collision. The belt forces won't be at the strong hip and pelvic bones, but across your abdomen. Always wear the lap belt as low as possible and keep it snug.
- A twisted belt can't do its job as well. In a collision, it could even cut into you. Be sure the belt is straight. If you can't straighten a belt in your vehicle, take it to your authorized dealer and have it fixed.

5. Position the shoulder belt on your chest so that it is comfortable and not resting on your neck. The retractor will withdraw any slack in the belt.

6. To release the belt, push the red button on the buckle. The belt will automatically retract to its stowed position. If necessary, slide the latch plate down the webbing to allow the belt to retract fully.

### **WARNING!**

**A frayed or torn belt could rip apart in a collision and leave you with no protection. Inspect the belt system periodically, checking for cuts, frays, or loose parts. Damaged parts must be replaced immediately. Do not disassemble or modify the system. Seat belt assemblies must be replaced after a collision if they have been damaged (bent retractor, torn webbing, etc.).**

### **Adjustable Upper Shoulder Belt Anchorage**

In the driver's seat and front passenger's seat, the shoulder belt can be adjusted upward or downward to position the belt away from your neck. Push and fully depress the button above the webbing to release the anchorage, then move it up or down to the position that fits you best.

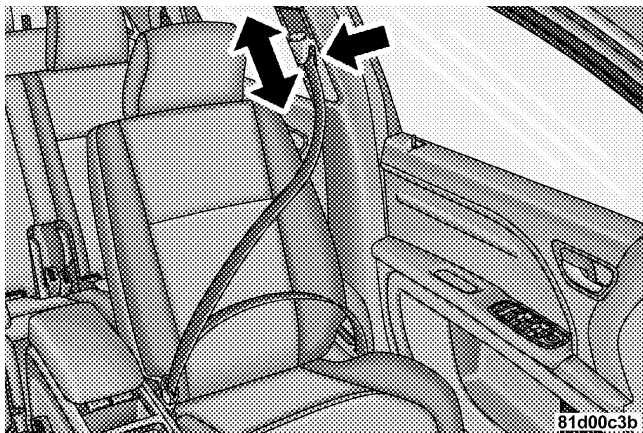

### Adjusting Upper Shoulder Belt

As a guide, if you are shorter than average you will prefer a lower position and if you are taller than average

you will prefer a higher position. When you release the anchorage try to move it up and down to make sure that it is locked in position.

In the rear seat, move toward the center of the seat to position the belt away from your neck.

### Lap/Shoulder Belt Untwisting Procedure

Use the following procedure to untwist a twisted lap/shoulder belt.

1. Position the latch plate as close as possible to the anchor point.
2. At about 6 to 12 in (15 to 30 cm) above the latch plate, grasp and twist the belt webbing 180 degrees to create a fold that begins immediately above the latch plate.
3. Slide the latch plate upward over the folded webbing. The folded webbing must enter the slot at the top of the latch plate.

4. Continue to slide the latch plate up until it clears the folded webbing.

### **Seat Belt Pretensioners**

The driver and front passenger's seat belts are equipped with pretensioning devices that are designed to remove any slack from the seat belt systems in the event of a collision. These devices improve the performance of the seat belt by assuring that the belt is tight around the occupant early in a collision. Pretensioners work for all size occupants, including those in child restraints.

**NOTE:** These devices are not a substitute for proper seat belt placement by the occupant. The seat belt must still be worn snugly and positioned properly.

The pretensioners are triggered by the Occupant Restraint Controller (ORC). Like the front airbags, the pretensioners are single use items. After a collision that is severe enough to deploy the airbags and pretensioners, both must be replaced.

### **Enhanced Seat Belt Reminder System (BeltAlert®)**

If the driver's seat belt has not been buckled within 60 seconds of starting the vehicle and if the vehicle speed is greater than 5 mph (8 km/h), the Enhanced Warning System (BeltAlert®) will alert the driver to buckle the seat belt. The driver should also instruct all other occupants to buckle their seat belts. Once the warning is triggered, the BeltAlert® will continue to chime and flash the Seat Belt Reminder Light for 96 seconds or until the driver's seat belt is buckled. The BeltAlert® will be reactivated if the driver's seat belt is unbuckled for more than 10 seconds and the vehicle speed is greater than 5 mph (8 km/h).

### **BeltAlert® Programming**

The BeltAlert® can be enabled or disabled by your authorized dealer or by performing the following steps:

**NOTE:** The manufacturer of this vehicle does not recommend deactivating the BeltAlert®.



1. With all doors closed, and the ignition switch in any position except ON or START, buckle the driver's seat belt.

2. Turn the ignition switch to the ON position, (engine does not need to be running). Wait for the Seat Belt Reminder Light to turn off and then proceed to the next step.

**NOTE:** You must perform the following steps within 60 seconds of turning the ignition switch to the ON position.

3. Unbuckle the driver's seat belt, allow the seat belt to retract, and then re-buckle the driver's seat belt at least three times, ending with the seat belt buckled.

**NOTE:** Watch for the Seat Belt Reminder Light to turn on while the seat belt retracts and turn off while re-buckling the seat belt. It may be necessary to completely retract the seat belt each time.

4. Turn the ignition switch to the LOCK position. A single chime will sound to signify that you have successfully completed the programming.

The BeltAlert® can be reactivated by repeating this procedure.

**NOTE:** When the BeltAlert® is deactivated, the Seat Belt Reminder Light will continue to illuminate as long as the driver's seat belt is unbuckled/retracted.

### **Automatic Locking Mode**

In this mode, the shoulder belt is automatically pre-locked. However, the belt will still retract to remove slack in the shoulder belt. Use The Automatic Locking mode any time a child safety seat is installed in a seating position that has a seat belt with this feature. Children 12 years old and younger should be properly restrained in the rear seat whenever possible.

### **How to Engage the Automatic Locking Mode**

1. Buckle the combination lap and shoulder belt.
2. Grasp the shoulder portion and pull downward until the entire belt is extracted.
3. Allow the belt to retract. As the belt retracts, you will here a clicking sound. This indicates the safety belt is now in the Automatic Locking mode.

### **How to Disengage the Automatic Locking Mode**

Unbuckle the combination lap and shoulder belt and allow it to retract completely to disengage the Automatic Locking mode and activate the vehicle sensitive (emergency) locking mode.

### **Seat Belts and Pregnant Women**

We recommend that pregnant women use the seat belts throughout their pregnancy. Keeping the mother safe is the best way to keep the baby safe.

Pregnant women should wear the lap part of the belt across the thighs and as snug across the hips as possible. Keep the belt low so that it does not come across the abdomen. That way the strong bones of the hips will take the force if there is a collision.

### **Seat Belt Extender**

If a seat belt is too short even when fully extended and when the adjustable upper shoulder belt anchorage (if so equipped) is in its lowest position, your authorized dealer can provide you with a seat belt extender. This extender should be used only if the existing belt is not long enough. When it is not required, remove the extender and store it.

**WARNING!**

Using a seat belt extender when not needed can increase the risk of injury in a collision. Only use when the seat belt is not long enough when it is worn low and snug and in the recommended seating positions. Remove and store the extender when not needed.

### Driver and Front Passenger Supplemental Restraint System (SRS) - Airbag

This vehicle has front airbags for both the driver and front passenger as a supplement to the seat belt restraint systems. The driver's airbag is mounted in the center of the steering wheel. The passenger's front airbag is mounted in the top of the instrument panel. The words SRS AIRBAG are embossed on the airbag covers.

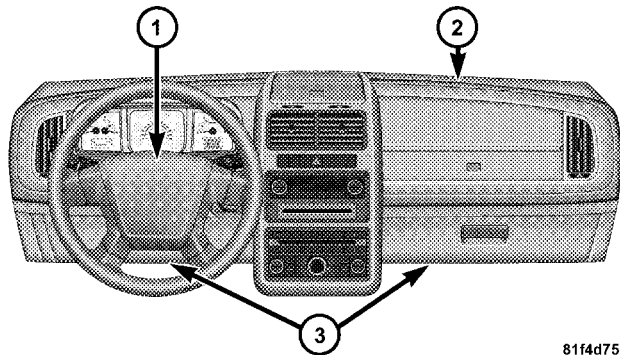

- 1 — Driver's Airbag
- 2 — Front Passenger's Airbag
- 3 — Knee Bolsters

81f4d757

**NOTE:** The front airbags are certified to the Federal regulations that allow less forceful deployment.

The front airbags have a multistage inflator design. This may allow the airbag to have different rates of inflation that are based on collision severity.

### WARNING!

- Do not put anything on or around the front airbag covers or attempt to open them. You may damage the airbags and you could be injured because the airbags are no longer functional. These protective covers for the airbag cushions are designed to open only when the airbags are inflating.
- Do not drill, cut or tamper with the knee bolster in any way.
- Do not mount any accessories to the knee bolster such as alarm lights, stereos, citizens band radios etc.

This vehicle also has supplemental side curtain airbags to protect the driver and passengers sitting next to a window and supplemental front seat mounted side airbags.

The supplemental side curtain airbags are located above the side windows. Their covers are also labeled SRS AIRBAG.

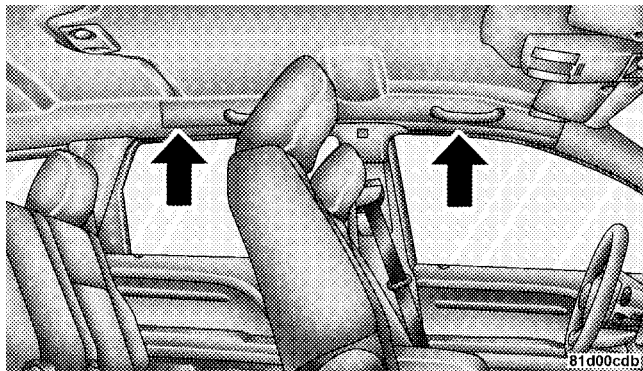

Supplemental Side Curtain Airbags

**NOTE:** Airbag covers may not be obvious in the interior trim, but they will open to allow airbag deployment.

The supplemental front seat mounted side airbags are marked with an SRS label sewn into the outboard side of the seat.

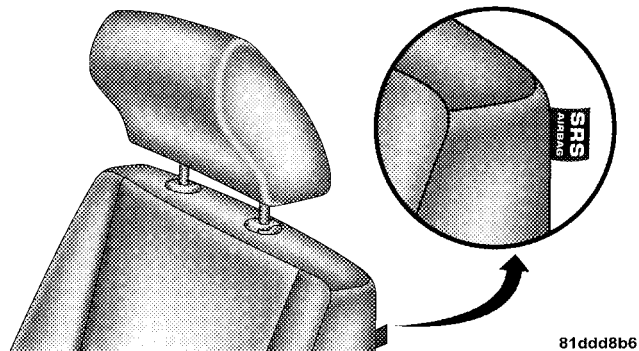

Seat Mounted Side Airbag Label

## WARNING!

- Do not stack luggage or other cargo up high enough to block the location of the side curtain airbag. The area where the side curtain airbag is located should remain free from any obstructions. Do not have any accessory items installed which will alter the roof, including adding a sunroof to your vehicle. Do not add roof racks that require permanent attachments (bolts or screws) for installation on the vehicle roof. Do not drill into the roof of the vehicle for any reason.
- Do not use accessory seat covers or place objects between you and the supplemental front seat mounted side airbags; the performance could be adversely affected and/or objects could be pushed into you, causing serious injury.
- Do not attach cupholders or any other objects on or around the door. The inflating supplemental front seat mounted side airbags could drive the object into occupants, causing serious injury.

**NOTE:** Do not use a clothing bar mounted to the coat hooks in this vehicle. A clothing bar will impede the proper performance of the curtain airbags.

Along with the seat belts, front airbags work with the instrument panel knee bolsters to provide improved protection for the driver and front passenger. Side curtain and seat airbags also work with seat belts to improve occupant protection.

While the seat belts are designed to protect you in many types of collisions, the front airbags will deploy in moderate to severe frontal collisions. The supplemental side curtain airbag and supplemental front seat mounted side airbag on the crash side of the vehicle will also trigger in moderate to severe side collisions. However, even in collisions where the airbags deploy, you need the seat belts to keep you in the correct position for the airbags to protect you properly.

**Here are some simple steps you can take to minimize the risk of harm from a deploying airbag.**

1. Children 12 years old and younger should ride buckled up in the rear seat.

**WARNING!**

**Infants in rear-facing child restraints should NEVER ride in the front seat of a vehicle with a passenger front airbag. An airbag deployment could cause severe injury or death to infants in that position.**

2. Children who are not big enough to wear the vehicle seat belt properly should be secured in the rear seat in child restraints or belt-positioning booster seats. (Refer to information on Child Restraint in this section)

3. Older children who do not use child restraints or belt-positioning booster seats should ride properly buckled up in the rear seat. Never allow children to slide the shoulder belt behind them or under their arm.
4. If a child from 1 to 12 years old must ride in the front passenger's seat because the vehicle is crowded, move the seat as far back as possible and use the proper child restraint. (Refer to information on Child Restraint in this section.)
5. You should read the instructions provided with your child restraint to make sure that you are using it properly.
6. All occupants should use their seat belts properly.
7. The driver's seat and front passenger's seat should be moved back as far as practical to allow the airbags time to inflate.
8. Do not lean against the door, as the supplemental side curtain airbags and supplemental front seat mounted side airbags will inflate forcefully into the space between you and the door.
9. If the airbag system in this vehicle needs to be modified to accommodate a disabled person, contact the Customer Center. Phone numbers are provided in the "If You Need Customer Assistance" section.

**WARNING!**

- **Relying on the airbags alone could lead to more severe injuries in a collision. The airbags work with your seat belt to restrain you properly. In some collisions, the airbags won't deploy at all. Always wear your seat belts even though you have airbags.**
- **Being too close to the steering wheel or instrument panel during airbag deployment could cause serious injury. Airbags need room to inflate. Sit back, comfortably extending your arms to reach the steering wheel or instrument panel.**
- **Supplemental side curtain airbags and supplemental front seat mounted side airbags also need room to inflate. Do not lean against the door or window. Sit upright in the center of the seat.**

**Airbag System Components**

The airbag system consists of the following:

- Occupant Restraint Controller (ORC)
- Side Remote Pressure and Acceleration Sensors
- Airbag Warning Light
- Driver Airbag
- Front Passenger Airbag
- Supplemental Side Curtain Airbags
- Supplemental Front Seat Mounted Side Airbags
- Steering Wheel and Column
- Instrument Panel
- Interconnecting Wiring
- Seat Belt Reminder Light



- Knee Impact Bolsters
- Front Acceleration Sensors
- Front Seat Belt Retractor Pretensioners
- Front Seat Track Position Sensors

### How the Airbag System Works

- The **Occupant Restraint Controller (ORC)** determines if a frontal collision is severe enough to require the airbags to inflate. If airbags are required, the ORC determines the necessary rate of airbag inflation for that event.
- The ORC determines if a side impact is severe enough to deploy the supplemental side curtain airbag and supplemental front seat mounted side airbag.
- The ORC detects rollover.

- The ORC and other systems monitor the readiness of the electronic components whenever the ignition switch is in the START or ON position. These include all of the items listed above except the knee impact bolsters, the instrument panel, and the steering wheel and column. Furthermore, the airbag system is not active if the key is in the LOCK position, the ACC position, or not in the ignition.



- The ORC commands Airbag Warning Light operation. The Airbag Warning Light in the instrument panel turns on for four to six seconds as a self-check when the ignition is first turned on. After the self-check, the light will turn off. If the ORC detects a malfunction in any part of the system, the light will turn on until the malfunction is corrected. A single chime will sound if the light comes on again after initial start-up.

**WARNING!**

**Ignoring the Airbag Warning Light in your instrument panel could mean you won't have the airbags to protect you in a collision. If the light does not come on, stays on after you start the vehicle, or if it comes on as you drive, have the airbag system checked right away.**

- The **Driver and Front Passenger Airbag/Inflator Units** are located in the center of the steering wheel and the passenger's side of the instrument panel. When the ORC detects a collision requiring the airbags, it signals the inflator units. A large quantity of nontoxic gas is generated to inflate the front airbags. Different airbag inflation rates may be possible based on collision severity. The steering wheel hub trim cover and the upper passenger's side of the instrument panel separate and fold out of the way as the bags inflate to their full size. The bags fully inflate in about 50 to 70 ms. This is about half of the time that it takes to blink your eyes. The bags then quickly deflate while helping to restrain the driver and front passenger. The driver's front airbag gas is vented through vent holes in the sides of the airbag. The passenger's front airbag gas is vented through vent holes in the sides of the airbag. In this way, the airbags do not interfere with your control of the vehicle.
- The **Knee Impact Bolsters** help protect the knees of the driver and the front passenger and position everyone for the best interaction with the front airbag.
- The **Supplemental Side Impact SRS Side Curtain Airbags** are designed to activate only in certain side collisions. When the ORC detects a collision requiring the side curtain airbag to inflate, it signals the inflators on the crash side of the vehicle. A quantity of nontoxic

gas is generated to inflate the side curtain airbag. The inflating side curtain airbag pushes the outside edge of the headliner out of the way and covers the window. The airbag inflates in about 30 ms (about one-quarter of the time that it takes to blink your eyes) with enough force to injure you if you are not belted and seated properly, or if items are positioned in the area where the side curtain airbag inflates. This especially applies to children. The side curtain airbag is only about 3-1/2 in (9 cm) thick when it is inflated.

- The **Supplemental Front Seat Mounted Side Airbags** are designed to activate only in certain side collisions. When the ORC (with side impact option) detects a collision requiring the front seat mounted side airbag to inflate, it signals the inflators on the crash side of the vehicle. A quantity of nontoxic gas is generated to inflate the front seat mounted side airbag. The inflating front seat mounted side airbag pushes through the

seam in the seat's trim cover and opens into the space between the occupant and the door. The airbag inflates at a very high speed and with enough force to injure you if you are not belted and seated properly, or if items are positioned in the area where the front seat mounted side airbag inflates. This especially applies to children.

The following requirements must be strictly adhered to:

- Do not make any modifications to the front seat components, assembly, or to the seat cover in any way.
- Do not use prior or future model year seat covers not designated for the specific model being repaired. Always use the correct seat cover specified for the vehicle.

- Do not replace the seat cover with an aftermarket seat cover.
- Do not add a secondary seat cover other than those approved by the manufacturer of this vehicle/Mopar®.
- At no time should any supplemental restraint system (SRS) component or SRS-related component or fastener be modified or replaced with any part except those, which are approved by the manufacturer of this vehicle/Mopar®.

**WARNING!**

**Unapproved modifications or service procedures to the front seat assembly, its related components, or seat cover may inadvertently change the airbag deployment in case of a frontal crash. This could result in death or serious injury to the driver or front seat passenger if the vehicle is involved in an accident. A modified vehicle may not comply with required Federal Motor Vehicle Safety Standards (FMVSS).**

## If a Deployment Occurs

The airbag system is designed to deploy when the ORC detects a moderate to severe collision to help restrain the driver and front passenger and then to immediately deflate.

**NOTE:** A frontal collision that is not severe enough to need airbag protection will not activate the system. This does not mean something is wrong with the airbag system.

If you do have a collision that deploys the airbags, any or all of the following may occur:

- The nylon airbag material may sometimes cause abrasions and/or skin reddening to the driver and front passenger as the airbags deploy and unfold. The abrasions are similar to friction rope burns or those you might get sliding along a carpet or gymnasium floor. They are not caused by contact with chemicals. They are not permanent and normally heal quickly.

However, if you haven't healed significantly within a few days or if you have any blistering, see your doctor immediately.

- As the airbags deflate, you may see some smoke-like particles. The particles are a normal by-product of the process that generates the nontoxic gas used for airbag inflation. These airborne particles may irritate the skin, eyes, nose, or throat. If you have skin or eye irritation, rinse the area with cool water. For nose or throat irritation, move to fresh air. If the irritation continues, see your doctor. If these particles settle on your clothing, follow the garment manufacturer's instructions for cleaning.
- It is not advisable to drive your vehicle after the airbags have been deployed. If you are involved in another collision, the airbags will not be in place to protect you.

**WARNING!**

**Deployed airbags and seat belt pretensioners cannot protect you in another collision. Have the airbags, seat belt pretensioner, and seat belt retractor assembly replaced by an authorized dealer as soon as possible.**

**Enhanced Accident Response System**

In the event of an impact that causes airbag deployment, with the vehicle communication network intact, and the power intact, the Enhanced Accident Response System performs the following functions:

- Cuts off fuel to the engine.
- Flashes hazard lights.
- Turns on the interior lights, which remain on as long as the battery has power or until the ignition key is removed.
- Unlocks the doors automatically.

**NOTE:** The interior lights can only be deactivated if the key is removed from the ignition switch or the vehicle is driven.

## Maintaining Your Airbag System

### WARNING!

- **Modifications to any part of the airbag system could cause it to fail when you need it. You could be injured because the airbags are not there to protect you. Do not modify the components or wiring, including adding any kind of badges or stickers to the steering wheel hub trim cover or the upper passenger's side of the instrument panel. Do not modify the front bumper, vehicle body structure, or frame.**
- **You need proper knee impact protection in a collision. Do not mount or locate any aftermarket equipment on or behind the knee impact bolster.**
- **It is dangerous to try to repair any part of the airbag system yourself. Be sure to tell anyone who works on your vehicle that it has airbags.**

**NOTE:** Perchlorate Material — special handling may apply. See [www.dtsc.ca.gov/hazardouswaste/perchlorate](http://www.dtsc.ca.gov/hazardouswaste/perchlorate).

### Airbag Warning Light



You will want to have the airbags ready to inflate for your protection in an impact. While the airbag system is designed to be maintenance free, if any of the following occurs, have an authorized dealer service the system promptly:

- The Airbag Warning Light does not come on or flickers during the four to six seconds when the ignition switch is first turned ON.
- The light remains on or flickers after the four to six second interval.
- The light flickers or comes on and remains on while driving.

### **Event Data Recorder (EDR)**

In the event of an accident, your vehicle is designed to record up to five seconds of specific vehicle data parameters (see the following list) in an event data recorder prior to the moment of airbag deployment, or near deployment, and up to a quarter second of high-speed deceleration data during and/or after airbag deployment. EDR data are **ONLY** recorded if an airbag deploys, or nearly deploys, and are otherwise unavailable.

#### **NOTE:**

1. A near-deployment event occurs when the airbag sensor detects severe vehicle deceleration usually indicative of a crash, but not severe enough to warrant airbag deployment.
2. Under certain circumstances, EDR data may not be recorded (e.g., loss of battery power).

In conjunction with other data gathered during a complete accident investigation, the electronic data may be

used by the manufacturer of this vehicle and others to learn more about the possible causes of crashes and associated injuries in order to assess and improve vehicle performance. In addition to crash investigations initiated by the manufacturer of this vehicle, such investigations may be requested by customers, insurance carriers, government officials, and professional crash researchers, such as those associated with universities, and with hospital and insurance organizations.

In the event that an investigation is undertaken by the manufacturer of this vehicle (regardless of initiative), the company or its designated representative will first obtain permission of the appropriate custodial entity for the vehicle (usually the vehicle owner or lessee) before accessing the electronic data stored, unless ordered to download data by a court with legal jurisdiction (i.e., pursuant to a warrant). A copy of the data will be provided to the custodial entity upon request. General data that does not identify particular vehicles or crashes



may be released for incorporation in aggregate crash databases, such as those maintained by the U.S. government and various states. Data of a potentially sensitive nature, such as would identify a particular driver, vehicle, or crash, will be treated confidentially. Confidential data will not be disclosed by the manufacturer of this vehicle to any third party except when:

1. Used for research purposes, such as to match data with a particular crash record in an aggregate database, provided confidentiality of personal data is thereafter preserved
2. Used in defense of litigation involving a product of the manufacturer of this vehicle
3. Requested by police under a legal warrant
4. Otherwise required by law

Data Parameters that May Be Recorded:

- Diagnostic trouble code(s) and warning light status for electronically-controlled safety systems, including the airbag system
- Airbag disable light status (if equipped)
- "Time" of airbag deployment (in terms of ignition cycles and vehicle mileage)
- Airbag deployment level (if applicable)
- Impact acceleration and angle
- Seat belt status
- Brake status (service and parking brakes)
- Accelerator status (including vehicle speed)
- Engine control status (including engine speed)
- Transaxle gear selection
- Cruise control status

- Traction/stability control status
- Tire Pressure Monitoring System status (if equipped)

### **Child Restraint**

Everyone in your vehicle needs to be buckled up all the time, including babies and children. Every state in the United States and all Canadian provinces require that small children ride in proper restraint systems. This is the law, and you can be prosecuted for ignoring it.

Children 12 years and younger should ride properly buckled up in a rear seat, if available. According to crash statistics, children are safer when properly restrained in the rear seats rather than in the front.

### **WARNING!**

**In a collision, an unrestrained child, even a tiny baby, can become a missile inside the vehicle. The force required to hold even an infant on your lap could become so great that you could not hold the child, no matter how strong you are. The child and others could be badly injured. Any child riding in your vehicle should be in a proper restraint for the child's size.**

There are different sizes and types of restraints for children from newborn size to the child almost large enough for an adult safety belt. Always check the child seat Owner's Manual to ensure you have the correct seat for your child. Use the restraint that is correct for your child.

## Infants and Child Restraints

- Safety experts recommend that children ride rearward-facing in the vehicle until they are at least one year old **and** weigh at least 20 lbs (9 kg). Two types of child restraints can be used rearward-facing, infant carriers and convertible child seats.
- The infant carrier is only used rearward-facing in the vehicle. It is recommended for children who weigh up to about 20 lbs (9 kg). Convertible child seats can be used either rearward-facing or forward-facing in the vehicle. Convertible child seats often have a higher weight limit in the rearward-facing direction than infant carriers do, so they can be used rearward-facing by children who weigh more than 20 lbs (9 kg) but are less than one year old. Both types of child restraints are held in the vehicle by the lap/shoulder belt or the LATCH child restraint anchor system. Refer to

“LATCH — Child Seat Anchor System (Lower Anchors and Tether for Children)” in this section.

- Rearward-facing child seats must **NEVER** be used in the front seat of a vehicle with the front passenger airbag unless the airbag is turned off. An airbag deployment could cause severe injury or death to infants in this position.

## Older Children and Child Restraints

Children who weigh more than 20 lbs (9 kg) and who are older than one year can ride forward-facing in the vehicle. Forward-facing child seats and convertible child seats used in the forward-facing direction are for children who weigh 20 to 40 lbs (9 to 18 kg) and who are older than one year. These child seats are also held in the vehicle by the lap/shoulder belt or the LATCH child restraint anchorage system. Refer to “LATCH — Child Seat Anchorage System (Lower Anchors and Tether for Children)” in this section.

The belt-positioning booster seat is for children weighing more than 40 lbs (18 kg), but who are still too small to fit the vehicle's seat belts properly. If the child cannot sit with knees bent over the vehicle's seat cushion while the child's back is against the seatback, they should use a belt-positioning booster seat. The child and belt-positioning booster seat are held in the vehicle by the lap/shoulder belt.

### **Children too Large for Booster Seats**

Children who are large enough to wear the shoulder belt comfortably and whose legs are long enough to bend over the front of the seat when their back is against the seatback should use the lap/shoulder belt in a rear seat.

- Make sure that the child is upright in the seat.
- The lap portion should be low on the hips and as snug as possible.

- Check belt fit periodically. A child's squirming or slouching can move the belt out of position.
- If the shoulder belt contacts the face or neck, move the child closer to the center of the vehicle. Never allow a child to put the shoulder belt under an arm or behind their back.

**NOTE:** For additional information, refer to [www.seatcheck.org](http://www.seatcheck.org) or call 1-866-SEATCHECK.

**WARNING!**

- **Improper installation can lead to failure of an infant or child restraint. It could come loose in a collision. The child could be badly injured or killed. Follow the manufacturer's directions exactly when installing an infant or child restraint.**
- **A rearward-facing child restraint should only be used in a rear seat. A rearward-facing child restraint in the front seat may be struck by a deploying passenger airbag, which may cause severe or fatal injury to the infant.**

**Here are some tips on getting the most out of your child restraint:**

- Before buying any restraint system, make sure that it has a label certifying that it meets all applicable Safety

Standards. We also recommend that you make sure that you can install the child restraint in the vehicle where you will use it before you buy it.

- The restraint must be appropriate for your child's weight and height. Check the label on the restraint for weight and height limits.
- Carefully follow the instructions that come with the restraint. If you install the restraint improperly, it may not work when you need it.
- Buckle the child into the seat according to the child restraint manufacturer's directions.
- When your child restraint is not in use, secure it in the vehicle with the seat belt or remove it from the vehicle. Do not leave it loose in the vehicle. In a sudden stop or collision, it could strike the occupants or seatbacks and cause serious personal injury.

### **LATCH — Child Seat Anchor System (Lower Anchors and Tether for Children)**

Your vehicle's second row passenger seats are equipped with the child restraint anchor system called LATCH. The LATCH system provides for the installation of the child restraint without using the vehicle's seat belts, instead securing the child restraint using lower anchors and upper tether straps from the child restraint to the vehicle structure.

LATCH-compatible child restraint systems are now available. However, because the lower anchors are to be introduced over a period of years, child restraint systems having attachments for those anchors will continue to have features for installation using the vehicle's seat belts. Child restraints having tether straps and hooks for

connection to the top tether anchors have been available for some time. For some older child restraints, many child restraint manufacturers offer add-on tether strap kits or retrofit kits. You are urged to take advantage of all the available attachments provided with your child restraint in any vehicle.

All three second-row passenger seating positions have lower anchors that are capable of accommodating LATCH-compatible child seats. You should **NEVER** install LATCH-compatible child seats so that two seats share a common lower anchorage. If installing child seats in adjacent seating positions, or if your child restraints are not LATCH-compatible, install the restraints using the vehicle's seat belts.

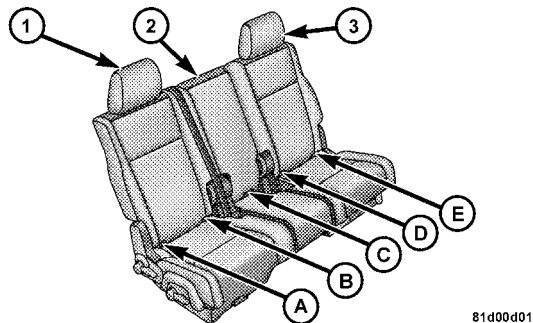

81d00d01

### Latch Anchorages

1 — Outer 60% Seating Position. Use Lower Anchor Loops A and B. If placing a second child seat in the vehicle, use the Outer 40% Seating Position and Lower Anchor Loops D and E. **DO NOT USE** Middle 60% Seating Position and Lower Anchorage Loops B and C.

2 — Middle 60% Seating Position. Use Lower Anchor Loops B and C. If placing a second child seat in the vehicle, use the Outer 40% Seating Position and Lower Anchor Loops D and E. **DO NOT USE** Outer 60% Seating Position and Lower Anchor Loops A and B.

3 — Outer 40% Seating Position. Use Lower Anchor Loops D and E. If placing a second child seat in the vehicle, use Outer 60% Seating Position and Lower Anchor Loops A and B or Middle 60% Seating Position and Lower Anchor Loops B and C.

### Installing the LATCH-Compatible Child Restraint System

We urge you to follow the manufacturer's directions carefully when installing your child restraint. Not all child restraint systems will be installed as described here. Again, carefully follow the installation instructions that are provided with the child restraint system.



The lower anchors are round bars located at the rear of the seat cushion where it meets the seatback and are just visible when you lean into the rear seat to install the child restraint.

You will easily feel them if you run your finger along the intersection of the seatback and seat cushion surfaces.

In addition, there are tether strap anchors located behind each rear seatback, near to the floor.

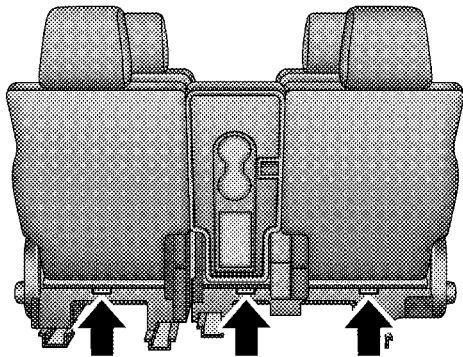

81ddf905

### Tether Strap Anchors

Many, but not all restraint systems will be equipped with separate straps on each side, with each having a hook or connector for attachment to the lower anchor and a

means of adjusting the tension in the strap. Forward-facing toddler restraints and some rear-facing infant restraints will also be equipped with a tether strap, a hook for attachment to the tether strap anchor and a means of adjusting the tension of the strap.

You will first loosen the adjusters on the lower straps and on the tether strap so that you can more easily attach the hooks or connectors to the vehicle anchors. Next, attach the lower hooks or connectors over the top of the seatcover material. Then attach the tether strap to the anchor directly behind the seat where you are placing the child restraint, being careful to route the tether strap to provide the most direct path between the anchor and the child restraint, preferably between the head restraint posts underneath the head restraint. Finally, tighten all three straps as you push the child restraint rearward and downward into the seat, removing slack in the straps according to the child restraint manufacturer's instructions.



**NOTE:**

- Ensure that the tether strap does not slip into the opening between the seatbacks as you remove slack in the strap.
- When using the LATCH attaching system to install a child restraint, please ensure that all seat belts not being used for occupant restraints are stowed and out of reach of children. It is recommended that before installing the child restraint, buckle the seat belt so the seat belt is tucked behind the child restraint. This should stow the seat belt out of the reach of an inquisitive child. Remind all children in the vehicle that the seat belts are not toys and that they should not play with them. In addition, never leave unattended children in the vehicle.

**WARNING!**

**Improper installation of a child restraint to the LATCH anchorages can lead to failure of an infant or child restraint. The child could be badly injured or killed. Follow the manufacturer's directions exactly when installing an infant or child restraint.**

2

**Installing Child Restraints Using the Vehicle Seat Belt**

The seat belts in the passenger seating positions are equipped with either an Automatic Locking Retractor (ALR) or a cinching latch plate or both. Both types of seat belts are designed to keep the lap portion of the seat belt tight around the child restraint so that it is not necessary to use a locking clip. The ALR will make a ratcheting noise if you extract the entire belt from the retractor and

then allow the belt to retract into the retractor. For additional information on ALR, refer to “Automatic Locking Mode” in this section.

To install a child restraint, first, pull enough of the seat belt webbing from the retractor to route it through the belt path of the child restraint and slide the latch plate into the buckle. Next, extract all the seat belt webbing out of the retractor and then allow the belt to retract into the retractor. Finally, pull on any excess webbing to tighten the lap portion around the child restraint. Any seat belt system will loosen with time, so check the belt occasionally, and pull it tight if necessary.

To attach a child restraint tether strap:

- Route the tether strap to provide the most direct path for the strap between the anchor and the child seat, preferably between the head restraint posts underneath the head restraint.

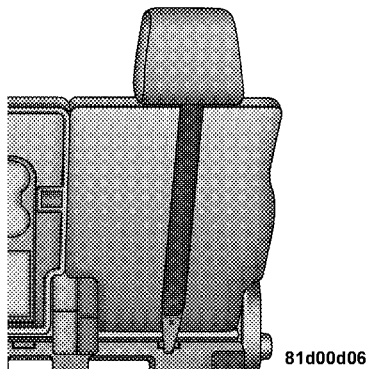

81d00d06

**Tether Strap Mounting**

- If necessary, move the seat forward to provide better access to the tether anchor.

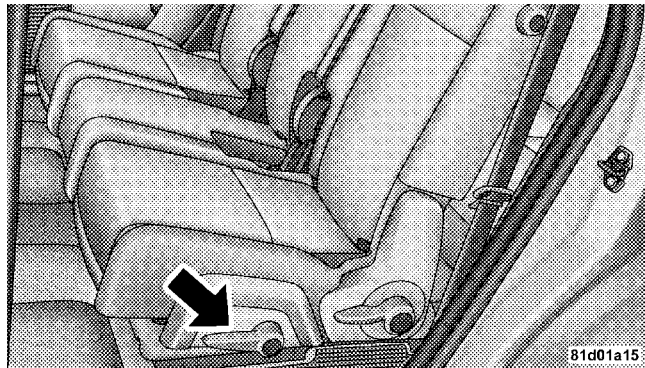

**Seat Track Release Lever**

- Attach the tether strap hook of the child restraint to the tether anchor and remove slack in the tether strap according to the child restraint manufacturer's instructions.

**NOTE:** Ensure that the tether strap does not slip into the opening between the seatbacks as you remove slack in the strap.

### **WARNING!**

An incorrectly anchored tether strap could lead to increased head motion and possible injury to the child. Use only the anchor positions directly behind the child seat to secure a child restraint top tether strap.

### **Transporting Pets**

Airbags deploying in the front seat could harm your pet. An unrestrained pet will be thrown about and possibly injured, or injure a passenger during panic braking or in a collision.

Pets should be restrained in the rear seat in pet harnesses or pet carriers that are secured by seat belts.

### **ENGINE BREAK-IN RECOMMENDATIONS**

A long break-in period is not required for the engine in your vehicle.

Drive moderately during the first 300 mi (500 km). After the initial 60 mi (100 km), speeds up to 50 or 55 mph (80 or 90 km/h) are desirable.

While cruising, brief full-throttle acceleration, within the limits of local traffic laws, contributes to a good break-in. Wide-open throttle acceleration in low gear can be detrimental and should be avoided.

The engine oil installed in the engine at the factory is a high-quality energy-conserving type lubricant. Oil

changes should be consistent with anticipated climate conditions under which vehicle operations will occur. For the recommended viscosity and quality grades, refer to “Maintenance Procedures” in Section 7. **NON-DETERGENT OR STRAIGHT MINERAL OILS MUST NEVER BE USED.**

A new engine may consume some oil during its first few thousand miles (kilometers) of operation. This should be considered as a normal part of the break-in and not interpreted as an indication of difficulty.

### **SAFETY TIPS**

#### **Transporting Passengers**

**NEVER TRANSPORT PASSENGERS IN THE CARGO AREA.**

**WARNING!**

- It is extremely dangerous to ride in a cargo area, inside or outside of a vehicle. In a collision, people riding in these areas are more likely to be seriously injured or killed.
- Do not allow people to ride in any area of your vehicle that is not equipped with seats and seat belts.
- Be sure everyone in your vehicle is in a seat and using a seat belt properly.
- On seven passenger models, do not drive the vehicle with the second row passenger seat in the easy entry/exit position (seat cushion flipped upward and seat moved forward), as this position is only intended for entering and exiting the third row seats. Failure to follow this warning may result in personal injury.
- On seven passenger models, do not allow a passenger to sit in a third row seat with the second row seatback(s) folded flat. In a collision, the passenger could slide underneath the seat belt and be seriously or even fatally injured.

**Lock Your Vehicle**

Always remove the key from the ignition and lock all doors when leaving the vehicle unattended, even in your own driveway or garage. Try to park your vehicle in a well-lit area and never invite theft by leaving articles of value exposed.

**Exhaust Gas****WARNING!**

- Exhaust gases can injure or kill. They contain carbon monoxide (CO), which is colorless and odorless. Breathing it can make you unconscious and can eventually poison you. To avoid breathing CO follow these safety tips:

Do not run the engine in a closed garage or in confined areas any longer than needed to move your vehicle in or out of the area.

If it is necessary to sit in a parked vehicle with the engine running, adjust your heating or cooling controls to force outside air into the vehicle. Set the blower at high speed.

If you are required to drive with the liftgate open, make sure that all windows are closed, and the BLOWER switch on the climate control is set at high speed. DO NOT use the recirculation mode.

The best protection against carbon monoxide entry into the vehicle body is a properly maintained engine exhaust system.

Whenever a change is noticed in the sound of the exhaust system, when exhaust fumes can be detected inside the vehicle, or when the underside or rear of the vehicle is damaged, have a competent mechanic inspect the complete exhaust system and adjacent body areas for broken, damaged, deteriorated, or mispositioned parts. Open seams or loose connections could permit exhaust fumes to seep into the passenger compartment. In addition,

inspect the exhaust system each time the vehicle is raised for lubrication or oil change. Replace as required.

### **Safety Checks You Should Make Inside The Vehicle**

#### **Seat Belts**

Inspect the seat belt system periodically, checking for cuts, frays, and loose parts. Damaged parts must be replaced immediately. Do not disassemble or modify the system.

Front seat belt assemblies must be replaced after a collision. Rear seat belt assemblies must be replaced after a collision if they have been damaged (i.e., bent retractor, torn webbing, etc.). If there is any question regarding belt or retractor condition, replace the seat belt.

#### **Airbag Warning Light**

The light should turn on and remain on for four to six seconds as a bulb check when the ignition switch is first

turned ON. If the light is not lit during starting, or if the light stays on, flickers, or turns on while driving, have the system checked by an authorized dealer.

### **Defroster**

Check operation by selecting the defrost mode and place the blower control on high speed. You should be able to feel the air directed against the windshield. See your authorized dealer for service if your defroster is inoperable.

## **Periodic Safety Checks You Should Make Outside The Vehicle**

### **Tires**

Examine tires for excessive tread wear and uneven wear patterns. Check for stones, nails, glass, or other objects lodged in the tread. Inspect the tread and sidewall for cuts and cracks. Check the wheel nuts for tightness. Check the tires (including spare) for proper pressure.

### **Lights**

Have someone observe the operation of exterior lights while you work the controls. Check Turn Signal and High Beam Indicator Lights on the instrument panel.

### **Door Latches**

Check for positive closing, latching, and locking.

### **Fluid Leaks**

Check area under vehicle after overnight parking for fuel, engine coolant, oil, or other fluid leaks. Also, if gasoline fumes are detected or if fuel, power steering fluid, or brake fluid leaks are suspected, the cause should be located and corrected immediately.





# UNDERSTANDING THE FEATURES OF YOUR VEHICLE

## CONTENTS

---

■ Mirrors . . . . .	.84	□ Illuminated Vanity Mirrors — If Equipped . . .	.87
□ Inside Day/Night Mirror . . . . .	.84	■ Parkview® Rear Backup Camera — If Equipped .	.88
□ Automatic Dimming Inside Mirror — If Equipped . . . . .	.85	■ Hands-Free Communication (UConnect®) — If Equipped . . . . .	.89
□ Outside Mirrors . . . . .	.85	□ Operation . . . . .	.91
□ Outside Mirrors Folding Feature — If Equipped . . . . .	.86	□ Phone Call Features . . . . .	.98
□ Power Remote Control Mirrors . . . . .	.86	□ UConnect® System Features . . . . .	101
□ Heated Remote Control Mirrors — If Equipped . . . . .	.87	□ Advanced Phone Connectivity . . . . .	105
		□ Things You Should Know About Your UConnect® System . . . . .	107

- General Information . . . . . 116
- Voice Recognition System — If Equipped . . . . . 116
  - Voice Recognition System (VR) Operation . . . . . 116
  - Commands . . . . . 117
  - Voice Training . . . . . 120
- Seats . . . . . 121
  - Manual Front Seat Adjustments . . . . . 121
  - Power Seat — If Equipped . . . . . 126
  - Head Restraints . . . . . 127
  - Heated Seats — If Equipped . . . . . 129
  - 60/40 Split Second-Row Passenger Seats . . . . . 130
  - 50/50 Split Third-Row Passenger Seats With Fold-Flat Feature — Seven Passenger Models . . . . . 140
- To Open And Close The Hood . . . . . 142
- Lights . . . . . 144
  - Exterior And Interior Lighting Control . . . . . 144
  - Headlights And Parking Lights . . . . . 144
    - Automatic Headlights — If Equipped . . . . . 145
    - Headlights With Wipers (Available With Auto Headlights Only) . . . . . 145
    - Headlight Time Delay — If Equipped . . . . . 145
    - Daytime Running Lights (DRL) — If Equipped . . . . . 146
  - Lights-On Reminder . . . . . 146
  - Fog Lights — If Equipped . . . . . 146
  - Turn Signals . . . . . 147
  - Highbeam/Lowbeam Select Switch . . . . . 148

- Flash To Pass . . . . . 149
- Interior Lights . . . . . 149
- Windshield Wipers And Washers . . . . . 151
  - Intermittent Wiper System . . . . . 153
  - Mist Feature . . . . . 153
  - Headlights With Wipers (Available With Auto Headlights Only) . . . . . 154
  - Windshield Washers . . . . . 154
  - Adding Washer Fluid . . . . . 155
- Tilt/Telescoping Steering Column — If Equipped . . . . . 156
- Electronic Speed Control — If Equipped . . . . . 157
  - Electronic Speed Control Operation . . . . . 157
  - To Activate . . . . . 157

- To Set At A Desired Speed . . . . . 158
- To Deactivate . . . . . 158
- To Resume Speed . . . . . 158
- To Vary The Speed Setting . . . . . 159
- To Accelerate For Passing . . . . . 159
- Overhead Console . . . . . 160
  - Courtesy/Reading Lights . . . . . 161
  - Sunglasses Storage . . . . . 161
  - Interior Observation Mirror . . . . . 161
  - Power Sunroof Switch — If Equipped . . . . . 161
- Garage Door Opener — If Equipped . . . . . 161
  - Programming HomeLink® . . . . . 163
  - Gate Operator/Canadian Programming . . . . . 165

- Using HomeLink® . . . . . 166
- Reprogramming A Single HomeLink® Button . . . . . 166
- Security . . . . . 167
- Troubleshooting Tips . . . . . 167
- General Information . . . . . 167
- Power Sunroof — If Equipped . . . . . 168
  - Opening Sunroof - Manually . . . . . 169
  - Opening Sunroof - Express . . . . . 169
  - Closing Sunroof - Manually . . . . . 169
  - Closing Sunroof - Express . . . . . 170
  - Pinch Protect Feature . . . . . 170
  - Pinch Protect Override . . . . . 170
  - Venting Sunroof - Express . . . . . 170
  - Sunshade Operation . . . . . 171
  - Wind Buffeting . . . . . 171
  - Sunroof Maintenance . . . . . 171
  - Ignition Off Operation . . . . . 171
  - Sunroof Fully Closed . . . . . 172
- Electrical Power Outlets . . . . . 172
  - Electrical Outlet Use With Engine Off . . . . . 174
- Power Inverter — If Equipped . . . . . 174
- Cup And Bottle Holders . . . . . 176
  - Cupholders . . . . . 176
  - Bottle Holders . . . . . 177

- Storage . . . . .178
  - Beverage Cooler/Storage Compartment — If Equipped . . . . .178
  - Instrument Panel Storage Compartment — If Equipped . . . . .180
  - Center Console Storage . . . . .181
  - Flip 'n Stow™ Front Passenger Seat Storage — If Equipped . . . . .182
  - Second-Row Passenger Seat Temporary Storage Bin . . . . .183
  - Second-Row Map Pocket And Grocery Retainers . . . . .184

- In-Floor Storage Bin With Removable Liner . . . .184
- Cargo Area Features . . . . .186
  - Rechargeable Flashlight — If Equipped . . . . .186
  - Cargo Management System . . . . .186
- Rear Window Features . . . . .191
  - Rear Window Wiper/Washer — If Equipped . .191
  - Rear Window Defroster — If Equipped . . . . .193
- Roof Luggage Rack — If Equipped . . . . .194

## MIRRORS

### Inside Day/Night Mirror

Adjust the mirror to center on the view through the rear window. A two-point pivot system allows for horizontal and vertical mirror adjustment.

Annoying headlight glare can be reduced by moving the small control under the mirror to the night position (toward the rear of the vehicle). The mirror should be adjusted while set in the day position (toward the windshield).

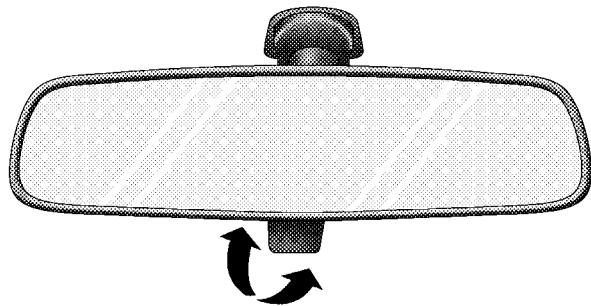

81f4d4ad

**Manual Rearview Mirror**

**Automatic Dimming Inside Mirror — If Equipped**

This mirror automatically adjusts for annoying headlight glare from vehicles behind you. You can turn the feature on or off by pressing the button at the base of the mirror. A light will illuminate next to the switch when the automatic dimming feature is activated.

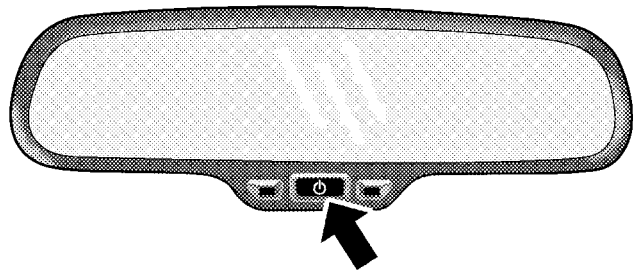

81f1be98

**Automatic Dimming Mirror****CAUTION!**

**To avoid damage to the mirror during cleaning, never spray any cleaning solution directly onto the mirror. Apply the solution onto a clean cloth and wipe the mirror clean.**

**3****Outside Mirrors**

To receive maximum benefit, adjust the outside mirror(s) to center on the adjacent lane of traffic and a slight overlap of the view obtained from the inside mirror.

**NOTE:** The passenger-side convex outside mirror will give a much wider view to the rear, and especially of the lane next to your vehicle.

**WARNING!**

Vehicles and other objects seen in the passenger-side convex mirror will look smaller and farther away than they really are. Relying too much on your passenger-side convex mirror could cause you to collide with another vehicle or other object. Use your inside mirror when judging the size or distance of a vehicle seen in the passenger-side convex mirror. Failure to follow this warning may result in serious injury or death.

**Outside Mirrors Folding Feature — If Equipped**

Some models have exterior mirrors that are hinged. The hinge allows the mirror to pivot forward and rearward to resist damage. The hinge has three detent positions: forward, rearward, and normal.

**Power Remote Control Mirrors**

The power MIRROR switch is located on driver's door trim panel.

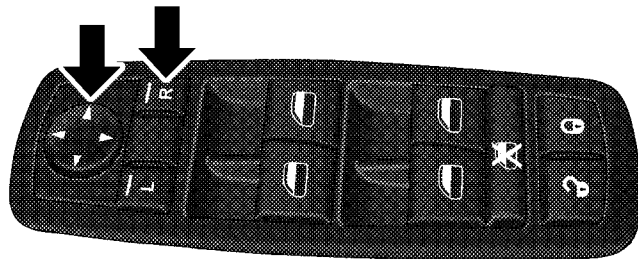

81d10e01

**Power MIRROR Switches*****Models without Express Window Feature***

Press the mirror SELECT button marked L or R and then press one of the four arrow buttons to move the mirror in the direction the arrow is pointing.



**Models with Express Window Feature**

Press and release the mirror SELECT button marked L or R and then press one of the four arrow buttons to move the mirror in the direction the arrow is pointing. The selection times out after 30 seconds of inactivity in order to guard against accidentally changing a mirror position following an adjustment.

**Heated Remote Control Mirrors — If Equipped**

These mirrors are heated to melt frost or ice. This feature is activated whenever you turn on the Electric Rear Window Defroster.

**Illuminated Vanity Mirrors — If Equipped**

An illuminated vanity mirror is on each sun visor. To use the mirror, rotate the sun visor downward and swing the mirror cover upward. The light will turn on automatically. Closing the mirror cover will turn off the light.

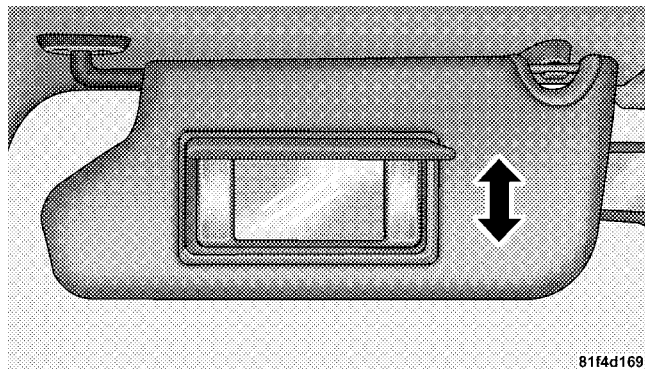

**Illuminated Vanity Mirror**

**Sun Visor “Slide-On Rod” Feature — If Equipped**

This feature allows for additional flexibility in positioning the visor to block out the sun.

1. Fold down the sun visor.
2. Unclip the visor from the center clip.

3. Pull the sun visor toward the inside rearview mirror to extend it.

### **PARKVIEW® REAR BACKUP CAMERA — IF EQUIPPED**

The Parkview® Rear Backup Camera captures live video of the area behind the vehicle. The live video displays on the radio's display screen when backing up your vehicle.

**NOTE:** Refer to “Setting Display Properties,” under “System Settings” in the Navigation User's Manual for navigation screen brightness adjustment instructions.

To operate the Rear Backup Camera:

1. Start the engine.
2. Move the shift lever into REVERSE.
3. Wait one to two seconds and the video will display on the radio's display screen.

**NOTE:** The video will only display while the shift lever is in REVERSE.

### **WARNING!**

**Drivers must be careful when backing up a vehicle, even when using the Rear Backup Camera. Always check carefully for pedestrians, animals, other vehicles, obstructions, and blind spots before backing up a vehicle. You are responsible for the safety of your surroundings and must continue to pay attention while backing up a vehicle. Failure to do so can result in serious injury or death.**

**CAUTION!**

- To avoid vehicle damage, only use the Rear Backup Camera as a parking aid, as the camera is unable to capture every obstacle or object in your drive path.
- To avoid vehicle damage, drive slowly when backing up a vehicle so that you can stop in time when an obstacle comes into view. It is recommended that the driver look frequently over their shoulder when backing up a vehicle.

**NOTE:** If snow, ice, mud, or anything else builds up on the camera lens, clean the lens, rinse with water, and dry with a soft cloth. Do not cover the lens.

**HANDS-FREE COMMUNICATION (UConnect®) — IF EQUIPPED**

**NOTE:** The sales code RER, REN and REU radios contain an integrated Hands-Free Communication (UConnect®) system. Refer to your “Navigation User’s Manual” for UConnect® system operating instructions for these radios.

UConnect® is a voice-activated, hands-free, in-vehicle communications system. UConnect® allows you to dial a phone number with your cellular phone using simple voice commands (e.g., “Call” ... “Mike” ... “Work” or “Dial” ... “248-555-1212”). Your cellular phone’s audio is transmitted through your vehicle’s audio system; the system will automatically mute your radio when using the UConnect® system.

**NOTE:** The UConnect® system requires a cellular phone equipped with the Bluetooth® "Hands-Free Profile," Version 0.96 or higher. See the UConnect® website for supported phones.

**NOTE:** For UConnect® customer support, visit the following websites:

- [www.chrysler.com/uconnect](http://www.chrysler.com/uconnect)
- [www.dodge.com/uconnect](http://www.dodge.com/uconnect)
- [www.jeep.com/uconnect](http://www.jeep.com/uconnect)
- or call 1-877-855-8400

UConnect® allows you to transfer calls between the system and your cellular phone as you enter or exit your vehicle and enables you to mute the system's microphone for private conversation.

The UConnect® phonebook enables you to store up to 32 names, with four numbers per name. Each language has

a separate 32-name phonebook accessible only in that language. This system is driven through your Bluetooth® "Hands-Free profile" cellular phone. UConnect® features Bluetooth® technology - the global standard that enables different electronic devices to connect to each other without wires or a docking station, so UConnect® works no matter where you stow your cellular phone (be it your purse, pocket, or briefcase), as long as your phone is turned on and has been paired to the vehicle's UConnect® system. The UConnect® system allows up to seven cellular phones to be linked to the system. Only one linked (or paired) cellular phone can be used with the system at a time. The system is available in English, Spanish, or French languages.

### ***Phone Button***



The rearview mirror contains the microphone for the system (depending on the type of mirror and radio equipped), and either the

radio or the mirror has the two control buttons (PHONE Button and VOICE RECOGNITION button) that will enable you to access the system.

### **Voice Recognition Button**



Actual button location may vary with radio. The individual buttons are described in the “Operation” section.

The UConnect® system can be used with any Hands-Free Profile certified Bluetooth® cellular phone. See the UConnect® website for supported phones. If your cellular phone supports a different profile (e.g., Headset Profile) you may not be able to use any UConnect® features. Refer to your cellular service provider or the phone manufacturer for details.

The UConnect® system is fully integrated with the vehicle’s audio system. The volume of the UConnect® system

can be adjusted either from the radio volume control knob or from the steering wheel radio control (right switch), if so equipped.

The radio display will be used for visual prompts from the UConnect® system such as “CELL” or caller ID on certain radios.

### **Operation**

Voice commands can be used to operate the UConnect® system and to navigate through the UConnect® menu structure. Voice commands are required after most UConnect® system prompts. You will be prompted for a specific command and then guided through the available options.

- Prior to giving a voice command, one must wait for the beep, which follows the “Ready” prompt or another prompt.

- For certain operations, compound commands can be used. For example, instead of saying "Setup" and then "Phone Pairing," the following compound command can be said: "Setup Phone Pairing."
- For each feature explanation in this section, only the combined form of the voice command is given. You can also break the commands into parts and say each part of the command when you are asked for it. For example, you can use the combined form voice command "Phonebook New Entry," or you can break the combined form command into two voice commands: "Phonebook" and "New Entry." Please remember, the UConnect® system works best when you talk in a normal conversational tone, as if speaking to someone sitting a few feet/meters away from you.

### **Voice Command Tree**

Refer to "Voice Tree" in this section.

### **Help Command**

If you need assistance at any prompt, or if you want to know your options at any prompt, say "Help" following the beep. The UConnect® system will play all the options at any prompt if you ask for help.

To activate the UConnect® system from idle, simply press the PHONE button and follow the audible prompts for directions. All UConnect® system sessions begin with a press of the PHONE button on the radio control head.

### **Cancel Command**

At any prompt, after the beep, you can say "Cancel" and you will be returned to the main menu. However, in a few instances the system will take you back to the previous menu.

### **Pair (Link) UConnect® System to a Cellular Phone**

To begin using your UConnect® system, you must pair your compatible Bluetooth® enabled cellular phone.

To complete the pairing process, you will need to reference your cellular phone Owner's Manual. The UConnect® website may also provide detailed instructions for pairing.

The following are general phone to UConnect® system pairing instructions:

- Press the PHONE button to begin.
- After the "Ready" prompt and the following beep, say "Setup Phone Pairing."
- When prompted, after the beep, say "Pair a Phone" and follow the audible prompts.
- You will be asked to say a four-digit Personal Identification Number (PIN), which you will later need to enter into your cellular phone. You can enter any four-digit PIN. You will not need to remember this PIN after the initial pairing process.

- For identification purposes, you will be prompted to give the UConnect® system a name for your cellular phone. Each cellular phone that is paired should be given a unique phone name.
- You will then be asked to give your cellular phone a priority level between 1 and 7, with 1 being the highest priority. You can pair up to seven cellular phones to your UConnect® system. However, at any given time, only one cellular phone can be in use, connected to your UConnect® system. The priority allows the UConnect® system to know which cellular phone to use if multiple cellular phones are in the vehicle at the same time. For example, if priority 3 and priority 5 phones are present in the vehicle, the UConnect® system will use the priority 3 cellular phone when you make a call. You can select to use a lower priority cellular phone at any time (refer to "Advanced Phone Connectivity" in this section).

### Dial by Saying a Number

- Press the PHONE button to begin.
- After the "Ready" prompt and the following beep, say "Dial."
- The system will prompt you to say the number you want to call.
- For example, you can say "234-567-8901." The phone number that you enter must be of valid length and combination. Based on the country in which the vehicle was purchased, the UConnect® system limits the user from dialing an invalid combination of numbers. For example, in the U.S., 234-567-890 is nine digits long, which is not a valid U.S. phone number - the closest valid phone number has 10 digits.
- The UConnect® system will confirm the phone number and then dial. The number will appear in the display of certain radios.

### Call by Saying a Name

- Press the PHONE button to begin.
- After the "Ready" prompt and the following beep, say "Call."
- The system will prompt you to say the name of the person you want to call.
- After the "Ready" prompt and the following beep, say the name of the person you want to call. For example, you can say "John Doe," where John Doe is a previously stored name entry in the UConnect® phonebook. To learn how to store a name in the phonebook, refer to "Add Names to Your UConnect® Phonebook," in this section.
- The UConnect® system will confirm the name and then dial the corresponding phone number, which may appear in the display of certain radios.



## Add Names to Your UConnect® Phonebook

**NOTE:** Adding names to the phonebook is recommended when the vehicle is not in motion.

- Press the PHONE button to begin.
- After the "Ready" prompt and the following beep, say "Phonebook New Entry."
- When prompted, say the name of the new entry. Use of long names helps the voice recognition and it is recommended. For example, say "Robert Smith" or "Robert" instead of "Bob."
- When prompted, enter the number designation (e.g., "Home," "Work," "Mobile," or "Pager"). This will allow you to store multiple numbers for each phonebook entry, if desired.
- When prompted, recite the phone number for the phonebook entry that you are adding.

After you are finished adding an entry into the phonebook, you will be given the opportunity to add more phone numbers to the current entry or to return to the main menu.

The UConnect® system will allow you to enter up to 32 names in the phonebook with each name having up to four associated phone numbers and designations. Each language has a separate 32-name phonebook accessible only in that language.

## Phonebook Download

UConnect® allows the user to download entries from their phone via Bluetooth®. To use this feature, press the PHONE button and say "Phonebook Download." The system prompts, "Ready to accept "V" card entry via Bluetooth®..." The system is now ready to accept phonebook entries from your phone using the Bluetooth®

Object Exchange Profile (OBEX). Please see your phone Owner's Manual for specific instructions on how to send these entries from your phone.

**NOTE:**

- The phone handset must support Bluetooth® OBEX transfers of phonebook entries to use this feature.
- Some phones cannot send phonebook entries if they are already connected to any system via Bluetooth®, and you may see a message on the phone display that the Bluetooth® link is busy. In this case, the user must first disconnect or drop the Bluetooth® connection to the UConnect® system, and then send the address book entry via Bluetooth®. Please see your phone Owner's Manual for specific instructions on how to drop the Bluetooth® connection.
- If the phonebook entry is longer than 24 characters, it will only use the first 24 characters.

**Edit Entries in the UConnect® Phonebook**

**NOTE:** Editing names in the phonebook is recommended when the vehicle is not in motion.

- Press the PHONE button to begin.
- After the "Ready" prompt and the following beep, say "Phonebook Edit."
- You will then be asked for the name of the phonebook entry that you wish to edit.
- Next, choose the number designation (home, work, mobile, or pager) that you wish to edit.
- When prompted, recite the new phone number for the phonebook entry that you are editing.

After you are finished editing an entry in the phonebook, you will be given the opportunity to edit another entry in the phonebook, call the number you just edited, or return to the main menu.

"Phonebook Edit" can be used to add another phone number to a name entry that already exists in the phonebook. For example, the entry John Doe may have a mobile and a home number, but you can add "John Doe's" work number later using the "Phonebook Edit" feature.

### Delete Entries in the UConnect® Phonebook

**NOTE:** Editing phonebook entries is recommended when the vehicle is not in motion.

- Press the PHONE button to begin.
- After the "Ready" prompt and the following beep, say "Phonebook Delete."
- After you enter the Phonebook Delete menu, you will then be asked for the name of the entry that you wish to delete. You can either say the name of a phonebook entry that you wish to delete or you can say "List Names" to hear a list of the entries in the phonebook

from which you choose. To select one of the entries from the list, press the "Voice Recognition" button while the UConnect® system is playing the desired entry and say "Delete."

- After you enter the name, the UConnect® system will ask you which designation you wish to delete: home, work, mobile, pager, or all. Say the designation you wish to delete.
- Note that only the phonebook entry in the current language is deleted.

### Delete All Entries in the UConnect® Phonebook

- Press the PHONE button to begin.
- After the "Ready" prompt and the following beep, say "Phonebook Erase All."
- The UConnect® system will ask you to verify that you wish to delete all the entries from the phonebook.

- After confirmation, the phonebook entries will be deleted.
- Note that only the phonebook in the current language is deleted.

### **List All Names in the UConnect® Phonebook**

- Press the PHONE button to begin.
- After the "Ready" prompt and the following beep, say "Phonebook List Names."
- The UConnect® system will play the names of all the phonebook entries.
- To call one of the names in the list, press the "Voice Recognition" button during the playing of the desired name, and say "Call."

**NOTE:** The user can also exercise "Edit" or "Delete" operations at this point.

- The UConnect® system will then prompt you as to the number designation you wish to call.
- The selected number will be dialed.

### **Phone Call Features**

The following features can be accessed through the UConnect® system if the feature(s) are available on your cellular service plan. For example, if your cellular service plan provides three-way calling, this feature can be accessed through the UConnect® system. Check with your cellular service provider for the features that you have.

### **Answer or Reject an Incoming Call - No Call Currently in Progress**

When you receive a call on your cellular phone, the UConnect® system will interrupt the vehicle audio system, if on, and will ask if you would like to answer the call. Press the PHONE button to accept the call. To reject

the call, press and hold the PHONE button until you hear a single beep, indicating that the incoming call was rejected.

### **Answer or Reject an Incoming Call - Call Currently in Progress**

If a call is currently in progress and you have another incoming call, you will hear the same network tones for call waiting that you normally hear when using your cell phone. Press the PHONE button to place the current call on hold and answer the incoming call.

**NOTE:** The UConnect® system compatible phones in the market today do not support rejecting an incoming call when another call is in progress. Therefore, the user can only answer an incoming call or ignore it.

### **Making a Second Call While Current Call in Progress**

To make a second call while you are currently on a call, press the “Voice Recognition” button and say “Dial” or

“Call” followed by the phone number or phonebook entry you wish to call. The first call will be on hold while the second call is in progress. To go back to the first call, refer to “Toggling Between Calls” in this section. To combine two calls, refer to “Conference Call” in this section.

### **Place/Retrieve a Call From Hold**

To put a call on hold, press the PHONE button until you hear a single beep. This indicates that the call is on hold. To bring the call back from hold, press and hold the PHONE button until you hear a single beep.

### **Toggling Between Calls**

If two calls are in progress (one active and one on hold), press the PHONE button until you hear a single beep, indicating that the active and hold status of the two calls have switched. Only one call can be placed on hold at one time.

### **Conference Call**

When two calls are in progress (one active and one on hold), press and hold the PHONE button until you hear a double beep indicating that the two calls have been joined into one conference call.

### **Three-Way Calling**

To initiate three-way calling, press the "Voice Recognition" button while a call is in progress, and make a second phone call, as described under "Making a Second Call While Current Call in Progress." After the second call has established, press and hold the PHONE button until you hear a double beep, indicating that the two calls have been joined into one conference call.

### **Call Termination**

To end a call in progress, momentarily press the PHONE button. Only the active call(s) will be terminated and if there is a call on hold, it will become the new active call. If the active call is terminated by the far end, a call on

hold may not become active automatically. This is cell phone-dependent. To bring the call back from hold, press and hold the PHONE button until you hear a single beep.

### **Redial**

- Press the PHONE button to begin.
- After the "Ready" prompt and the following beep, say "Redial."
- The UConnect® system will call the last number that was dialed from your cellular phone.

**NOTE:** This may not be the last number dialed from the UConnect® system.

### **Call Continuation**

Call continuation is the progression of a phone call on the UConnect® system after the vehicle ignition key has been switched to OFF. Call continuation functionality available on the vehicle can be any one of three types:

- After the ignition key is switched to OFF, a call can continue on the UConnect® system either until the call ends, or until the vehicle battery condition dictates cessation of the call on the UConnect® system and transfer of the call to the mobile phone.
- After the ignition key is switched to OFF, a call can continue on the UConnect® system for a certain duration, after which the call is automatically transferred from the UConnect® system to the mobile phone.
- An active call is automatically transferred to the mobile phone after the ignition key is switched to OFF.

## UConnect® System Features

### Language Selection

To change the language that the UConnect® system is using:

- Press the PHONE button to begin.

- After the "Ready" prompt and the following beep, say the name of the language you wish to switch to English, Espanol, or Francais.
- Continue to follow the system prompts to complete language selection.

After selecting one of the languages, all prompts and voice commands will be in that language.

**NOTE:** After every UConnect® language change operation, only the language-specific 32-name phonebook is usable. The paired phone name is not language-specific and usable across all languages.

### Emergency Assistance

If you are in an emergency and the mobile phone is reachable:

- Pick up the phone and manually dial the emergency number for your area.

If the phone is not reachable and the UConnect® system is operational, you may reach the emergency number as follows:

- Press the PHONE button to begin.
- After the "Ready" prompt and the following beep, say "Emergency" and the UConnect® system will instruct the paired cellular phone to call the emergency number. This feature is supported in the U.S., Canada, and Mexico.

**NOTE:** The emergency number dialed is based on the country where the vehicle is purchased (911 for the U.S. and Canada and 060 for Mexico). The number dialed may not be applicable with the available cellular service and area.

The UConnect® system does slightly lower your chances of successfully making a phone call as to that for the cell phone directly.

Your phone must be turned on and paired to the UConnect® system to allow use of this vehicle feature in emergency situations, when the cell phone has network coverage and stays paired to the UConnect® system.

### **Towing Assistance**

If you need towing assistance:

- Press the PHONE button to begin.
- After the "Ready" prompt and the following beep, say "Towing Assistance."

**NOTE:** The Towing Assistance number dialed is based on the country where the vehicle is purchased (1-800-528-2069 for the U.S., 1-877-213-4525 for Canada, 55-14-3454 for Mexico City and 1-800-712-3040 for outside Mexico City in Mexico).

Please refer to the 24-Hour "Towing Assistance" coverage details in the Warranty Information Booklet and on the 24-Hour Towing Assistance Card.



### **Paging**

To learn how to page, refer to "Working with Automated Systems." Paging works properly except for pagers of certain companies, which time out a little too soon to work properly with the UConnect® system.

### **Voice Mail Calling**

To learn how to access your voice mail, refer to "Working with Automated Systems."

### **Working with Automated Systems**

This method is used in instances where one generally has to press numbers on the cellular phone keypad while navigating through an automated telephone system.

You can use your UConnect® system to access a voice mail system or an automated service, such as a paging service or automated customer service line. Some services require immediate response selection. In some instances, that may be too quick for use of the UConnect® system.

When calling a number with your UConnect® system that normally requires you to enter in a touch-tone sequence on your cellular phone keypad, you can press the "Voice Recognition" button and say the sequence you wish to enter, followed by the word "Send." For example, if required to enter your PIN followed with a pound, (3 7 4 6 #), you can press the "Voice Recognition" button and say, "3 7 4 6 # Send." Saying a number, or sequence of numbers, followed by "Send," is also to be used for navigating through an automated customer service center menu structure, and to leave a number on a pager.

You can also send stored UConnect® phonebook entries as tones for fast and easy access to voice mail and pager entries. To use this feature, dial the number you wish to call and then press the "Voice Recognition" button and say, "Send." The system will prompt you to enter the name or number and say the name of the phonebook entry you wish to send. The UConnect® system will then

send the corresponding phone number associated with the phonebook entry, as tones over the phone.

**NOTE:**

- You may not hear all of the tones due to cellular phone network configurations; this is normal.
- Some paging and voice mail systems have system time out settings that are too short and may not allow the use of this feature.

**Barge In - Overriding Prompts**

The “Voice Recognition” button can be used when you wish to skip part of a prompt and issue your voice recognition command immediately. For example, if a prompt is asking “Would you like to pair a phone, clear a...,” you could press the “Voice Recognition” button and say, “Pair a Phone” to select that option without having to listen to the rest of the voice prompt.

**Turning Confirmation Prompts On/Off**

Turning confirmation prompts off will stop the system from confirming your choices (e.g., the UConnect® system will not repeat a phone number before you dial it).

- Press the PHONE button to begin.
- After the “Ready” prompt and the following beep, say “Setup Confirmations.” The UConnect® system will play the current confirmation prompt status and you will be given the choice to change it.

**Phone and Network Status Indicators**

If available on the radio and/or on a premium display such as the instrument panel cluster, and supported by your cell phone, the UConnect® system will provide notification to inform you of your phone and network status when you are attempting to make a phone call using UConnect®. The status is given for roaming, network signal strength, phone battery strength, etc.

### Dialing Using the Cellular Phone Keypad

You can dial a phone number with your cellular phone keypad and still use the UConnect® system (while dialing via the cell phone keypad, the user must exercise caution and take precautionary safety measures). By dialing a number with your paired Bluetooth® cellular phone, the audio will be played through your vehicle's audio system. The UConnect® system will work the same as if you dial the number using voice recognition.

**NOTE:** Certain brands of mobile phones do not send the dial ring to the UConnect® system to play it on the vehicle audio system, so you will not hear it. Under this situation, after successfully dialing a number the user may feel that the call did not go through even though the call is in progress. Once your call is answered, you will hear the audio.

### Mute/Un-Mute (Mute Off)

When you mute the UConnect® system, you will still be able to hear the conversation coming from the other party, but the other party will not be able to hear you. In order to mute the UConnect® system:

- Press the “Voice Recognition” button.
- Following the beep, say “Mute.”

In order to un-mute the UConnect® system:

- Press the “Voice Recognition” button.
- Following the beep, say “Mute off.”

### Advanced Phone Connectivity

#### Transfer Call to and from Cellular Phone

The UConnect® system allows ongoing calls to be transferred from your cellular phone to the UConnect® system without terminating the call. To transfer an ongoing call

from your UConnect® paired cellular phone to the UConnect® system or vice versa, press the “Voice Recognition” button and say “Transfer Call.”

### **Connect or Disconnect Link Between the UConnect® System and Cellular Phone**

Your cellular phone can be paired with many different electronic devices, but can only be actively “connected” with one electronic device at a time.

If you would like to connect or disconnect the Bluetooth® connection between a UConnect® paired cellular phone and the UConnect® system, follow the instructions described in your cellular phone User’s Manual.

### **List Paired Cellular Phone Names**

- Press the PHONE button to begin.
- After the “Ready” prompt and the following beep, say “Setup Phone Pairing.”
- When prompted, say “List Phones.”
- The UConnect® system will play the phone names of all paired cellular phones in order from the highest to the lowest priority. To “select” or “delete” a paired phone being announced, press the “Voice Recognition” button and say “Select” or “Delete.” Also, see the next two sections for an alternate way to “select” or “delete” a paired phone.

### **Select Another Cellular Phone**

This feature allows you to select and start using another phone paired with the UConnect® system.

- Press the PHONE button to begin.
- After the “Ready” prompt and the following beep, say “Setup Select Phone” and follow the prompts.
- You can also press the “Voice Recognition” button at any time while the list is being played, and then choose the phone that you wish to select.

- The selected phone will be used for the next phone call. If the selected phone is not available, the UConnect® system will return to using the highest priority phone present in or near (approximately within 30 ft [9 m]) the vehicle.

### Delete UConnect® Paired Cellular Phones

- Press the PHONE button to begin.
- After the "Ready" prompt and the following beep, say "Setup Phone Pairing."
- At the next prompt, say "Delete" and follow the prompts.
- You can also press the "Voice Recognition" button at any time while the list is being played, and then choose the phone you wish to delete.

### Things You Should Know About Your UConnect® System

#### UConnect® Tutorial

To hear a brief tutorial of the system features, press the PHONE button and say "UConnect® Tutorial."

#### Voice Training

For users experiencing difficulty with the system recognizing their voice commands or numbers, the UConnect® system Voice Training feature may be used. To enter this training mode, follow one of the two following procedures:

From outside the UConnect® mode (e.g., from radio mode):

- Press and hold the "Voice Recognition" button for five seconds until the session begins, or,
- Press the "Voice Recognition" button and say the "Setup, Voice Training" command.

Repeat the words and phrases when prompted by the UConnect® system. For best results, the Voice Training session should be completed when the vehicle is parked with the engine running, all windows closed, and the blower fan switched OFF.

This procedure may be repeated with a new user. The system will adapt to the last trained voice only.

To restore the Voice Recognition system to factory default settings, enter the Voice Training session via the above procedure and follow the prompts.

### **Voice Recognition (VR)**

- For best performance, adjust the rearview mirror to provide at least ½ in (1 cm) gap between the overhead console (if equipped) and the mirror.
- Always wait for the beep before speaking.

- Speak normally, without pausing, just as you would speak to a person sitting a few feet/meters away from you.
- Make sure that no one other than you is speaking during a voice recognition period.
- Performance is maximized under:
  - low-to-medium blower setting,
  - low-to-medium vehicle speed,
  - low road noise,
  - smooth road surface,
  - fully closed windows,
  - dry weather condition.

- Even though the system is designed for users speaking in North American English, French, and Spanish accents, the system may not always work for some.
- When navigating through an automated system such as voice mail, or when sending a page, at the end of speaking the digit string, make sure to say "Send."
- Storing names in the phonebook when the vehicle is not in motion is recommended.
- It is not recommended to store similar sounding names in the UConnect® phonebook.
- The UConnect® phonebook nametag recognition rate is optimized for the person who stored the name in the phonebook.
- You can say "O" (letter "O") for "0" (zero). "800" must be spoken "eight-zero-zero."
- Even though international dialing for most number combinations is supported, some shortcut dialing number combinations may not be supported.
- In a convertible vehicle, system performance may be compromised with the convertible top down.

### **Far End Audio Performance**

- Audio quality is maximized under:
  - low-to-medium blower setting,
  - low-to-medium vehicle speed,
  - low road noise,
  - smooth road surface,
  - fully closed windows,
  - dry weather conditions, and
  - operation from the driver's seat.
- Performance, such as audio clarity, echo, and loudness to a large degree rely on the phone and network, and not the UConnect® system.

- Echo at the far end can sometimes be reduced by lowering the in-vehicle audio volume.
- In a convertible vehicle, system performance may be compromised with the convertible top down.

### **Bluetooth® Communication Link**

Cellular phones have been found to lose connection to the UConnect® system. When this happens, the connection can generally be re-established by switching the phone off/on. Your cell phone is recommended to remain in Bluetooth® ON mode.

### **Power-Up**

After switching the ignition key from OFF to either ON or ACC position, or after a language change, you must wait at least five seconds prior to using the system.



**Voice Tree**

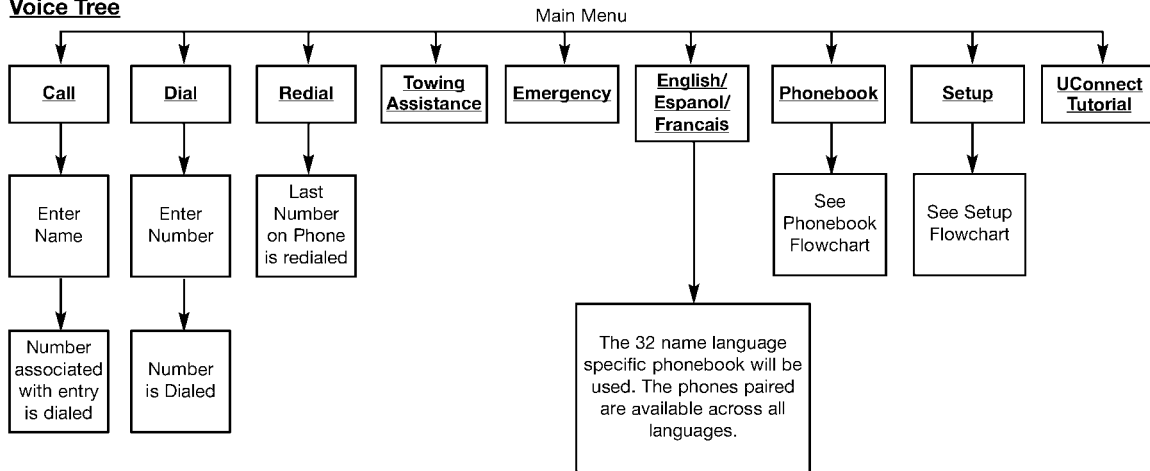

**Note:** Available Voice commands are shown in bold face and are underlined.

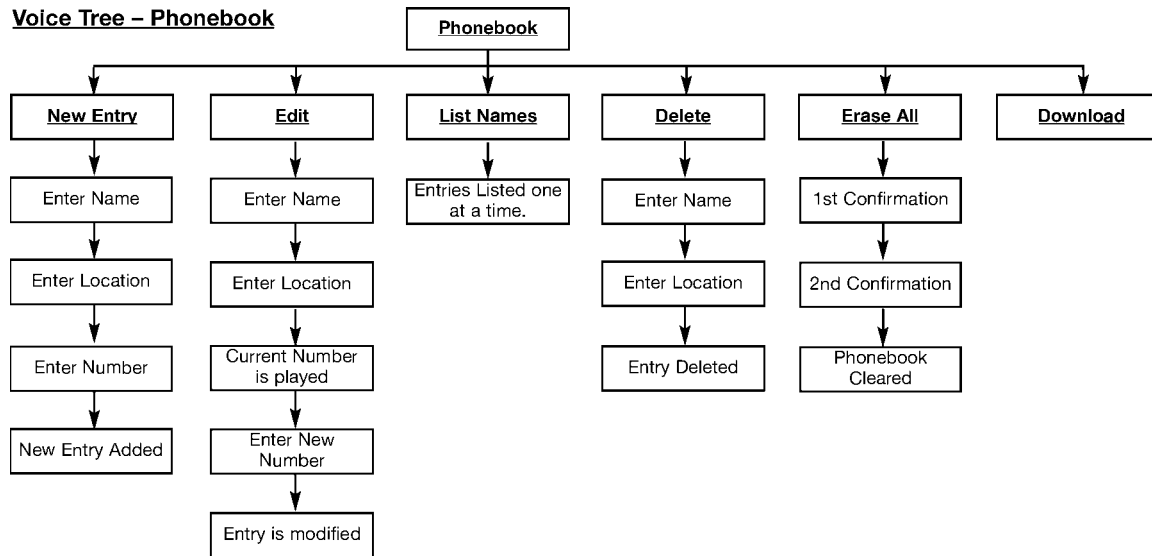
**Voice Tree – Phonebook**

**Note:** Available Voice commands are shown in bold face and are underlined.

**Voice Tree – Setup**

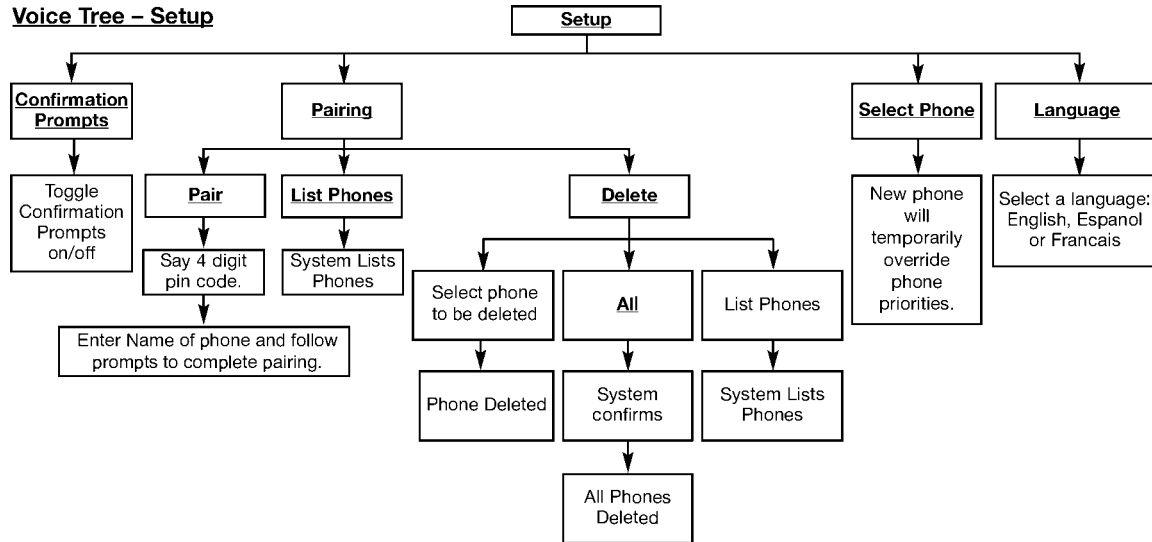

**Note:** Available Voice commands are shown in bold face and are underlined.

819402e4

Voice Commands	
Primary	Alternate(s)
zero	
one	
two	
three	
four	
five	
six	
seven	
eight	
nine	
star (*)	
plus (+)	
pound (#)	
add location	
all	

Voice Commands	
Primary	Alternate(s)
call	
cancel	
confirmation prompts	
continue	
delete	
dial	
download	
edit	
emergency	
English	
erase all	
Espanol	
Francais	
help	
home	

Voice Commands	
Primary	Alternate(s)
language	
list names	
list phones	
mobile	
mute	
mute off	
new entry	
no	
pager	
pair a phone	
phone pairing	pairing
phonebook	phone book
previous	
record again	

Voice Commands	
Primary	Alternate(s)
redial	
return to main menu	return or main menu
select phone	select
send	
set up	phone settings or phone set up
towing assistance	
transfer call	
UConnect® Tutorial	
try again	
voice training	
work	
yes	

### General Information

This device complies with Part 15 of the FCC rules and RSS 210 of Industry Canada. Operation is subject to the following conditions:

- This device may not cause harmful interference.
- This device must accept any interference received, including interference that may cause undesired operation.

### VOICE RECOGNITION SYSTEM — IF EQUIPPED

#### Voice Recognition System (VR) Operation



This Voice Recognition System allows you to control your AM, FM radio, satellite radio, disc player, and a memo recorder.

**NOTE:** In a stressful situation, take care to speak into the Voice Interface System as calmly and normally as possible. The ability of the Voice Interface System to

recognize user voice commands may be negatively affected by rapid speaking or a raised voice level.

### WARNING!

**Any voice commanded system should be used only in safe driving conditions and all attention should be kept on the roadway ahead. Failure to do so may result in an accident causing serious injury or death.**

When you press the VR hard-key, you will hear a beep. The beep is your signal to give a command.

**NOTE:** If you do not say a command within a few seconds, the system will present you with a list of options.

If you ever wish to interrupt the system while it lists options, press the VR hard-key, listen for the beep, and say your command.

Pressing the VR hard-key while the system is speaking is known as “barging in.” The system will be interrupted and you can add or change commands. This will become helpful once you start to learn the options.

**NOTE:** At any time, you can say the words CANCEL, HELP, or MAIN MENU.

These commands are universal and can be used from any menu. All other commands can be used depending upon the active application.

For example, if you are in the disc menu and you are listening to FM radio, you can speak commands from the disc menu or from the FM radio menu.

When using this system, you should speak clearly and at a normal speaking volume.

The system will best recognize your speech if the windows are closed, and the heater/air-conditioning fan is set to low.

At any point, if the system does not recognize one of your commands, you will be prompted to repeat it.

To hear the first available Menu, press the VR hard-key and say HELP or MAIN MENU.

### Commands

The Voice Recognition System understands two types of commands. Global commands are available at all times. Local commands are available if the supported radio mode is active.

### Changing the Volume

1. Start a dialogue by pressing the VR hard-key.
2. Say a command (e.g., HELP).
3. Use the ON/OFF VOLUME rotary knob to adjust the volume to a comfortable level while the voice recognition system is speaking. Please note the volume setting for VR is different than the audio system.

**Main Menu**

Start a dialogue by pressing the VR hard-key. You may say MAIN MENU to switch to the main menu.

In this mode, you can say the following commands:

- RADIO (to switch to the radio mode)
- DISC (to switch to the disc mode)
- MEMO (to switch to the memo recorder)

**Radio AM (or Radio Long Wave or Radio Medium Wave - if equipped)**

To switch to the AM band say AM or RADIO AM. In this mode, you may say the following commands:

- FREQUENCY (to change the frequency)
- NEXT STATION (to select the next station)

- PREVIOUS STATION (to select the previous station)
- RADIO MENU (to switch to the radio menu)
- MAIN MENU (to switch to the main menu)

**Radio FM**

To switch to the FM band say FM or RADIO FM. In this mode, you may say the following commands:

- FREQUENCY (to change the frequency)
- NEXT STATION (to select the next station)
- PREVIOUS STATION (to select the previous station)
- RADIO MENU (to switch to the radio menu)
- MAIN MENU (to switch to the main menu)



### Satellite Radio

To switch to satellite radio mode say SAT or SATELLITE RADIO. In this mode, you may say the following commands:

- CHANNEL NUMBER (to change the channel by its spoken number)
- NEXT CHANNEL (to select the next channel)
- PREVIOUS CHANNEL (to select the previous channel)
- LIST CHANNEL (to hear a list of available channels)
- SELECT NAME (to say the name of a channel)
- RADIO MENU (to switch to the radio menu)
- MAIN MENU (to switch to the main menu)

### Disc

To switch to the disc mode say DISC. In this mode, you may say the following commands:

- TRACK (#) (to change the track)
- NEXT TRACK (to play the next track)
- PREVIOUS TRACK (to play the previous track)
- MAIN MENU (to switch to the main menu)

### Memo

To switch to the voice recorder mode say MEMO. In this mode, you may say the following commands:

- NEW MEMO (to record a new memo) — During the recording you may press the VR hard-key to stop recording. You continue by saying one of the following commands:
  - SAVE (to save the memo)

- CONTINUE (to continue recording)
- DELETE (to delete the recording)
- PLAY MEMOS (to play previously recorded memos)
  - During the playback you may press the VR hard-key to stop playing memos. You continue by saying one of the following commands:
    - REPEAT (to repeat a memo)
    - NEXT (to play the next memo)
    - PREVIOUS (to play the previous memo)
    - DELETE (to delete a memo)
- DELETE ALL (to delete all memos)

**NOTE:** Keep in mind that you have to press the VR hard-key first and wait for the beep, before speaking the “barge in” commands.

### **Voice Training**

For users experiencing difficulty with the system recognizing their voice commands or numbers, the UConnect® system Voice Training feature may be used.

1. Press the VR hard-key, speak “System Setup” and once you are in that menu then speak “Voice Training.” This will train your own voice to the system and will improve recognition.
2. Repeat the words and phrases when prompted by the UConnect® System. For best results, the Voice Training session should be completed when the vehicle is parked, engine running, all windows closed, and the blower fan switched OFF. This procedure may be repeated with a new user. The system will adapt to the last trained voice only.

## SEATS

### Manual Front Seat Adjustments

#### Forward and Rearward Adjustment

The manual seat adjustment bar is at the front of the seat, near the floor. Pull the bar upward to move the seat forward or rearward. Release the bar once the seat is in the position desired. Then, using body pressure, move forward and rearward on the seat to be sure that the seat adjusters have latched.

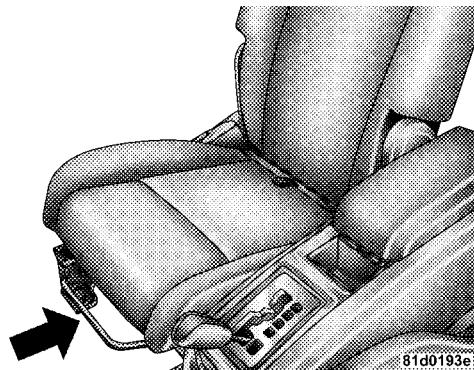

Manual Seat Adjustment

**WARNING!**

Adjusting a seat while the vehicle is moving is dangerous. The sudden movement of the seat could cause you to lose control. The seat belt might not be adjusted properly and you could be injured. Adjust any seat only while the vehicle is parked.

**Recliner Adjustment**

The control lever is on the outboard side of the seat. To recline the seat, lean forward slightly and lift the lever. Then lean back to the position desired and release the lever. To return the seatback to its normal upright position, lean forward and lift the lever. Release the lever once the seatback is in the upright position.

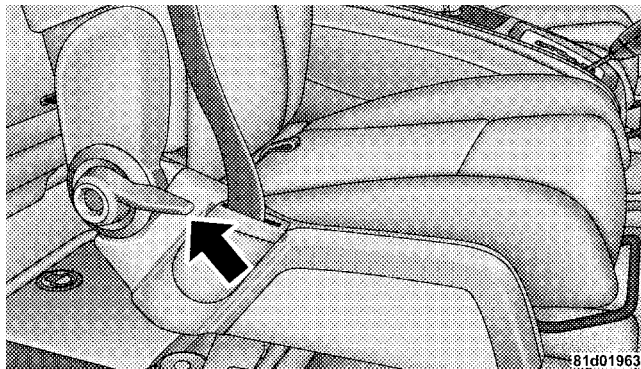
**Seatback Release**

**WARNING!**

- **Adjusting a seat while the vehicle is moving is dangerous. The sudden movement of the seat could cause you to lose control. The seat belt might not be adjusted properly and you could be injured. Adjust the seat only while the vehicle is parked.**
- **Do not ride with the seatback reclined so that the shoulder belt is no longer resting against your chest. In a collision you could slide under the seat belt and be seriously or even fatally injured. Use the recliner only when the vehicle is parked.**

**Lumbar Support — If Equipped**

The control lever is on the outboard side of the seatback. Turn the control lever downward to increase the lumbar support or upward to decrease the lumbar support as desired.

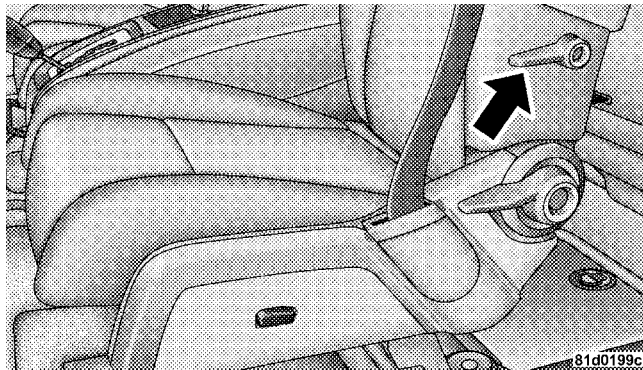
**Lumbar Control**

**Driver's Seat Height Adjustment — If Equipped**

The control lever is located on the outboard side of the seat. Raise the lever to raise the seat. Lower the lever to lower the seat. The total seat travel is 2.15 in (55 mm).

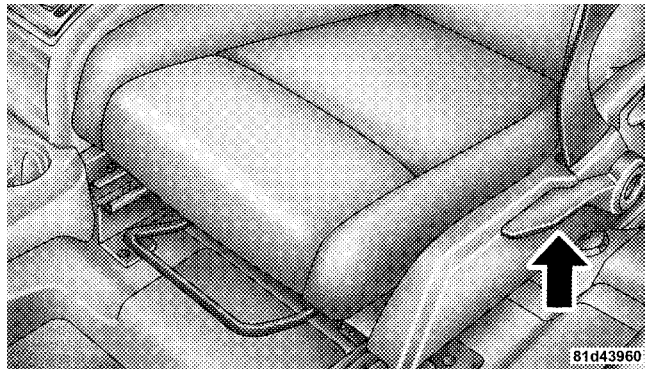

**Seat Height Adjustment Lever**

**Fold Flat Front Passenger Seat — If Equipped**

This feature allows for extended cargo space. When the seat is folded flat, it is an extension of the load floor surface (allowing long cargo to fit from the rear hatch up to the instrument panel). The fold-flat seatback also has a hard-back surface that you can use as a work surface when the seat is folded flat and the vehicle is not in motion.

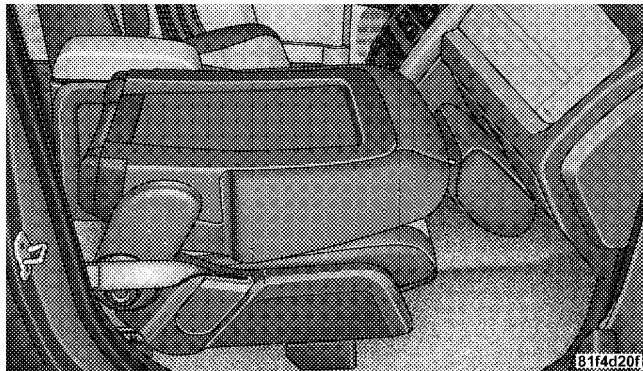

**Fold Flat Seat**

Pull upward on the lever to fold or unfold the seat.

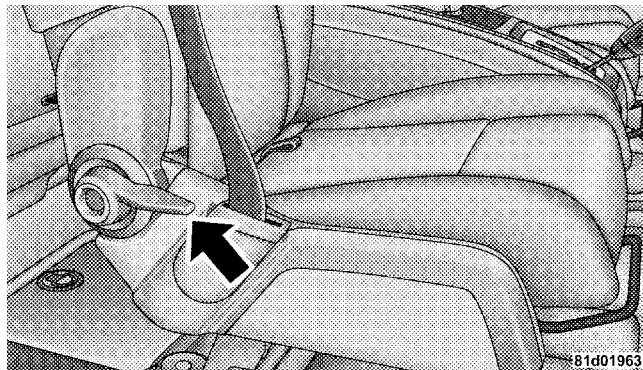

**Seatback Release**

### **WARNING!**

Adjusting a seat while the vehicle is moving is dangerous. The sudden movement of the seat could cause you to lose control. Adjust any seat only while the vehicle is parked.

**Power Seat — If Equipped**

The power seat switch is on the outboard side of the seat near the floor. Use this switch to move the seat up, down, forward, rearward, or to tilt the seat.

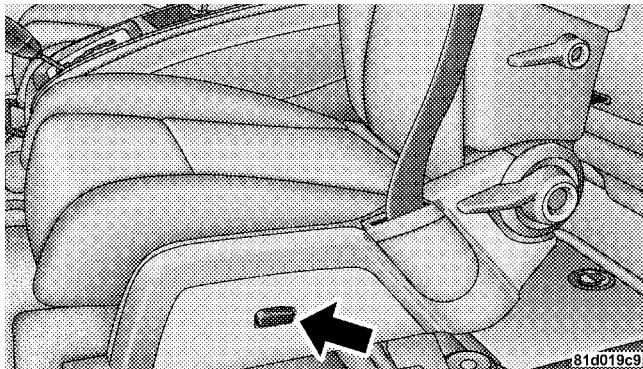

**Power Seat Switch**

**CAUTION!**

**Do not place any article under any seat as it may cause damage to the seat controls.**

**WARNING!**

**Adjusting a seat while the vehicle is moving is dangerous. The sudden movement of the seat could cause you to lose control. The seat belt might not be adjusted properly and you could be injured. Adjust any seat only while the vehicle is parked.**



## Head Restraints

Head restraints can reduce the risk of whiplash injury in the event of impact from the rear.

## Front Seats

Adjust the head restraints so that the upper edge is as high as practical. The left sleeve that the head restraint post slides through contains a lock release button. You can raise the head restraint without pressing this button. However, you must press this button to lower the head restraint.

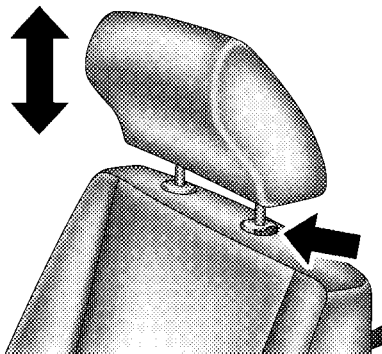

81d019d0

### Adjustable Head Restraint

To remove the head restraint, you must press the lock release button on the left sleeve and the right sleeve simultaneously. To reinstall the head restraint, insert the posts into the sleeves and push the head restraint downward until it locks in place. Then, if desired, press the button on the left sleeve and lower the head restraint.

**WARNING!**

- **Do not sit in a seat or allow a passenger to sit in a seat without having the head restraint installed and adjusted properly. Failure to follow this warning may result in personal injury to you or your passenger in the event of an accident.**
- **Do not leave a head restraint that is removed from a seat loose in the vehicle. A loose head restraint thrown forward in a collision or hard stop could endanger the occupants of the vehicle.**

**Second Row Passenger Seats**

These head restraints are non-adjustable and non-removable.

**Third Row Passenger Seats — Seven Passenger Models**

These head restraints are non-adjustable and non-removable. However, you can fold them forward when they are not in use by passengers. Refer to “50/50 Split Third-Row Passenger Seats with Fold-Flat Feature” for operating instructions.

**WARNING!**

**Do not allow a passenger to sit in a third row seat without having the head restraint unfolded and locked in place. Failure to follow this warning may result in personal injury to the passenger in the event of an accident.**

### Heated Seats — If Equipped

Heated seats provide comfort and warmth on cold days and can help soothe sore muscles and backs. The heaters provide the same heat level for both cushion and back. The driver's seat and front passenger's seat are heated.

The controls for each heater are located in the switch bank in the center of the instrument panel. After turning ON the ignition, you can choose from High, Low, or Off heat settings. Amber indicator lights in each switch indicate the level of heat in use. Two indicator lights will illuminate for high, one for low, and none for off.

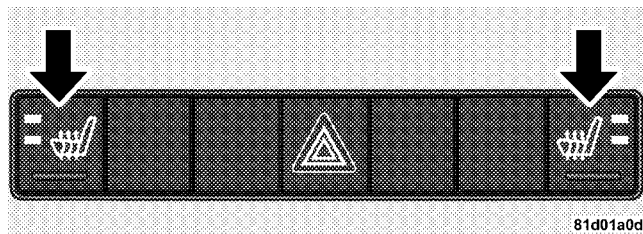

#### Heated Seat Switch

Press the switch once to select high-level heating. Press the switch a second time to select low-level heating. Press the switch a third time to shut OFF the heating elements.

If high level heating is selected, the system automatically switches to low level heating and turns one indicator light off after 30 minutes of continuous operation. It will turn the heater and the remaining indicator light off after an additional 30 minutes of continuous operation. If low

level heating is selected, the system automatically turns the heater and the indicator light off after 30 minutes of continuous operation.

**NOTE:** Once a heat setting is selected, heat will be felt within two to five minutes.

### **WARNING!**

**Persons who are unable to feel pain to the skin because of advanced age, chronic illness, diabetes, spinal cord injury, medication, alcohol use, exhaustion or other physical condition must exercise care when using the seat heater. It may cause burns even at low temperatures, especially if used for long periods. Do not place anything on the seat that insulates against heat, such as a blanket or cushion. This may cause the seat heater to overheat.**

### **60/40 Split Second-Row Passenger Seats**

To provide additional storage area, each second-row passenger seat can be folded flat. This allows for extended cargo space and still maintains some seating room if needed.

**NOTE:** Prior to folding the second-row passenger seat, make sure the front seatback is not in a reclined position. This will allow the seat to fold easily.

**WARNING!**

- It is extremely dangerous to ride in a cargo area, inside or outside of a vehicle. In a collision, people riding in these areas are more likely to be seriously injured or killed.
- Do not allow people to ride in any area of your vehicle that is not equipped with seats and seat belts.
- Be sure everyone in your vehicle is in a seat and using a seat belt properly.
- On seven passenger models, do not allow a passenger to sit in a third row seat with the second row seatback(s) folded flat. In a collision, the passenger could slide underneath the seat belt and be seriously or even fatally injured.

**To Fold the Seat**

1. Locate the control lever on the lower outboard side of the seat.

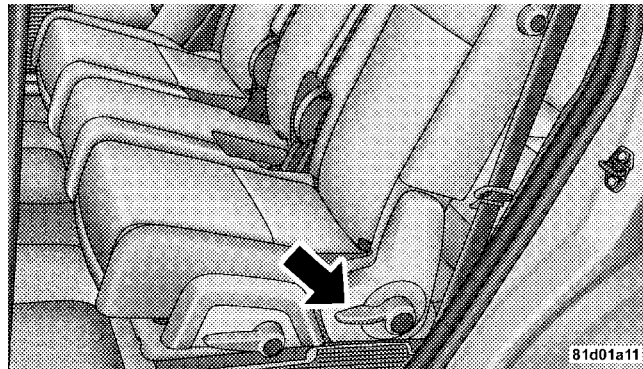
**Seatback Release**

2. Place one hand on the seatback and apply a gentle pressure.

3. Lift the control lever with the other hand, allow the seatback to move forward slightly, and then release the lever.

**WARNING!**

**To prevent personal injury or damage to objects, keep your head, arms, and objects out of the folding path of the seatback.**

4. Gently guide the seatback into the folded position.

**To Unfold the Seat**

Raise the seatback and lock it in place.

**WARNING!**

**Be certain that the seatback is locked securely into position. Otherwise, the seat will not provide the proper stability for child seats and/or passengers. An improperly latched seat could cause serious injury.**

**Forward and Rearward Adjustment**

The control lever is on the outboard side of the seat. Lift the lever to move the seat forward or rearward. Release the lever once the seat is in the position desired. Then, using body pressure, move forward and rearward on the seat to be sure that the seat adjusters have latched.

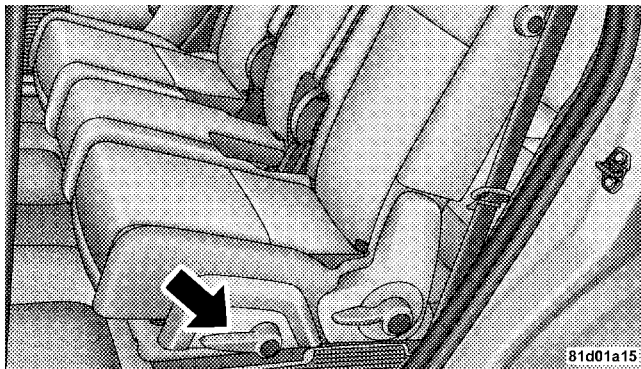

**Manual Seat Adjustment**

### **WARNING!**

Adjusting a seat while the vehicle is moving is dangerous. The sudden movement of the seat could cause you to lose control. The seat belt might not be adjusted properly and you could be injured. Adjust any seat only while the vehicle is parked.

## Recliner Adjustment

The control lever is on the outboard side of the seat. To recline the seat, lean back, lift the lever, position the seatback as desired, and then release the lever. To return the seatback to its normal upright position, lean back, lift the lever, lean forward, and then release the lever once the seatback is in the upright position.

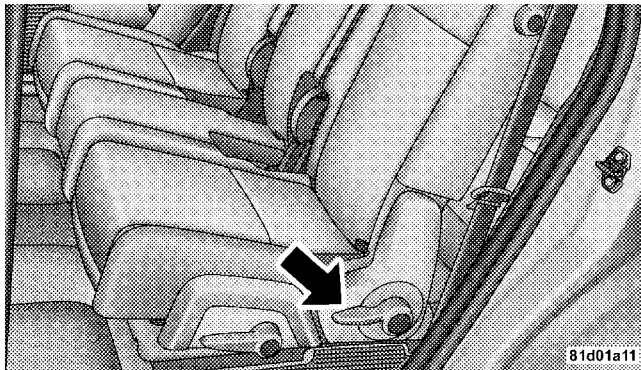

Seatback Release

## WARNING!

- **Adjusting a seat while the vehicle is moving is dangerous. The sudden movement of the seat could cause you to lose control. The seat belt might not be adjusted properly and you could be injured. Adjust the seat only while the vehicle is parked.**
- **Do not ride with the seatback reclined so that the shoulder belt is no longer resting against your chest. In a collision you could slide under the seat belt and be seriously or even fatally injured. Use the recliner only when the vehicle is parked.**



### 20% Seatback/Armrest — Second Row Passenger Seat

The latch release-loop is located at the top of the 20% seatback/armrest. Pull the release-loop upward to release the latch and then downward to lower the 20% seatback/armrest.

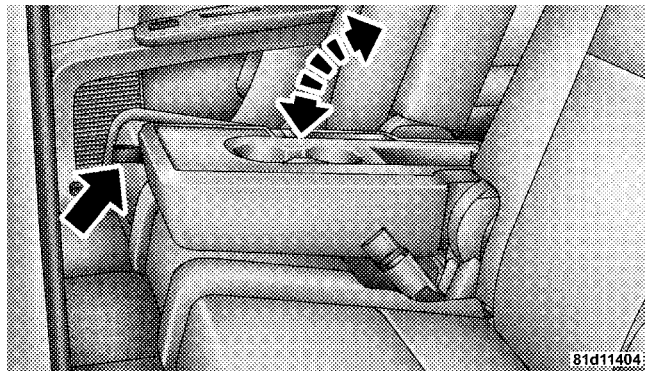

Latch Release-Loop

Raise the 20% seatback/armrest and lock it in place when not in use or when additional seating area is required.

#### **WARNING!**

Keep the latch clean and free of objects and be certain that the seatback is locked securely into position. Otherwise, the seat will not provide the proper stability for child seats and/or passengers. An improperly latched seat could cause serious injury.

**Integrated Child Booster Seat — If Equipped**

The Integrated Child Booster Seat is located in each outboard second-row passenger seat. The Booster Seat is designed for children weighing between 48 and 85 lbs (22 and 39 kg) and 57 in (145 cm) tall or less.

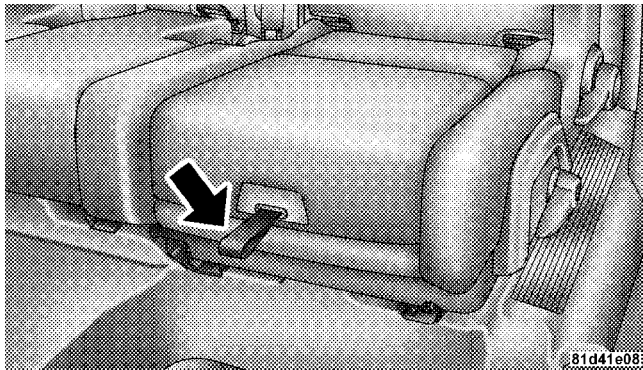

**Integrated Child Booster Seat**

The booster seat latch release-loop is located at the front of the seat cushion. Pull the release-loop forward to release the latch and seat cushion. Then, lift seat cushion up and push back to lock it in the booster seat position. When not using the booster seat, pull the release-loop forward to release the latch and seat cushion. Then, pull the seat cushion forward. Finally, push downward on the rear of the seat cushion to lock it in the normal position.

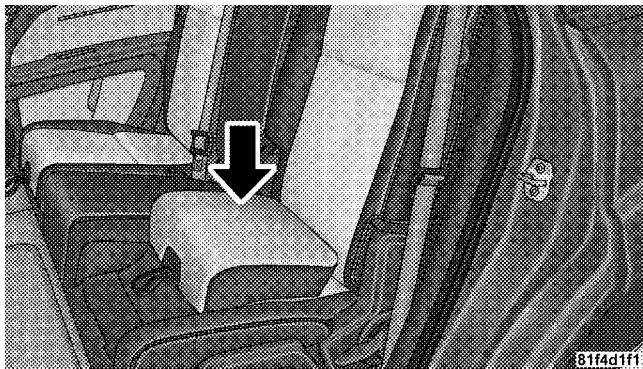

**Integrated Child Booster Seat**

### **WARNING!**

Be certain that the seat cushion is locked securely into position before using the seat. Otherwise, the seat will not provide the proper stability for child seats and/or passengers. An improperly latched seat cushion could cause serious injury.

3

### **Stadium Tip 'n Slide™ (Easy Entry/Exit Seat) — Seven Passenger Models**

This feature allows passengers to easily enter or exit the third-row passenger seats from either side of the vehicle.

#### ***To Move the Second-Row Passenger Seat Forward***

**NOTE:** Raise the 20% seatback/armrest before moving the 60% seat to allow for full seat travel.

Move the control lever on the upper outboard side of the seatback forward, and in one fluid motion, the seat cushion flips upward and the seat moves forward on its tracks.

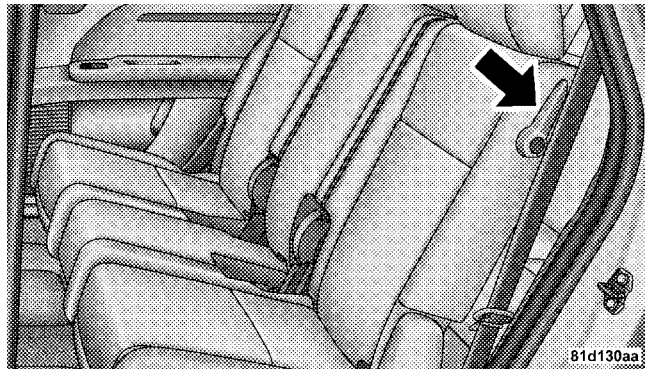

**Tip 'n Slide™ Control Lever**

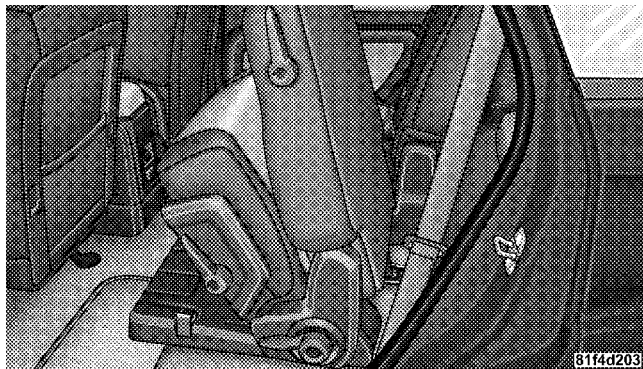

**Tip n Slide Seat™**

**NOTE:** A hand-grip is molded into the front of each quarter trim panel near the door opening to assist entry and exit from the third-row passenger seats.

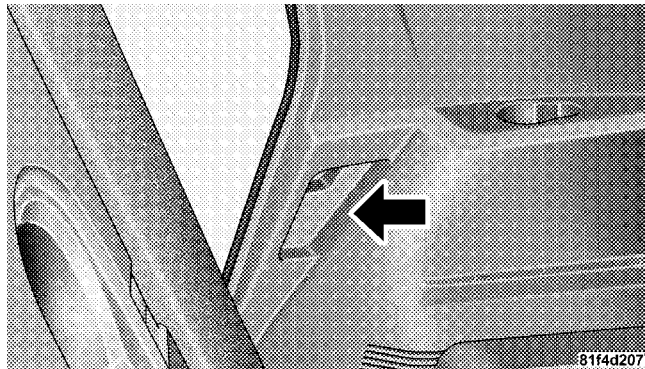

**Grab Handle**

### **WARNING!**

**Do not drive the vehicle with the seat in this position, as it is only intended for entering and exiting the third row seats. Failure to follow this warning may result in personal injury.**

**3**

#### *To Unfold and Move the Second-Row Passenger Seat Rearward*

1. Move the seatback rearward until it locks in place and then continue sliding the seat rearward on its tracks until it locks in place.
2. Push the seat cushion downward to lock it in place.
3. Adjust the seat track position as desired. Then, using body pressure, move forward and rearward on the seat to be sure that the seat adjusters have latched.

**WARNING!**

Be certain that the seatback and seat are locked securely into position. Otherwise, the seat will not provide the proper stability for child seats and/or passengers. An improperly latched seat could cause serious injury.

**50/50 Split Third-Row Passenger Seats with Fold-Flat Feature — Seven Passenger Models**

To provide additional storage area, each third-row passenger seat can be folded flat. This allows for extended cargo space and still maintains some rear seating room if needed.

**NOTE:** Prior to folding the third-row passenger seat, make sure the second-row passenger seat is not in a reclined position. This will allow the seat to fold easily.

**To Fold the Seat**

Pull the latch release-loop located at the top of the seatback upward, push the seat forward slightly, and release the release-loop. Then, continue to push the seat forward. The head restraints will fold automatically as the seat moves forward.

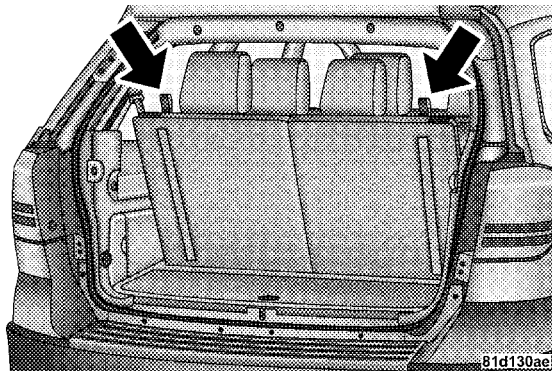

**Seatback Release**

### To Unfold the Seat

Grasp the assist strap loop on the seatback and pull it toward you to raise the seatback. Continue to raise the seatback until it locks in place. Then, raise the head restraint to lock it in place.

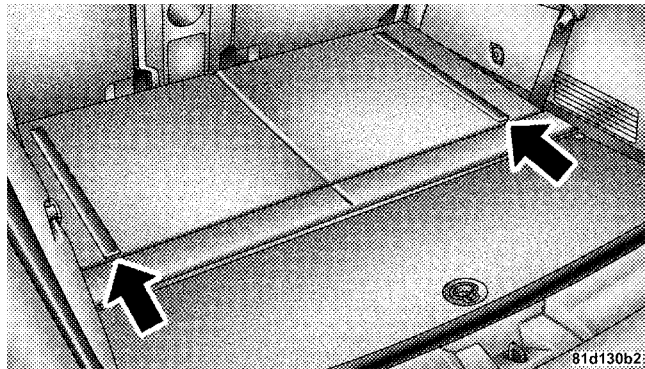

Assist Strap

The seatback can also be locked in a reclined position. To do so, pull the latch release-loop located at the top of the seatback upward, allow the seatback to recline, and release the release-loop.

### WARNING!

- Be certain that the seatback is locked securely into position. Otherwise, the seat will not provide the proper stability for passengers. An improperly latched seat could cause serious injury.
- Do not allow a passenger to sit in a third row seat without having the head restraint unfolded and locked in place. Failure to follow this warning may result in personal injury to the passenger in the event of an accident.
- Do not allow a passenger to sit in a third row seat with the second row seatback(s) folded flat. In a collision, the passenger could slide underneath the seat belt and be seriously or even fatally injured.

**TO OPEN AND CLOSE THE HOOD**

Two latches must be released to open the hood. First, pull the hood release lever located under the left side of the instrument panel.

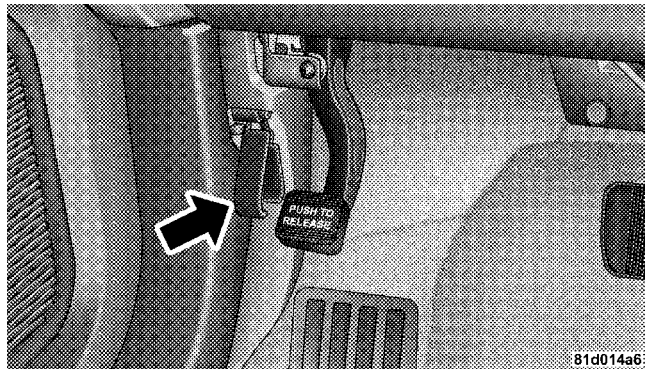
**Hood Release**

Outside of the vehicle, locate the safety latch lever near the center of the grille between the grille and hood opening. Push the safety latch lever to the right and then raise the hood.

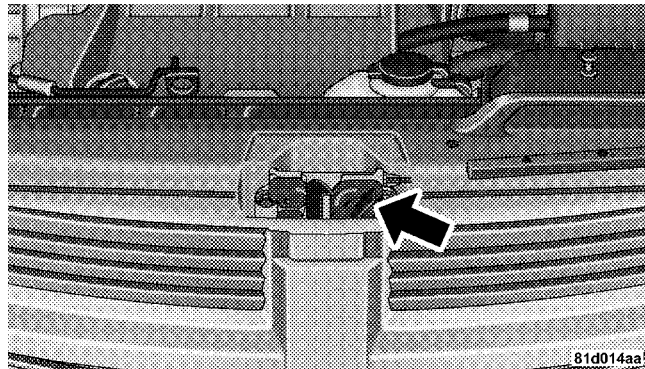
**Underhood Safety Latch**



Use the hood prop rod to secure the hood in the open position. Place the upper end of the prop rod in the hole on the underside of the hood.

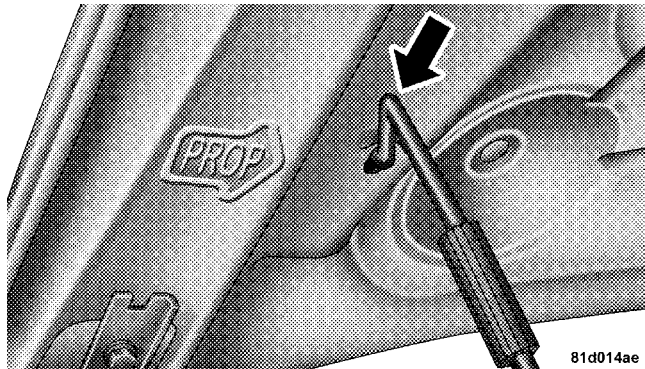

Hood Prop Rod

81d014ae

To prevent possible damage:

- Before closing hood, make sure the hood prop rod is fully seated into its storage retaining clips.
- Do not slam the hood to close it. Use a firm downward push at the center front edge of the hood to ensure that both latches engage. Never drive your vehicle unless the hood is fully closed, with both latches engaged.

### WARNING!

If the hood is not fully latched, it could fly up when the vehicle is moving and block your forward vision. Be sure all hood latches are fully latched before driving. Failure to follow this warning may lead to an accident resulting in serious injury or death.

## LIGHTS

### Exterior and Interior Lighting Control



The multifunction lever on the left side of the steering column controls the operation of the headlights, parking lights, turn signal lights, instrument panel lights, instrument panel light dimming, interior lights, and fog lights (if equipped).

### Headlights and Parking Lights

Turn the end of the multifunction lever to the first detent for parking light operation. Turn the end of the lever to the second detent for headlight operation.

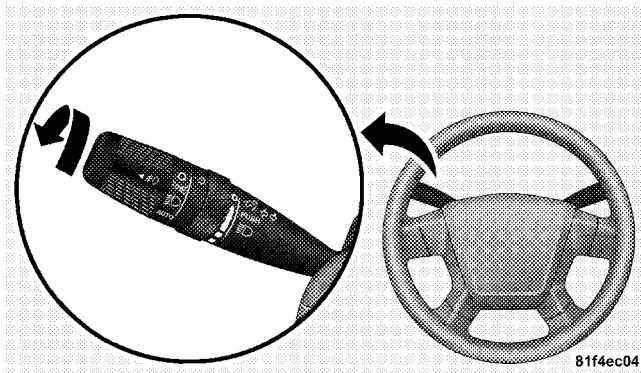

Headlight Switch

### **Automatic Headlights — If Equipped**

This system automatically turns the headlights on or off according to ambient light levels. To turn the system ON, turn the end of the multifunction lever to the AUTO position (third detent). When the system is on, the headlight time delay feature is also on. This means the headlights will stay on for up to 90 seconds after you turn the ignition switch to the LOCK position. To turn the Automatic System OFF, turn the end of the multifunction lever out of the AUTO position.

**NOTE:** The engine must be running before the headlights will turn on in the automatic mode.

### **Headlights with Wipers (Available with Auto Headlights Only)**

When this feature is active, the headlights will turn on approximately 10 seconds after the wipers are turned ON if the multifunction lever is placed in the AUTO position.

In addition, the headlights will turn off when the wipers are turned OFF if they were turned ON by this feature.

The Headlights with Wipers feature can be turned on or off through the Electronic Vehicle Information Center (EVIC) (if equipped). Refer to "Headlights With Wipers," under "Personal Settings (Customer Programmable Features)" under "Electronic Vehicle Information Center" in Section 4.

### **Headlight Time Delay — If Equipped**

This feature is particularly useful when exiting your vehicle in an unlit area. It provides the safety of headlight illumination for up to 90 seconds after turning the ignition switch to the LOCK position.

To activate the delay, turn the ignition switch to the LOCK position while the headlights are still on. Then, turn OFF the headlights within 45 seconds. The delay interval begins when you turn OFF the headlights. Only the headlights will illuminate during this time.

If you turn the headlights, or parking lights, or ignition switch ON again, the system will cancel the delay.

If you turn the headlights OFF before the ignition, they will turn off in the normal manner.

The headlight delay time is programmable on vehicles equipped with the EVIC. Refer to “Headlight Off Delay,” under “Personal Settings (Customer Programmable Features),” under “Electronic Vehicle Information Center (EVIC)” in Section 4.

#### **Daytime Running Lights (DRL) — If Equipped**

The high beam headlights will turn on as Daytime Running Lights (DRL) and operate at DRL (lower) intensity, whenever the ignition is ON, the engine is running, the HEADLIGHT switch is off, the parking brake is off, the turn signal is off, and the shift lever is in any position except PARK.

**NOTE:** The Daytime Running Lights will turn off automatically when the turn signal is in operation and turn on again when the turn signal is not operating.

#### **Lights-On Reminder**

If the headlights or parking lights are on after the ignition is turned to the LOCK position, a chime will sound to alert the driver when the driver’s door is opened.

#### **Fog Lights — If Equipped**

**#D** To activate the front fog lights, turn ON the parking lights or the low beam headlights and pull out on the end of the multifunction lever.

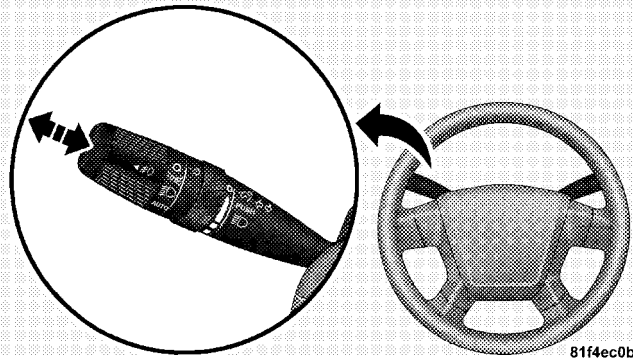

81f4ec0b

### Front Fog Light

**NOTE:** The front fog lights will only operate with the headlights on low beam. Selecting high beam headlights will turn off the front fog lights.

### Turn Signals

Move the multifunction lever upward or downward and the corresponding turn signal indicator on the instrument panel will flash to show proper operation of the front and rear turn signal lights.

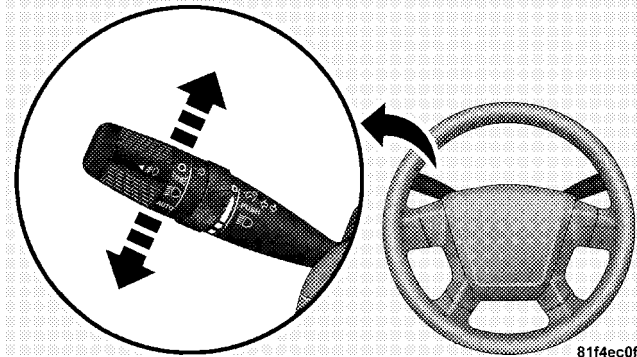

81f4ec0f

### Turn Signal Control

You can signal a lane change by moving the lever upward or downward partially without moving beyond the detent.

**NOTE:** If either turn signal indicator has a very fast flash rate, check for an inoperative outside light bulb. If an indicator fails to light when the lever is moved, see your authorized dealer for service.

### Highbeam/Lowbeam Select Switch

Push the multifunction lever away from you to switch the headlights to HIGH beam. Pull the Lever toward you, to switch the headlights back to LOW beam.

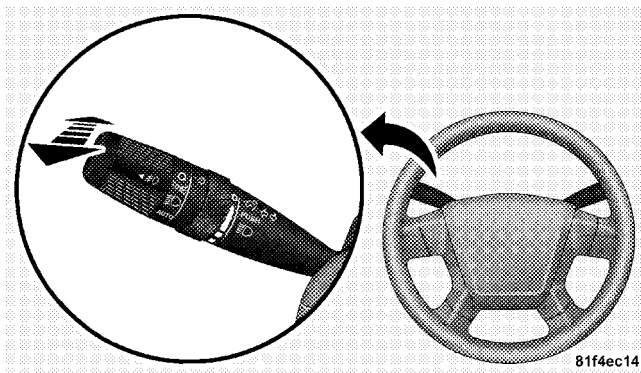

81f4ec14

Highbeam Control

## Flash to Pass

You can signal another vehicle with your headlights by lightly pulling the multifunction lever toward you. This will cause the headlights to turn on at high beam and remain on until the lever is released.

**NOTE:** If the multifunction lever is held in the Flash to Pass position for more than 15 seconds, the high beams will shut off. If this occurs, wait 30 seconds before activating the Flash to Pass function again.

## Interior Lights

### Courtesy/Reading Lights

#### *Models with Overhead Console*

These lights are mounted in the overhead console between the sun visors. They are also located in the headliner above the second row passenger seats. Press and release the lens to turn ON or turn OFF the light manually. These lights also turn on when you press the

UNLOCK button on the Remote Keyless Entry (RKE) transmitter, open a door or the liftgate, or turn the Dimmer Control completely upward to the second detent. For models equipped with LED lighting, you can swivel the lens socket to direct the light as desired.

#### *Models without Overhead Console*

There are two courtesy/reading lights mounted in the headliner between the sun visors. Press and release the button next to the lens to turn ON or turn OFF the light manually. A courtesy light is also mounted in the headliner above the second row passenger seats. Press and release the lens to turn ON or turn OFF the light manually. These lights also turn on when you press the UNLOCK button on the RKE transmitter, open a door or the liftgate, or turn the Dimmer Control completely upward to the second detent.

### Cargo Light

This light is mounted in the liftgate trim panel. It turns on when you press the UNLOCK button on the RKE transmitter, open a door or the liftgate, or turn the Dimmer Control completely upward to the second detent.

### Battery Saver Feature

To protect the battery, the interior lights will turn off automatically within 10 minutes of turning the ignition switch to the LOCK position. This will occur if the interior lights were switched ON manually or are on because a door is open.

### Dimmer Control

The Dimmer Control is part of the multifunction lever. It controls the operation of the interior lights and the brightness of the instrument panel lights.

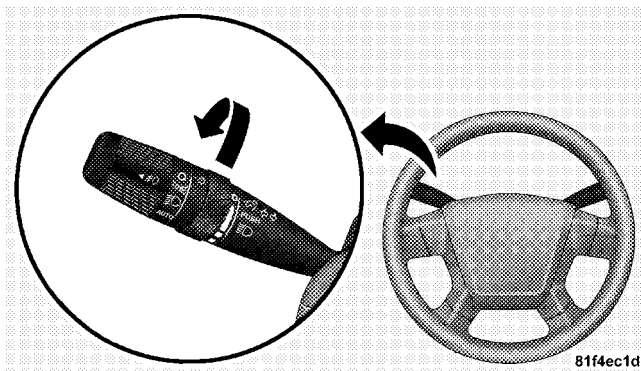

Dimmer Control

### Instrument Panel Dimming

With the parking lights or headlights on, rotate the Dimmer Control upward or downward to change the brightness of the instrument panel lights.



**Parade Mode (Daytime Brightness Feature)**

Rotate the Dimmer Control to the first detent to brighten the odometer and radio display when the parking lights or headlights are on during daylight conditions.

**Interior Light ON**

Rotate the Dimmer Control completely upward to the second detent to turn ON the interior lights.

**NOTE:** The Battery Saver feature will not activate until the ignition switch is in the LOCK position. Refer to “Battery Saver Feature” for additional information.

**Interior Light Defeat OFF**

Rotate the Dimmer Control completely downward to the (O) OFF position. The interior lights will remain off when the doors are open.

**WINDSHIELD WIPERS AND WASHERS**

The Windshield Wiper/Washer control lever is located on the right side of the steering column.

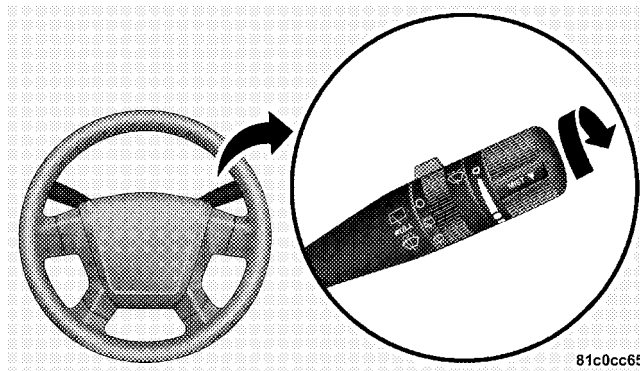

81c0cc65

**Windshield Wiper/Washer Lever**

Rotate the end of the lever to the first detent past the intermittent settings for low speed wiper operation, or to the second detent past the intermittent settings for high speed wiper operation.

**NOTE:** The wipers will automatically return to the park position if you turn OFF the ignition switch while they are operating. The wipers will resume operation when you turn the ignition switch to the ON position again.

### CAUTION!

- **Turn the windshield wipers OFF when driving through an automatic car wash. Damage to the windshield wipers may result if the wiper control is left in any position other than OFF.**
- **In cold weather, always turn OFF the WIPER switch and allow the wipers to return to the park position before turning OFF the engine. If the WIPER switch is left ON and the wipers freeze to the windshield, damage to the wiper motor may occur when the vehicle is restarted.**
- **Always remove any buildup of snow that prevents the windshield wiper blades from returning to the park position. If the windshield wiper control is turned OFF and the blades cannot return to the park position, damage to the wiper motor may occur.**

### Intermittent Wiper System

Use the intermittent wiper system when weather conditions make a single wiping cycle with a variable pause between cycles desirable. Rotate the end of the Windshield Wiper/Washer control lever to the first detent, and then turn the end of the lever to select the desired delay interval. There are five delay settings, which allow you to regulate the wipe interval from a minimum of two cycles every second to a maximum of approximately 36 seconds between cycles or from a minimum of one cycle every second to a maximum of approximately 18 seconds between cycles at vehicle speeds greater than 10 mph (16 km/h).

### Mist Feature

Push downward on the Windshield Wiper/Washer control lever to activate a single wipe cycle to clear the windshield of road mist or spray from a passing vehicle. The wipers will continue to operate until you release the lever.

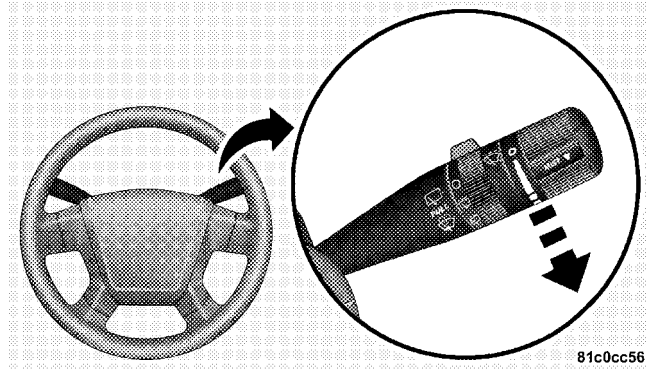

81c0cc56

Mist Control

### **Headlights with Wipers (Available with Auto Headlights Only)**

When this feature is active, the headlights will turn on approximately 10 seconds after the wipers are turned ON if the multifunction lever (on the left side of the steering column) is placed in the (A) AUTO position. In addition, the headlights will turn off when the wipers are turned OFF if they were turned ON by this feature.

The Headlights with Wipers feature can be turned on or off through the Electronic Vehicle Information Center (EVIC) (if equipped). Refer to "Headlights With Wipers," under "Personal Settings (Customer Programmable Features)," under "Electronic Vehicle Information Center" in Section 4.

### **Windshield Washers**

To use the washer, pull the Windshield Wiper/Washer control lever toward you and hold it for as long as washer spray is desired.

If you activate the washer while the wiper control is in the delay range, the wipers will operate in low speed for two wipe cycles after releasing the lever and then resume the intermittent interval previously selected.

If you activate the washer while the wiper control is in the OFF position, the wipers will operate for two wipe cycles and then turn OFF.

**WARNING!**

**Sudden loss of visibility through the windshield could lead to an accident. You might not see other vehicles or other obstacles. To avoid sudden icing of the windshield during freezing weather, warm the windshield with the defroster before and during windshield washer use.**

**Adding Washer Fluid**

**NOTE:** Refer to the “Engine Compartment” diagram in Section 7 for the location of the washer fluid reservoir.

The fluid reservoir for the windshield washers is located in the engine compartment. Be sure to check the fluid level in the reservoir at regular intervals. Fill the reservoir with windshield washer solvent (not radiator antifreeze) and operate the system for a few seconds to flush out the residual water.

**WARNING!**

**Commercially available windshield washer solvents are flammable. They could ignite and burn you. Care must be exercised when filling or working around the washer solution.**

## TILT/TELESCOPING STEERING COLUMN — IF EQUIPPED

This feature allows you to tilt the steering column upward or downward. It also allows you to lengthen or shorten the steering column. The tilt/telescoping control handle is located below the steering wheel at the end of the steering column.

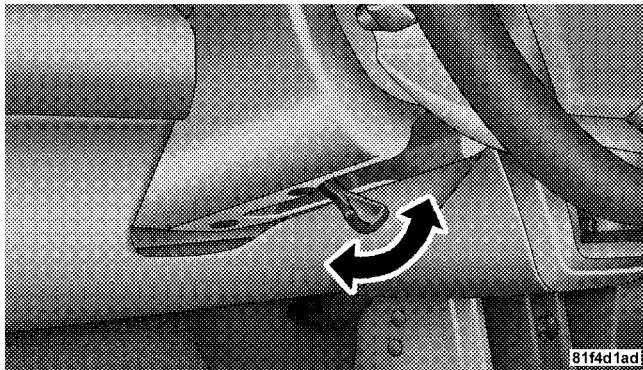

**Tilt/Telescoping Steering Wheel Lock**

To unlock the steering column, push the control handle downward. To tilt the steering column, move the steering wheel upward or downward as desired. To lengthen or shorten the steering column, pull the steering wheel outward or push it inward as desired. To lock the steering column in position, pull the control handle upward until fully engaged.

### **WARNING!**

**Do not adjust the steering wheel while driving. The tilt/telescoping adjustment must be locked while driving. Adjusting the steering wheel while driving or driving without the tilt/telescoping adjustment locked could cause the driver to lose control of the vehicle. Failure to follow this warning may result in serious injury or death.**

**ELECTRONIC SPEED CONTROL — IF EQUIPPED**

When engaged, this device takes over the accelerator operation at speeds greater than 25 mph (40 km/h).

**Electronic Speed Control Operation**

The speed control lever is located on the right side of the steering wheel.

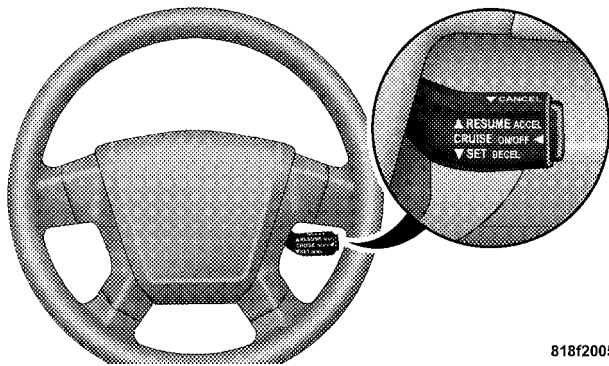

818f2005

**Speed Control Lever****To Activate**

Push and release the ON/OFF button located on the end of the speed control lever. The Cruise Indicator Light in the instrument cluster will illuminate. To turn the system OFF, push and release the ON/OFF button a second time. The Cruise Indicator Light will turn off. Be sure to turn the system OFF when not in use.

**NOTE:**

- The Electronic Speed Control System will automatically turn off when the engine is turned OFF.
- The Electronic Speed Control System is designed to shut down if you operate multiple speed control switch-functions simultaneously (i.e., Set and Cancel). If this occurs, push and release the ON/OFF button to reactivate the system and then reestablish the desired Set speed.

**WARNING!**

Leaving the Electronic Speed Control system on when not in use is dangerous. You could accidentally set the system or cause it to go faster than you want. You could lose control and have an accident. Always leave the system OFF when you are not using it.

**To Set At A Desired Speed**

When the vehicle reaches the speed desired, press downward on the lever to SET DECEL and release. Release the accelerator pedal and the vehicle will operate at the selected speed.

**NOTE:**

- The vehicle must be traveling at least 25 mph (40 km/h) for the speed control to set.

- The vehicle should be traveling at a steady speed and on level ground before pressing the lever to SET DECEL.

**To Deactivate**

A soft tap on the brake pedal, or pulling the speed control lever toward you to CANCEL, or normal brake pressure while slowing the vehicle will deactivate the speed control without erasing the set speed from memory. Pressing the ON/OFF button or turning OFF the ignition erases the set speed from memory.

**To Resume Speed**

If you deactivate the speed control without erasing the set speed from memory and your vehicle speed is above 20 mph (32 km/h) you can resume the previous set speed. To do so, push the lever upward to RESUME ACCEL and release, and then remove your foot from the accelerator pedal.



### To Vary the Speed Setting

When the speed control is set, you can increase speed by pushing up and holding the lever in RESUME ACCEL. Release the lever when the desired speed is reached, and the new set speed will be established.

Tapping RESUME ACCEL once will result in a 1 mph (1.6 km/h) speed increase. Each time the lever is tapped, speed increases so that tapping the lever three times will increase speed by 3 mph (5 km/h), etc.

To decrease speed while the speed control is set, push downward and hold the lever in SET DECEL. Release the lever when the desired speed is reached, and the new set speed will be established.

Tapping SET DECEL once will result in a 1 mph (1.6 km/h) speed decrease. Each time the lever is tapped, speed decreases.

### To Accelerate For Passing

Depress the accelerator pedal as you would normally. When the pedal is released, the vehicle will return to the set speed.

### Using Speed Control on Hills

**NOTE:** The speed control system maintains speed up and down hills. A slight speed change on moderate hills is normal.

On steep hills, a greater speed loss or gain may occur so it may be preferable to drive without speed control.

**WARNING!**

**Speed Control can be dangerous where the system can't maintain a constant speed. Your vehicle could go too fast for the conditions, and you could lose control. An accident could be the result. Don't use Speed Control in heavy traffic or on roads that are winding, icy, snow-covered, or slippery.**

**OVERHEAD CONSOLE**

The overhead console contains courtesy/reading lights, storage for sunglasses, an interior observation mirror, and an optional power SUNROOF switch.

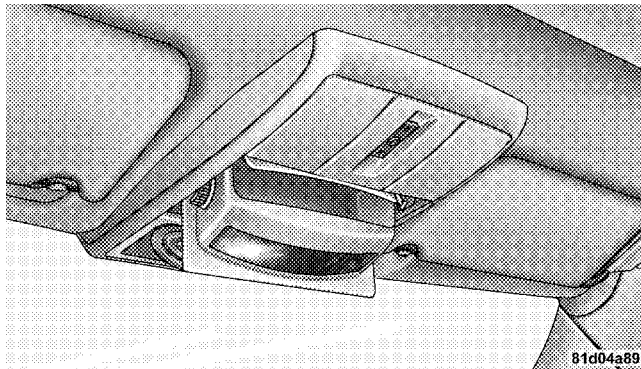

**Overhead Console**

**Courtesy/Reading Lights**

Refer to “Courtesy/Reading Lights” under “Lights” in Section 3.

**Sunglasses Storage**

To access the storage compartment, press on the raised bars on the compartment door in the center of the console and release and the door will swing downward.

**Interior Observation Mirror**

The convex interior observation mirror provides the driver and front seat passenger a wide field of view to conveniently view passengers sitting in the rear passenger seats. To use the interior observation mirror, first, press on the raised bars on the compartment door and release. The door will swing downward. Then, raise the door until it is almost closed and release. The door will latch in position to use the interior observation mirror.

**Power Sunroof Switch — If Equipped**

Refer to “Power Sunroof” in Section 3.

**GARAGE DOOR OPENER — IF EQUIPPED**

HomeLink® replaces up to three remote controls (hand-held transmitters) that operate devices such as garage door openers, motorized gates, lighting, or home security systems. The HomeLink® unit operates off your vehicle’s battery.

The HomeLink® buttons that are located in the sun visor designate the three different HomeLink® channels.

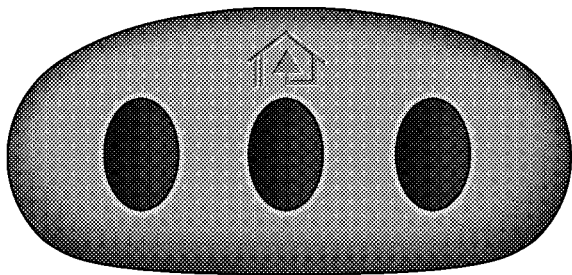

81cb44fe

### HomeLink® Buttons

**NOTE:** HomeLink® is disabled when the Vehicle Security Alarm is active.

### WARNING!

Your motorized door or gate will open and close while you are training the Universal Transceiver. Do not train the transceiver if people or pets are in the path of the door or gate. Only use this transceiver with a garage door opener that has a “stop and reverse” feature as required by Federal safety standards. This includes most garage door opener models manufactured after 1982. Do not use a garage door opener without these safety features. Call toll-free 1-800-355-3515 or, on the Internet at [www.HomeLink.com](http://www.HomeLink.com) for safety information or assistance.

**WARNING!**

**Vehicle exhaust contains carbon monoxide, a dangerous gas. Do not run your vehicle in the garage while training the transceiver. Exhaust gas can cause serious injury or death.**

**Programming HomeLink®****Before You Begin**

If you have not trained any of the HomeLink® buttons, erase all channels before you begin training.

To do this, press and hold the two outside buttons for 20 seconds until the red indicator flashes.

It is recommended that a new battery be placed in the hand-held transmitter of the device being programmed to HomeLink® for more efficient training and accurate transmission of the radio-frequency signal.

Your vehicle should be parked outside of the garage when programming.

1. Turn the ignition switch to the ON/RUN position.
2. Hold the battery side of the hand-held transmitter away from the HomeLink® button you wish to program.

Place the hand-held transmitter 1–3 in (3–8 cm) away from the HomeLink® button you wish to program while keeping the indicator light in view.

3. Simultaneously press and hold both the chosen HomeLink® button and the hand-held transmitter button until the HomeLink® indicator changes from a slow to a rapidly blinking light, then release both the HomeLink® and hand-held transmitter buttons.

Watch for the HomeLink® indicator to change flash rates. When it changes, it is programmed. It may take up to 30 seconds, or longer in rare cases. The garage door may open and close while you train.

**NOTE:**

- Some gate operators and garage door openers may require you to replace Step 3 with procedures noted in the “Gate Operator/Canadian Programming” section.
  - After training a HomeLink® channel, if the garage door does not operate with HomeLink® and the garage door opener was manufactured after 1995, the garage door opener may have a rolling code. If so, proceed to the heading “Programming A Rolling Code System.”
4. Press and hold the just-trained HomeLink® button and observe the indicator light.

If the indicator light stays on constantly, programming is complete and the garage door (or device) should activate when the HomeLink® button is pressed.

If the indicator light blinks rapidly for two seconds, and then turns to a constant light, continue with programming for a Rolling Code.

**5. PROGRAMMING A ROLLING CODE SYSTEM**

At the garage door opener motor (in the garage), locate the “Learn” or “Training” button.

This can usually be found where the hanging antenna wire is attached to the garage door opener motor (it is NOT the button normally used to open and close the door).

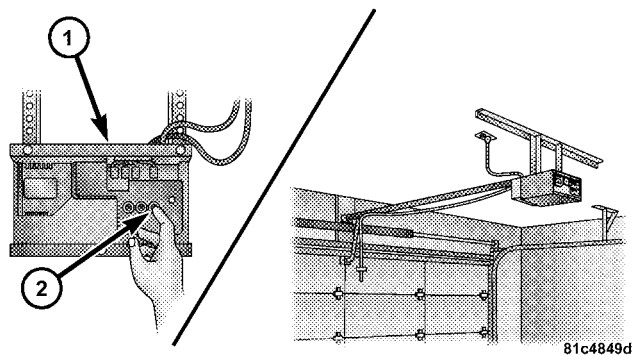

1 — Garage Door Opener

2 — Training Button

6. Firmly press and release the “Learn” or “Training” button. The name and color of the button may vary by manufacturer.

**NOTE:** There are 30 seconds in which to initiate the next step after the “Learn” button has been pressed.

7. Return to the vehicle and press the programmed HomeLink® button twice (holding the button for two seconds each time). If the device is plugged in and activates, programming is complete.

If the device does not activate, press the button a third time (for two seconds) to complete the training.

If you have any problems, or require assistance, please call toll-free 1-800-355-3515 or, on the Internet at [www.HomeLink.com](http://www.HomeLink.com) for information or assistance.

To program the remaining two HomeLink® buttons, repeat each step for each remaining button. **DO NOT** erase the channels.

### Gate Operator/Canadian Programming

Canadian radio-frequency laws require transmitter signals to “time-out” (or quit) after several seconds of transmission – which may not be long enough for HomeLink® to pick up the signal during programming.

Similar to this Canadian law, some U.S. gate operators are designed to “time-out” in the same manner.

It may be helpful to unplug the device during the cycling process to prevent possible overheating of the garage door or gate motor.

If you are having difficulties programming a garage door opener or a gate operator, replace “Programming HomeLink®” Step 3 with the following:

**3. Continue to press and hold the HomeLink® button while you press and release - every two seconds (“cycle”) your hand-held transmitter until HomeLink® has successfully accepted the frequency signal. The indicator light will flash slowly and then rapidly when fully trained.**

If you unplugged the device for training, plug it back in at this time.

Then proceed with Step 4 under “Programming HomeLink®” earlier in this section.

### **Using HomeLink®**

To operate, simply press and release the programmed HomeLink® button. Activation will now occur for the trained device (i.e., garage door opener, gate operator, Security system, entry door lock, home/office lighting, etc. The hand-held transmitter of the device may also be used at any time.

### **Reprogramming A Single HomeLink® Button**

To re-program a channel that has been previously trained, follow these steps:

1. Turn the ignition switch to the ON/RUN position.
2. Press and hold the desired HomeLink® button until the indicator light begins to flash after 20 seconds. **Do not release the button.**



3. **Without releasing the button**, proceed with Programming Homelink® Step 2 and follow all remaining steps.

### Security

It is advised to erase all channels before you sell or turn in your vehicle.

To do this, press and hold the two outside buttons for 20 seconds until the red indicator flashes. Note that all channels will be erased. Individual channels cannot be erased.

The HomeLink® Universal Transceiver is disabled when the Vehicle Security Alarm is active.

### Troubleshooting Tips

If you are having trouble programming HomeLink®, here are some of the most common solutions:

- Replace the battery in the original transmitter.

- Press the “Learn” button on the Garage Door Opener to complete the training for a Rolling Code.
- Did you unplug the device for training, and remember to plug it back in?

If you have any problems, or require assistance, please call toll-free 1-800-355-3515 or, on the Internet at [www.HomeLink.com](http://www.HomeLink.com) for information or assistance.

### General Information

This device complies with FCC rules Part 15 and Industry Canada RSS-210. Operation is subject to the following two conditions:

1. This device may not cause harmful interference
2. This device must accept any interference that may be received including interference that may cause undesired operation

**NOTE:** The transmitter has been tested and it complies with FCC and IC rules. Changes or modifications not expressly approved by the party responsible for compliance could void the user's authority to operate the device.

The term IC before the certification/registration number only signifies that Industry Canada technical specifications were met.

### **POWER SUNROOF — IF EQUIPPED**

The power sunroof switch is located between the sun visors on the overhead console.

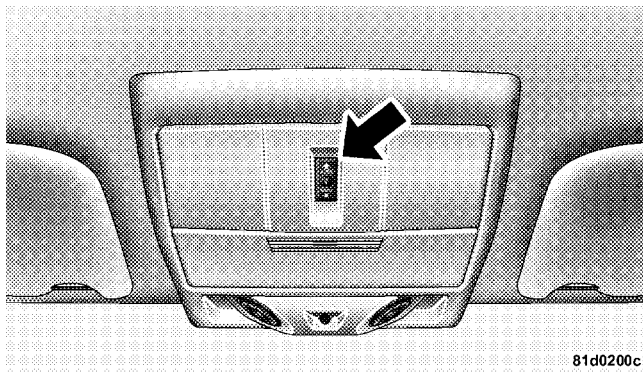

81d0200c

**Power Sunroof Switch**

**WARNING!**

- **Never leave children in a vehicle, with the key in the ignition switch. Occupants, particularly unattended children, can become entrapped by the power sunroof while operating the power SUN-ROOF switch. Such entrapment may result in serious injury or death.**
- **In an accident, there is a greater risk of being thrown from a vehicle with an open sunroof. You could also be seriously injured or killed. Always fasten your seat belt properly and make sure all passengers are also properly secured.**
- **Do not allow small children to operate the sunroof. Never allow fingers or other body parts, or any object to project through the sunroof opening. Injury may result.**

**Opening Sunroof - Manually**

Press and hold the switch in the rearward position. Release the switch when the sunroof is in the position desired and it will stop moving. If you continue to hold the switch in the rearward position, the sunroof will open fully and then stop automatically. Release the switch once the sunroof stops moving.

**Opening Sunroof - Express**

Press the switch rearward and release, and the sunroof will open automatically from any position. The sunroof will open fully and then stop automatically. This is called Express Open. During Express Open operation, any movement of the sunroof switch will stop the sunroof.

**Closing Sunroof - Manually**

Press and hold the switch in the forward position. Release the switch when the sunroof is in the position desired and it will stop moving. If you continue to hold

the switch in the forward position, the sunroof will close fully and then stop automatically. Release the switch once the sunroof stops moving.

### **Closing Sunroof - Express**

Press the switch forward and release, and the sunroof will close automatically from any position. The sunroof will close fully and stop automatically. This is called Express Close. During Express Close operation, any movement of the sunroof switch will stop the sunroof.

### **Pinch Protect Feature**

This feature will detect an obstruction in the opening of the sunroof during Express Close operation. If an obstruction in the path of the sunroof is detected, the sunroof will automatically retract. Remove the obstruction if this occurs. Next, press the switch forward and release to Express Close.

### **Pinch Protect Override**

If a known obstruction (ice, debris, etc.,) prevents closing, press the switch forward and hold for two seconds after the reversal occurs. This allows the sunroof to move towards the closed position.

**NOTE:** Pinch protection is disabled while the switch is pressed.

### **Venting Sunroof - Express**

Press and release the "V" button in the center of the switch, and the sunroof will open to the vent position. This is called Express Vent, which operates regardless of sunroof position. During Express Vent operation, any movement of the SUNROOF switch will stop the sunroof.

### **Sunshade Operation**

The sunshade can be opened manually. However, the sunshade will open automatically as the sunroof opens.

**NOTE:** The sunshade cannot be closed if the sunroof is open.

### **Wind Buffeting**

Wind buffeting can be described as the perception of pressure on the ears or a helicopter type sound in the ears. Your vehicle may exhibit wind buffeting with the windows down, or the sunroof in certain open or partially open positions. This is a normal occurrence and can be minimized. If the buffeting occurs with the rear windows open, then open the front and rear windows together to minimize the buffeting. If the buffeting occurs with the sunroof open, then adjust the sunroof opening to minimize the buffeting or open any window.

### **Sunroof Maintenance**

Use only a non-abrasive cleaner and a soft cloth to clean the glass panel.

### **Ignition Off Operation**

For vehicles not equipped with the Electronic Vehicle Information Center (EVIC), the power sunroof switch will remain active for 45 seconds after the ignition switch is turned to the LOCK position. Opening either front door will cancel this feature.

For vehicles equipped with the EVIC, the power SUNROOF switch will remain active for up to 10 minutes after the ignition switch is turned to the LOCK position. Opening either front door will cancel this feature. The time is programmable. Refer to “Key-Off Power Delay,” under “Personal Settings (Customer Programmable Features),” under “Electronic Vehicle Information Center (EVIC)” in Section 4.

### Sunroof Fully Closed

Press the switch forward and release to ensure that the sunroof is fully closed.

### ELECTRICAL POWER OUTLETS

There are two fused 12-Volt power outlets located in the center console below the radio. The outlet on the top has power available when the ignition switch in the ON or ACC position. The outlet on the bottom has power available when the ignition switch is in the LOCK, ON, or ACC position.

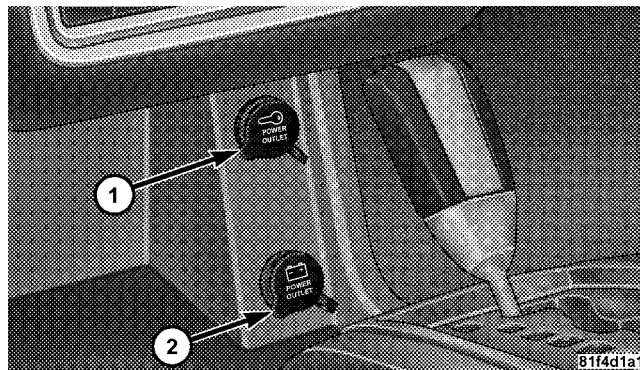

**Front Power Outlets**

1 - Switched Power

2 - Battery Power

A third fused 12-Volt power outlet is located on the back of the center console. This outlet has power available when the ignition switch is in the LOCK, ON or ACC position.

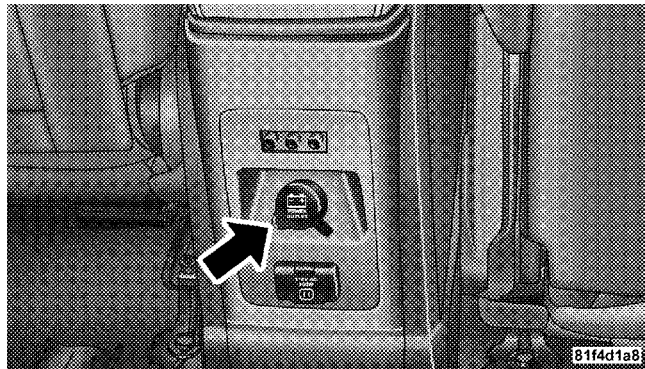

**Rear Power Outlet**

A fourth fused 12-Volt power outlet is located on the left quarter trim panel in the cargo area. This outlet has power available when the ignition switch is in the ON or ACC position.

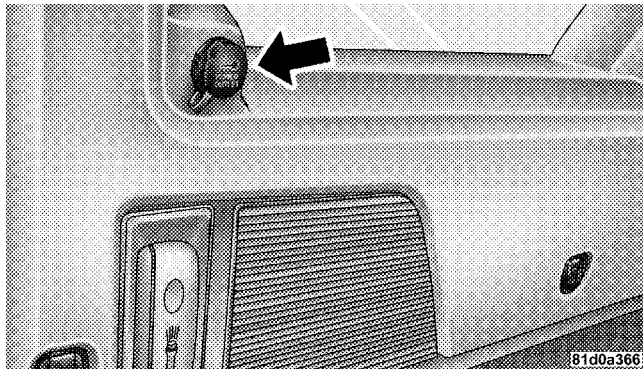

## Electrical Outlet Use With Engine Off

### CAUTION!

- Many accessories that can be plugged in draw power from the vehicle's battery, even when not in use (i.e., cellular phones, etc.). Eventually, if plugged in long enough, the vehicle's battery will discharge sufficiently to degrade battery life and/or prevent engine starting.
- Accessories that draw higher power (i.e., coolers, vacuum cleaners, lights, etc.) will degrade the battery even more quickly. Only use these intermittently and with greater caution.
- After the use of high power draw accessories, or long periods of the vehicle not being started (with accessories still plugged in), the vehicle must be driven a sufficient length of time to allow the alternator to recharge the vehicle's battery.
- Power outlets are designed for accessory plugs only. Do not hang any type of accessory or accessory bracket from the plug.

## POWER INVERTER — If EQUIPPED

Your vehicle may be equipped with a 115 Volt AC (150 Watt maximum) power outlet located on the back of the center console. This outlet can power small appliances and electronic devices.

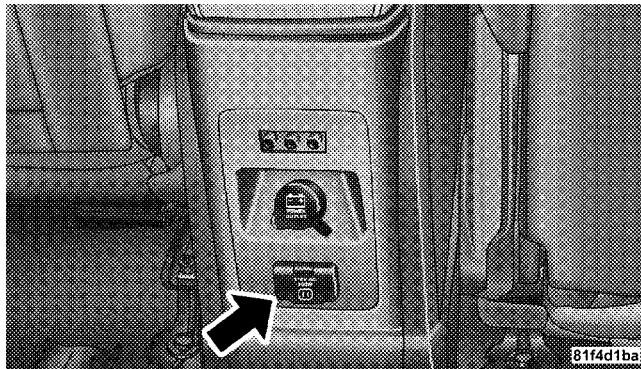

Power Inverter



The control switch for the outlet is located in the switch bank above the climate control.

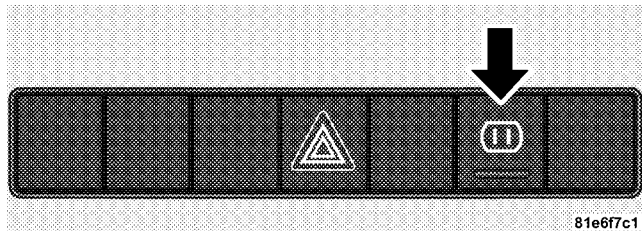

#### Power Inverter Switch

Press and release the switch once to turn ON the power outlet. A status indicator in the switch will illuminate in approximately one second to indicate that power is available at the outlet. Press and release the switch again to turn OFF the power outlet. The status indicator will also turn off.

**NOTE:** Due to built-in overload protection, the power outlet will shut down if the 115 Volt AC (150 Watt maximum) power rating is exceeded.

#### WARNING!

##### To Avoid Serious Injury or Death:

- Do not use a three-prong adaptor.
- Do not insert any objects into the receptacles.
- Do not touch with wet hands.
- Close the lid when not in use.
- If this outlet is mishandled, it may cause an electric shock and failure.

## CUP AND BOTTLE HOLDERS

### CUPHOLDERS

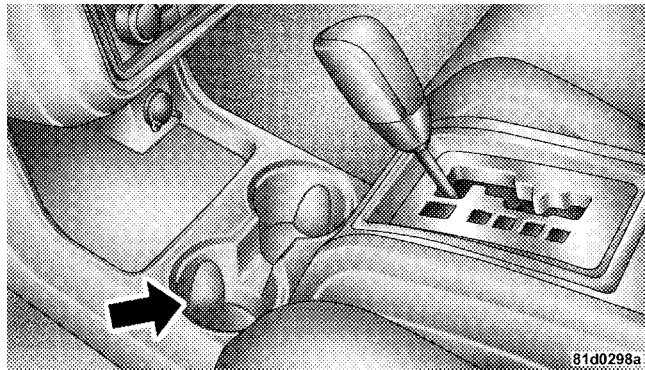

**Center Console Cupholders**

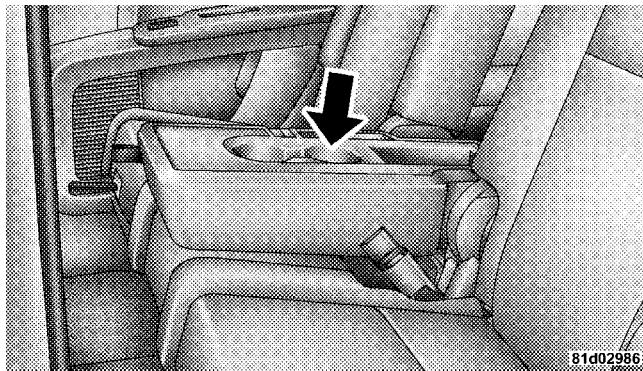

**Armrest Cupholders**

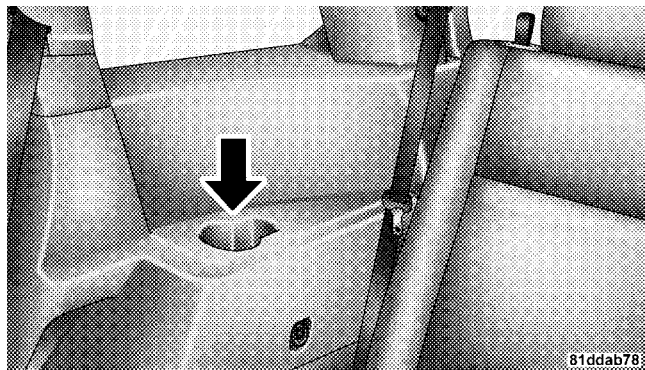

**Quarter Trim Panel Cupholders  
(Seven Passenger Models)**

## BOTTLE HOLDERS

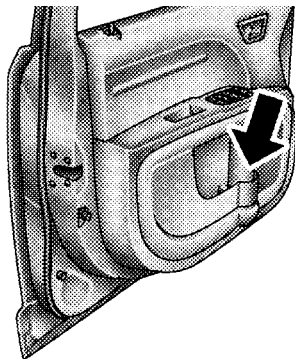

**Door Bottle Holder**

**WARNING!**

If containers of hot liquid are placed in the bottle holder, they can spill when the door is closed, burning the occupants. Be careful when closing the doors to avoid injury.

**STORAGE****Beverage Cooler/Storage Compartment — If Equipped**

**NOTE:** The Beverage Cooler can keep chilled beverages cool depending on ambient temperature and climate control setting. The cooler is intended for non-perishable beverages only.

The Beverage Cooler/Storage Compartment is located on the passenger's side of the instrument panel above the glove compartment. The beverage retainer inside the

cooler is designed to hold up to two 12 oz (0.35 l) cans when placed horizontally in the retainer. The beverage retainer is removable to allow for storage of other items in the compartment when not in use as a cooler.

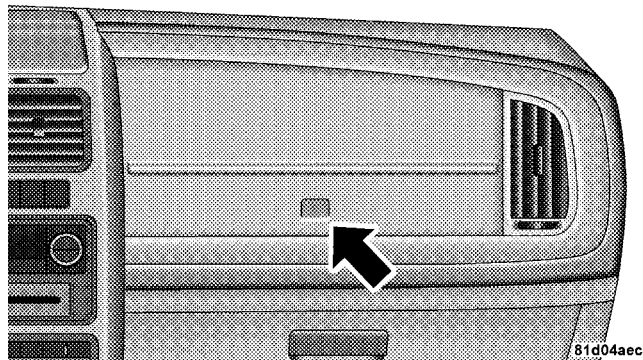

**Beverage Cooler/Storage Compartment**

Press and release the button on the door to open it. The large door swings upward to allow easy access to the compartment's contents.

### **Beverage Cooler Operation**

The blower speed setting on the climate control sets the rate at which air flows into the compartment. The airflow control valve inside the compartment determines how much air flows into the compartment. Turning the valve rearward increases the airflow, turning it forward decreases the airflow, and turning it all the way forward turns off the airflow.

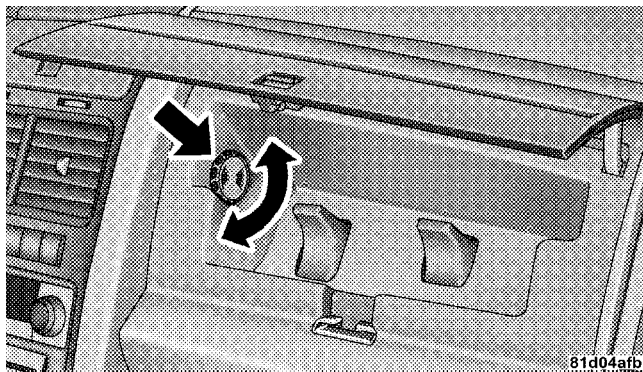

3

### **Airflow Control Valve**

The compartment cools when the airflow control valve is open, the engine is running, and the Air Conditioning (A/C) is on or the Automatic Temperature Control (ATC) system (if equipped) is set for automatic operation. This allows you to cool the compartment when the climate control is in a cooling or heating mode.

**NOTE:** Whether operating a Manual Heating and A/C system or operating an ATC system in a manual mode, the A/C indicator must be ON to cool the compartment.

**Instrument Panel Storage Compartment — If Equipped**

Press and release the button on the door to open it. The door swings upward to allow easy access to the compartment.

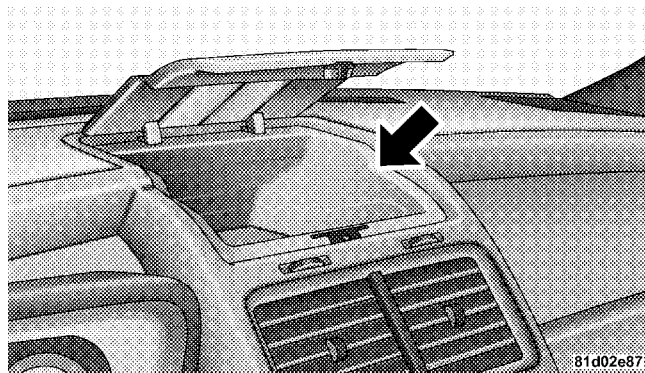

**Instrument Panel Storage Compartment**

### Center Console Storage

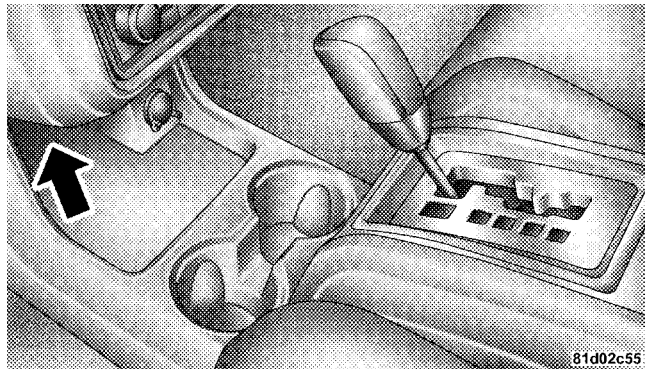

Center Stack Cubby Bin

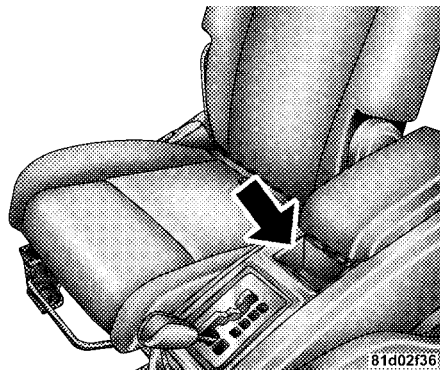

Center Console Cubby Bin

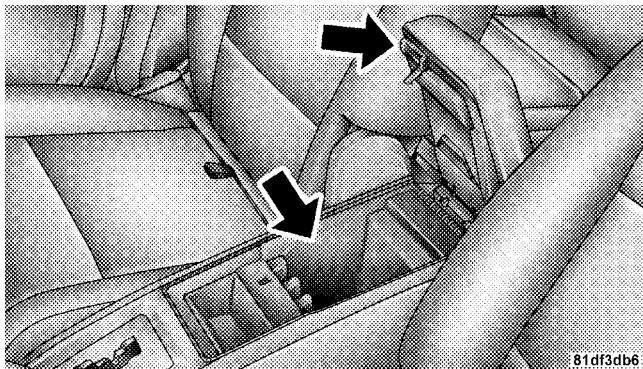

### Center Console Storage Bin

**NOTE:** The sliding armrest (if so equipped) must be in the rearward position in order to access the release button on the front of the bin door.

### Flip 'n Stow™ Front Passenger Seat Storage — If Equipped

The seat latch release-loop is located in the center of the seat cushion between the seat cushion and the seatback. Pull the loop upward to release the latch and then forward to open the seat to the detent position.

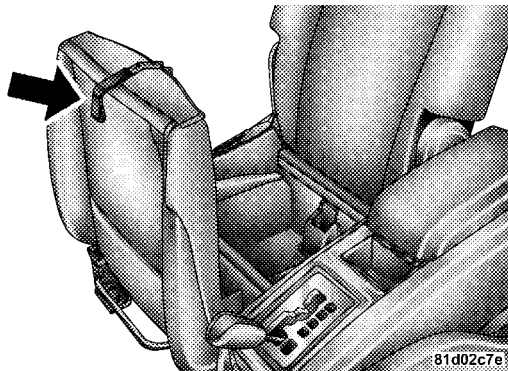

### Front Passenger Seat Storage Compartment



**NOTE:** Make sure that objects inside the bin do not interfere with the latch before closing the seat. Push the seat cushion downward after closing it to make sure it latches to the base.

### **WARNING!**

Be certain that the seat cushion is locked securely into position before using the seat. Otherwise, the seat will not provide the proper stability for passengers. An improperly latched seat cushion could cause serious injury.

### **Second-Row Passenger Seat Temporary Storage Bin**

This is a temporary storage bin designed for use when the 20% seatback/armrest is down. Be sure to remove all items from this bin before raising the 20% seatback/armrest.

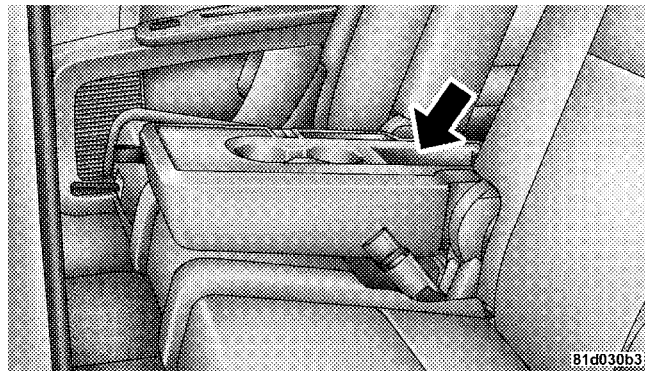

**Armrest Cubby Bin**

## Second-Row Map Pocket and Grocery Retainers

A map storage pocket and grocery retainers are located on the back of the drivers seatback.

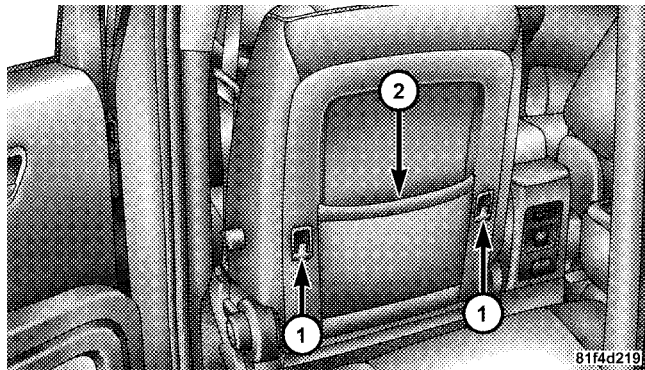

1 - Grocery Retainers

2 - Map Storage

## In-Floor Storage Bin with Removable Liner

**NOTE:** Position the front seat to at least a mid-track position to provide easier access to the storage bin.

An in-floor storage bin is located behind each front seat. Each 1.6 gal (5.9 l) bin can hold up to 12, 12 oz (0.35 l) cans, plus ice, or other items. The removable bin liner allows for easy filling, emptying, and cleaning.

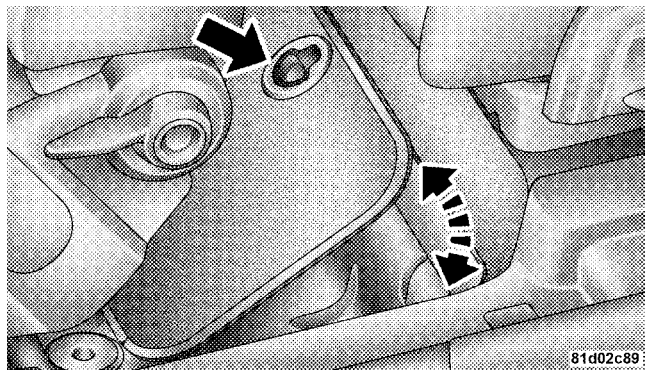

### In-Floor Storage Bin

To access the bin, position the floor mat aside (if equipped). Pull the door latch release-loop upward to release the latch and then forward to open the bin door.

The liner can be removed for easy cleaning by lifting on the notches as shown.

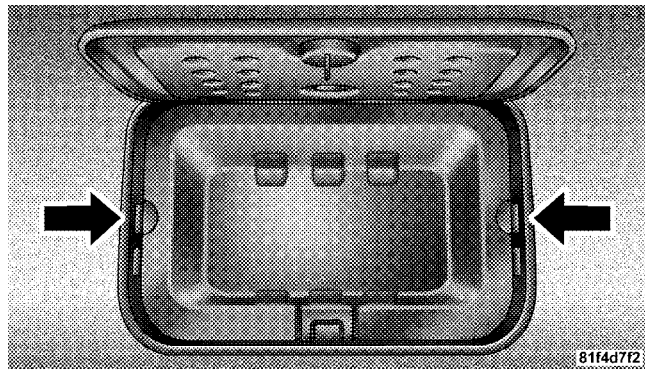

### Removable Liner

## CARGO AREA FEATURES

### Rechargeable Flashlight — If Equipped

The rechargeable LED flashlight stores in its charging station in the left rear quarter trim panel. To remove it, press on the indent on the side of the flashlight and release.

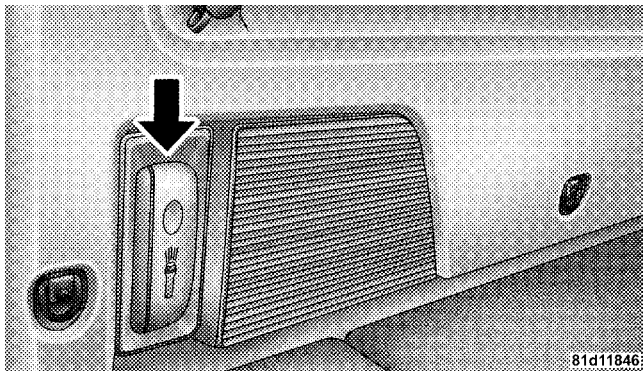

**Rechargeable Flashlight**

**NOTE:** Be sure to return the flashlight to its charging station when not in use to ensure it is ready for operation the next time you need it.

## Cargo Management System

### Five Passenger System Features

- A raised load floor that sits on top of a large built-in storage bin.
- A tri-fold door built into the load floor that allows easy access to items in the built-in storage bin.
- 60/40 split second-row passenger seats with fold flat feature, which allows for extended cargo space. Refer to “Seats” in this section.
- An optional front passenger seat with fold flat feature, which extends cargo space even further. Refer to “Seats” in this section.
- Cargo tie-downs.

- A retractable cargo area cover (if equipped).

### Seven Passenger System Features

- A large built-in storage bin with a hinged hardcover located in the floor behind the third-row passenger seats.
- 60/40 split second-row passenger seats with fold flat feature, which allows for extended cargo space. Refer to “Seats” in this section.
- 50/50 split third-row passenger seats with fold flat feature, which allows for extended cargo space. Refer to “Seats” in this section.
- An optional front passenger seat with fold flat feature, which extends cargo space even further. Refer to “Seats” in this section.
- Cargo tie-downs.

### Cargo Tie-Downs

Cargo tie-downs are located on both rear trim panels. These tie-downs should be used to secure loads safely when the vehicle is moving.

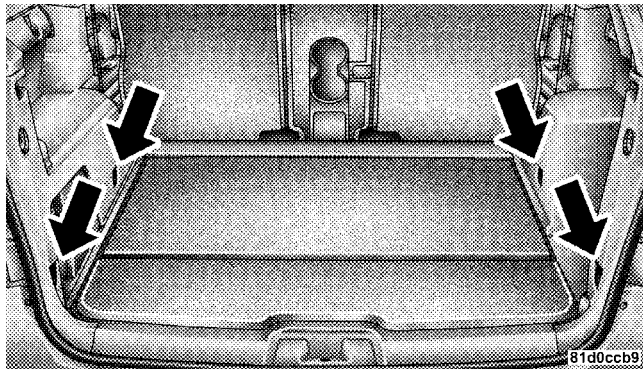

Cargo Tie-Downs

**WARNING!**

- **Cargo tie-downs are not safe anchors for a child seat tether strap. In a sudden stop or collision, a tie-down could pull loose and allow the child seat to come loose. A child could be badly injured. Use only the anchors provided for child seat tethers.**
- **The weight and position of cargo and passengers can change the vehicle center of gravity and vehicle handling. To avoid loss of control resulting in personal injury, follow these guidelines for loading your vehicle:**

- Do not carry loads that exceed the load limits described on the label attached to the left door or left door center pillar.

- Always place cargo evenly on the cargo floor. Put heavier objects as low and as far forward as possible.
- Place as much cargo as possible in front of the rear axle. Too much weight or improperly placed weight over or behind the rear axle can cause the vehicle to sway.
- Do not pile luggage or cargo higher than the top of the seatback. This could impair visibility or become a dangerous projectile in a sudden stop or collision.

**WARNING!**

**To help protect against personal injury, passengers should not be seated in the rear cargo area. The rear cargo space is intended for load carrying purposes only, not for passengers, who should sit in seats and use seat belts.**

### Retractable Cargo Area Cover (If Equipped) — Five Passenger Models

**NOTE:** The purpose of this cover is for privacy, not to secure loads. It will not prevent cargo from shifting or protect passengers from loose cargo.

The removable retractable cargo area cover mounts in the cargo area behind the top of the rear seats.

The cover, when extended, covers the cargo area to keep items out of sight. Notches in the trim panels near the liftgate opening secure the extended cover in place.

The cover rolls away neatly inside its housing when not in use. You can also remove the cover from the vehicle to make more room in the cargo area.

To install the cover, position it in the vehicle so that the flat side of the housing faces upward. Then, insert either

the left or the right spring-loaded post (located on the ends of the cover housing) into the left attachment point or the right attachment point (shown).

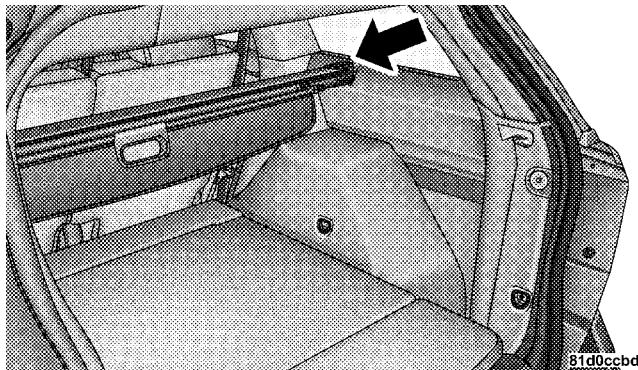

#### Installing Retractable Cargo Area Cover

Then, insert the spring-loaded post on the opposite end of the cover housing into the attachment point on the opposite side of the vehicle.

Next, grab the cover handle and pull the cover toward you. As the cover nears the liftgate opening, guide the rear attachment posts (on both ends of the cover) into the notches in the trim panels. Then, lower the cover to position the posts into the bottom of the notches and release the handle.

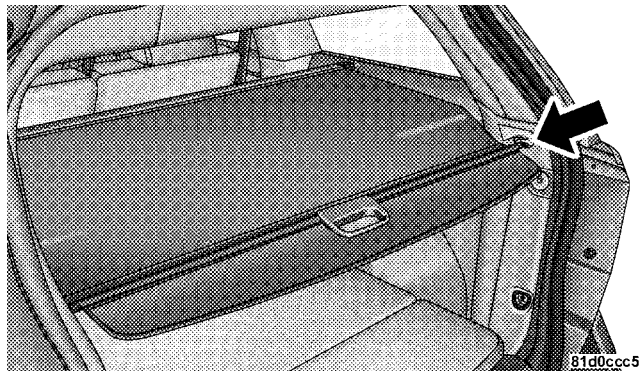

**Positioning Retractable Cargo Area Cover**

### **WARNING!**

**A cargo cover that is unsecured in the vehicle could cause injury in an accident. It could become airborne during a sudden stop and strike someone inside the vehicle. Do not store the cargo cover on the cargo floor or in the passenger compartment. Remove the cover from the vehicle when taken from its mounting. Do not store it in the vehicle.**



## REAR WINDOW FEATURES

### Rear Window Wiper/Washer — If Equipped

 The Rear Window Wiper/Washer Control is located on the right side of the steering column.

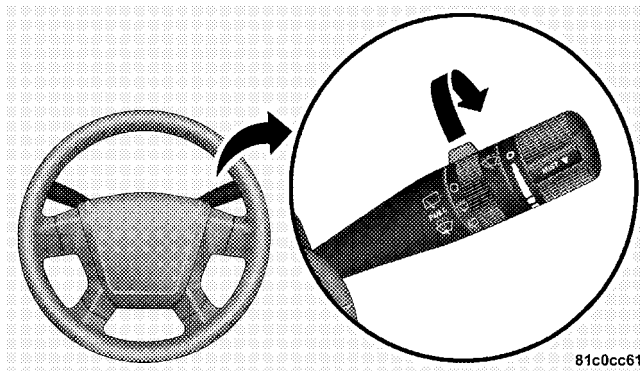

81c0cc61

**Rear Window Wiper/Washer Control**

The rotary ring switch on the lever controls rear wiper and washer operation. Rotate the switch upward to the first detent to activate the rear wiper. Rotate the switch upward to the second detent to activate the rear washer. The washer will continue to operate until you release the switch. Once released, the wiper will cycle three times, return to the park position, and then resume normal operation.

**NOTE:** The rear wiper will automatically return to the park position if you turn OFF the ignition switch while it is operating. The rear wiper will resume operation when you turn the ignition switch to the ON position again.

**CAUTION!**

- **Turn the rear wiper OFF when driving through an automatic car wash. Damage to the rear wiper may result if the REAR WIPER switch is left in the ON position.**
- **In cold weather, always turn OFF the REAR WIPER switch and allow the rear wiper to return to the park position before turning OFF the engine. If the REAR WIPER switch is left ON and the rear wiper freezes to the window, damage to the rear wiper motor may occur when the vehicle is restarted.**
- **Always remove any buildup of snow that prevents the rear wiper blade from returning to the park position. If the rear wiper control is turned OFF and the blade cannot return to the park position, damage to the rear wiper motor may occur.**

**Adding Washer Fluid**

**NOTE:** Refer to the “Engine Compartment” diagram in Section 7 for the location of the washer fluid reservoir.

The windshield washer and rear window washer share the same fluid reservoir. The reservoir is located in the front of the engine compartment. Be sure to check the fluid level at regular intervals. Fill the reservoir with windshield washer solvent (not radiator antifreeze) and operate the system for a few seconds to flush out the residual water.

### Rear Window Defroster — If Equipped



The Electric Rear Window Defroster control is located on the climate control. Press this button to turn on the rear window defroster and the heated outside rearview mirrors (if equipped). An indicator in the button will illuminate when the rear window defroster is on. The defroster automatically turns off after approximately 10 minutes. For five more minutes of operation, press the button again.

### CAUTION!

- Use care when washing the inside of the rear window. Do not use abrasive window cleaners on the interior surface of the window. Use a soft cloth and a mild washing solution, wiping parallel to the heating elements. Labels can be peeled off after soaking with warm water.
- Do not use scrapers, sharp instruments, or abrasive window cleaners on the interior surface of the window.
- Keep all objects a safe distance from the window.

Failure to follow these cautions can cause damage to the heating elements.

**ROOF LUGGAGE RACK — IF EQUIPPED**

The roof rack cross rails and side rails are designed to carry cargo weight. The load must not exceed 150 lbs (68 kg), and it should be distributed uniformly over the cross rails. In addition, the roof rack does not increase the total load carrying capacity of the vehicle. Be sure the total load of cargo inside the vehicle plus that on the roof rack does not exceed the maximum vehicle load capacity.

***To Move the Cross Rails***

1. Loosen the knobs on top of each cross rail approximately six turns to disengage the clamp tooth from the side rail.

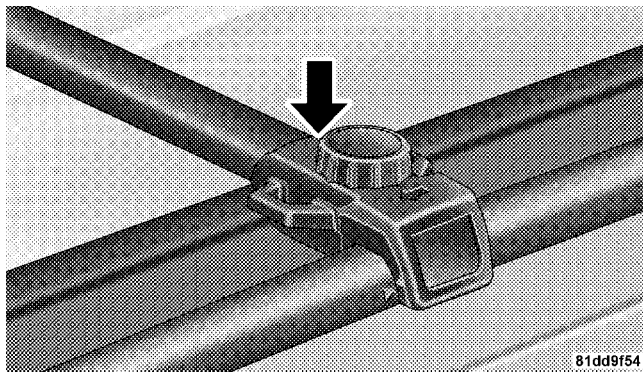
**Roof Luggage Rack**

2. Relocate the cross rails, aligning the cross rail stations (end pieces) with one of the vertical marks on the outboard surface of the side rail for proper positioning. There are four forward marks for the front cross rail and four rearward marks for the rear cross rail. Make sure the cross rails remain equally spaced or parallel at any position for proper function.

3. Tighten the knobs on each cross rail to lock it in position. As you tighten the knob, make sure the clamp tooth engages completely into the side rail slot.

4. Attempt to move the cross rail to ensure that it is locked in position.

**NOTE:**

- To help control wind noise when installing the cross rails, make sure the arrows marked on the underside of the cross rails face the front of the vehicle.
- To help reduce the amount of wind noise when the cross rails are not in use, fasten the front cross rail in the fourth position from the front and the rear cross rail in the eighth position.

The tie down holes on the cross rail ends should always be used to tie down the load. Check the straps frequently to be sure that the load remains securely attached.

**CAUTION!**

- Cross rails should remain equally spaced or parallel at any luggage rack position for proper function. Noncompliance could result in damage to the roof rack, cargo, and vehicle.
- To avoid damage to the roof rack and vehicle, do not exceed the maximum roof rack load capacity of 150 lbs (68 kg). Always distribute loads as evenly as possible and secure the load appropriately.
- Long loads, which extend over the windshield, such as wood panels or surfboards, or loads with large frontal area should be secured to both the front and rear of the vehicle.
- Place a blanket or other protection between the surface of the roof and the load.
- Travel at reduced speeds and turn corners carefully when carrying large or heavy loads on the roof rack. Wind forces, due to natural causes or nearby truck traffic, can add sudden upward lift to loads. This is especially true on large flat loads and may result in damage to the cargo or your vehicle.

**WARNING!**

Cargo must be securely tied before driving your vehicle. Improperly secured loads can fly off the vehicle, particularly at high speeds, resulting in personal injury or property damage. Follow the Roof Rack Cautions when carrying cargo on your roof rack.

# UNDERSTANDING YOUR INSTRUMENT PANEL

## CONTENTS

---

■ Instrument Panel Features . . . . .	201	□ Compass Display . . . . .	225
■ Instrument Cluster . . . . .	202	□ Personal Settings (Customer Programmable Features) . . . . .	227
■ Instrument Cluster Descriptions . . . . .	203	■ Radio General Information . . . . .	230
■ Electronic Vehicle Information Center (EVIC) — If Equipped . . . . .	218	□ Radio Broadcast Signals . . . . .	230
□ Electronic Vehicle Information Center (EVIC) Displays . . . . .	221	□ Two Types Of Signals . . . . .	231
□ Oil Change Required . . . . .	222	□ Electrical Disturbance . . . . .	231
□ Trip Functions . . . . .	223	□ AM Reception . . . . .	231
		□ FM Reception . . . . .	231

- Sales Code REN — Multimedia System — If Equipped . . . . .232
  - Operating Instructions — Satellite Radio (If Equipped) . . . . .232
  - Operating Instructions — Voice Recognition System (VR) (If Equipped) . . . . .233
  - Operating Instructions — Hands-Free Communication (UConnect®) (If Equipped) . . .233
  - Clock Setting Procedure . . . . .233
- Sales Code REQ — AM/FM Stereo Radio And 6-Disc CD/DVD Changer (MP3/WMA AUX Jack) . . . . .235
  - Operating Instructions - Radio Mode . . . . .235
  - Operation Instructions - (Disc Mode For CD And MP3/WMA Audio Play, DVD-Video) . . . .243
  - Notes On Playing MP3/WMA Files . . . . .245
  - List Button (Disc Mode For MP3/WMA Play) . . . . .248
  - Info Button (Disc Mode For MP3/WMA Play) . . . . .248
- Sales Code RES — AM/FM Stereo Radio With CD Player (MP3 AUX Jack) . . . . .250
  - Operating Instructions - Radio Mode . . . . .251
  - Operation Instructions - CD Mode For CD And MP3 Audio Play . . . . .256
  - Notes On Playing MP3 Files . . . . .258
  - List Button (CD Mode For MP3 Play) . . . . .261
  - Info Button (CD Mode For MP3 Play) . . . . .261



- Sales Code REU — Multimedia System — If Equipped . . . . .262
  - Operating Instructions — Satellite Radio . . . . .263
  - Operating Instructions — Hands-Free Communication (UConnect®) (If Equipped) . . .263
  - Clock Setting Procedure . . . . .263
- Satellite Radio — If Equipped (REN/REQ/RER/RES/REU Radios Only) . . . . .267
  - System Activation . . . . .267
  - Electronic Serial Number/Sirius Identification Number (ESN/SID) . . . . .267
  - Selecting Satellite Mode . . . . .268
  - Satellite Antenna . . . . .268
  - Reception Quality . . . . .268

- Operating Instructions - Satellite Mode . . . . .269
- Operating Instructions - Hands-Free Phone (If Equipped) . . . . .271
- Operating Instructions - Video Entertainment System (VES®) (If Equipped) . . . . .271
- Video Entertainment System — If Equipped . . . . .272
- Universal Consumer Interface (UCI) — If Equipped . . . . .273
  - Connecting The iPod® Device . . . . .274
  - Controlling The iPod® Using Radio Buttons . . .274
  - Play Mode . . . . .274
  - List Or Browse Mode . . . . .276
- Remote Sound System Controls — If Equipped . .278
  - Right-Hand Switch Functions . . . . .278

- Left-Hand Switch Functions For Radio Operation . . . . .278
- Left-Hand Switch Functions For Media (i.e., CD) Operation . . . . .279
- CD/DVD Maintenance . . . . .279
- Radio Operation And Cellular Phones . . . . .280
- Climate Controls . . . . .280
  - General Climate Control Functions — All Systems . . . . .281
  - Single-Zone Manual Air Conditioning And Heating System . . . . .284
  - Two- And Three-Zone Manual Air Conditioning And Heating Systems — If Equipped . . . . .285
  - Two- And Three-Zone Automatic Temperature Control (ATC) Systems — If Equipped . . . . .289
  - Operating Tips . . . . .296

## INSTRUMENT PANEL FEATURES

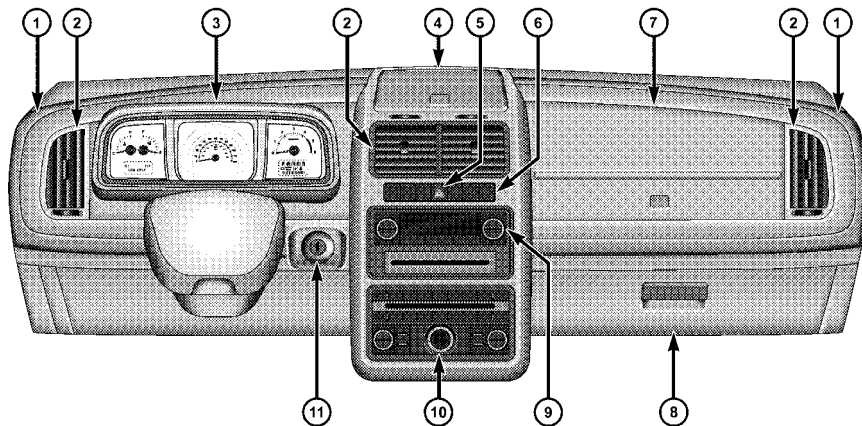

81d40f4b

1 — Side Window Demist Outlet

2 — Air Outlet

3 — Instrument Cluster

4 — Storage Compartment or Remote Display Panel\*

5 — HAZARD Switch

6 — Switch Bank

7 — Beverage Cooler/Storage Compartment\*

8 — Glove Box

9 — Climate Control

10 — Radio

11 — Ignition Switch

\* If Equipped

## INSTRUMENT CLUSTER

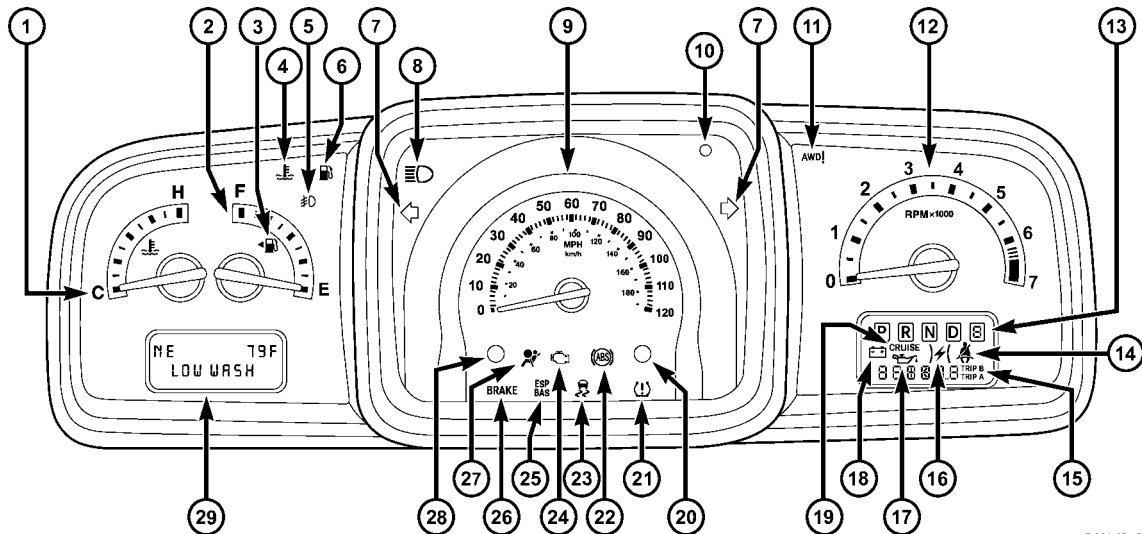

## INSTRUMENT CLUSTER DESCRIPTIONS

### 1. *Coolant Temperature Gauge*

The temperature gauge indicates engine coolant temperature. Any reading within the normal range indicates that the cooling system is operating satisfactorily. The gauge pointer will likely indicate a high temperature when driving in hot weather, up mountain grades, in heavy traffic, or when towing a trailer. If the pointer rises to the “H” mark, safely pull over and stop the vehicle. If the Air Conditioning A/C system is on, turn it off. Also, shift the transaxle into NEUTRAL and idle the vehicle. If the needle remains on the “H” mark, turn the engine OFF immediately and call for service. (See page 390 for more information.)

**NOTE:** The gauge pointer will remain near its last reading when the engine is turned off. It will return to a true reading when the engine is restarted.

## CAUTION!

**Do not leave your vehicle unattended with the engine running, as you would not be able to react to the temperature indicator light if the engine overheats.**

4

### 2. *Fuel Gauge*

The fuel gauge shows the level of fuel in the tank when ignition switch is in the ON position.

### 3. *Fuel Cap Indicator*



This symbol indicates the side of the vehicle where the fuel filler cap is located.

### 4. *Coolant Temperature Warning Light*



This light warns of an overheated engine condition. If the light turns on while driving, safely pull over and stop the vehicle. If the A/C system is on,

turn it off. Also, shift the transaxle into NEUTRAL and idle the vehicle. If the temperature reading does not return to normal, turn the engine off immediately and call for service. (See page 390 for more information.)

**NOTE:** As the coolant temperature gauge approaches "H," this indicator will illuminate and a single chime will sound. Further overheating will cause the temperature gauge to pass "H." In this case, the indicator light will flash continuously and a continuous chime will sound, until the engine is allowed to cool.

### CAUTION!

**Driving with a hot cooling system could damage your vehicle. If the temperature gauge reads "H," safely pull over and stop the vehicle. Idle the vehicle with the A/C turned off until the pointer drops back into the normal range. If the pointer remains on the "H," and you hear continuous chimes, turn the engine OFF immediately, and call for service.**

**WARNING!**

A hot engine cooling system is dangerous. You or others could be badly burned by steam or boiling coolant. You may want to call a service center if your vehicle overheats. If you decide to look under the hood yourself, refer to Section 7 and follow the warnings under the Cooling System Pressure Cap paragraph.

**5. Front Fog Light Indicator Light — If Equipped**

 This light shows when the fog lights are ON. (See page 146 for more information.)

**6. Low Fuel Warning Light**

 This indicator lights when the fuel level drops to approximately one-eighth tank. (See page 367 for more information.)

**7. Turn Signal Indicator Light**

 The left or right arrow will flash in unison with the corresponding front and rear turn signal lights when the turn signal switch is operated. (See page 147 for more information.)

**NOTE:** A chime will sound if the vehicle is driven more than 1 mi (1.6 km) with either turn signal on.

**NOTE:** Check for an inoperative outside light bulb if either indicator flashes at a rapid rate.

**8. High Beam Indicator Light**

 This light shows that the headlights are on high beam. Pull the multifunction lever on the left side of the steering column toward you to switch to low beam. (See page 148 for more information.)

**9. Speedometer**

Shows the vehicle speed.

### **10. Vehicle Security Alarm (VSA) Indicator Light — If Equipped**

 This light will flash rapidly for approximately 16 seconds when the vehicle Security system is arming and then flash slowly when the system is armed. The light will also turn on for about three seconds when the ignition switch is first turned ON. (See page 18 for more information.)

### **11. All-Wheel Drive (AWD) Failure Indicator Light — If Equipped**

**AWD!** This light monitors the All-Wheel-Drive (AWD) system. The light will turn on for a bulb check when the ignition switch is turned to the ON position and may stay on for as long as three seconds.

**When lit solid:** There is an AWD system fault. AWD performance will be at a reduced level. Service the AWD system soon.

**When blinking:** The AWD system is temporarily disabled due to overload condition.

### **12. Tachometer**

This gauge measures engine revolutions per minute (RPM x 1000). Before the pointer reaches the red area, ease up on the accelerator to prevent engine damage.

### **13. Transaxle Range Indicator**

This display indicator shows automatic transaxle gear selection. (See page 306 for more information.)

### **14. Seat Belt Reminder Light**

 This light will turn on for several seconds after the ignition switch is turned ON as a reminder to “buckle up.” This light will remain on as long as the driver’s seat belt remains unbuckled. (See page 46 for more information.)



### **15. Odometer/Trip Odometer**

The odometer shows the total distance the vehicle has been driven. The trip odometer shows individual trip mileage. Refer to “Trip Odometer button” for additional information.

**NOTE:** U.S. Federal regulations require upon transfer of vehicle ownership, the seller certify the mileage the vehicle has been driven. Therefore, if the odometer reading is changed because of repair or replacement, be sure to keep a record of the reading before and after the service so that the correct mileage can be determined.

### **Vehicle Warning Messages**

When the appropriate conditions exist, messages such as “hood” (hood ajar), “door” (door ajar), “gATE” (liftgate ajar), “LoCOOL” (low engine coolant), “LoWASH” (low washer fluid), “gASCAP” (fuel cap fault), “ESPOFF”

(ESP in partial off mode), “NoFUSE” (IOD fuse out), “HotOIL” (2.4L engine oil temp too hot), or “CHANgE OIL” will display in the odometer.

**NOTE:** If the instrument cluster is equipped with the optional Electronic Vehicle Information Center (EVIC), then most warnings will display in the EVIC. (See page 218 for more information.)

### **Hot Oil — 2.4L Engine**

Refer to “Engine Oil Overheating — 2.4L Engine Only” under “If Your Engine Overheats” in Section 6.

### **Fuel Cap Fault Message**

If the vehicle diagnostic system determines that the fuel filler cap is loose, improperly installed, or damaged, the word “gASCAP” will display in the odometer. If this occurs, tighten the fuel filler cap until a “clicking” sound is heard. Then press the TRIP ODOMETER button to turn

off the message. If the problem persists, the message will appear the next time the vehicle is started.

A loose, improperly installed, or damaged fuel filler cap may also turn on the MIL. (See page 419 for more information.)

### ***Change Oil Message (Base And Mid Line Clusters Only)***

Your vehicle is equipped with an engine oil change indicator system. The “CHANgE OIL” message will flash in the instrument cluster odometer for approximately 12 seconds after a single chime has sounded to indicate the next scheduled oil change interval. The engine oil change indicator system is duty cycle based, which means the engine oil change interval may fluctuate dependent upon your personal driving style.

Unless reset, this message will continue to display each time you turn the ignition switch to the ON position. To turn off the message temporarily, press and release the TRIP ODOMETER button on the instrument cluster. To reset the oil change indicator system (after performing the scheduled maintenance) perform the following procedure:

1. Turn the ignition switch to the ON position. (Do not start the engine).
2. Fully depress the accelerator pedal slowly three times within 10 seconds.
3. Turn the ignition switch to the LOCK position.

**NOTE:** If the indicator message illuminates when you start the vehicle, the oil change indicator system did not reset. If necessary, repeat this procedure.

### 16. *Electronic Throttle Control (ETC) Warning Light — If Equipped*



This light will turn on briefly as a bulb check when the ignition switch is turned ON. This light will also turn on while the engine is running if there is a problem with the Electronic Throttle Control (ETC) system.

If the light turns on while the engine is running, safely bring the vehicle to a complete stop as soon as possible, place the shift lever in PARK, and cycle the ignition key. The light should turn off. If the light remains lit with the engine running, your vehicle will usually be drivable. However, see your authorized dealer for service as soon as possible.

If the light is flashing when the engine is running, immediate service is required. In this case, you may experience reduced performance, an elevated/rough idle or engine stall, and your vehicle may require towing.

Also, have the system checked by an authorized dealer if the light does not turn on during starting.

### 17. *Oil Pressure Warning Light*



This light shows low engine oil pressure. The light will turn on and remain on when the ignition switch is turned from the LOCK or ACC position to the ON position. The light will turn off after the engine is started.

If the light does not turn on during starting, have the system checked by an authorized dealer.

If the light turns on and remains on while driving, safely bring the vehicle to a stop and shut off the engine. **DO NOT OPERATE THE VEHICLE UNTIL THE CAUSE IS CORRECTED.** This light does not show the quantity of oil in the engine. The engine oil level must be checked using the proper procedure. (See page 422 for more information.)

### 18. Charging System Warning Light

 This light shows the status of the electrical charging system. The light should turn on when the ignition switch is first turned ON and remain on briefly as a bulb check. If the light stays on or turns on while driving, turn off some of the vehicle's electrical devices, such as the fog lights or rear defroster. If the light remains on, it means that the charging system is experiencing a problem. See your local authorized dealer to obtain service immediately.

### 19. Cruise Indicator Light — If Equipped

**CRUISE** This indicator lights when the electronic speed control system is turned on. (See page 157 for more information.)

### 20. Trip Odometer Button

#### *Changing the Display*

Press and release this button once to change the display from odometer to “Trip A.” Press and release it again to change the display from “Trip A” to “Trip B.”

### *Resetting the Trip Odometer*

Display the trip mileage that you want to reset, “Trip A” or “Trip B.” Then push and hold the button (approximately two seconds) until the display resets to 0. The odometer must be in Trip Mode to reset the trip odometer.

### 21. Tire Pressure Monitoring Telltale Light — If Equipped

 Each tire, including the spare (if provided), should be checked monthly when cold and inflated to the inflation pressure recommended by the vehicle manufacturer on the vehicle placard or tire inflation pressure label. (If your vehicle has tires of a different size than the size indicated on the vehicle placard or tire inflation pressure label, you should determine the proper tire inflation pressure for those tires.)

As an added safety feature, your vehicle has been equipped with a tire pressure monitoring system (TPMS) that illuminates a low tire pressure telltale when one or more of your tires is significantly under-inflated. Accordingly, when the low tire pressure telltale light illuminates, you should stop and check your tires as soon as possible, and inflate them to the proper pressure. Driving on a significantly under-inflated tire causes the tire to over-heat and can lead to tire failure. Under-inflation also reduces fuel efficiency and tire tread life, and may affect the vehicle's handling and stopping ability.

Please note that the TPMS is not a substitute for proper tire maintenance, and it is the driver's responsibility to maintain correct tire pressure, even if under-inflation has not reached the level to trigger illumination of the TPMS low tire pressure telltale.

Your vehicle has also been equipped with a TPMS malfunction indicator to indicate when the system is not

operating properly. The TPMS malfunction indicator is combined with the low tire pressure telltale. When the system detects a malfunction, the telltale will flash for approximately one minute and then remain continuously illuminated. This sequence will continue upon subsequent vehicle start-ups as long as the malfunction exists. When the malfunction indicator is illuminated, the system may not be able to detect or signal low tire pressure as intended. TPMS malfunctions may occur for a variety of reasons, including the installation of replacement or alternate tires or wheels on the vehicle that prevent the TPMS from functioning properly. Always check the TPMS malfunction telltale light after replacing one or more tires or wheels on your vehicle to ensure that the replacement or alternate tires and wheels allow the TPMS to continue to function properly. (See page 350 for more information.)

**CAUTION!**

The TPMS has been optimized for the original equipment tires and wheels. TPMS pressures and warning have been established for the tire size equipped on your vehicle. Undesirable system operation or sensor damage may result when using replacement equipment that is not of the same size, type, and/or style. Aftermarket wheels can cause sensor damage. Do not use aftermarket tire sealants or balance beads if your vehicle is equipped with a TPMS, as damage to the sensors may result. (Refer to “Tire Inflation Pressures” under “Tires — General Information” and to “Tire Pressure Monitor System (TPMS)” in Section 5 for more information).

**22. Anti-Lock Brake System (ABS) Warning Light**

This light monitors the Anti-Lock Brake System (ABS). The light will turn on when the ignition switch is turned to the ON position and may stay on for as long as four seconds.

If the ABS light remains on or turns on while driving, it indicates that the Anti-Lock portion of the brake system is not functioning and that service is required. However, the conventional brake system will continue to operate normally if the Brake System Warning Light is not on.

If the ABS light is on, the brake system should be serviced as soon as possible to restore the benefit of Anti-Lock brakes. Furthermore, the ABS light should be checked frequently to assure that it is operating properly. If the light does not turn on, have the system checked by an authorized dealer. (See page 323 for more information.)

### 23. *Electronic Stability Program (ESP)/Traction Control System (TCS) Indicator Light*



If this indicator light flashes during acceleration, ease up on the accelerator and apply as little throttle as possible. Adapt your speed and driving to the prevailing road conditions. (See page 323 for more information.)

### 24. *Malfunction Indicator Light (MIL)*



This light is part of an Onboard Diagnostic system called OBD II. The OBD system monitors emissions, engine, and automatic transaxle control systems. The MIL will turn on when the key is in the ON position before engine start. If the MIL does not turn on when turning the key from LOCK or ACC to ON, have the condition checked promptly.

Certain conditions such as a loose or missing gas cap, poor fuel quality, etc., may illuminate the MIL after engine start. The vehicle should be serviced if the MIL

stays on through several of your typical driving cycles. In most situations, the vehicle will drive normally and will not require towing.

If the MIL flashes when the engine is running, serious conditions may exist that could lead to immediate loss of power or severe catalytic converter damage. (See page 419 for more information.)

#### **CAUTION!**

**Prolonged driving with the MIL on could cause further damage to the emissions control system. It could also affect fuel economy and driveability. The vehicle must be serviced before any emissions tests can be performed.**

**If the MIL is flashing while the engine is running, severe catalytic converter damage and power loss will soon occur. Immediate service is required.**

### **25. Electronic Stability Program (ESP)/Brake Assist System (BAS) Malfunction Indicator Light – If Equipped**

**ESP  
BAS** The yellow ESP/BAS Malfunction Indicator Light will turn on when the ignition switch is turned to the ON position. The light should go out with the engine running. The system will turn the light on continuously while the engine is running if it detects a malfunction in either the ESP or the BAS or both. If this light remains on after the several ignition cycles, and the vehicle has been driven several miles (kilometers) at speeds greater than 30 mph (48 km/h), see your authorized dealer as soon as possible to have the problem diagnosed and corrected. (See page 323 for more information.)

### **26. Brake System Warning Light**

**BRAKE** This light monitors various brake functions, including brake fluid level and parking brake application. If the light turns on, it may indicate that the parking brake is applied, that the brake fluid level is low, or that there is a problem with the ABS.

The dual brake system provides a reserve braking capacity to a portion of the hydraulic system in the event of a failure. Failure of either half of the dual brake system is indicated by the Brake System Warning Light, which will turn on when the brake fluid level in the master cylinder drops below a specified level.

The light will remain on until the cause is corrected.



**NOTE:** The light may flash momentarily during sharp cornering maneuvers due to a change in fluid level. If so, the vehicle should have service performed and the brake fluid level checked.

Immediate repair is necessary if brake failure is indicated.

### **WARNING!**

**Driving a vehicle with the Brake System Warning Light on is dangerous. A significant decrease in braking performance or vehicle stability during braking may occur. It will take you longer to stop the vehicle or will make your vehicle harder to control. You could have an accident. Have the vehicle checked immediately.**

Vehicles equipped with ABS are also equipped with Electronic Brake Force Distribution (EBD). Both the Brake

Warning Light and the ABS Light will turn on in the event of an EBD failure. Immediate repair of the ABS is required in the event of an EBD failure.

The operation of the Brake Warning Light can be checked by turning the ignition switch from the LOCK position to the ON position. The light should turn on for approximately two seconds and then turn off. The light will remain on if the parking brake is applied or if a brake fault is detected. If the parking brake is not applied and the light remains on, or if the light does not turn on, have the light inspected by an authorized dealer.

**NOTE:** The light will turn on when the ignition switch is in the ON position and the parking brake is applied. This light shows only that the parking brake is applied. It does not show the degree of brake application. (See page 321 for more information.)

### **27. Airbag Warning Light**



This light will turn on for four to six seconds as a bulb check when the ignition switch is first turned ON. If the light is either not on during starting, or stays on, or turns on while driving, then have the system inspected at your authorized dealer as soon as possible. (See page 61 for more information.)

### **28. Compass/Temperature Display Button (Mid Line Clusters Only)**

Operates the Compass/Temperature display in the Vacuum Fluorescent Display.

### **29. Vacuum Fluorescent Display (Mid Line And Premium Clusters Only)**

On vehicles equipped with a Premium Cluster, this display shows the Electronic Vehicle Information Center (EVIC) messages when the appropriate conditions exist. (See page 218 for more information.)

On vehicles equipped with a Mid Line Cluster, this display shows the compass heading (N, S, E, W, NE, NW, SE, and SW) and the outside temperature. The COMPASS/TEMPERATURE DISPLAY button operates this display. Press and release the button once to turn on the display. Press and release it again to turn off the display.

### **Setting Compass Variance (Mid Line Cluster Only)**

Compass Variance is the difference between magnetic North and geographic North. To allow the compass module to compensate for that difference and ensure accuracy, you can set the variance in the compass module to the zone where the vehicle is located according to the Compass Variance Map. To set the variance, perform the following procedure.

**NOTE:**

- Magnetic materials should be kept away from the top of the instrument panel, as this is where the compass sensor is located.
- The shift lever must be in PARK to enter the variance setting mode.

To set the variance, first, turn the ignition switch to the ON position. Next, press and hold the COMPASS/TEMPERATURE DISPLAY button until the current variance zone number displays (approximately 10 seconds). Then, press and release the button to increment the variance value by one, until the proper variance zone is selected according to the map. Finally, turn the ignition switch to the LOCK position to exit this mode.

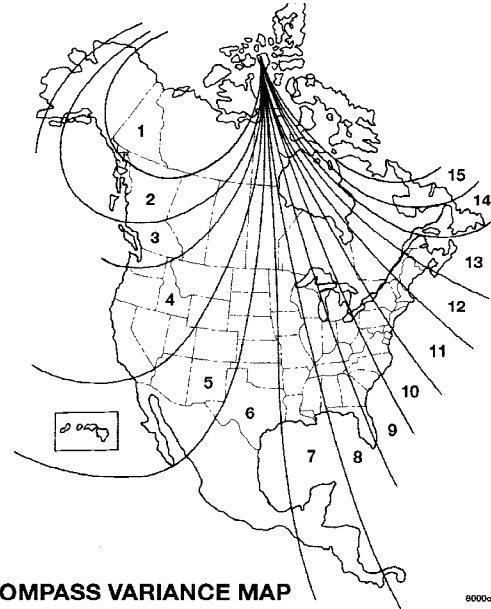

**NOTE:** The default variance setting is Zone 8. When setting the variance, the numbering will wrap around from Zone 15 to Zone 1.

### ***Calibrating the Compass (Mid Line Cluster Only)***

If the compass appears erratic, inaccurate, or abnormal, you may wish to calibrate it. However, prior to calibrating the compass, make sure the proper Compass Variance value is selected.

**NOTE:** The shift lever must be in PARK to enter the Calibration mode.

To calibrate the compass, first, start the engine. Next, press and hold the COMPASS/TEMPERATURE DISPLAY button until the current variance zone number displays (approximately 10 seconds). Then, press and hold the button again until the direction displays with the “CAL” indicator on continuously (approximately 10

seconds). Finally, drive the vehicle in one or more complete circles, at speeds under 5 mph (8 km/h), in an area free from power lines and large metallic objects, until the “CAL” indicator turns off. The compass will now function normally.

### **ELECTRONIC VEHICLE INFORMATION CENTER (EVIC) — IF EQUIPPED**

The Electronic Vehicle Information Center (EVIC) features a driver-interactive display. It is located in the instrument cluster below the fuel and temperature gauges. Vehicles equipped with steering wheel-mounted buttons (described in this section) are also equipped with the EVIC. The EVIC consists of the following:

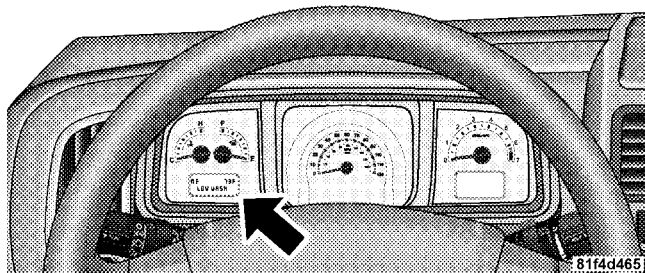

EVIC

- Compass display,
- Outside temperature display,
- Trip computer functions,
- System status, including vehicle information warning message displays, and Tire Pressure Monitor System (TPMS) displays (if equipped), and,
- Personal Settings (customer programmable features).

The system allows the driver to select information by pressing the following buttons mounted on the steering wheel.

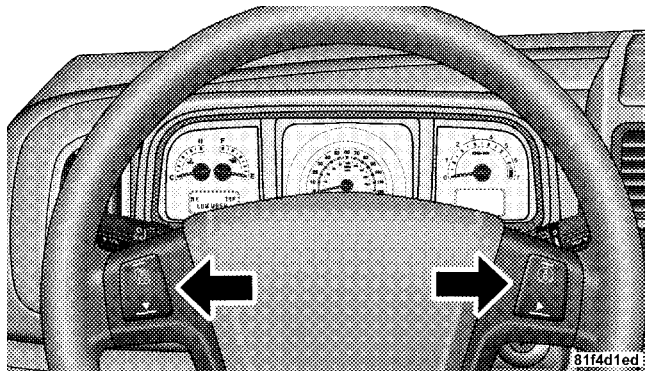

**EVIC Steering Wheel Switches**



**MENU  
Button**

Press and release this button and the mode displayed will change between Compass/ Outside Temperature, Trip Functions, System Status, and Personal Settings.



**RESET  
Button**

Press this button to reset Trip Functions and change Personal Settings.



**SCROLL  
Button**

Press this button to scroll through Trip Functions (Average Fuel Economy, Distance To Empty [DTE], Elapsed Time, Units In), System Status Messages, and Personal Settings (Customer Programmable Features).



Press this button to display the Compass/Outside Temperature.

**COMPASS/  
TEMPERA-  
TURE Button**

**Electronic Vehicle Information Center (EVIC)  
Displays**

When the appropriate conditions exist, the EVIC displays the following messages:

- Turn Signal On (with a continuous warning chime if the vehicle is driven more than 1 mi [1.6 km] with either turn signal on)
- Left Front Turn Signal Light Out (with a single chime)
- Left Rear Turn Signal Light Out (with a single chime)
- Right Front Turn Signal Light Out (with a single chime)
- Right Rear Turn Signal Light Out (with a single chime)
- RKE Battery Low (with a single chime)
- Personal Settings Not Available – Vehicle Not in PARK
- Channel # Transmit. Refer to “Garage Door Opener” in Section 2.
- Channel # Training. Refer to “Garage Door Opener” in Section 2.
- Channel # Trained. Refer to “Garage Door Opener” in Section 2.
- Clearing Channels. Refer to “Garage Door Opener” in Section 2.
- Channels Cleared. Refer to “Garage Door Opener” in Section 2.
- Did Not Train. Refer to “Garage Door Opener” in Section 2.

- Left Front Low Pressure (with a single chime). Refer to information on “Tire Pressure” and “Tire Pressure Monitor” in Section 5.
- Left Rear Low Pressure (with a single chime). Refer to information on “Tire Pressure” and “Tire Pressure Monitor” in Section 5.
- Right Front Low Pressure (with a single chime). Refer to information on “Tire Pressure” and “Tire Pressure Monitor” in Section 5.
- Right Rear Low Pressure (with a single chime). Refer to information on “Tire Pressure” and “Tire Pressure Monitor” in Section 5.
- Check TPM System (with a single chime). Refer to information on “Tire Pressure Monitor” in Section 5.
- Low Fuel
- Cal

- Oil Change Required (with a single chime)
- Low Washer Fluid
- Coolant Low
- Key in Ignition
- Lights On

### **Oil Change Required**

Your vehicle is equipped with an engine oil change indicator system. The “Oil Change Required” message will display in the EVIC for approximately 5 seconds after a single chime has sounded to indicate the next scheduled oil change interval. The engine oil change indicator system is duty cycle based, which means the engine oil change interval may fluctuate dependent upon your personal driving style.

Unless reset, this message will continue to display each time you turn the ignition switch to the ON position. To



turn off the message temporarily, press and release the MENU button. To reset the oil change indicator system (after performing the scheduled maintenance) perform the following procedure:

1. Turn the ignition switch to the ON position (Do not start the engine).
2. Fully depress the accelerator pedal slowly three times within 10 seconds.
3. Turn the ignition switch to the LOCK position.

**NOTE:** If the indicator message illuminates when you start the vehicle, the oil change indicator system did not reset. If necessary, repeat this procedure.

### **Trip Functions**

Press and release the MENU button until one of the following Trip Functions displays in the EVIC:

- Average Fuel Economy
- Distance To Empty
- Elapsed Time
- Units In

Press the SCROLL button to cycle through all the Trip Computer functions.

The Trip Functions mode displays the following information.

- ***Average Fuel Economy***

Shows the average fuel economy since the last reset. When the fuel economy is reset, the display will read "RESET" or show dashes for two seconds. Then, the history information will be erased, and the averaging will continue from the last fuel average reading before the reset.

- ***Distance To Empty (DTE)***

Shows the estimated distance that can be traveled with the fuel remaining in the tank. This estimated distance is determined by a weighted average of the instantaneous and average fuel economy, according to the current fuel tank level. DTE cannot be reset through the RESET button.

**NOTE:** Significant changes in driving style or vehicle loading will greatly affect the actual drivable distance of the vehicle, regardless of the DTE displayed value.

- When the DTE value is less than 30 mi (48 km) estimated driving distance, the DTE display will change to a text display of "LOW FUEL." This display will continue until the vehicle runs out of fuel. Adding a significant amount of fuel to the vehicle will turn off the "LOW FUEL" text and a new DTE value will display.

- ***Elapsed Time***

Shows the total elapsed time of travel since the last reset when the ignition switch is in the ACC position. Elapsed time will increment when the ignition switch is in the ON or START position.

- **Units In**

The EVIC, odometer, and navigation system (if equipped) can be changed between English and Metric units of measure. To make your selection, press and release the RESET button until “U.S.” or “METRIC” appears.

### **To Reset The Display**

Reset will only occur while a resettable function is being displayed. Press and release the RESET button once to clear the resettable function being displayed. To reset all resettable functions, press and release the RESET button a second time within three seconds of resetting the currently-displayed function. (>Reset ALL will display during this three-second window).

### **Compass Display**



**COMPASS/  
TEMPERA-  
TURE Button**

Press and release this button to display one of eight compass readings and the outside temperature. The compass readings indicate the direction the vehicle is facing.

### **Automatic Compass Calibration**

This compass is self-calibrating, which eliminates the need to calibrate the compass manually. When the vehicle is new, the compass may appear erratic and the EVIC will display “CAL” until the compass is calibrated. You may calibrate the compass by slowly completing one or more 360-degree turns (in an area free from large metal or metallic objects) until the “CAL” message displayed in the EVIC turns off. The compass will now function normally.

### Manual Compass Calibration

If the compass appears erratic or is inaccurate, you can calibrate the compass manually by performing the following steps.

1. Turn the ignition switch ON.
2. Press and release the MENU button until Personal Settings displays in the EVIC.
3. Press the SCROLL button until “CALIBRATE COMPASS” displays in the EVIC.
4. Press and release the RESET button to start the calibration. The message “CAL” will display in the EVIC.
5. Slowly complete one or more 360-degree turns (in an area free from large metal or metallic objects) until the “CAL” message turns off. The compass will now function normally.

### Compass Variance

Compass Variance is the difference between magnetic North and geographic North. To allow the compass module to compensate for that difference and ensure accuracy, you can set the variance in the compass module to the zone where the vehicle is located according to the Compass Variance Map. To set the variance, perform the following steps.

#### NOTE:

- The default variance setting is Zone 8. When setting the variance, the numbering will wrap around from Zone 15 to Zone 1.
- Magnetic materials should be kept away from the top of the instrument panel, as this is where the compass sensor is located.

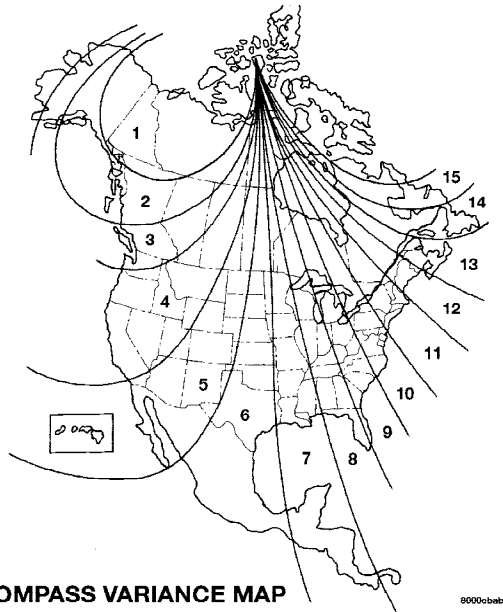

**COMPASS VARIANCE MAP**

8000bab

1. Turn the ignition switch ON.
2. Press and release the MENU button until Personal Settings displays in the EVIC.
3. Press the SCROLL button until “COMPASS VARIANCE” message and the last variance zone number displays in the EVIC.
4. Press and release RESET button until the proper variance zone is selected according to the map.
5. Press and release the COMPASS/TEMPERATURE button to exit.

4

### **Personal Settings (Customer Programmable Features)**

Personal Settings allows the driver to set and recall features when the transaxle is in PARK.

Press and release the MENU button until Personal Settings displays in the EVIC.

Use the SCROLL button to display one of the following choices.

### **“LANGUAGE”**

When in this display you may select one of three languages for all display nomenclature, including the trip functions and the navigation system (if equipped). Press the RESET button while in this display to select English, French, or Spanish. Then, as you continue, the information will display in the selected language.

**NOTE:** The EVIC will not change the UConnect® language selection. Refer to “Language Selection” under “Hands-Free Communication (UConnect®)” in Section 3.

### **“AUTO UNLK ON EXIT”**

When ON is selected, all doors and the liftgate will unlock when the vehicle is stopped and the transaxle is in the PARK or NEUTRAL position and the driver’s door is opened. To make your selection, press and release the RESET button until “ON” or “OFF” appears.

### **“RKE UNLOCK”**

When **Driver Door 1st Press** is selected, only the driver’s door will unlock on the first press of the Remote Keyless Entry (RKE) UNLOCK button. When **Driver Door 1st Press** is selected, you must press the RKE UNLOCK button twice to unlock the passenger doors and liftgate. When **All Doors 1st Press** is selected, all doors and the liftgate will unlock on the first press of the RKE UNLOCK button. To make your selection, press and release the RESET button until “Driver Door 1st Press” or “All Doors 1st Press” appears.

### **“SOUND HORN WITH LOCK”**

When ON is selected, a short horn sound will occur when the RKE LOCK button is pressed. This feature may be selected with or without the flash lights with lock feature. To make your selection, press and release the RESET button until “ON” or “OFF” appears.

**“FLASH LAMP WITH LOCK”**

When ON is selected, the front and rear turn signals will flash when the doors are locked or unlocked with the RKE transmitter. This feature may be selected with or without the sound horn on lock feature selected. To make your selection, press and release the RESET button until “ON” or “OFF” appears.

**“HEADLAMP OFF DELAY”**

When this feature is selected, the driver can choose to have the headlights remain on for 0, 30, 60, or 90 seconds after turning the ignition to the LOCK position. To make your selection, press and release the RESET button until “0,” “30,” “60,” or “90” appears.

**“HEADLAMPS WITH WIPERS” (Available with Auto Headlights Only)**

When ON is selected, and the multifunction lever is placed in the AUTO position, the headlights will turn on approximately 10 seconds after the wipers are turned

ON. The headlights will also turn off when the wipers are turned OFF if they were turned ON by this feature. To make your selection, press and release the RESET button until “ON” or “OFF” appears.

**“KEY-OFF POWER DELAY”**

When this feature is selected, the power window switches, radio, hands-free system (if equipped), DVD video system (if equipped), power sunroof (if equipped), and ignition powered outlets will remain active for up to 10 minutes after the ignition switch is turned OFF. Opening a vehicle door will cancel this feature. To make your selection, press and release the RESET button until “Off,” “45 sec.,” “5 min.,” or “10 min.” appears.

**“ILLUMIN APPROACH”**

When this feature is selected, the headlights will activate and remain on for up to 90 seconds when the doors are

unlocked with the RKE transmitter. To make your selection, press and hold the RESET button until “Off,” “30 sec,” “60 sec,” or “90 sec” appears.

#### **“DISPLAY UNITS IN”**

The EVIC, odometer, and navigation system (if equipped) can be changed between English and Metric units of measure. To make your selection, press and release the RESET button until “U.S.” or “METRIC” appears.

#### **“NAV TURN BY TURN” — If Equipped**

When ON is selected, the Turn-by-Turn directions will appear in the display as the vehicle approaches a designated turn within a programmed route. To make your selection, press and release the RESET button until “ON” or “OFF” appears.

#### **COMPASS VARIANCE**

Refer to “Compass Variance” under “Compass Display.”

#### **CALIBRATE COMPASS**

Refer to “Manual Compass Calibration” under “Compass Display.”

#### **RADIO GENERAL INFORMATION**

##### **Radio Broadcast Signals**

The radio will provide excellent reception under most operating conditions. Like any system, however, car radios have performance limitations, due to mobile operation and natural phenomena, which might lead you to believe your sound system is malfunctioning. To help you understand and save you concern about these “apparent” malfunctions, you must understand a point or two about the transmission and reception of radio signals.



## Two Types of Signals

There are two basic types of radio signals: AM (Amplitude Modulation), in which the transmitted sound causes the amplitude, or height, of the radio waves to vary; and FM (Frequency Modulation), in which the frequency of the wave is varied to carry the sound.

## Electrical Disturbance

Radio waves may pick up electrical disturbances during transmission. They mainly affect the wave amplitude, and thus remain a part of the AM reception. They interfere very little with the frequency variations that carry the FM signal.

## AM Reception

AM sound is based on wave amplitude, so AM reception can be disrupted by such things as lightning, power lines and neon signs.

## FM Reception

Because FM transmission is based on frequency variations, interference that consists of amplitude variations can be filtered out, leaving the reception relatively clear, which is the major feature of FM radio.

### NOTE:

- For vehicles not equipped with the Electronic Vehicle Information Center (EVIC), the radio and steering wheel radio controls (if equipped) will remain active for 45 seconds after the ignition switch is turned to the LOCK position. Opening either front door will cancel this feature.
- For vehicles equipped with the EVIC, the radio and steering wheel radio controls (if equipped) will remain active for up to 10 minutes after the ignition switch is turned to the LOCK position. Opening either front door will cancel this feature. The time is programmable. For details, refer to “Key-Off Power Delay,”

under “Personal Settings (Customer Programmable Features)” under “Electronic Vehicle Information Center (EVIC)” in Section 4.

### **SALES CODE REN — MULTIMEDIA SYSTEM — IF EQUIPPED**

**NOTE:** The sales code is located on the lower right side of the unit’s faceplate.

The REN Multimedia system contains a radio, CD/DVD player, USB port, a 30-gigabyte hard drive (HDD), and a “JukeBox” (virtual CD changer). Sirius Satellite Radio is optional. The 6.5 in (16.5 cm) touch screen allows for easy menu selection.

A 30-gigabyte HDD allows uploads of music and photos from CDs or through the USB port. The Gracenote database finds the artist, track, and title for the music.

An auxiliary input jack permits passengers to listen to a portable MP3 player through the vehicle’s speakers. For

vehicles equipped with the Video Entertainment System (VES)<sup>®</sup>, separate audio outputs allow passengers to listen to the vehicle speakers while different audio tracks play through the system’s wireless headphones. This means rear-seat passengers can watch a DVD on the optional rear seat entertainment system, while the driver and front-seat passenger listen to the radio.

Other special features include direct tune, music type selections, easy store presets, backup camera display for vehicles equipped with a backup camera, and on some models, a dual display screen operation. Refer to your radio-specific user’s manual for detailed operating instructions.

### **Operating Instructions — Satellite Radio (If Equipped)**

Refer to your radio-specific user’s manual for detailed operating instructions.

### **Operating Instructions — Voice Recognition System (VR) (If Equipped)**

For the radio, refer to “Voice Recognition System (VR)” in Section 3.

For Hands Free Phone Communication (UConnect®) “Voice Recognition System (VR),” refer to “Hands-Free Communication (UConnect®)” in Section 3.

### **Operating Instructions — Hands-Free Communication (UConnect®) (If Equipped)**

Refer to “Hands-Free Communication (UConnect®)” in Section 3.

## **Clock Setting Procedure**

### **Setting the Clock**

1. Turn on the multimedia system.
2. Touch the screen where the time is displayed. The clock setting menu will appear on the screen.

3. To move the hour forward, touch the screen where the word “Hour” with the arrow pointing upward is displayed. To move the hour backward, touch the screen where the word “Hour” with the arrow pointing downward is displayed.

4. To move the minute forward, touch the screen where the word “Min” with the arrow pointing upward is displayed. To move the minute backward, touch the screen where the word “Min” with the arrow pointing downward is displayed.

5. To save the new time setting, touch the screen where the word “Save” is displayed.

### **Changing Daylight Savings Time**

When selected, this feature will display the time of day in daylight savings time. Proceed as follows to change the current setting:

1. Turn on the multimedia system.

2. Touch the screen where the time is displayed. The clock setting menu will appear on the screen.

3. When this feature is on, a check mark will appear in the box next to the words “Daylight Savings.” Touch the screen where the words “Daylight Savings” are displayed to change the current setting.

### **Show Time if Radio is Off**

When selected, this feature will display the time of day on the touch screen when the multimedia system is turned off. Proceed as follows to change the current setting:

1. Turn on the multimedia system.
2. Touch the screen where the time is displayed. The clock setting menu will appear on the screen.
3. When this feature is on, a check mark will appear in the box next to the words “Show Time if Radio is Off.”

Touch the screen where the words “Show Time if Radio is Off” are displayed to change the current setting.

### **Changing the Time Zone**

1. Turn on the multimedia system.
2. Touch the screen where the time is displayed. The clock setting menu will appear on the screen.
3. Touch the screen where the words “Set Time Zone” are displayed. The time zone selection menu will appear on the screen.
4. Select a time zone by touching the screen where your selection appears. If you do not see a time zone that you want to select, touch the screen where the word “Page” is displayed to view additional time zones in the menu.
5. Touch the screen where the word “Save” is displayed.

## SALES CODE REQ — AM/FM STEREO RADIO AND 6-DISC CD/DVD CHANGER (MP3/WMA AUX JACK)

**NOTE:** The radio sales code is located on the lower right side of your radio faceplate.

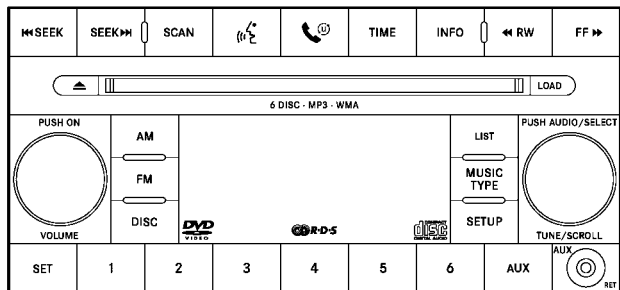

8189f8f9

### RET Radio

## Operating Instructions - Radio Mode

**NOTE:** The ignition switch must be in the ON or ACC position to operate the radio.

### Power Switch/Volume Control (Rotary)

Push the ON/VOLUME control knob to turn on the radio. Press the ON/VOLUME control knob a second time to turn off the radio.

### Electronic Volume Control

The electronic volume control turns continuously (360 degrees) in either direction without stopping. Turning the ON/VOLUME control knob to the right increases the volume and to the left decreases it.

When the audio system is turned ON, the sound will be set at the same volume level as last played.

### SEEK Buttons

Press and release the SEEK buttons to search for the next listenable station in AM/FM mode. Press the right switch

to seek up and the left switch to seek down. The radio will remain tuned to the new station until you make another selection. Holding either button will bypass stations without stopping until you release it.

### **SCAN Button**

Pressing the SCAN button causes the tuner to search for the next listenable station, in AM, FM or Satellite (if equipped) frequencies, pausing for five seconds at each listenable station before continuing to the next. To stop the search, press the SCAN button a second time.

### **Voice Recognition Button (UConnect® Hands-Free Phone) — If Equipped**

Press this button to operate the Hands-Free Phone (UConnect®) feature (if equipped). Refer to “Hands-Free Communication (UConnect®)” in Section 3.

If your vehicle is not equipped with or this feature is not available on your vehicle, a “Not Equipped With UConnect” message will display on the radio screen.

### **Phone Button (UConnect® Hands-Free Phone) — If Equipped**

Press this button to operate the Hands-Free Phone (UConnect®) feature (if equipped). Refer to “Hands-Free Communication (UConnect®)” in Section 3.

If your vehicle is not equipped with or this feature is not available on your vehicle, a “Not Equipped With UConnect” message will display on the radio screen.

### **TIME Button**

Press the TIME button and the time of day will display. In AM or FM mode, pressing the TIME button will switch between the time and frequency displays.

### **Clock Setting Procedure**

1. Press and hold the TIME button until the hours blink.
2. Adjust the hours by turning the right side TUNE/SCROLL control knob.

3. After adjusting the hours, press the right side TUNE/SCROLL control knob to set the minutes. The minutes will begin to blink.
4. Adjust the minutes using the right side TUNE/SCROLL control knob. Press the TUNE/SCROLL control knob to save the time change.
5. To exit, press any button/knob or wait five seconds.

The clock can also be set by pressing the SETUP button and selecting the “SET HOME CLOCK” entry. Once in this display follow the above procedure, starting at step 2.

### **INFO Button**

Press the INFO button for an RDS station (one with call letters displayed). The radio will return a Radio Text message broadcast from an FM station (FM mode only).

### **RW/FF**

Pressing the RW (Rewind) or FF (Fast Forward) buttons causes the tuner to search for the next frequency in the direction of the arrows. This feature operates in AM, FM or Satellite (if equipped) frequencies.

### **TUNE Control**

Turn the rotary TUNE/SCROLL control knob clockwise to increase or counterclockwise to decrease the frequency.

### **Setting the Tone, Balance, and Fade**

Push the rotary TUNE/SCROLL control knob and BASS will display. Turn the TUNE/SCROLL control knob to the right or left to increase or decrease the bass tones.

Push the rotary TUNE/SCROLL control knob a second time and MID will display. Turn the TUNE/SCROLL control knob to the right or left to increase or decrease the mid-range tones.

Push the rotary TUNE/SCROLL control knob a third time and TREBLE will display. Turn the TUNE/SCROLL control knob to the right or left to increase or decrease the treble tones.

Push the rotary TUNE/SCROLL control knob a fourth time and BALANCE will display. Turn the TUNE/SCROLL control knob to the right or left to adjust the sound level from the right or left side speakers.

Push the rotary TUNE/SCROLL control knob a fifth time and FADE will display. Turn the TUNE/SCROLL control knob to the left or right to adjust the sound level between the front and rear speakers.

Push the rotary TUNE/SCROLL control knob again to exit setting tone, balance, and fade.

### **MUSIC TYPE Button**

Pressing this button once will turn on the Music Type mode for five seconds. Pressing the MUSIC TYPE button

or turning the TUNE/SCROLL control knob within five seconds will allow the program format type to be selected. Many radio stations do not currently broadcast Music Type information.

Toggle the MUSIC TYPE button to select the following format types:

<b>Program Type</b>	<b>16-Digit Character Display</b>
No program type or undefined	None
Adult Hits	Adlt Hit
Classical	Classicl
Classic Rock	Cls Rock
College	College
Country	Country
Foreign Language	Language
Information	Inform
Jazz	Jazz



Program Type	16-Digit Character Display
News	News
Nostalgia	Nostalgia
Oldies	Oldies
Personality	Persnlty
Public	Public
Rhythm and Blues	R & B
Religious Music	Rel Musc
Religious Talk	Rel Talk
Rock	Rock
Soft	Soft
Soft Rock	Soft Rck
Soft Rhythm and Blues	Soft R & B
Sports	Sports
Talk	Talk
Top 40	Top 40
Weather	Weather

By pressing the SEEK button when the Music Type icon is displayed, the radio will be tuned to the next frequency station with the same selected Music Type name. The Music Type function only operates when in the FM mode.

If a preset button is activated while in the Music Type (Program Type) mode, the Music Type mode will be exited and the radio will tune to the preset station.

4

### SETUP Button

Pressing the SETUP button allows you to select between the following items:

**NOTE:** Turn the TUNE/SCROLL control knob to scroll through the entries. Push the AUDIO/SELECT button to select an entry and make changes.

- **DVD Enter** - When the disc is in DVD Menu mode, selecting DVD Enter will allow you to play the current highlighted selection. Use the remote control to scroll up and down the menu (if equipped).



- **DISC Play/Pause** - You can toggle between playing the DVD and pausing the DVD by pushing the SELECT button (if equipped).
- **DVD Play Options** - Selecting the DVD Play Options will display the following:
  - **Subtitle** – Repeatedly pressing SELECT will switch subtitles to different subtitle languages that are available on the disc (if equipped).
  - **Audio Stream** – Repeatedly pressing SELECT will switch to different audio languages (if supported on the disc) (if equipped).

- **Angle** – Repeatedly pressing SELECT will change the viewing angle if supported by the DVD disc (if equipped).

**NOTE:** The available selections for each of the above entries varies depending upon the disc.

**NOTE:** These selections can only be made while playing a DVD.

- **VES® Power** - Allows you to turn VES® ON and OFF (if equipped).
- **VES® Lock** - Locks out rear VES® remote controls (if equipped).
- **VES® CH1/CH2** - Allows the user to change the mode of either the IR1 or IR2, wireless headphones by pressing the AUDIO/SELECT button (if equipped).

- **Set Home Clock** - Pressing the SELECT button allows you to set the clock. Turn the TUNE/SCROLL control knob to adjust the hours and then press and turn the TUNE/SCROLL control knob to adjust the minutes. Press the TUNE/SCROLL control knob again to save changes.
- **Player Defaults** - Selecting this item will allow the user to scroll through the following items, and set defaults according to customer preference.

### ***Menu Language — If Equipped***

Selecting this item will allow the user to choose the default startup DVD menu language (effective only if language supported by disc). If you want to select a language not listed, then scroll down and select "other." Enter the four-digit country code using the TUNE/SCROLL control knob to scroll up and down to select the number and then push to select.

### ***Audio Language — If Equipped***

Selecting this item allows you to choose a default audio language (effective only if the language is supported by the disc). You can select a language not listed by scrolling down and selecting "other." Enter the country code using the TUNE/SCROLL control knob to scroll up and down to select the number and then push to select.

### ***Subtitle Language — If Equipped***

Selecting this item allows you to choose a default subtitle language (effective only if the language is supported by the disc). You can select a language not listed by scrolling down and selecting "other." Enter the country code using the TUNE/SCROLL control knob to scroll up and down to select the number and then push to select.

### ***Subtitles — If Equipped***

Selecting this item allows you to choose between subtitle Off or On.

***Audio DRC — If Equipped***

Selecting this item allows you to limit maximum audio dynamic range. The default is set to "High," and under this setting, dialogues will play at 11 db higher than if the setting is "Normal."

***Aspect Ratio — If Equipped***

Selecting this item allows you to choose between wide screen, pan scan, and letter box.

***AutoPlay — If Equipped***

When this is set to On and a DVD video is inserted, it will bypass the DVD menu screen and automatically play the movie. In some rare cases, the DVD player may not auto-play the main title. In such cases, use the MENU button on the remote control to select desired title to play.

**NOTE:** The user will have to set these defaults before loading a disc. If changes are made to these settings after

a disc is loaded, changes will not be effective. Also, the defaults are effective only if the disc supports the customer-preferred settings.

**AM and FM Buttons**

Press the buttons to select AM or FM Modes.

**SET Button — To Set the Pushbutton Memory**

When you are receiving a station that you wish to commit to pushbutton memory, press the SET button. The symbol SET 1 will now show in the display window. Select the button (1-6) you wish to lock onto this station and press and release that button. If a button is not selected within five seconds after pressing the SET button, the station will continue to play but will not be stored into pushbutton memory.

You may add a second station to each pushbutton by repeating the above procedure with this exception: Press the SET button twice and SET 2 will show in the display window. Each button can be set for SET 1 and SET 2 in

both AM and FM. This allows a total of 12 AM, 12 FM, and 12 Satellite (if equipped) stations to be stored into pushbutton memory. The stations stored in SET 2 memory can be selected by pressing the pushbutton twice.

Every time a preset button is used, a corresponding button number will display.

### **Buttons 1 - 6**

These buttons tune the radio to the stations that you commit to pushbutton memory {12 AM, 12 FM, and 12 Satellite (if equipped) stations}.

### **DISC Button**

Pressing the DISC button will allow you to switch from AM/FM modes to Disc modes.

### **Operation Instructions - (DISC MODE for CD and MP3/WMA Audio Play, DVD-VIDEO)**

The radio DVD player and many DVD discs are coded by geographic region. These region codes must match in order for the disc to play. If the region code for the DVD disc does not match the region code for the radio DVD player, it will not play the disc. Customers may take their vehicle to an authorized dealer to change the region code of the player a maximum of five times.

#### **CAUTION!**

**The radio may shut down during extremely hot conditions. When this occurs, the radio will indicate “Disc Hot” and shut off until a safe temperature is reached. This shutdown is necessary to protect the optics of the DVD player and other radio internal components.**

**NOTE:** The ignition switch must be in the ON or ACC position to operate the radio.

### **LOAD Button — Loading Compact Disc(s)**

Press the LOAD button and the pushbutton with the corresponding number (1-6) where the CD is being loaded. The radio will display PLEASE WAIT and prompt when to INSERT DISC. After the radio displays "INSERT DISC," insert the CD into the player.

Radio display will show "LOADING DISC" when the disc is loading and "READING DISC" when the radio is reading the disc.

### **CAUTION!**

**This CD player will accept 4-3/4 in (12 cm) discs only. The use of other sized discs may damage the CD player mechanism.**

### **Eject Button — Ejecting Compact Disc(s)**



Press the EJECT button and the pushbutton with the corresponding number (1-6) where the CD was loaded and the disc will unload and move to the entrance for easy removal. Radio display will show "EJECTING DISC" when the disc is being ejected and prompt the user to remove the disc.

Press and hold the EJECT button for five seconds and all CDs will be ejected from the radio.

The disc can be ejected with the radio and ignition OFF.

### **SEEK Button (CD MODE)**

Press the right SEEK button for the next selection on the CD. Press the left SEEK button to return to the beginning of the current selection, or return to the beginning of the previous selection if the CD is within the first second of the current selection. Pressing and holding the SEEK button will allow you to scroll through the tracks faster in CD, MP3/MWA modes.

**SCAN Button (CD MODE)**

Press the SCAN button to scan through each track on the CD currently playing.

**TIME Button (CD MODE)**

Press this button to change the display from a large CD playing time display to a small CD playing time display.

**RW/FF (CD MODE)**

Press and hold FF (Fast Forward) and the CD player will begin to fast forward until FF is released, or RW or another CD button is pressed. The RW (Rewind) button works in a similar manner.

**AM or FM Button (CD MODE)**

Switches the radio to the Radio mode.

**Notes On Playing MP3/WMA Files**

The radio can play MP3/WMA files; however, acceptable MP3/WMA file recording media and formats are limited. When writing MP3/WMA files, pay attention to the following restrictions.

**Supported Media (Disc Types)**

The MP3/WMA file recording media supported by the radio are CDDA, CD-R, CD-RW, MP3, WMA, DVD Video, DVD-R, DVD-RW, DVD+R, DVD+RW, and CDDA+MP3.

**Supported Medium Formats (File Systems)**

The medium formats supported by the radio are ISO 9660 Level 1 and Level 2 and includes the Joliet extension. When reading discs recorded using formats other than ISO 9660 Level 1 and Level 2, the radio may fail to read files properly and may be unable to play the file normally. UDF and Apple HFS formats are not supported.

The radio uses the following limits for file systems:

- Maximum number of directory levels: 8
- Maximum number of files: 255
- Maximum number of folders: 100
- Maximum number of characters in file/folder names:
  - Level 1: 12 (including a separator "." and a three-character extension)
  - Level 2: 31 (including a separator "." and a three-character extension)

Multisession disc formats are supported by the radio. Multisession discs may contain combinations of normal CD audio tracks and computer files (including MP3/WMA files). Discs created with an option such as "keep disc open after writing" are most likely multisession discs. The use of multisession for CD audio or MP3/WMA playback may result in longer disc loading times.

If a disc contains multi-formats, such as CD audio and MP3/WMA tracks, the radio will only play the MP3/WMA tracks on that disc.

### **Supported MP3/WMA File Formats**

The radio will recognize only files with the MP3/WMA extension as MP3/WMA files. Non-MP3/WMA files named with the MP3/WMA extension may cause playback problems. The radio is designed to recognize the file as an invalid MP3/WMA and will not play the file.

When using the MP3/WMA encoder to compress audio data to an MP3/WMA file, the bit rate and sampling frequencies in the following table are supported. In addition, variable bit rates (VBR) are also supported. The majority of MP3/WMA files use a 44.1 kHz sampling rate and a 192, 160, 128, 96 or VBR bit rates.



<b>MPEG Specification</b>	<b>Sampling Frequency (kHz)</b>	<b>Bit Rate (kbps)</b>
MPEG-1 Audio Layer 3	48, 44.1, 32	320, 256, 224, 192, 160, 128, 112, 96, 80, 64, 56, 48
MPEG-2 Audio Layer 3	24, 22.05, 16	160, 128, 144, 112, 96, 80, 64, 56, 48

<b>WMA Specification</b>	<b>Sampling Frequency (kHz)</b>	<b>Bit Rate (kbps)</b>
WMA	44.1 and 48	48, 64, 96, 128, 160, 192 VBR

ID3 Tag information for artist, song title, and album title are supported for ID3 version 1 tags. ID3 version 2 is not supported by the radios.

Playlist files are not supported. MP3 Pro files are not supported.

### Playback of MP3/WMA Files

When a medium containing MP3/WMA data is loaded, the radio checks all files on the medium. If the medium contains a lot of folders or files, the radio will take more time to start playing the MP3/WMA files.

Loading times for playback of MP3/WMA files may be affected by the following:

- Media - CD-RW media may take longer to load than CD-R media
- Medium formats - Multisession discs may take longer to load than non-multisession discs
- Number of files and folders - Loading times will increase with more files and folders

To increase the speed of disc loading, it is recommended to use CD-R media and single-session discs. To create a single-session disc, enable the “Disc at Once” option before writing to the disc.

**LIST Button (DISC Mode for MP3/WMA Play)**

Pressing the LIST button will bring up a list of all folders on the disc. Scrolling up or down the list is done by turning the TUNE/SCROLL control knob. Selecting a folder by pressing the TUNE/SCROLL control knob will begin playing the files contained in that folder (or the next folder in sequence if the selection does not contain playable files).

The folder list will time out after five seconds.

**INFO Button (DISC Mode for MP3/WMA Play)**

Pressing the INFO button repeatedly will scroll through the following TAG information: Song Title, Artist, File Name, and Folder Name (if available).

Press the INFO button once more to return to "elapsed time" priority mode.

Press and hold the INFO button for three seconds or more and radio will display song titles for each file.

Press and hold the INFO button again for three seconds to return to "elapsed time" display.

**Operation Instructions - Auxiliary Mode**

The auxiliary (AUX) jack is an audio input jack, which allows the user to plug in a portable device such as an MP3/WMA player, cassette player, or microphone and utilize the vehicle's audio system to amplify the source and play through the vehicle speakers.

Pressing the AUX button will change the mode to auxiliary device if the AUX jack is connected.

**NOTE:** The AUX device must be turned on and the device's volume set to the proper level. If the AUX audio is not loud enough, turn the device's volume up. If the AUX audio sounds distorted, turn the device's volume down.

**SEEK Button (Auxiliary Mode)**

No function.

**SCAN Button (Auxiliary Mode)**

No function.

**EJECT Button (Auxiliary Mode)**

No function.

**TIME Button (Auxiliary Mode)**

Press the TIME button to change the display from elapsed playing time to time of day. The time of day will display for five seconds.

**RW/FF (Auxiliary Mode)**

No function.

**SET Button (Auxiliary Mode)**

No function.

**Operating Instructions — Voice Recognition System (VR) (If Equipped)**

For the radio, refer to “Voice Recognition System (VR)” in Section 3.

For UConnect® “Voice Recognition System (VR),” refer to “Hands-Free Communication (UConnect®)” in Section 3.

**Operating Instructions - Hands-Free Phone (UConnect®) (If Equipped)**

Refer to “Hands-Free Communication (UConnect®)” in Section 3.

**Operating Instructions - Satellite Radio Mode (If Equipped)**

Refer to “Satellite Radio” in this section.

**Operating Instructions - Video Entertainment System (VES®) (If Equipped)**

Refer to separate “Video Entertainment System (VES®) Guide.”

**Dolby®**

Manufactured under license from Dolby® Laboratories. "Dolby®" and the double-D symbol are trademarks of Dolby® Laboratories.

**Macrovision**

This product incorporates copyright protection technology that is protected by U.S. patents and other intellectual property rights. Use of this copyright protection technology must be authorized by Macrovision, and is intended for home and other limited viewing uses only, unless otherwise authorized by Macrovision. Reverse engineering or disassembly is prohibited

**DTS™**

"DTS™" and "DTS™ 2.0" are trademarks of Digital Theater Systems, Inc.

## SALES CODE RES — AM/FM STEREO RADIO WITH CD PLAYER (MP3 AUX JACK)

**NOTE:** The radio sales code is located on the lower right side of your radio faceplate.

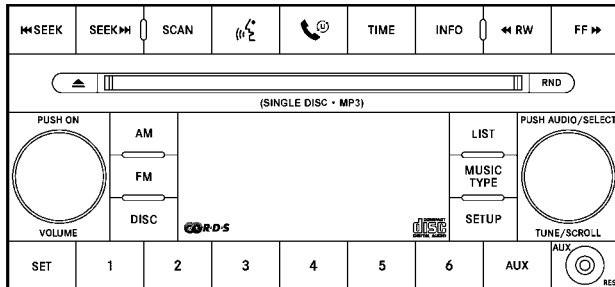

81c7c564

**RES Radio (Non-Satellite Model Shown -  
With Satellite Similar)**

## Operating Instructions - Radio Mode

**NOTE:** The ignition switch must be in the ON or ACC position to operate the radio.

### Power Switch/Volume Control (Rotary)

Push the On/Volume control knob to turn on the radio. Push the On/Volume control knob a second time to turn off the radio.

### Electronic Volume Control

The electronic volume control turns continuously (360 degrees) in either direction without stopping. Turning the On/Volume control knob to the right increases the volume and to the left decreases it.

When the audio system is turned on, the sound will be set at the same volume level as last played.

### SEEK Buttons

Press and release the SEEK buttons to search for the next listenable station in AM/FM mode. Press the right switch

to seek up and the left switch to seek down. The radio will remain tuned to the new station until you make another selection. Holding either button will bypass stations without stopping until you release it.

### SCAN Button

Pressing the SCAN button causes the tuner to search for the next listenable station in AM or FM frequencies, pausing for five seconds at each listenable station before continuing to the next. To stop the search, press the SCAN button a second time.

**Voice Recognition System (Radio) — If Equipped**  
Refer to “Voice Recognition System (VR)” in Section 3.

**Voice Recognition Button (UConnect® Hands-Free Phone) — If Equipped**

Press this button to operate the Hands-Free Phone (UConnect®) feature (if equipped). Refer to “Hands-Free Communication (UConnect®)” in Section 3.

If your vehicle is not equipped with or this feature is not available on your vehicle, a “Not Equipped With UConnect” message will display on the radio screen.

### **Phone Button (UConnect® Hands-Free Phone) — If Equipped**

Press this button to operate the Hands-Free Phone (UConnect®) feature (if equipped). Refer to “Hands-Free Communication (UConnect®)” in Section 3.

If your vehicle is not equipped with or this feature is not available on your vehicle, a “Not Equipped With UConnect” message will display on the radio screen.

### **TIME Button**

Press the TIME button and the time of day will display. In AM or FM mode, pressing the TIME button will switch between the time and frequency displays.

### **Clock Setting Procedure**

1. Press and hold the TIME button, until the hours blink.

2. Adjust the hours by turning the right side Tune/Scroll control knob.

3. After adjusting the hours, press the right side Tune/Scroll control knob to set the minutes. The minutes will begin to blink.

4. Adjust the minutes using the right side Tune/Scroll control knob. Press the Tune/Scroll control knob to save time change.

5. To exit, press any button/knob or wait five seconds.

The clock can also be set by pressing the SETUP button. For vehicles equipped with satellite radio, press the SETUP button, use the Tune/Scroll control to select SET CLOCK, and then follow the above procedure, starting at Step 2. For vehicles not equipped with satellite radio, press the SETUP button and then follow the above procedure, starting at Step 2.

**INFO Button**

Press the INFO button for an RDS station (one with call letters displayed). The radio will return a Radio Text message broadcast from an FM station (FM mode only).

**RW/FF**

Pressing the RW (Rewind) or FF (Fast Forward) buttons causes the tuner to search for the next frequency in the direction of the arrows. This feature operates in either AM or FM frequencies.

**TUNE Control**

Turn the rotary Tune/Scroll control knob clockwise to increase or counterclockwise to decrease the frequency.

**Setting the Tone, Balance, and Fade**

Push the rotary Tune/Scroll control knob and BASS will display. Turn the Tune/Scroll control knob to the right or left to increase or decrease the bass tones.

Push the rotary Tune/Scroll control knob a second time and MID will display. Turn the Tune/Scroll control knob to the right or left to increase or decrease the mid-range tones.

Push the rotary Tune/Scroll control knob a third time and TREBLE will display. Turn the Tune/Scroll control knob to the right or left to increase or decrease the treble tones.

Push the rotary Tune/Scroll control knob a fourth time and BALANCE will display. Turn the Tune/Scroll control knob to the right or left to adjust the sound level from the right or left side speakers.

Push the rotary Tune/Scroll control knob a fifth time and FADE will display. Turn the Tune/Scroll control knob to the left or right to adjust the sound level between the front and rear speakers.

Push the rotary Tune/Scroll control knob again to exit setting tone, balance, and fade.

**MUSIC TYPE Button**

Pressing this button once will turn on the Music Type mode for five seconds. Pressing the MUSIC TYPE button or turning the Tune/Scroll control knob within five seconds will allow the program format type to be selected. Many radio stations do not currently broadcast Music Type information.

Toggle the MUSIC TYPE button to select the following format types:

<b>Program Type</b>	<b>16-Digit Character Display</b>
No program type or undefined	None
Adult Hits	Adlt Hit
Classical	Classicl
Classic Rock	Cls Rock
College	College
Country	Country
Foreign Language	Language

<b>Program Type</b>	<b>16-Digit Character Display</b>
Information	Inform
Jazz	Jazz
News	News
Nostalgia	Nostalga
Oldies	Oldies
Personality	Persnlty
Public	Public
Rhythm and Blues	R & B
Religious Music	Rel Musc
Religious Talk	Rel Talk
Rock	Rock
Soft	Soft
Soft Rock	Soft Rck
Soft Rhythm and Blues	Soft R & B
Sports	Sports
Talk	Talk



Program Type	16-Digit Character Display
Top 40	Top 40
Weather	Weather

By pressing the SEEK button when the Music Type icon is displayed, the radio will be tuned to the next frequency station with the same selected Music Type name. The Music Type function only operates when in the FM mode.

If a preset button is activated while in the Music Type (Program Type) mode, the Music Type mode will be exited and the radio will tune to the preset station.

### SETUP Button

Pressing the SETUP button allows you to select between the following items:

- **Set Clock** — Pressing the SELECT button will allow you to set the clock. Turn the Tune/Scroll control knob to adjust the hours and then press and turn the

Tune/Scroll control knob to adjust the minutes. Press the Tune/Scroll control knob again to save changes.

### AM and FM Buttons

Press the buttons to select AM or FM modes.

#### SET Button — To Set the Pushbutton Memory

When you are receiving a station that you wish to commit to pushbutton memory, press the SET button. The symbol SET 1 will now show in the display window. Select the button (1 to 6) you wish to lock onto this station and press and release that button. If a button is not selected within five seconds after pressing the SET button, the station will continue to play but will not be stored into pushbutton memory.

You may add a second station to each pushbutton by repeating the above procedure with this exception: Press the SET button twice and SET 2 will show in the display window. Each button can be set for SET 1 and SET 2 in both AM and FM. This allows a total of 12 AM and 12 FM

stations to be stored into pushbutton memory. The stations stored in SET 2 memory can be selected by pressing the pushbutton twice.

Every time a preset button is used, a corresponding button number will display.

### **Buttons 1 - 6**

These buttons tune the radio to the stations that you commit to pushbutton memory (12 AM and 12 FM stations).

### **DISC Button**

Pressing the DISC button will allow you to switch from AM/FM modes to Disc modes.

### **Operation Instructions - CD MODE for CD and MP3 Audio Play**

**NOTE:** The ignition switch must be in the ON or ACC position to operate the radio.

**NOTE:** This radio is capable of playing compact discs (CD), recordable compact discs (CD-R), rewritable compact discs (CD-RW), compact discs with MP3 tracks and multisession compact discs with CD and MP3 tracks.

### **Inserting Compact Disc(s)**

Gently insert one CD into the CD player with the CD label facing up. The CD will automatically be pulled into the CD player and the CD icon will illuminate on the radio display. If a CD does not go into the slot more than 1.0 in (2.5 cm), a disc may already be loaded and must be ejected before a new disc can be loaded.

If you insert a disc with the ignition ON and the radio ON, the unit will switch from radio to CD mode and begin to play when you insert the disc. The display will show the disc number, the track number, and index time in minutes and seconds. Play will begin at the start of track 1.

**CAUTION!**

- **This CD player will accept 4-3/4 in (12 cm) discs only. The use of other sized discs may damage the CD player mechanism.**
- **Do not use adhesive labels. These labels can peel away and jam the player mechanism.**
- **RES is a single CD player. Do not attempt to insert a second CD if one is already loaded.**
- **Dual-media disc types (one side is a DVD, the other side is a CD) should not be used, and they can cause damage to the player.**

**EJECT Button - Ejecting a CD**

Press the EJECT button to eject the CD.



If you have ejected a disc and have not removed it within 10 seconds, it will be reloaded. If the CD is not removed, the radio will reinsert the CD but will not play it.

A disc can be ejected with the radio and ignition OFF.

**NOTE:** Ejecting with ignition OFF is not allowed on convertible or soft-top models (if equipped).

**SEEK Button**

Press the right SEEK button for the next selection on the CD. Press the left SEEK button to return to the beginning of the current selection, or return to the beginning of the previous selection if the CD is within the first second of the current selection. Pressing and holding the SEEK button will allow faster scrolling through the tracks in CD, MP3 modes.

**SCAN Button**

Press the SCAN button to scan through each track on the CD currently playing.

**TIME Button**

Press this button to change the display from a large CD playing time display to a small CD playing time display.

**RW/FF**

Press the RW button to stop the CD at the beginning of the current CD track/title.

Press and hold FF (Fast Forward) and the CD player will begin to fast forward until FF is released or RW or another CD button is pressed. The RW (Reverse) button works in a similar manner.

**AM or FM Button**

Switches the AM or FM radio to the opposite radio mode.

**RND Button (Random Play Button)**

Press this button while the CD is playing to activate Random Play. This feature plays the selections on the compact disc in random order to provide an interesting change of pace.

Press the right SEEK button to move to the next randomly selected track.

Press the RND button a second time to stop Random Play.

**Notes On Playing MP3 Files**

The radio can play MP3 files; however, acceptable MP3 file recording media and formats are limited. When writing MP3 files, pay attention to the following restrictions.

**Supported Media (Disc Types)**

The MP3 file recording media supported by the radio are CDDA, CD-R, CD-RW, MP3, and CDDA+MP3.

**Supported Medium Formats (File Systems)**

The medium formats supported by the radio are ISO 9660 Level 1 and Level 2 and includes the Joliet extension. When reading discs recorded using formats other than ISO 9660 Level 1 and Level 2, the radio may fail to read

files properly and may be unable to play the file normally. UDF and Apple HFS formats are not supported.

The radio uses the following limits for file systems:

- Maximum number of folder levels: 8
- Maximum number of files: 255
- Maximum number of folders. (The radio display of file names and folder names is limited. For large numbers of files and/or folders, the radio may be unable to display the file name and folder name and will assign a number instead. With a maximum number of files, exceeding 20 folders will result in this display. With 200 files, exceeding 50 folders will result in this display.)
- Maximum number of characters in file/folder names:
  - Level 1: 12 (including a separator "." and a three-character extension)
  - Level 2: 31 (including a separator "." and a three-character extension)

Multisession disc formats are supported by the radio. Multisession discs may contain combinations of normal CD audio tracks and computer files (including MP3 files). Discs created with an option such as "keep disc open after writing" are most likely multisession discs. The use of multisession for CD audio or MP3 playback may result in longer disc loading times.

### Supported MP3 File Formats

The radio will recognize only files with the \*.MP3 extension as MP3 files. Non-MP3 files named with the \*.MP3 extension may cause playback problems. The radio is designed to recognize the file as an invalid MP3 and will not play the file.

When using the MP3 encoder to compress audio data to an MP3 file, the bit rate and sampling frequencies in the following table are supported. In addition, variable bit

rates (VBR) are also supported. The majority of MP3 files use a 44.1 kHz sampling rate and a 192, 160, 128, 96 or VBR bit rates.

MPEG Specification	Sampling Frequency (kHz)	Bit Rate (kbps)
MPEG-1 Audio Layer 3	48, 44.1, 32	320, 256, 224, 192, 160, 128, 112, 96, 80, 64, 56, 48, 40, 32
MPEG-2 Audio Layer 3	24, 22.05, 16	160, 128, 144, 112, 96, 80, 64, 56, 48, 40, 32, 24, 16, 8

ID3 Tag information for artist, song title, and album title are supported for version 1 ID3 tags. ID3 version 2 is not supported by the radios.

Playlist files are not supported. MP3 Pro files are not supported.

### Playback of MP3 Files

When a medium containing MP3 data is loaded, the radio checks all files on the medium. If the medium contains a lot of folders or files, the radio will take more time to start playing the MP3 files.

Loading times for playback of MP3 files may be affected by the following:

- Media - CD-RW media may take longer to load than CD-R media
- Medium formats - Multisession discs may take longer to load than non-multisession discs
- Number of files and folders - Loading times will increase with more files and folders

To increase the speed of disc loading, it is recommended to use CD-R media and single-session discs. To create a single-session disc, enable the “Disc at Once” option before writing to the disc.

**LIST Button (CD Mode for MP3 Play)**

Pressing the LIST button will bring up a list of all folders on the disc. Scrolling up or down the list is done by turning the Tune/Scroll control knob. Selecting a folder by pressing the Tune/Scroll control knob will begin playing the files contained in that folder (or the next folder in sequence if the selection does not contain playable files).

The folder list will time out after five seconds.

**INFO Button (CD Mode for MP3 Play)**

Pressing the INFO button repeatedly will scroll through the following TAG information: Song Title, Artist, File Name, and Folder Name (if available).

Press the INFO button once more to return to "elapsed time" priority mode.

Press and hold the INFO button for three seconds or more and the radio will display song titles for each file.

Press and hold the INFO button again for three seconds to return to "elapsed time" display.

**Operation Instructions - Auxiliary Mode**

The auxiliary (AUX) jack is an audio input jack, which allows the user to plug in a portable device such as an MP3 player, or cassette player, and utilize the vehicle's audio system to amplify the source and play through the vehicle speakers.

Pressing the AUX button will change the mode to auxiliary device if the AUX jack is connected.

**NOTE:** The AUX device must be turned on and the device's volume set to proper level. If the AUX audio is not loud enough, turn the device's volume up. If the AUX audio sounds distorted, turn the device's volume down.

**TIME Button (Auxiliary Mode)**

Press this button to change the display to time of day. The time of day will display for five seconds (when ignition is OFF).

**Operating Instructions - Hands-Free Phone (UConnect®) (If Equipped)**

Refer to “Hands-Free Communication (UConnect®)” in Section 3.

**Operating Instructions - Satellite Radio Mode (If Equipped)**

Refer to “Satellite Radio” in this section.

**Operating Instructions - Video Entertainment System (VES)® (If Equipped)**

Refer to separate “Video Entertainment System (VES)® Guide.”

**SALES CODE REU — MULTIMEDIA SYSTEM — IF EQUIPPED**

**NOTE:** The sales code is located on the lower right side of the unit’s faceplate.

The REU Multimedia system contains a radio, Sirius Satellite Radio player, navigation system, six disc CD/DVD player, USB port, 30-gigabyte hard drive (HDD), and the UConnect® Hands-Free Bluetooth® cellular system.

A 7 in (17.8 cm) remote screen allows easy menu selection, while the Advanced Voice Dialog System recognizes more than 1,000 words for audio, navigation, entertainment, and hands-free mobile phone use.

The satellite navigation capability combines a Global-Positioning System (GPS)-based navigation system with



a remote color screen to provide maps, turn identification, selection menus, and instructions for selecting a variety of destinations and routes.

A shared HDD for the navigation system, the database, and other radio features allows uploads of music and photos from CDs or through the USB port. The Gracenote database finds the artist, track, and title for the music.

An auxiliary input jack permits passengers to listen to a portable MP3 player through the vehicle's speakers. For vehicles equipped with the Video Entertainment System (VES)<sup>®</sup>, separate audio outputs allow passengers to listen to the vehicle speakers while different audio tracks play through the system's wireless headphones. This means rear-seat passengers can watch a DVD on the optional rear-seat entertainment system while the driver and front-seat passenger listen to the radio.

Other special features include music type selections, traffic messaging (optional), easy store presets, parental

lockout for VES<sup>®</sup> (if equipped), and a backup camera display for vehicles equipped with a backup camera. Refer to your "Navigation User's Manual" for detailed operating instructions.

### **Operating Instructions — Satellite Radio**

Refer to your "Navigation User's Manual" for detailed operating instructions.

### **Operating Instructions — Hands-Free Communication (UConnect<sup>®</sup>) (If Equipped)**

Refer to your "Navigation User's Manual" for detailed operating instructions.

### **Clock Setting Procedure**

The GPS receiver in this system is synchronized to the time data being transmitted by the GPS satellites. The satellites' clock is Greenwich Mean Time (GMT). This is the worldwide standard for time. This makes the system's clock very accurate once the appropriate time zone and daylight savings information is set.

## Changing the Time Zone

**NOTE:** You can skip Steps 2 and 3 by pressing and holding the “TIME” button on the radio for three seconds.

1. Turn on the multimedia system.
2. Press and release the “SETUP” button on the radio.
3. If “Time Setup” is highlighted on the menu, press and release the joystick in the center of the radio. Otherwise, turn the knob surrounding the joystick to select “Time Setup,” and then press and release the joystick.
4. Turn the knob surrounding the joystick to scroll to “Time Zone,” and then press and release the joystick.
5. If the desired time zone setting has a check mark next to it, proceed to the next step. Otherwise, turn the knob

surrounding the joystick to select the desired time zone setting, and then press and release the joystick. A check mark will display next to the selection.

6. Press and release the “SETUP” button to exit the screen.

## Changing Daylight Savings Time

When On is selected, this feature will display the time of day in daylight savings time. Proceed as follows to change the current setting:

**NOTE:** You can skip Steps 2 and 3 by pressing and holding the “TIME” button on the radio for three seconds.

1. Turn on the multimedia system.
2. Press and release the “SETUP” button on the radio.
3. If “Time Setup” is highlighted on the menu, press and release the joystick in the center of the radio. Otherwise,

turn the knob surrounding the joystick to select “Time Setup,” and then press and release the joystick.

4. Turn the knob surrounding the joystick to scroll to “Daylight Savings,” and then press and release the joystick.

5. If the desired setting has a check mark next to it, proceed to the next step. Otherwise, turn the knob surrounding the joystick to select “Off” or “On,” and then press and release the joystick. A check mark will display next to the selection.

6. Press and release the “SETUP” button to exit the screen.

### Setting the User Clock

If you wish to set the clock to a time different from the system clock, you can manually adjust the time by performing the following:

**NOTE:** You can skip Steps 2 and 3 by pressing and holding the “TIME” button on the radio for three seconds.

1. Turn on the multimedia system.
2. Press and release the “SETUP” button on the radio.
3. If “Time Setup” is highlighted on the menu, press and release the joystick in the center of the radio. Otherwise, turn the knob surrounding the joystick to select “Time Setup,” and then press and release the joystick.
4. If “User Time” has a check mark next to it, proceed to the next step. Otherwise, turn the knob surrounding the joystick to scroll to “User Time,” and then press and release the joystick.
5. Turn the knob surrounding the joystick to select “Set Hours,” and then press and release the joystick.

6. Turn the knob surrounding the joystick to set the hour highlighted on the clock on the screen. Press and release the joystick when done.
7. Turn the knob surrounding the joystick to select “Set Minutes,” and then press and release the joystick.
8. Turn the knob surrounding the joystick to set the minutes highlighted on the clock on the screen. Press and release the joystick when done.
9. Press and release the “SETUP” button to exit the screen.

### **Show Time if Radio is Off**

When selected, this feature will display the time of day on the screen when the system is turned off. Proceed as follows to change the current setting:

**NOTE:** You can skip Steps 2 and 3 by pressing and holding the “TIME” button on the radio for three seconds.

1. Turn on the multimedia system.
2. Press and release the “SETUP” button on the radio.
3. If “Time Setup” is highlighted on the menu, press and release the joystick in the center of the radio. Otherwise, turn the knob surrounding the joystick to select “Time Setup,” and then press and release the joystick.
4. Turn the knob surrounding the joystick to scroll to “Clock if Radio off,” and then press and release the joystick to change the current setting. A check mark will display next to “Clock if Radio off” when the feature is selected.
5. Press and release the “SETUP” button to exit the screen.

## **SATELLITE RADIO — IF EQUIPPED (REN/REQ/RER/RES/REU RADIOS ONLY)**

Satellite radio uses direct satellite-to-receiver broadcasting technology to provide clear digital sound, coast to coast. The subscription service provider is Sirius Satellite Radio. This service offers over 130 channels of music, sports, news, entertainment, and programming for children, directly from its satellites and broadcasting studios.

**NOTE:** Sirius service is not available in Hawaii and has limited coverage in Alaska.

### **System Activation**

Sirius Satellite Radio service is pre-activated, and you may begin listening immediately to the one year of audio service that is included with the factory-installed satellite radio system in your vehicle. Sirius will supply a welcome kit that contains general information, including how to setup your on-line listening account at no additional charge. For further information, call the toll-free

number 888-539-7474, or visit the Sirius web site at [www.sirius.com](http://www.sirius.com), or at [www.siriuscanada.ca](http://www.siriuscanada.ca) for Canadian residents.

### **Electronic Serial Number/Sirius Identification Number (ESN/SID)**

Please have the following information available when calling:

1. The Electronic Serial Number/Sirius Identification Number (ESN/SID).
2. Your Vehicle Identification Number.

To access the ESN/SID, refer to the following steps:

### **ESN/SID Access With REQ/RES Radios**

With the ignition switch in the ON/RUN or ACC position and the radio on, press the SETUP button and scroll using the Tune/Scroll control knob until Sirius ID is selected. Press the Tune/Scroll control knob and the

Sirius ID number will display. The Sirius ID number display will time out in two minutes. Press any button on the radio to exit this screen.

### **ESN/SID Access With REN/RER Radios**

While in SAT mode, press the MENU button on the radio faceplate.

Next, touch the SUBSCRIPTION tab on the touch screen. All the ESNs that apply to your vehicle will display.

### **ESN/SID Access With REU Radio**

While in SAT mode, press the MENU button on the radio faceplate.

Next, turn the knob surrounding the joystick in the center of the radio to scroll to Subscription, and then press and release the joystick. All of the ESNs that apply to your vehicle will display.

### **Selecting Satellite Mode**

Press the SAT button until "SAT" appears in the display. A CD may remain in the radio while in the Satellite radio mode.

### **Satellite Antenna**

To ensure optimum reception, do not place items on the roof around the rooftop antenna location or strap items to the trunk lid around the trunk lid antenna (if equipped). Metal objects placed within the line of sight of the antenna will cause decreased performance. Larger luggage items such as bikes should be placed as far rearward as possible, within the loading design of the rack. Do not place items directly on or above the antenna.

### **Reception Quality**

Satellite reception may be interrupted due to one of the following reasons:

- The vehicle is parked in an underground parking structure or under a physical obstacle.

- Dense tree coverage may interrupt reception in the form of short audio mutes.
- Driving under wide bridges or along tall buildings can cause intermittent reception.
- Placing objects over or too close to the antenna can cause signal blockage.

### Operating Instructions - Satellite Mode

**NOTE:** The ignition switch must be in the ON or ACC position to operate the radio.

#### SEEK Buttons

Press and release the SEEK buttons to search for the next channel in Satellite mode. Press the right switch to seek up and the left switch to seek down. The radio will remain tuned to the new channel until you make another selection. Holding either button will bypass channels without stopping until you release it.

#### SCAN Button

Pressing the SCAN button causes the tuner to search for the next channel, pausing for eight seconds before continuing to the next. To stop the search, press the SCAN button a second time.

#### INFO Button — Except REU Radio

Pressing the INFO button will cycle the display information between Artist, Song Title, and Composer (if available). Also, pressing and holding the INFO button for an additional three seconds will make the radio display the Song Title all of the time (press and hold again to return to normal display).

#### INFO Button — REU Radio

Pressing the INFO button will display information about Artist, Song Title, and Composer (if available). Pressing the INFO button again will close the INFO screen.

**RW/FF**

Pressing the RW (Rewind) or FF (Fast Forward) buttons causes the tuner to search for the next channel in the direction of the arrows.

**TUNE Control (Rotary)**

Turn the rotary Tune/Scroll control knob clockwise to increase or counterclockwise to decrease the channel.

**MUSIC TYPE Button — Except REU Radio**

Pressing this button once will turn on the Music Type mode for five seconds. Pressing the MUSIC TYPE button or turning the Tune/Scroll control knob within five seconds will allow the program format type to be selected.

Toggle the MUSIC TYPE button again to select the music type.

By pressing the SEEK button when the Music Type function is active, the radio will be tuned to the next channel with the same selected Music Type name.

If a preset button is activated while in the Music Type (Program Type) mode, the Music Type mode will be exited and the radio will tune to the preset channel.

**MUSIC TYPE Button — REU Radio**

Pressing this button provides a MUSIC TYPES list from which you can make a selection. Once a selection is made, you can seek up, or down, or scan the channels and the radio will tune to the next station matching the selected format. There is no time-out for this screen. Pressing the MUSIC TYPE button again will close the MUSIC TYPE screen. Once closed, seek up, seek down, and scan will no longer be based on your selection.

**SETUP Button**

Pressing the SETUP button allows you to select the following items:



- Display Sirius ID number — Press the AUDIO/SELECT button to display the Sirius ID number. This number is used to activate, deactivate, or change the Sirius subscription.

### **SET Button – To Set the Pushbutton Memory**

When you are receiving a channel that you wish to commit to pushbutton memory, press the SET button. The symbol SET 1 will now show in the display window. Select the button (1-6) you wish to lock onto this channel and press and release that button. If a button is not selected within five seconds after pressing the SET button, the channel will continue to play but will not be stored into pushbutton memory.

You may add a second channel to each pushbutton by repeating the above procedure with this exception: Press the SET button twice and SET 2 will show in the display window. Each button can be set for SET 1 and SET 2. This allows a total of 12 Satellite channels to be stored into

pushbutton memory. The channels stored in SET 2 memory can be selected by pressing the pushbutton twice.

Every time a preset button is used, a corresponding button number will display.

### **Buttons 1 - 6**

These buttons tune the radio to the channels that you commit to pushbutton memory (12 Satellite stations).

### **Operating Instructions - Hands-Free Phone (If Equipped)**

Refer to “Hands-Free Communication (UConnect®)” in Section 3.

### **Operating Instructions - Video Entertainment System (VES®) (If Equipped)**

Refer to separate “Video Entertainment System (VES®) Guide.”

## VIDEO ENTERTAINMENT SYSTEM — IF EQUIPPED

The optional Video Entertainment System (VES)<sup>®</sup> includes the following components for rear seat entertainment:

- A diagonal 8 in (20 cm) Liquid Crystal Display (LCD) screen integrated into the center overhead console. The screen features brightness control for optimum daytime and nighttime viewing.
- The LCD Screen swings down from the console to allow the rear seat passenger(s) to view the display.

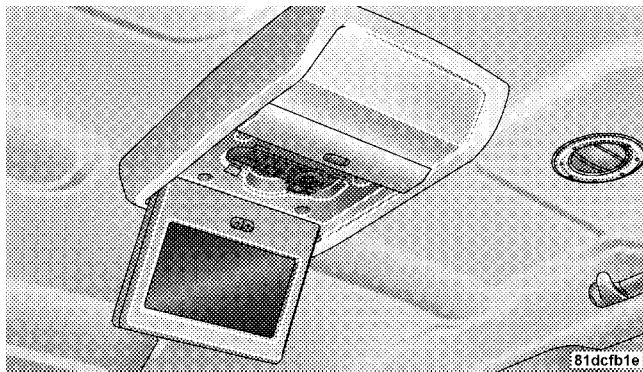

### Video Screen and Remote Storage

- The touch screen radio and DVD player controls allow front seat operation for easy setup in the case of younger rear seat passengers.
- A battery-powered infrared remote control that snaps into a molded compartment in the center console.

- Two wireless infrared headsets allow rear seat passengers to listen to the same or individual audio sources.

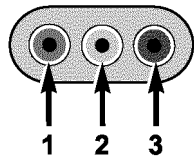

Audio/Video RCA Jacks (AUX Jacks) on the rear of the center console enable the monitor to display video directly from a video camera, connect video games for display on the screen, or play music directly from an MP3 player.

1. Video in (yellow)
2. Left audio in (white)
3. Right audio in (red)

**NOTE:** Refer to your “Vehicle Entertainment System (VES)<sup>®</sup> User Manual” for detailed operating instructions.

## UNIVERSAL CONSUMER INTERFACE (UCI) — IF EQUIPPED

**NOTE:** This section is for sales code RES/REL and REQ/RET radios only with UConnect<sup>®</sup>. For sales code REN/REZ touch screen radio and REU/REX/RE1 radio, refer to the separate User’s Manual.

This feature allows you to plug an iPod<sup>®</sup> mobile digital device into the vehicle’s sound system through a connector (UCI connector) using an optional connection cable (available through MOPAR<sup>®</sup>). See your authorized dealer for details.

Using this feature,

- the iPod<sup>®</sup> audio can be played on the vehicle’s sound system, providing metadata (Track Title, Artist, Album, etc.) information display on radio.
- the iPod<sup>®</sup> can be controlled using the radio buttons to Play, Browse and List the iPod<sup>®</sup> contents.

- the iPod® battery charges when plugged into the UCI connector.

### **Connecting The iPod® Device**

Use the optional connection cable to connect an iPod® to the vehicle's UCI connector (which is located in the glove box or center console on some vehicles. This location may vary with vehicle). Once the iPod® is connected and synchronized to the vehicle system (this may take a few seconds to connect), the vehicle brand logo appears on the iPod® display, and it starts charging and is ready for use by pressing radio switches as described below.

### **Controlling The iPod® Using Radio Buttons**

To get into the UCI (iPod®) mode and access a connected iPod®, press the AUX button on the radio faceplate. Once in the UCI (iPod®) mode, the iPod® audio track (if available from iPod®) will start playing over the vehicle audio system.

### **Play Mode**

When switched to UCI mode the iPod® will be in Play mode. In Play mode, you may use the following buttons on the radio faceplate to control the iPod® and display data:

#### ***Tune/Scroll Knob***

Use the Tune/Scroll knob to go to the next or previous track.

The Tune/Scroll knob functions similar to the scroll wheel on the iPod® mobile digital device.

Turning it clockwise (forward) by one click while playing a track skips to the next track.

Turning it counterclockwise (backward) by one click during the first two seconds of the track will jump to the previous track in the list and turning this button at any other time in the track will jump to the beginning of the current track.

***RW (Rewind) Button***

Press and hold the RW button to move backward in the current track. Holding the RW button long enough will take you back to the beginning of the current track.

Pressing and releasing the RW button will go back five seconds of the current track.

***FF (Fast Forward) Button***

Press and hold the FF button to move forward in the current track.

Pressing and releasing the FF button will go forward five seconds of the current track.

***SEEK Buttons***

Use the SEEK buttons to move to the previous or the next track.

If the left (down) button is pressed during the first two seconds of the current track, it will go back to the

previous track in the list; if you press this button at any other time in the current track it will go back to the beginning of the track.

If the right (up) button is pressed during Play mode, it will go to the next track in the list.

***INFO Button***

Press the INFO button while a track is playing to see the information (Track Title, Artist, Album, etc.) for that track. Each press of the INFO button will take you to the next screen of data for that track. Once you have seen all of the screens, the last press of the INFO button will take you back to the Play mode screen on the radio.

***REPEAT Button***

Press the REPEAT button to repeat the current playing track.

**SCAN Button**

Pressing the SCAN button will play the first five seconds of each track in the current list and then forward to the next song. To stop the SCAN mode and start playing the desired track, press the SCAN button again.

During the SCAN mode, you can also press the SEEK button to the left or right to go to the previous or next tracks.

**RND (Random) Button (RES/REL Radios Only)**

Pressing the RND button will switch between the shuffle on and shuffle off modes of the iPod®. If the RND icon is showing on the radio display then the Shuffle mode is on.

**List or Browse Mode**

During Play mode, pressing any of the following buttons will take you to List mode. List mode enables you to scroll through the list of menus and tracks on the iPod® device.

**Tune/Scroll Knob**

In the List mode, the Tune/Scroll knob functions in a similar manner as the scroll wheel on the iPod®.

Turning the Tune/Scroll knob clockwise (forward) and counterclockwise (backward) scrolls through lists, displaying the track detail on the radio display. Once you have the track to be played highlighted on the radio display, press the Tune/Scroll knob to select and start playing the track. By turning the Tune/Scroll knob fast, you can jump through the list faster. During fast scroll, you may notice a slight delay in updating the information on the radio display.

During all List modes, the iPod® will display all lists in “wrap-around” mode. So if the track you wish to select is at the bottom of the list, you just turn the Tune/Scroll knob backward (counterclockwise) to get to the track faster.

### ***Radio Preset Buttons***

In the List mode, the radio preset buttons are used as shortcuts to the following lists on the iPod® device.

- 1 – Playlists
- 2 – Artists
- 3 – Albums
- 4 – Genres
- 5 – Audiobooks
- 6 – Podcasts

After pressing a preset button, you will see the list you are in on the top line and the first item in that list on the second line.

To exit the List mode without selecting a track, press the same preset button again to go back to Play mode.

### ***LIST Button***

Pressing the LIST button will take to the top level menu of the iPod®. This takes you to the same top level menu as on your iPod®. Turn the Tune/Scroll knob to list the top menu item you wish to select and then press the Tune/Scroll knob. This will take you to the next sub menu list item of the iPod® and you can follow the same steps to go to the desired track in that list. Not all iPod® sub menu levels are available on this system.

### ***MUSIC TYPE Button***

The MUSIC TYPE button is another shortcut button to the genre listing on your iPod®.

## REMOTE SOUND SYSTEM CONTROLS — IF EQUIPPED

The remote sound system controls are located on the rear surface of the steering wheel. The left- and right-hand controls are rocker-type switches with a pushbutton in the center of each switch. Reach behind the steering wheel to access the switches.

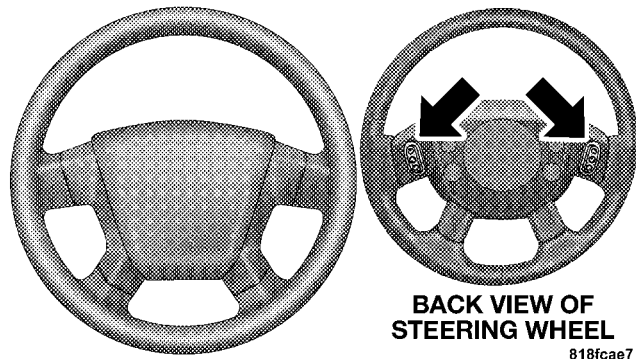

Remote Sound Controls

## Right-Hand Switch Functions

- Press the top of the switch to increase the volume.
- Press the bottom of the switch to decrease the volume.
- Press the button in the center of the switch to change modes (i.e., AM, FM, etc.).

## Left-Hand Switch Functions for Radio Operation

- Press the top of the switch to SEEK the next listenable station up from the current setting.
- Press the bottom of the switch to SEEK the next listenable station down from the current setting.
- Press the button in the center of the switch to tune to the next preset that you have programmed.



## Left-Hand Switch Functions for Media (i.e., CD)

### Operation

- Press the top of the switch once to listen to the next track.
- Press the bottom of the switch once either to listen to the beginning of the current track or to listen to the beginning of the previous track if it is within one second after the current track begins to play.
- Press the switch up or down twice to listen to the second track, three times to listen to the third track, and so forth.
- Press the button located in the center of the switch to change to the next preset that you have programmed.

## CD/DVD MAINTENANCE

To keep the CD/DVD discs in good condition, take the following precautions:

1. Handle the disc by its edge; avoid touching the surface.
2. If a disc is stained, clean the surface with a soft cloth, wiping from center to edge.
3. Do not apply paper, paper CD labels, or tape to the disc; avoid scratching a disc.
4. Do not use solvents such as benzine, thinner, cleaners, or antistatic sprays.
5. Store a disc in its case after playing.
6. Do not expose a disc to direct sunlight.
7. Do not store a disc where temperatures may become too high.

8. Do not play discs that are small in size or have irregular shapes.

### **RADIO OPERATION AND CELLULAR PHONES**

Under certain conditions, the cellular phone being on in your vehicle can cause erratic or noisy performance from your radio. This condition may be lessened or eliminated by relocating the cellular phone antenna. This condition is not harmful to the radio. If your radio performance does not satisfactorily “clear” by the repositioning of the antenna, it is recommended that the radio volume be turned down or off during cellular phone operation.

### **CLIMATE CONTROLS**

The air conditioning and heating system is designed to make you comfortable in all types of weather. For information about basic climate control functions, refer to “General Climate Control Functions — All Systems.” For more detailed information about the climate controls in your vehicle, refer to “Single-Zone Manual Air Conditioning and Heating System,” “Two- and Three-Zone Manual Air Conditioning and Heating Systems,” or “Two- and Three-Zone Automatic Temperature Control (ATC) Systems.”

## General Climate Control Functions — All Systems

### Blower Control

Use this control to regulate the amount of air forced through the ventilation system in any mode.

### Temperature Control

Use this control to regulate the temperature of the air inside the cabin.

### Air Conditioning (A/C) Control



Use this control to engage and disengage the A/C.

#### NOTE:

- The A/C compressor will not engage until the engine has been running for about 10 seconds.
- If A/C performance seems lower than expected, check the front of the A/C condenser (located in front of the radiator) for an accumulation of dirt or insects. Clean

with a gentle water spray from behind the radiator and through the condenser. Fabric front fascia protectors may reduce airflow to the condenser, reducing air conditioning performance.

### Mode Control (Air Direction)

Use these controls to choose from several patterns of air distribution.

- **Panel**



Air is directed through the outlets in the instrument panel. For vehicles equipped with a three-zone system, air is also directed through the outlets in the headliner, unless the climate control for the rear passengers is ON and in Floor mode.

**NOTE:** These outlets are adjustable to direct airflow. For maximum airflow to the rear, aim the center instrument panel outlets so that they are directed toward the rear seat passengers.

- **Bi-Level**



Air is directed through the panel and floor outlets. For vehicles equipped with a three-zone system, air is also directed through the outlets in the headliner, unless the climate control for the rear passengers is ON and in Floor mode.

**NOTE:** For all settings except full cold or full hot, there is a difference in temperature between the upper and lower outlets. The warmer air flows to the floor outlets. This feature gives improved comfort during sunny but cool conditions.

- **Floor**



Air is directed through the floor outlets with a small amount flowing through the defrost and side window demist outlets. For vehicles equipped with a three-zone system, air is directed through the

floor outlet in the right quarter trim panel, unless the climate control for the rear passengers is ON and in Panel mode.

- **Mix**



Air is directed through the floor, defrost, and side window demist outlets. For vehicles equipped with a three-zone system, air is directed through the floor outlet in the right quarter trim panel, unless the climate control for the rear passengers is ON and in Panel mode.

**NOTE:** This setting works best in cold or snowy conditions that require extra heat to the windshield. This setting is good for maintaining comfort while reducing moisture on the windshield.

- **Defrost**



Air is directed through the windshield and side window demist outlets. For vehicles equipped with a three-zone system, air is directed through the floor outlet in the right quarter trim panel, unless the climate control for the rear passengers is ON and in Panel mode.

**NOTE:** Use this mode with maximum blower and temperature settings for best windshield and side window defrosting.

- **Recirculation Control**



Use this button to block the flow of outside air from coming into the passenger compartment.

**NOTE:**

- Only use the Recirculation mode as a temporary means to block out any outside odors, smoke, or dust, and to cool the interior rapidly upon initial start up in very hot or humid weather.
- Continuous use of the Recirculation mode may make the inside air stuffy and window fogging may occur. Extended use of this mode is not recommended.
- The use of the Recirculation mode in cold or damp weather will cause windows to fog on the inside, because of moisture build-up inside the vehicle. Select the outside air position for maximum defogging.

## Single-Zone Manual Air Conditioning and Heating System

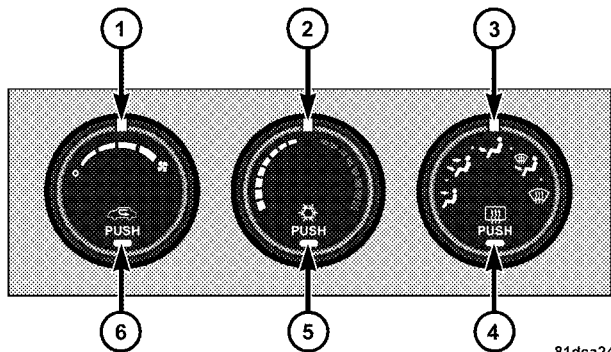

81dca244

### Single-Zone Manual Climate Control

#### 1. Blower Control

The blower speed increases as you move the control to the right from the “O” (Off) position. There are four blower speeds.

#### 2. Temperature Control

Turn left for cooler or right for warmer temperature settings.

#### 3. Mode Control

Turn to select either a primary mode as identified by the symbols on the control, or a blend of two of these modes. The closer the setting is to a particular symbol, the more air distribution you receive from that mode. See Note <sup>1</sup> and <sup>2</sup>

#### 4. Electric Rear Window Defroster Control

Refer to “Rear Window Features” in Section 3 for more information.

#### 5. A/C Control

Press and release to change the current setting. The indicator illuminates when ON. See Note <sup>3</sup>

### 6. Recirculation Mode Control

Press and release to change the current setting. The indicator illuminates when ON.

**Note**<sup>1</sup> - The A/C compressor operates in Mix and Defrost, or a blend of these modes, even if the A/C control is not pressed. This dehumidifies the air to help dry the windshield. To improve fuel economy, use these modes only when necessary.

**Note**<sup>2</sup> - The A/C will engage automatically to prevent fogging when the Recirculation button is pressed and the Mode control is set to Panel or Panel/Floor. The A/C can be deselected manually without disturbing the Mode control selection.

**Note**<sup>3</sup> - For maximum cooling, use A/C and recirculation at the same time. If economy mode is desired, turn OFF the A/C and turn the Temperature control to the desired temperature setting.

### Two- and Three-Zone Manual Air Conditioning and Heating Systems — If Equipped

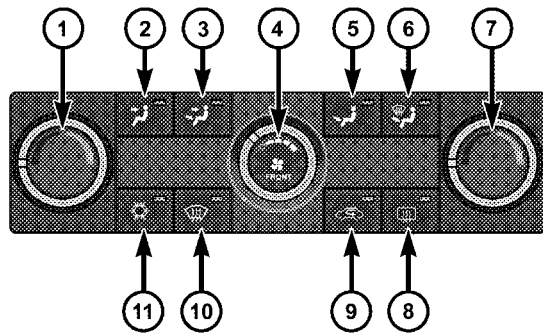

81dc1922

#### Two-Zone Manual Climate Control

##### 1. Left Front Temperature Control

Provides left front seat occupant with independent temperature control. Turn left for cooler or right for warmer temperature settings.

**2. Panel Mode Button**

Press and release to select. The indicator illuminates when selected.

**3. Bi-Level Mode Button**

Press and release to select. The indicator illuminates when selected.

**4. Front Blower Control**

The blower speed increases as you move the control to the right from the “O” (Off) position. There are four blower speeds.

**5. Floor Mode Button**

Press and release to select. The indicator illuminates when selected.

**6. Mix Mode Button**

Press and release to select. The indicator illuminates when selected.

**7. Right Front Temperature Control**

Provides right front seat occupant with independent temperature control. Turn left for cooler or right for warmer temperature settings.

**8. Electric Rear Window Defroster Button**

Refer to “Rear Window Features” in Section 3 for more information.

**9. Recirculation Mode Button**

Press and release to change the current setting. The indicator illuminates when ON.

**10. Defrost Mode Button**

Press and release to select. The indicator illuminates when selected.

**11. A/C Button**

Press and release to change the current setting. The indicator illuminates when ON.



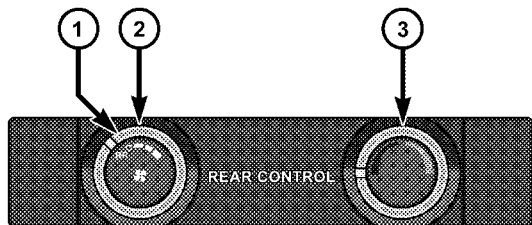

81f4d77d

**Rear-Zone Manual Climate Control****1. RR Control**

Turns the climate control in the overhead console above the second row passenger seats ON and OFF. Press and release to change the current setting.

**2. Rear Blower Control**

The blower speed increases as you move the control to the right from the “O” (Off) position. There are three blower speeds.

**3. Rear Temperature Control**

Provides independent temperature control for the rear cabin. Turn left for cooler or right for warmer temperature settings in the rear cabin.

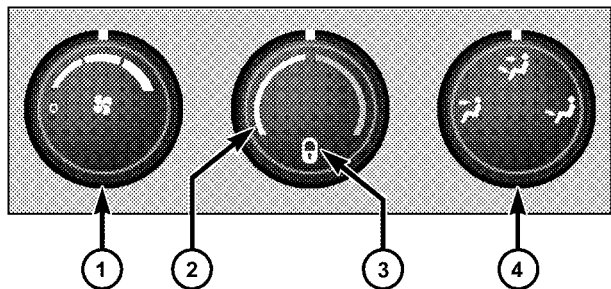

81dc6d95

### Rear-Zone Manual Climate Control

The Rear-Zone Manual Climate Control for the rear passengers is located in the overhead console above the second row passenger seats.

#### **1. Rear Blower Control**

The blower speed increases as you move the control to the right from the "O" (Off) position. There are three blower speeds.

#### **2. Rear Temperature Control**

Provides rear seat occupants with independent temperature control. Turn left for cooler or right for warmer temperature settings in the rear cabin.

#### **3. Lockout**

This indicator illuminates when the climate control is turned OFF by the RR control on the Rear-Zone Manual Climate Control in the instrument panel.

#### **4. Rear Mode Control**

Turn to select Panel, Bi-Level, or Floor for the mode of rear cabin air distribution.

## Two- and Three-Zone Automatic Temperature Control (ATC) Systems — If Equipped

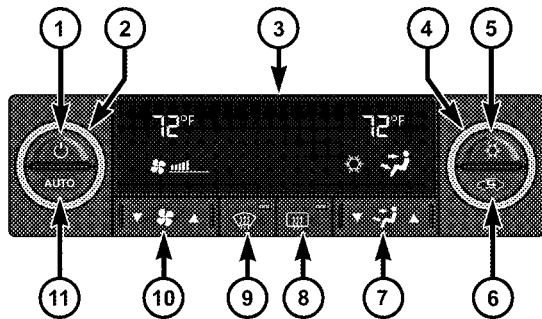

81d198cc

### Two-Zone ATC

#### 1. **ATC ON/OFF Button**

Press and release to change the current setting.

#### 2. **Left Front Temperature Control**

Provides left front seat occupant with independent temperature control. Turn left for cooler or right for warmer temperature settings.

#### 3. **Display Screen**

Shows the current blower speed, mode, and temperature settings, and it will display an indicator when Recirculation mode is ON and when the A/C is ON.

#### 4. **Right Front Temperature Control**

Provides right front seat occupant with independent temperature control. Turn left for cooler or right for warmer temperature settings.

#### 5. **A/C Button**

Press and release to change the current setting.

#### 6. **Recirculation Mode Button**

Press and release to change the current setting. See Note <sup>1</sup>

**7. Mode Button**

Press the DOWN or UP arrow to change the mode of air distribution to Floor, Panel, Bi-Level, or Mix.

**8. Electric Rear Window Defroster Button**

Refer to “Rear Window Features” in Section 3 for more information.

**9. Defrost Mode Button**

Press and release to select. The indicator illuminates when ON.

**10. Front Blower Button**

Press the DOWN arrow to decrease or the UP arrow to increase blower speed.

**11. AUTO Button**

Controls airflow temperature, distribution, volume, and the amount of air recirculation automatically. Press and release to select. Refer to “Automatic Operation — Two- and Three-Zone ATC” for more information.

**Note**<sup>1</sup> - To prevent window fogging, Recirculation Mode will not operate when either Defrost or Mix mode is selected. Doing so will cause the indicator to blink and then turn OFF.

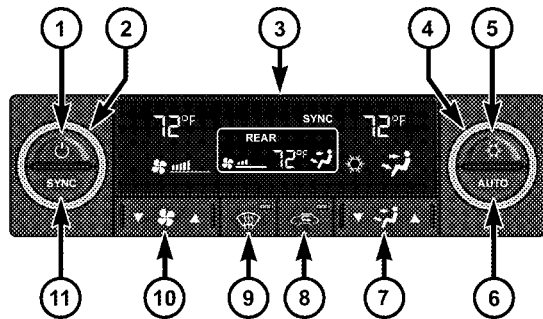

81f4d61d

**1. ATC ON/OFF Button**

Press and release to change the current setting.

## **2. Left Front Temperature Control**

Provides left front seat occupant with independent temperature control. Turn left for cooler or right for warmer temperature settings.

## **3. Display Screen**

Shows the current blower speed, mode, and temperature settings, and it will display an indicator when the A/C is ON.

## **4. Right Front Temperature Control**

Provides right front seat occupant with independent temperature control. Turn left for cooler or right for warmer temperature settings.

## **5. A/C Button**

Press and release to change the current setting.

## **6. AUTO Button**

Controls airflow temperature, distribution, volume, and the amount of air recirculation automatically. Press and

release to select. Refer to “Automatic Operation — Two- and Three-Zone ATC” for more information.

## **7. Mode Button**

Press the DOWN or UP arrow to change the mode of air distribution to Floor, Panel, Bi-Level, or Mix.

## **8. Recirculation Mode Button**

Press and release to change the current setting. The indicator illuminates when ON. See Note <sup>1</sup>

## **9. Defrost Mode Button**

Press and release to select. The indicator illuminates when ON.

## **10. Front Blower Control**

Press the DOWN arrow to decrease or the UP arrow to increase front blower speed.

## **11. SYNC Button**

Press and release to control the temperature setting for all three zones from the Left Front Temperature Control.

**Note**<sup>1</sup> - To prevent window fogging, Recirculation Mode will not operate when either Defrost or Mix mode is selected. Doing so will cause the indicator to blink and then turn OFF.

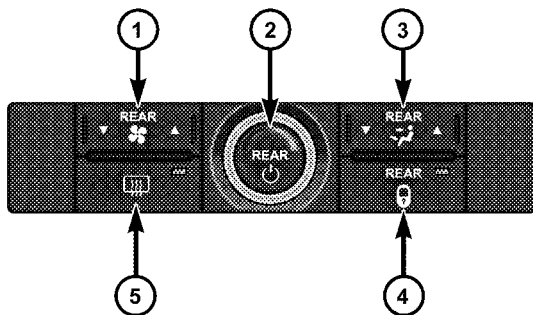

81dc95d4

**Three-Zone ATC Lower Control Panel**

### **1. Rear Blower Control**

Press the DOWN arrow to decrease or the UP arrow to increase rear blower speed.

### **2. Rear Temperature Control**

Provides independent temperature control for the rear cabin. Turn left for cooler or right for warmer temperature settings in the rear cabin.

### **3. Rear Mode Button**

Press the DOWN or UP arrow to change the mode of rear cabin air distribution to Floor, Panel, or Bi-Level.

### **4. REAR Button**

Turns the climate control in the overhead console above the second row passenger seats ON and OFF. Press and release the button to change the current setting. The indicator illuminates when ON.

### **5. Electric Rear Window Defroster Button**

Refer to “Rear Window Features” in Section 3 for more information.

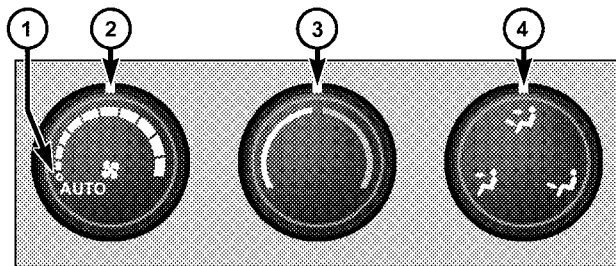

### Rear-Zone ATC

81f4d4f1

The Rear-Zone ATC for the rear passengers is in the overhead console above the second row passenger seats.

#### 1. *AUTO*

Controls airflow temperature, distribution, and volume automatically. Turn to this position to select. Refer to “Automatic Operation — Rear-Zone ATC” for more information.

#### 2. *Rear Blower Control*

The blower speed increases as you move the control to the right from the “O” (Off) position. There are 10 blower speeds.

#### 3. *Rear Temperature Control*

Provides rear seat occupants with independent temperature control. Turn left for cooler or right for warmer temperature settings in the rear cabin.

#### 4. *Rear Mode Control*

Turn to select Panel, Bi-Level, or Floor for the mode of rear cabin air distribution.

#### 5. *Lockout*

This indicator illuminates when the climate control is turned OFF by the REAR button on the Three-Zone ATC in the instrument panel.

**Automatic Operation — Two- and Three-Zone ATC**

The Two- and Three-Zone ATC systems automatically maintain the climate in the cabin of the vehicle. To accomplish this, the system gathers information from the climate controls, from a dual sun-sensor located in the top of the instrument panel, from an infrared sensor located between the sun visors, and from various sensors located throughout the vehicle.

- The climate controls provide the system with operator input.
- The dual sun-sensor monitors sun load coming through the windshield.
- The infrared sensor independently measures the surface temperature of the driver and passengers.
- Other sensors take into account vehicle-speed, A/C pressure, outside temperature, and engine cooling temperature.

Using all of these inputs, the system automatically adjusts airflow temperature, airflow distribution, airflow volume, and the amount of outside air recirculation. This maintains a comfortable temperature even under changing conditions.

To select automatic operation, perform the following steps:

1. Press and release the AUTO button and the ATC displays the word “AUTO,” along with current settings for temperature, mode, and blower speed. It also displays the snowflake icon if the A/C is running.
2. Turn the Left Front Temperature Control, the Right Front, and if so equipped, the Rear Temperature Control to dial in the temperature that you want the system to maintain for each zone. On Three-Zone ATC systems, if so desired, push and release the SYNC button. Then turn



the Left Front Temperature Control to dial in the temperature that you want the system to maintain for all three zones.

Once the comfort level is selected, the system will maintain that level automatically using the heating system. Should the desired comfort level require A/C, the system will automatically make the adjustment. You will experience the greatest efficiency by simply allowing the system to function automatically. 72°F (22°C) is the recommended setting for maximum comfort for the average person; however, this may vary.

**NOTE:**

- The temperature setting can be adjusted at anytime without affecting automatic operation.
- Pressing the A/C button, or adjusting the blower speed, or changing the mode of air distribution while in AUTO mode will cancel automatic operation.

### **Automatic Operation — Rear-Zone ATC**

1. Press the REAR button on the Three-Zone ATC in the instrument panel to turn ON the Rear-Zone ATC in the overhead console.
2. Turn the Rear Blower control on the Rear-Zone ATC in the overhead console to the AUTO position.
3. Turn the Rear Temperature control on the Rear-Zone ATC in the overhead console to dial in the temperature that you want the system to maintain in the rear cabin.

**NOTE:**

- The temperature setting can be adjusted at anytime without affecting automatic operation.

## Operating Tips

**NOTE:** Refer to the chart at the end of this section for suggested control settings for various weather conditions.

### Summer Operation

The engine cooling system in air-conditioned vehicles must be protected with a high-quality antifreeze coolant to provide proper corrosion protection and to protect against engine overheating. Refer to “Cooling System” under “Maintenance Procedures” and to “Fluids, Lubricants, and Genuine Parts” in Section 7 for information pertaining to the cooling system and coolant selection.

### Winter Operation

Use of the air Recirculation mode during Winter months is not recommended because it may cause window fogging.

### Vacation Storage

Anytime you store your vehicle, or keep it out of service (i.e., vacation) for two weeks or more, run the air conditioning system at idle for about five minutes in the fresh air and high blower settings. This will ensure adequate system lubrication to minimize the possibility of compressor damage when the system is started again.

### Window Fogging

Interior fogging on the windshield can be quickly removed by turning the mode selector to Defrost. The Defrost/Floor mode can be used to maintain a clear windshield and provide sufficient heating. If side window fogging becomes a problem, increase blower speed. Vehicle windows tend to fog on the inside in mild but rainy or humid weather.

**NOTE:** Recirculate without A/C should not be used for long periods as fogging may occur.

### **Side Window Demisters**

A side window demister outlet is located at each end of the instrument panel. These non-adjustable outlets direct air toward the side windows when the system is in the Floor, Mix, or Defrost mode. The air is directed at the area of the windows through which you view the outside mirrors.











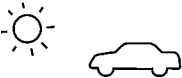









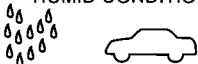

### **Outside Air Intake**

Make sure the air intake, located directly in front of the windshield, is free of obstructions such as leaves. Leaves collected in the air intake may reduce airflow, and if they enter the plenum, they could plug the water drains. In Winter months, make sure the air intake is clear of ice, slush, and snow.

### **A/C Air Filter — If Equipped**

The A/C Air Filter will reduce, but not eliminate, diesel and agricultural smells. The filter acts on air coming from outside the vehicle and recirculated air within the passenger compartment. Refer to “Maintenance Procedures” in Section 7 for A/C Air Filter service information or see your authorized dealer for service. Refer to the Maintenance Schedule in Section 8 for filter service intervals.

## Control Setting Suggestions for Various Weather Conditions

WEATHER	CONTROL SETTINGS
<p>HOT WEATHER AND VEHICLE INTERIOR IS VERY HOT</p> 	<p>Open the windows, start the vehicle, press the  button to turn recirculate off. Set the Fan control to the high position. Press the  button. Set the Mode control at or between  and . Set the temperature control to full cool. After the hot air is pushed from the vehicle press the  button to turn recirculate on and roll up the windows. Once you are comfortable, press the  button to turn recirculate off and adjust the temperature control for comfort.</p>
<p>WARM WEATHER</p> 	<p>Press the  button to turn recirculate off. If it's sunny, set the Mode control at or near  and turn the air conditioning on. If it's cloudy or dark, set the Mode control at or near .</p>
<p>COOL OR COLD HUMID CONDITIONS</p> 	<p>Press the  button to turn recirculate off. If it's sunny, set the Mode control at or between  and  then turn the air conditioning on. If it's cloudy or dark, set the Mode control at or near  and turn the air conditioning on. If the windows begin to fog, set Mode control at or between  and .</p>
<p>COLD DRY CONDITIONS</p> 	<p>Set the Mode control at or near . If it is sunny, you may want more upper air. In this case, set the Mode control at or between  and . In very cold weather, if you need extra heat at the windshield, set the Mode control at or near the .</p>

# STARTING AND OPERATING

## CONTENTS

---

■ Starting Procedures . . . . .	303	■ Automatic Transaxle . . . . .	306
□ Automatic Transaxle . . . . .	304	□ Brake/Transaxle Interlock System . . . . .	307
□ Normal Starting (Tip Start) . . . . .	304	□ Automatic Transaxle Ignition Interlock System . . . . .	308
□ Extremely Cold Weather (Below $-20^{\circ}\text{F}$ Or $-29^{\circ}\text{C}$ ) . . . . .	304	□ 4-Speed Or 6-Speed (AutoStick <sup>®</sup> ) Automatic Transaxle . . . . .	308
□ If Engine Fails To Start . . . . .	305	■ AutoStick <sup>®</sup> — If Equipped . . . . .	312
□ After Starting . . . . .	306	□ AutoStick <sup>®</sup> Operation . . . . .	313
■ Engine Block Heater — If Equipped . . . . .	306	□ AutoStick <sup>®</sup> General Information . . . . .	313

- All Wheel Drive (AWD) — If Equipped . . . . . 314
- Driving On Slippery Surfaces . . . . . 315
  - Acceleration . . . . . 315
  - Traction . . . . . 315
- Driving Through Water . . . . . 316
  - Flowing/Rising Water . . . . . 316
- Parking Brake . . . . . 318
- Brake System . . . . . 321
  - Anti-Lock Brake System (ABS) . . . . . 322
- Electronic Brake Control System . . . . . 323
  - Anti-Lock Brake System (ABS) . . . . . 323
  - Brake Assist System (BAS) . . . . . 325
  - Traction Control System (TCS) . . . . . 326
  - Electronic Roll Mitigation (ERM) . . . . . 326
  - Electronic Stability Program (ESP) . . . . . 327
  - ESP/BAS Warning Light And ESP/TCS Indicator Light . . . . . 329
  - Trailer Sway Control (TSC) . . . . . 330
- Power Steering . . . . . 331
- Tire Safety Information . . . . . 332
  - Tire Markings . . . . . 332
  - Tire Loading And Tire Pressure . . . . . 336
- Tires — General Information . . . . . 340
  - Tire Pressure . . . . . 340
- Tire Chains . . . . . 349
- Snow Tires . . . . . 350

- Tire Pressure Monitor System (TPMS) — If Equipped . . . . . 350
  - Base System — If Equipped . . . . . 353
  - Premium System — If Equipped . . . . . 355
  - General Information . . . . . 358
- Flexible Fuel— 2.7L Engines Only (Except California Emission States) . . . . . 359
  - E-85 General Information . . . . . 359
  - Ethanol Fuel (E-85) . . . . . 360
  - Fuel Requirements for FFV Vehicles . . . . . 360
  - Engine Block Heater (If Equipped) . . . . . 361
  - Selection Of Engine Oil For Flexible Fuel Vehicles (E-85) And Gasoline Vehicles . . . . . 361
  - Starting . . . . . 362
- Cruising Range . . . . . 362
- Replacement Parts . . . . . 362
- Maintenance . . . . . 362
- Fuel Requirements . . . . . 363
  - 2.4L And 2.7L Engines . . . . . 363
  - 3.5L Engine . . . . . 363
  - Reformulated Gasoline . . . . . 364
  - Gasoline/Oxygenate Blends . . . . . 364
  - MMT In Gasoline . . . . . 365
  - Materials Added To Fuel . . . . . 366
  - Fuel System Cautions . . . . . 366
  - Carbon Monoxide Warnings . . . . . 367

- Adding Fuel . . . . . 367
  - Fuel Filler Cap (Gas Cap) . . . . . 367
  - Loose Fuel Filler Cap Message . . . . . 369
- Vehicle Loading . . . . . 370
  - Vehicle Certification Label . . . . . 370
  - Gross Vehicle Weight Rating (GVWR) . . . . . 370
  - Gross Axle Weight Rating (GAWR) . . . . . 370
  - Overloading . . . . . 371
  - Loading . . . . . 371
- Trailer Towing . . . . . 372
  - Common Towing Definitions . . . . . 372
  - Trailer Hitch Classification . . . . . 376
  - Trailer Towing Weights (Maximum Trailer Weight Ratings) . . . . . 377
  - Trailer And Tongue Weight . . . . . 379
  - Towing Requirements . . . . . 380
  - Towing Tips . . . . . 385
- Recreational Towing (Behind Motorhome, Etc.) . . 387
  - Towing This Vehicle Behind Another Vehicle (Flat Towing With All Four Wheels On The Ground) . . . . . 387



## STARTING PROCEDURES

Before starting your vehicle, adjust your seat, adjust the inside and outside mirrors, fasten your seat belt, and if present, instruct all other occupants to buckle their seat belts.

### WARNING!

- **Never leave children alone in a vehicle. Leaving unattended children in a vehicle is dangerous for a number of reasons. A child or others could be seriously or fatally injured. Don't leave the key in the ignition. A child could operate power windows, other controls, or move the vehicle.**
- **Do not leave animals or children inside parked vehicles in hot weather; interior heat buildup may cause serious injury or death.**
- **Be sure to turn OFF the engine and remove the key from the ignition switch if you want to rest or sleep in your car. Accidents can be caused by inadvertently moving the shift lever. Accidents can also be caused by pressing the accelerator pedal. This may cause excessive heat in the exhaust system, resulting in overheating and vehicle fire, which may cause serious or fatal injuries.**

### Automatic Transaxle

The shift lever must be in the NEUTRAL or PARK position before you can start the engine. Apply the brakes before shifting into any driving gear.

#### CAUTION!

**Damage to the transaxle may occur if the following precautions are not observed:**

- **Shift into PARK only after the vehicle has come to a complete stop.**
- **Shift into or out of REVERSE only after the vehicle has come to a complete stop and the engine is at idle speed.**
- **Do not shift from REVERSE, PARK, or NEUTRAL into any forward gear when the engine is above idle speed.**
- **Before shifting into any gear, make sure your foot is firmly on the brake pedal.**

### Normal Starting (Tip Start)

**NOTE:** Normal Starting of either a cold or a warm engine is obtained without pumping or depressing the accelerator pedal.

**Do not** press the accelerator. Use the Fob with Integrated Key to briefly turn the ignition switch to the START position and release it as soon as the starter engages. The starter motor will continue to run, and it will disengage automatically when the engine is running. If the engine fails to start, the starter will disengage automatically in 10 seconds. If this occurs, turn the ignition switch to the LOCK position, wait 10 to 15 seconds, then repeat the normal starting procedure.

### Extremely Cold Weather (Below $-20^{\circ}\text{F}$ or $-29^{\circ}\text{C}$ )

To ensure reliable starting at these temperatures, use of an externally powered electric engine block heater (available from your authorized dealer) is recommended.

## If Engine Fails To Start

### WARNING!

- **Never pour fuel or other flammable liquids into the throttle body air inlet opening in an attempt to start the vehicle. This could result in a flash fire causing serious personal injury.**
- **Do not attempt to push or tow your vehicle to get it started. Vehicles equipped with an automatic transaxle cannot be started this way. Unburned fuel could enter the catalytic converter and once the engine has started, ignite and damage the converter and vehicle. If the vehicle has a discharged battery, booster cables may be used to obtain a start from a booster battery or the battery in another vehicle. This type of start can be dangerous if done improperly. Refer to Section 6 for proper jump-starting procedures and follow them carefully.**

If the engine fails to start after you have followed the “Normal Starting” or “Extreme Cold Weather” procedures, it may be flooded. To clear any excess fuel, push the accelerator pedal all the way to the floor and hold it. Then, turn the ignition switch to the START position and release it as soon as the starter engages. The starter motor will disengage automatically in 10 seconds. Once this occurs, release the accelerator pedal, turn the ignition switch to the LOCK position, wait 10 to 15 seconds, then repeat the normal starting procedure.

### CAUTION!

**To prevent damage to the starter, wait 10 to 15 seconds before trying again.**

### After Starting

The idle speed is controlled automatically and it will decrease as the engine warms up.

### ENGINE BLOCK HEATER — IF EQUIPPED

The engine block heater warms engine coolant and permits quicker starts in cold weather. Connect the cord to a standard 110-115 Volt AC electrical outlet with a grounded, three-wire extension cord.

The engine block heater cord is bundled under the hood between the headlight assembly and the Totally Integrated Power Module (Fuse Box) on the driver's side of the vehicle.

#### **WARNING!**

**Remember to disconnect the cord before driving. Damage to the 110-115 Volt electrical cord could cause electrocution.**

### AUTOMATIC TRANSAXLE

#### **CAUTION!**

**Damage to the transaxle may occur if the following precautions are not observed:**

- **Shift into PARK only after the vehicle has come to a complete stop.**
- **Shift into or out of REVERSE only after the vehicle has come to a complete stop and the engine is at idle speed.**
- **Do not shift from REVERSE, PARK, or NEUTRAL into any forward gear when the engine is above idle speed.**
- **Before shifting into any gear, make sure your foot is firmly on the brake pedal.**

**NOTE:** You **MUST** press and hold the brake pedal down while shifting out of PARK.

**WARNING!**

- **It is dangerous to move the shift lever out of PARK or NEUTRAL if the engine speed is higher than idle speed. If your foot is not firmly on the brake pedal, the vehicle could accelerate quickly forward or in reverse. You could lose control of the vehicle and hit someone or something. Only shift into gear when the engine is idling normally and when your right foot is firmly on the brake pedal.**
- **Unintended movement of a vehicle could injure those in and near the vehicle. As with all vehicles, you should never exit a vehicle while the engine is running. Before exiting a vehicle, you should always shift the vehicle into PARK, remove the key from the ignition, and apply the parking brake. Once the key is removed from the ignition, the shift lever is locked in the PARK position, securing the vehicle against unwanted movement. Furthermore, you should never leave unattended children inside a vehicle.**

**Brake/Transaxle Interlock System**

This vehicle is equipped with a Brake Transaxle Shift Interlock System (BTSI) that holds the shift lever in the PARK position when the ignition switch is in the LOCK position. To move the shift lever out of the PARK position, the ignition switch must be turned to the ON position, and the brake pedal must be depressed.

***BTSI Override***

There is an override for the BTSI that allows you to move the shift lever out of the PARK position if an electrical system malfunction occurs (i.e., dead battery). To activate the override system, perform the following steps:

1. Firmly apply the parking brake.
2. Insert the ignition key into the ignition switch and rotate it to the ON position.
3. Remove the cubby bin liner located in the center console behind the shift lever.

4. Insert a screwdriver or similar small tool into the hole at the front of the cubby bin and push the manual override release lever forward.
5. While holding the release lever forward, move the shift lever from PARK to NEUTRAL.
6. Release the manual override.

#### **Automatic Transaxle Ignition Interlock System**

This system prevents the key from being removed unless the shift lever is in PARK. It also prevents shifting out of PARK unless the key is in the ON position and the brake pedal is applied.

#### **4-Speed or 6-Speed (AutoStick®) Automatic Transaxle**

The electronically controlled transaxle provides a precise shift schedule. The transaxle electronics are self-calibrating; therefore, the first few shifts on a new vehicle

may be somewhat abrupt. This is a normal condition, and precision shifts will develop within a few hundred miles (kilometers).

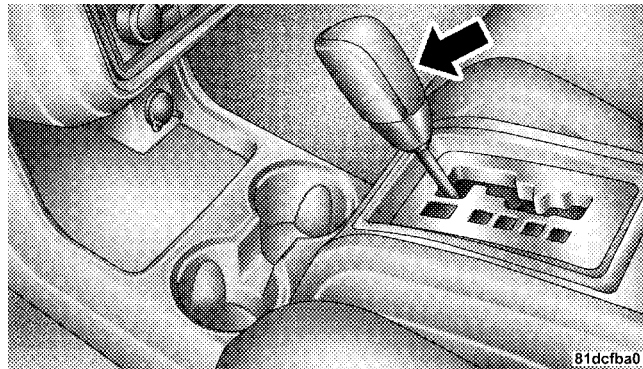

**Shift Lever**

## Gear Ranges

### **PARK**

PARK supplements the parking brake by locking the transaxle. The engine can be started in this range. Never attempt to use PARK while vehicle is in motion. Apply parking brake when leaving vehicle in this range.

When parking on a flat surface, place the shift lever in the PARK position first, and then apply the parking brake.

When parking on a hill, it is important to set the parking brake before placing the shift lever in PARK, otherwise the load on the transaxle locking mechanism may make it difficult to move the shift lever out of PARK. As an added precaution, turn the front wheels toward the curb on a downhill grade and away from the curb on an uphill grade.

### **WARNING!**

**Never use PARK position on an Automatic Transaxle as a substitute for the parking brake. Always apply parking brake fully when parked to guard against vehicle movement and possible injury or damage.**

### **CAUTION!**

**DO NOT race the engine when shifting from PARK or NEUTRAL positions into another gear range as this can damage the drivetrain.**

5

### **REVERSE**

Use REVERSE for moving the vehicle rearward. Shift into REVERSE only after the vehicle has come to a complete stop.

## **NEUTRAL**

The engine may be started in this range.

### **WARNING!**

**Do not coast in NEUTRAL and never turn off the ignition to coast down a hill. These are unsafe practices that limit your response to changing traffic or road conditions. You might lose control of the vehicle and have an accident.**

## **DRIVE — 6-Speed Transaxle**

This range should be used for most city and highway driving. It provides the smoothest upshifts, downshifts, and best fuel economy. However, use the AutoStick® mode and select the “5” range when frequent transaxle shifting occurs while using the DRIVE range, such as when operating the vehicle under heavy loading conditions, (i.e., in hilly terrain, traveling into strong head

winds or while towing heavy trailers). Under these conditions, using the “5” range will improve performance and extend transaxle life by reducing excessive shifting and heat build-up.

## **“D” (Overdrive) — 4-Speed Transaxle**

This range should be used for most city and highway driving. It provides the smoothest upshifts, downshifts, and best fuel economy. However, select the “3” range when frequent transaxle shifting occurs while using the “D” (Overdrive) range, such as when operating the vehicle under heavy loading conditions, (i.e., in hilly terrain, traveling into strong head winds or while towing heavy trailers). Under these conditions, using the “3” range will improve performance and extend transaxle life by reducing excessive shifting and heat build-up.

## **“3” (Drive) — 4-Speed Transaxle**

This range eliminates shifts into “D” (Overdrive). The transaxle will operate normally in 1st, 2nd, and 3rd while



in this range. The “3” (Drive) range should also be used when descending steep grades to prevent brake system distress.

**NOTE:** Using the “3” (Drive) range while operating the vehicle under heavy operating conditions will improve performance and extend transaxle life by reducing excessive shifting and heat build up.

#### ***“L” (Low) — 4-Speed Transaxle***

This range should be used for engine braking when descending very steep grades. In this range, upshifts will occur only to prevent engine overspeed while downshifts occur earlier than other gear range selections.

### **CAUTION!**

**If the transaxle operating temperature exceeds acceptable limits, the vehicle computer will override “D” (Overdrive) and “5” range (for 6-speed AutoStick® transaxle) and “3” range (for 4-speed auto transaxle) by changing shift points. This is done to prevent transaxle damage due to overheating.**

#### **Reset Mode - Electronic Transaxle**

The transaxle is monitored electronically for abnormal conditions. If a condition is detected that could cause damage, the transaxle automatically shifts into 2nd gear (3rd gear for 6-speed). The transaxle remains in 2nd gear (3rd gear for 6-speed) despite the forward gear selected.

PARK, REVERSE, and NEUTRAL will continue to operate. This Reset feature allows the vehicle to be driven to an authorized dealer for service without damaging the transaxle.

In the event of a momentary problem, the transaxle can be reset to regain all forward gears by performing the following steps:

1. Stop the vehicle.
2. Shift into PARK.
3. Turn the ignition switch to the LOCK position.
4. Restart the engine.
5. Shift into the desired gear range and resume driving.

**NOTE:** Even if the transaxle can be reset, it is recommended that you visit an authorized dealer at your

earliest possible convenience. Your authorized dealer has diagnostic equipment to determine if the problem could recur.

If the transaxle cannot be reset, authorized dealer service is required.

### **AUTOSTICK® — IF EQUIPPED**

AutoStick® is a driver-interactive transaxle that offers six manual ratio changes to provide you with more control of the vehicle. AutoStick® allows you to maximize engine braking, eliminate undesirable upshifts and downshifts, and improve overall vehicle performance. This system can also provide you with more control during passing, city driving, cold slippery conditions, mountain driving, trailer towing, and many other situations.

## AutoStick® Operation

By placing the shift lever one shift-level below the DRIVE position, it can be moved from side to side. This allows the driver to select a higher or lower range of gears. Moving the shift lever to the Left (-) triggers a downshift and to the Right (+) an upshift. The gear position will display in the instrument cluster on the transaxle range indicator.

**NOTE:** In Autostick® mode, the transaxle will only shift up or down when the driver moves the shift lever to the Right (+) or Left (-).

AutoStick® is deactivated when the shift lever is moved out of the AutoStick (+/-) position.

## AutoStick® General Information

- You can start out in 1st or 2nd gear. The system will ignore attempts to upshift at too low of a vehicle speed.
- If a ratio other than 1st is selected, and the vehicle is brought to a stop, the transaxle control logic will automatically select the 1st gear ratio.
- Starting out in 2nd gear is helpful in snow or icy conditions.
- Avoid using speed control when Autostick® is engaged.
- The transaxle will automatically shift up when maximum engine speed is reached while Autostick® is engaged.
- Transaxle shifting will be more noticeable when Autostick® is engaged.

- If a low range is selected and the engine accelerates to the rev limit, the transaxle will automatically select the next higher ratio.
- If a downshift would cause the engine to over-speed, that shift will not occur until it is safe for the engine. Mostly the transaxle will stay in the manually selected ratio, however:
  - If the system detects powertrain overheating, the transaxle will revert to the automatic shift mode and remain in that mode until the powertrain cools off.
  - If the system detects a problem, it will disable the AutoStick® mode and the transaxle will return to the automatic mode until the problem is corrected.

#### **ALL WHEEL DRIVE (AWD) — IF EQUIPPED**

This feature provides on-demand All-Wheel Drive (AWD). The system is automatic with no driver inputs or additional driving skills required. Under normal driving conditions, the front wheels provide most of the traction. If the front wheels begin to lose traction, power is shifted automatically to the rear wheels. The greater the front wheel traction loss, the greater the power transfer to the rear wheels.

Additionally, on dry pavement under heavy throttle input (where one may have no wheel spin), torque will be sent to the rear in a pre-emptive effort to improve vehicle launch and performance characteristics.

**CAUTION!**

All wheels must have the same size and type tires. Unequal tire sizes must not be used. Unequal tire size may cause failure of the power transfer unit.

**DRIVING ON SLIPPERY SURFACES****ACCELERATION**

Rapid acceleration on snow covered, wet, or other slippery surfaces may cause the front wheels to pull erratically to the right or left. This phenomenon occurs when there is a difference in the surface traction under the front (driving) wheels.

**WARNING!**

Rapid acceleration on slippery surfaces is dangerous. Unequal traction can cause sudden pulling of the front wheels. You could lose control of the vehicle and possibly have an accident. Accelerate slowly and carefully whenever there is likely to be poor traction (ice, snow, wet, mud, loose sand, etc.).

**TRACTION**

When driving on wet or slushy roads, it is possible for a wedge of water to build up between the tire and road surface. This is hydroplaning and may cause partial or complete loss of vehicle control and stopping ability. To reduce this possibility, the following precautions should be observed:

1. Slow down during rainstorms or when roads are slushy.

2. Slow down if the road has standing water or puddles.
3. Replace the tires when tread wear indicators first become visible.
4. Keep the tires properly inflated.
5. Maintain enough distance between your vehicle and the vehicle in front of you to avoid a collision in a sudden stop.

### **DRIVING THROUGH WATER**

Driving through water more than a few inches/centimeters deep will require extra caution to ensure safety and prevent damage to your vehicle.

### **Flowing/Rising Water**

#### **WARNING!**

**Do not drive on, or cross, a road or a path where water is flowing and/or rising (as in storm run-off). Flowing water can wear away the road or path's surface and cause your vehicle to sink into deeper water. Furthermore, flowing and/or rising water can carry your vehicle away swiftly. Failure to follow this warning may result in injuries that are serious or fatal to you, your passengers, and others around you.**

### **Shallow Standing Water**

Although your vehicle is capable of driving through shallow standing water, consider the following Caution and Warning before doing so.

**CAUTION!**

- Always check the depth of the standing water before driving through it. Never drive through standing water that is deeper than the bottom of the tire rims mounted on the vehicle.
- Determine the condition of the road or the path that is under water, and if there are any obstacles in the way, before driving through the standing water.
- Do not exceed 5 mph (8 km/h) when driving through standing water. This will minimize wave effects.

**CAUTION!**

- Driving through standing water may cause damage to your vehicle's drivetrain components. Always inspect your vehicle's fluids (i.e., engine oil, transmission, axle, etc.) for signs of contamination (i.e., fluid that is milky or foamy in appearance) after driving through standing water. Do not continue to operate the vehicle if any fluid appears contaminated, as this may result in further damage. Such damage is not covered by the New Vehicle Limited Warranty.
- Getting water inside your vehicle's engine can cause it to lock up and stall out, and cause serious internal damage to the engine. Such damage is not covered by the New Vehicle Limited Warranty.

**WARNING!**

- Driving through standing water limits your vehicle's traction capabilities. Do not exceed 5 mph (8 km/h) when driving through standing water.
- Driving through standing water limits your vehicle's braking capabilities, which increases stopping distances. Therefore, after driving through standing water, drive slowly and lightly press on the brake pedal several times to dry the brakes.
- Getting water inside your vehicle's engine can cause it to lock up and stall out, and leave you stranded.
- Failure to follow these warnings may result in injuries that are serious or fatal to you, your passengers, and others around you.

**PARKING BRAKE**

The parking brake should always be applied when the driver is not in the vehicle.

**WARNING!**

Never use **PARK** position on an automatic transaxle as a substitute for the parking brake. Always apply parking brake fully when parked to guard against vehicle movement and possible injury or damage.

When parking on a flat surface, place the shift lever in the **PARK** position first, and then apply the parking brake.



When parking on a hill, it is important to apply the parking brake before placing the shift lever in PARK, otherwise the load on the transaxle locking mechanism may make it difficult to move the shift lever out of PARK. As an added precaution, turn the front wheels toward the curb on a downhill grade and away from the curb on an uphill grade.

The foot operated parking brake is positioned below the lower left corner of the instrument panel. To apply the parking brake, push the parking brake pedal down and then remove your foot from the pedal. To release the parking brake, push down on the parking brake pedal and then release.

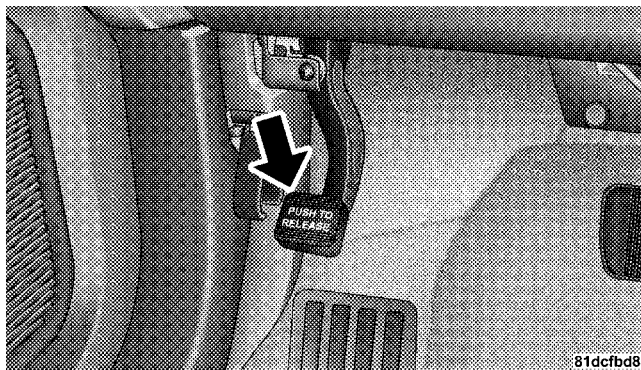

### Parking Brake

The brake light in the instrument cluster will turn on when the parking brake is applied and the ignition switch is in the ON position.

**NOTE:** This light only shows that the parking brake is applied. It does not show the degree of brake application.

**BRAKE** The Brake System Warning Light in the instrument cluster will turn on when the parking brake is applied and the ignition switch is on.

**NOTE:** This light only shows that the parking brake is applied. It does not show the degree of brake application.

### CAUTION!

If the Brake System Warning Light remains on with the parking brake released, a brake system malfunction is indicated. Have the brake system serviced by an authorized dealer immediately.

### WARNING!

- **Never leave children alone in a vehicle. Leaving unattended children in a vehicle is dangerous for a number of reasons. A child or others could be seriously or fatally injured. Don't leave the keys in the ignition. A child could operate power windows, other controls, or move the vehicle.**
- **Be sure the parking brake is fully disengaged before driving: failure to do so can lead to brake failure, and an accident.**

## BRAKE SYSTEM

Your vehicle is equipped with dual hydraulic brake systems. If either of the two hydraulic systems loses normal capability, the remaining system will still function. However, there will be some loss of overall braking effectiveness. This will be evident by increased pedal travel during application and greater pedal force required to slow or stop the vehicle. In addition, if the malfunction is caused by a leak in the hydraulic system, the Brake System Warning Light will turn on as the brake fluid level drops in the master cylinder.

In the event power assist is lost for any reason (i.e., repeated brake applications with the engine OFF) the brakes will still function. However, the effort required to brake the vehicle will be much greater than that required with the power system operating.

### WARNING!

- **Riding the brakes can lead to brake failure and possibly an accident. Driving with your foot resting or riding on the brake pedal can result in abnormally high brake temperatures, excessive lining wear, and possible brake damage. You wouldn't have your full braking capacity in an emergency.**
- **Driving a vehicle with the Brake System Warning Light on is dangerous. A significant decrease in braking performance or vehicle stability during braking may occur. It will take you longer to stop the vehicle or will make your vehicle harder to control. You could have an accident. Have the vehicle checked immediately.**

## Anti-Lock Brake System (ABS)

This system aids the driver in maintaining vehicle control under adverse braking conditions. The system controls hydraulic brake pressure to prevent wheel lock-up to help avoid skidding on slippery surfaces during braking. Refer to “Anti-Lock Brake System (ABS)” under “Electronic Brake Control System” in this section for more information.

### WARNING!

**The ABS cannot prevent the natural laws of physics from acting on the vehicle, nor can it increase the traction afforded by prevailing road conditions. ABS cannot prevent accidents, including those resulting from excessive speed in turns, driving on very slippery surfaces, or hydroplaning. Only a safe, attentive, and skillful driver can prevent accidents. The capabilities of an ABS-equipped vehicle must never be exploited in a reckless or dangerous manner, which could jeopardize the user’s safety or the safety of others.**

## ELECTRONIC BRAKE CONTROL SYSTEM

Your vehicle is equipped with an advanced electronic brake control system commonly referred to as ESP. This system includes Anti-Lock Brake System (ABS), Brake Assist System (BAS), Traction Control System (TCS), Electronic Roll Mitigation (ERM), and Electronic Stability Program (ESP). These systems work together to enhance both vehicle stability and control in various driving conditions.

### Anti-Lock Brake System (ABS)

The Anti-Lock Brake System (ABS) provides increased vehicle stability and brake performance under most braking conditions. The system automatically “pumps” the brakes during severe braking conditions to prevent wheel lock-up.

When the vehicle is driven over 7 mph (11 km/h), you may also hear a slight clicking sound as well as some related motor noises. These noises are the system performing its self check cycle to ensure that the ABS is

working properly. This self check occurs each time the vehicle is started and accelerated past 7 mph (11 km/h).

ABS is activated during braking under certain road or stopping conditions. ABS-inducing conditions can include ice, snow, gravel, bumps, railroad tracks, loose debris, or panic stops.

You also may experience the following when the brake system goes into Anti-lock:

- The ABS motor running (it may continue to run for a short time after the stop),
- The clicking sound of solenoid valves,
- Brake pedal pulsations, and
- A slight drop or fall away of the brake pedal at the end of the stop.

These are all normal characteristics of ABS.

**WARNING!**

- The ABS contains sophisticated electronic equipment that may be susceptible to interference caused by improperly installed or high output radio transmitting equipment. This interference can cause possible loss of anti-lock braking capability. Installation of such equipment should be performed by qualified professionals.
- Pumping of the Anti-Lock Brakes will diminish their effectiveness and may lead to an accident. Pumping makes the stopping distance longer. Just press firmly on your brake pedal when you need to slow down or stop.
- The ABS cannot prevent the natural laws of physics from acting on the vehicle, nor can it increase braking or steering efficiency beyond that afforded by the condition of the vehicle brakes and tires or the traction afforded.
- The ABS cannot prevent accidents, including those resulting from excessive speed in turns, following another vehicle too closely, or hydroplaning. Only a safe, attentive, and skillful driver can prevent accidents.
- The capabilities of an ABS equipped vehicle must never be exploited in a reckless or dangerous manner, which could jeopardize the user's safety or the safety of others.

All vehicle wheels and tires must be the same size and type and tires must be properly inflated to produce accurate signals for the computer.

**Anti-Lock Brake Light**

The Anti-Lock Brake Light monitors the ABS. The light will turn on when the ignition switch is turned to the ON position and may stay on for as long as four seconds.

If the ABS Light remains on or comes on while driving, it indicates that the Anti-Lock portion of the brake system is not functioning and that service is required. However, the conventional brake system will continue to operate normally if the Brake System Warning Light is not on.

If the ABS Light is on, the brake system should be serviced as soon as possible to restore the benefits of Anti-Lock brakes. If the ABS Light does not come on when the ignition switch is turned to the ON position, have the light repaired as soon as possible.

If both the Brake System Warning Light and the ABS Light remain on, the ABS and Electronic Brake Force Distribution (EBD) systems are not functioning. Immediate repair to the ABS system is required.

### **Brake Assist System (BAS)**

The BAS is designed to optimize the vehicle's braking capability during emergency braking maneuvers. The system detects an emergency braking situation by sensing the rate and amount of brake application and then applies optimum pressure to the brakes. This can help reduce braking distances. The BAS complements the ABS. Applying the brakes very quickly results in the best BAS assistance. To receive the benefit of the system, you must apply continuous braking pressure during the stopping sequence, (do not "pump" the brakes). Do not reduce brake pedal pressure unless braking is no longer desired. Once the brake pedal is released, the BAS is deactivated.

### **WARNING!**

**BAS cannot prevent the natural laws of physics from acting on the vehicle, nor can it increase the traction afforded by prevailing road conditions. BAS cannot prevent accidents, including those resulting from excessive speed in turns, driving on very slippery surfaces, or hydroplaning. Only a safe, attentive, and skillful driver can prevent accidents. The capabilities of a BAS-equipped vehicle must never be exploited in a reckless or dangerous manner, which could jeopardize the user's safety or the safety of others.**

### **Traction Control System (TCS)**

This system monitors the amount of wheel spin of each of the driven wheels. If wheel spin is detected, brake pressure is applied to the slipping wheel(s) and engine power is reduced to provide enhanced acceleration and stability. A feature of the TCS functions similar to a limited slip differential and controls the wheel spin across a driven axle. If one wheel on a driven axle is spinning faster than the other, the system will apply the brake of the spinning wheel. This will allow more engine torque to be applied to the wheel that is not spinning. This feature remains active even if TCS and ESP are in the “Partial Off” mode. Refer to “ESP (Electronic Stability Program)” in this section for more information.

### **Electronic Roll Mitigation (ERM)**

This system anticipates the potential for wheel lift by monitoring the driver’s steering wheel input and the speed of the vehicle. When ERM determines that the rate of change of the steering wheel angle and vehicle’s speed are sufficient to potentially cause wheel lift, it then applies the appropriate brake and may also reduce engine power to lessen the chance that wheel lift will occur. ERM will only intervene during very severe or evasive driving maneuvers. ERM can only reduce the chance of wheel lift occurring during severe or evasive driving maneuvers. It cannot prevent wheel lift due to other factors, such as road conditions, leaving the roadway, or striking objects or other vehicles.



**WARNING!**

Many factors, such as vehicle loading, road conditions, and driving conditions, influence the chance that wheel lift or rollover may occur. ERM cannot prevent all wheel lift or rollovers, especially those that involve leaving the roadway or striking objects or other vehicles. Only a safe, attentive, and skillful driver can prevent accidents. The capabilities of an ERM-equipped vehicle must never be exploited in a reckless or dangerous manner, which could jeopardize the user's safety or the safety of others.

**Electronic Stability Program (ESP)**

This system enhances directional control and stability of the vehicle under various driving conditions. ESP corrects for over-steering and under-steering the vehicle by

applying the brake of the appropriate wheel. Engine power may also be reduced to help the vehicle maintain the desired path.

The ESP uses sensors in the vehicle to determine the path that the driver intends to steer the vehicle and compares it to the actual path of the vehicle. When the actual path does not match the intended path, the ESP applies the brake of the appropriate wheel to assist in counteracting the condition of over-steer or under-steer.

- Over-steer - when the vehicle is turning more than appropriate for the steering wheel position.
- Under-steer - when the vehicle is turning less than appropriate for the steering wheel position.

**ESP/TCS Indicator Light**

The ESP/TCS Indicator Light located in the instrument cluster, starts to flash as soon as the tires lose traction and the ESP system becomes

active. The ESP/TCS Indicator Light also flashes when TCS is active. If the ESP/TCS Indicator Light begins to flash during acceleration, ease up on the accelerator and apply as little throttle as possible. Be sure to adapt your speed and driving to the prevailing road conditions.

### **WARNING!**

**ESP cannot prevent the natural laws of physics from acting on the vehicle, nor can it increase the traction afforded by prevailing road conditions. ESP cannot prevent accidents, including those resulting from excessive speed in turns, driving on very slippery surfaces, or hydroplaning. Only a safe, attentive, and skillful driver can prevent accidents. The capabilities of an ESP-equipped vehicle must never be exploited in a reckless or dangerous manner, which could jeopardize the user's safety or the safety of others.**

### **ESP Operating Modes**

The ESP system has two available operating modes.

#### ***Full On***

This is the normal operating mode for ESP. Whenever the vehicle is started the system will be in this mode. This mode should be used for most driving situations. ESP should only be turned to "Partial Off" for specific reasons as noted. Refer to "Partial Off" for additional information.

#### ***Partial Off***

The ESP OFF button is located in the switch bank above the climate Control. To enter the "Partial Off" mode, momentarily depress the ESP OFF button and the ESP/TCS Indicator Light will illuminate. To turn the ESP on again, momentarily depress the ESP OFF button and the ESP/TCS Indicator Light will turn off. This will restore the normal "ESP On" mode of operation.

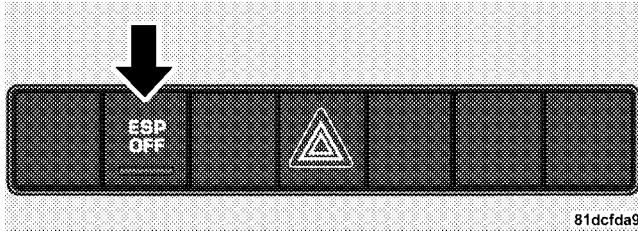

**ESP OFF Button**

**NOTE:** To improve the vehicle's traction when driving with snow chains, or when starting off in deep snow, sand, or gravel, it may be desirable to switch to the "Partial Off" mode by momentarily depressing the ESP OFF button. Once the situation requiring "Partial Off" mode is overcome, turn ESP back on by momentarily depressing the ESP OFF button. This may be done while the vehicle is in motion.

## ESP/BAS Warning Light and ESP/TCS Indicator Light

### ESP BAS

The malfunction indicator for the ESP is combined with the BAS indicator. The ESP/BAS Malfunction Indicator Light and the ESP/TCS Indicator Light in the instrument cluster both turn on when the ignition switch is turned to the ON position. They should both turn off with the engine running. If the ESP/BAS Malfunction Indicator Light turns on continuously with the engine running, a malfunction has been detected in either the ESP or the BAS system, or both. If this light remains on after several ignition cycles, and the vehicle has been driven several miles (kilometers) at speeds greater than 30 mph (48 km/h), see your authorized dealer as soon as possible to have the problem diagnosed and corrected.

**NOTE:**

- "The ESP/TCS Indicator Light and the ESP/BAS Malfunction Indicator Light will turn on momentarily each time the ignition switch is turned ON.
- Each time the ignition is turned ON, the ESP System will be ON even if it was turned off previously.
- The ESP Control System will make buzzing or clicking sounds when it is active. This is normal; the sounds will stop when ESP becomes inactive following the maneuver that caused the ESP activation.

**Trailer Sway Control (TSC)**

TSC uses sensors in the vehicle to recognize an excessively swaying trailer. TSC activates automatically once the excessively swaying trailer is recognized. When TSC is functioning, the ESP/TCS Indicator Light will flash, the engine power will be reduced, and you will feel the brake being applied to individual wheels in an attempt to stop the trailer from swaying.

**NOTE:** The TSC is disabled when the ESP system is in the "Partial Off" mode.

**WARNING!**

- **TSC cannot stop all trailers from swaying. Always use caution when towing a trailer and follow the tongue weight recommendations. Refer to "Vehicle Loading" and "Trailer Towing" in this section for more information before towing a trailer with your vehicle.**
- **If TSC activates while towing a trailer, stop the vehicle at the nearest safe location and adjust the trailer load to eliminate the trailer sway.**
- **Failure to follow these warnings can result in an accident or serious personal injury.**

## POWER STEERING

The standard power steering system will give you good vehicle response and increased ease of maneuverability in tight spaces. The system will provide mechanical steering capability if power assist is lost.

If for some reason the power assist is interrupted, it will still be possible to steer your vehicle. Under these conditions, you will observe a substantial increase in steering effort, especially at very low vehicle speeds and during parking maneuvers.

**NOTE:** Increased noise levels at the end of the steering wheel travel are considered normal and do not indicate that there is a problem with the power steering system.

Upon initial start-up in cold weather, the power steering pump may make noise for a short amount of time. This is due to the cold, thick fluid in the steering system. This noise should be considered normal, and it does not in any way damage the steering system.

### WARNING!

**Continued operation with reduced power steering assist could pose a safety risk to yourself and others. Service should be obtained as soon as possible.**

### CAUTION!

**Prolonged operation of the steering system at the end of the steering wheel travel will increase the steering fluid temperature and it should be avoided when possible. Damage to the power steering pump may occur.**

## TIRE SAFETY INFORMATION

## TIRE MARKINGS

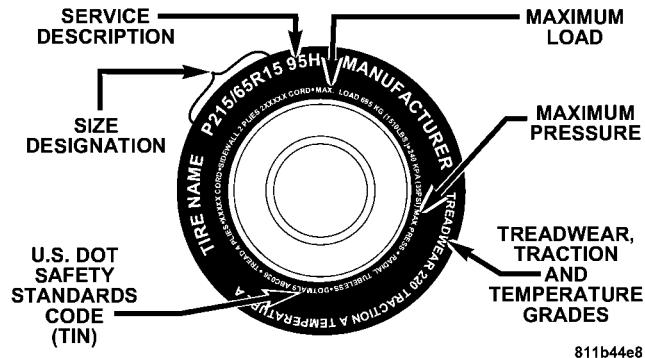

## NOTE:

- P (Passenger) - Metric tire sizing is based on U.S. design standards. P-Metric tires have the letter "P" molded into the sidewall preceding the size designation. Example: P215/65R15 95H.

- European-Metric tire sizing is based on European design standards. Tires designed to this standard have the tire size molded into the sidewall beginning with the section width. The letter "P" is absent from this tire size designation. Example: 215/65R15 96H.
- LT (Light Truck) - Metric tire sizing is based on U.S. design standards. The size designation for LT-Metric tires is the same as for P-Metric tires except for the letters "LT" that are molded into the sidewall preceding the size designation. Example: LT235/85R16.
- Temporary spare tires are high-pressure compact spares designed for temporary emergency use only. Tires designed to this standard have the letter "T" molded into the sidewall preceding the size designation. Example: T145/80D18 103M.
- High flotation tire sizing is based on U.S. design standards, and it begins with the tire diameter molded into the sidewall. Example: 31x10.5 R15 LT.

## Tire Sizing Chart

<b>TIRE SIZING TERMS</b>	
<b>Size Designation:</b>	
<b>P</b>	= Passenger Car tire size based on U.S. design standards
<b>"...blank..."</b>	= Passenger Car tire based on European design standards
<b>LT</b>	= Light Truck tire based on U.S. design standards
<b>T</b>	= Temporary spare tire
<b>31</b>	= Overall diameter in inches (in)
<b>215</b>	= Section width in millimeters (mm)
<b>65</b>	= Aspect ratio in percent (%) — Ratio of section height to section width of tire
<b>10.5</b>	= Section width in inches (in)
<b>R</b>	= Construction code — "R" means radial construction — "D" means diagonal or bias construction
<b>15</b>	= Rim diameter in inches (in)

## TIRE SIZING TERMS

### Service Description:

**95** = Load Index

— A numerical code associated with the maximum load a tire can carry

**H** = Speed Symbol

— A symbol indicating the range of speeds at which a tire can carry a load corresponding to its load index under certain operating conditions

— The maximum speed corresponding to the speed symbol should only be achieved under specified operating conditions (i.e., tire pressure, vehicle loading, road conditions, and posted speed limits)

### Load Identification:

"...**blank**..." = Absence of any text on the sidewall of the tire indicates a Standard Load (SL) Tire

**Extra Load (XL)** = Extra load (or reinforced) tire

**Light Load** = Light load tire

**C, D, E** = Load range associated with the maximum load a tire can carry at a specified pressure

**Maximum Load** — Maximum load indicates the maximum load this tire is designed to carry

**Maximum Pressure** — Maximum pressure indicates the maximum permissible cold tire inflation pressure for this tire



**TIRE IDENTIFICATION NUMBER (TIN)**

The TIN may be found on one or both sides of the tire, however, the date code may only be on one side. Tires with white sidewalls will have the full TIN, including the date code, located on the white sidewall side of the tire.

Look for the TIN on the outboard side of black sidewall tires as mounted on the vehicle. If the TIN is not found on the outboard side, then you will find it on the inboard side of the tire.

<b>TIRE IDENTIFICATION NUMBER</b>
<b>EXAMPLE: DOT MA L9 ABCD 0301</b>
<b>DOT</b> = Department of Transportation — This symbol certifies that the tire is in compliance with the U.S. Department of Transportation tire safety standards, and is approved for highway use
<b>MA</b> = Code representing the tire manufacturing location (two digits)
<b>L9</b> = Code representing the tire size (two digits)
<b>ABCD</b> = Code used by the tire manufacturer (one to four digits)
<b>03</b> = Number representing the week in which the tire was manufactured (two digits) —03 means the 3rd week.
<b>01</b> = Number representing the year in which the tire was manufactured (two digits) —01 means the year 2001 — Prior to July 2000, tire manufacturers were only required to have one number to represent the year in which the tire was manufactured. Example: 031 could represent the 3rd week of 1981 or 1991

## TIRE LOADING AND TIRE PRESSURE

### Tire Placard Location

**NOTE:** The proper cold tire inflation pressure is listed on either the face of the driver's door or the driver's side B-Pillar.

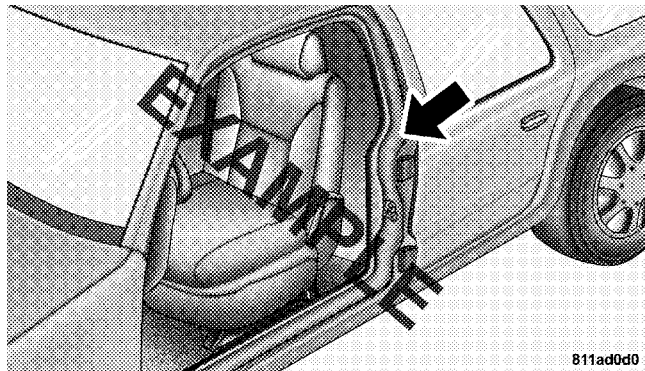

**Tire Placard Location**

### Tire and Loading Information Placard

TIRE AND LOADING INFORMATION			
SEATING CAPACITY - TOTAL 5		FRONT 2	REAR 3
THE COMBINED WEIGHT OF OCCUPANTS AND CARGO SHOULD NEVER EXCEED XXX KG OR XXX LBS.			
TIRE	FRONT	REAR	SPARE
ORIGINAL TIRE SIZE	P195/70R14	P195/70R14	T125/70D15
COLD TIRE INFLATION PRESSURE	200kPa, 29PSI	200kPa, 29PSI	420kPa, 60PSI
SEE OWNER'S MANUAL FOR ADDITIONAL INFORMATION			4N109268

### Tire and Loading Information Placard 811b5a9a

This placard tells you important information about the:

- 1) number of people that can be carried in the vehicle
- 2) total weight your vehicle can carry
- 3) tire size designed for your vehicle
- 4) cold tire inflation pressures for the front, rear, and spare tires.

## Loading

The vehicle maximum load on the tire must not exceed the load carrying capacity of the tire on your vehicle. You will not exceed the tire's load carrying capacity if you adhere to the loading conditions, tire size, and cold tire inflation pressures specified on the Tire and Loading Information placard and in the "Vehicle Loading" section of this manual.

**NOTE:** Under a maximum loaded vehicle condition, gross axle weight ratings (GAWRs) for the front and rear axles must not be exceeded. For further information on GAWRs, vehicle loading, and trailer towing, refer to "Vehicle Loading" in this section.

To determine the maximum loading conditions of your vehicle, locate the statement "The combined weight of

occupants and cargo should never exceed XXX kg or XXX lbs." on the Tire and Loading Information placard. The combined weight of occupants, cargo/luggage and trailer tongue weight (if applicable) should never exceed the weight referenced here.

### *Steps for Determining Correct Load Limit*

1. Locate the statement "The combined weight of occupants and cargo should never exceed XXX kg or XXX lbs" on your vehicle's placard.
2. Determine the combined weight of the driver and passengers that will be riding in your vehicle.
3. Subtract the combined weight of the driver and passengers from XXX kg or XXX lbs.

4. The resulting figure equals the available amount of cargo and luggage load capacity. For example, if “XXX” amount equals 1,400 lbs (635 kg) and there will be five 150 lb (68 kg) passengers in your vehicle, the amount of available cargo and luggage load capacity is 650 lbs (295 kg) (since  $5 \times 150 = 750$ , and  $1400 - 750 = 650$  lbs [295 kg]).
5. Determine the combined weight of luggage and cargo being loaded on the vehicle. That weight may not safely exceed the available cargo and luggage load capacity calculated in Step 4.
6. If your vehicle will be towing a trailer, load from your trailer will be transferred to your vehicle. Consult this

manual to determine how this reduces the available cargo and luggage load capacity of your vehicle.

**NOTE:** The following table shows examples on how to calculate total load, cargo/luggage, and towing capacities of your vehicle with varying seating configurations and number and size of occupants. This table is for illustration purposes only and may not be accurate for the seating and load carry capacity of your vehicle.

**NOTE:** For the following example, the combined weight of occupants and cargo should never exceed 865 lbs (392 kg).

Occupants			Combined weight of occupants and cargo from Tire Placard	MINUS	Combined Occupant's weight	=	AVAILABLE Cargo/Luggage and Trailer Tongue Weight
TOTAL	FRONT	REAR					
<u>EXAMPLE 1</u>			865 lbs	minus	670 lbs	=	195 lbs
5	2	3					
<u>EXAMPLE 2</u>			865 lbs	minus	540 lbs	=	325 lbs
3	2	1					
<u>EXAMPLE 3</u>			865 lbs	minus	400 lbs	=	465 lbs
2	2	0					

811a4d11

**WARNING!**

Overloading of your tires is dangerous. Overloading can cause tire failure, affect vehicle handling, and increase your stopping distance. Use tires of the recommended load capacity for your vehicle. Never overload them.

**TIRES — GENERAL INFORMATION****Tire Pressure**

Proper tire inflation pressure is essential to the safe and satisfactory operation of your vehicle. Three primary areas are affected by improper tire pressure:

**1. Safety—****WARNING!**

- Improperly inflated tires are dangerous and can cause accidents.
- Under-inflation increases tire flexing and can result in tire failure.

**WARNING!**

- Over-inflation reduces a tire's ability to cushion shock. Objects on the road and chuckholes can cause damage that result in tire failure.
- Over-inflated or under-inflated tires can affect vehicle handling and can fail suddenly, resulting in loss of vehicle control.

**WARNING!**

- **Unequal tire pressures can cause steering problems. You could lose control of your vehicle.**
- **Unequal tire pressures from one side of the vehicle to the other can cause the vehicle to drift to the right or left.**
- **Always drive with each tire inflated to the recommended cold tire inflation pressure.**

**2. Economy—**

Improper inflation pressures can cause uneven wear patterns to develop across the tire tread. These abnormal wear patterns will reduce tread life resulting in a need for earlier tire replacement. Under-inflation also increases tire rolling resistance and results in higher fuel consumption.

**3. Ride Comfort and Vehicle Stability—**

Proper tire inflation contributes to a comfortable ride. Over-inflation produces a jarring and uncomfortable ride.

**Tire Inflation Pressures**

The proper cold tire inflation pressure is listed either on the face of the driver's door or on the driver's side "B" pillar.

Some vehicles may have Supplemental Tire Pressure Information for vehicle loads that are less than the maximum loaded vehicle condition. These pressure conditions will be found in the "Supplemental Tire Pressure Information" section of this manual.

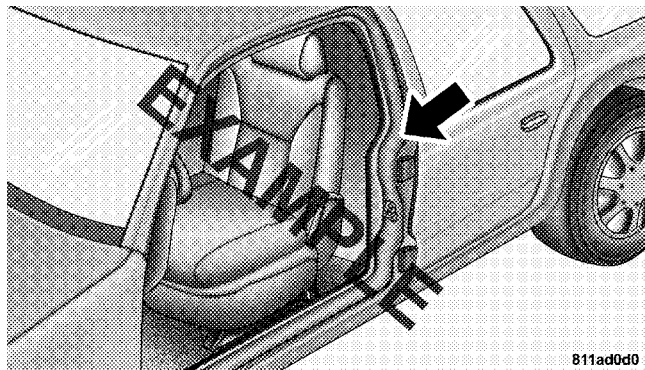

#### Tire Placard Location

The pressure should be checked and adjusted as well as inspecting for signs of tire wear or visible damage at least once a month. Use a good quality pocket-type gauge to check tire pressure. **DO NOT** make a visual judgement when determining proper inflation. Radial tires may look properly inflated even when they are under-inflated.

#### CAUTION!

After inspecting or adjusting the tire pressure, always reinstall the valve stem cap (if equipped). This will prevent moisture and dirt from entering the valve stem, which could damage the valve stem.

Inflation pressures specified on the placard are always “cold tire inflation pressure.” Cold tire inflation pressure is defined as the tire pressure after the vehicle has not been driven for at least three hours, or driven less than 1 mi (1.6 km) after a three hour period. The cold tire inflation pressure must not exceed the maximum inflation pressure molded into the tire sidewall.

Check tire pressures more often if subject to a wide range of outdoor temperatures, as tire pressures vary with temperature changes.



Tire pressures change by approximately 1 psi (7 kPa) per 12°F (7°C) of air temperature change. Keep this in mind when checking tire pressure inside a garage, especially in the Winter.

Example: If garage temperature = 68°F (20°C) and the outside temperature = 32°F (0°C) then the cold tire inflation pressure should be increased by 3 psi (21 kPa), which equals 1 psi (7 kPa) for every 12°F (7°C) for this outside temperature condition.

Tire pressure may increase from 2 to 6 psi (13 to 40 kPa) during operation. DO NOT reduce this normal pressure build up or your tire pressure will be too low.

### **Tire Pressures for High Speed Operation**

The manufacturer advocates driving at safe speeds within posted speed limits. Where speed limits or conditions are such that the vehicle can be driven at high speeds, maintaining correct tire inflation pressure is very important. Increased tire pressure and reduced vehicle

loading may be required for high-speed vehicle operation. Refer to original equipment or an authorized tire dealer for recommended safe operating speeds, loading and cold tire inflation pressures.

#### **WARNING!**

**High speed driving with your vehicle under maximum load is dangerous. The added strain on your tires could cause them to fail. You could have a serious accident. Don't drive a vehicle loaded to the maximum capacity at continuous speeds above 75 mph (120 km/h).**

## Radial Ply Tires

### **WARNING!**

**Combining radial ply tires with other types of tires on your vehicle will cause your vehicle to handle poorly. The instability could cause an accident. Always use radial ply tires in sets of four (or six, in case of trucks with dual rear wheels). Never combine them with other types of tires.**

Cuts and punctures in radial tires are repairable only in the tread area because of sidewall flexing. Consult your authorized tire dealer for radial tire repairs.

### **Compact Spare Tire — If Equipped**

The compact spare is for temporary emergency use with radial tires. It is engineered to be used on your style

vehicle only. Since this tire has limited tread life, the original tire should be repaired (or replaced) and reinstalled at the first opportunity.

### **WARNING!**

- **Temporary use spare tires are for emergency use only. With these tires, DO NOT drive more than 50 mph (80 km/h).**
- **Temporary-use spare tires have limited tread life. When the tread is worn to the tread wear indicators, the temporary use spare tire needs to be replaced.**
- **Be sure to follow the warnings, which apply to your spare. Failure to do so could result in spare tire failure and loss of vehicle control.**

DO NOT install a wheel cover or attempt to mount a conventional tire on the compact spare wheel, since the wheel is designed specifically for the compact spare.

DO NOT install more than one compact spare tire/wheel on the vehicle at any given time.

### CAUTION!

**Because of the reduced ground clearance, DO NOT take your vehicle through an automatic car wash with the compact spare installed. Damage to the vehicle may result.**

### Limited-Use Spare — If Equipped

The limited-use spare tire is for temporary emergency use on your vehicle. This tire is identified by a limited-use spare tire warning label located on the limited-use spare tire and wheel assembly. This tire may look like the

original equipped tire on the front or rear axle of your vehicle, but it is not. Installation of this limited-use spare tire affects vehicle handling. Since it is not the same tire, replace (or repair) the original tire and reinstall on the vehicle at the first opportunity.

### WARNING!

**The limited-use spare tires are for emergency use only. Installation of this limited-use spare tire affects vehicle handling. With this tire, DO NOT drive more than 50 mph (80 km/h). Keep inflated to the cold tire inflation pressure listed on either your tire placard or limited-use spare tire and wheel assembly. Replace (or repair) the original tire at the first opportunity and reinstall it on your vehicle. Failure to do so could result in loss of vehicle control.**

## Tire Spinning

When stuck in mud, sand, snow, or ice conditions, **DO NOT** spin your vehicle's wheels faster than 30 mph (48 km/h) or for longer than 30 seconds continuously without stopping when you are stuck.

For additional information, refer to "Freeing A Stuck Vehicle" in Section 6.

### WARNING!

**Fast spinning tires can be dangerous. Forces generated by excessive wheel speeds may cause tire damage or failure. A tire could explode and injure someone. DO NOT spin your vehicle's wheels faster than 30 mph (48 km/h) or for more than 30 seconds continuously when you are stuck, and don't let anyone near a spinning wheel, no matter what the speed.**

## Tread Wear Indicators

Tread wear indicators are in the original equipment tires to help you in determining when your tires should be replaced.

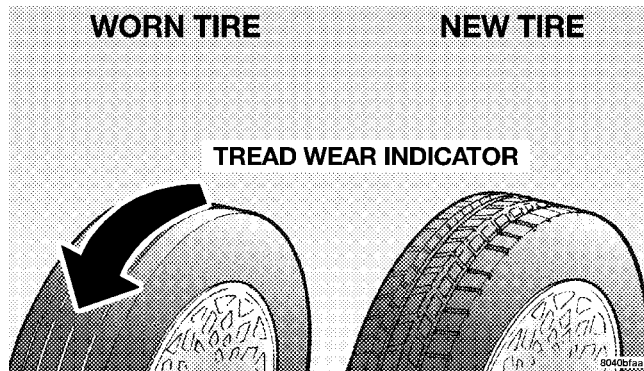

These indicators are molded into the bottom of the tread grooves. They will appear as bands when the tread depth becomes 1/16 in (2 mm). When the tread is worn to the tread wear indicators, the tire should be replaced.

Many states have laws requiring tire replacement at this point.

### **Life of Tire**

The service life of a tire is dependent upon varying factors including, but not limited to:

- Driving style
- Tire pressure
- Distance driven

### **WARNING!**

**Tires and the spare tire should be replaced after six years, regardless of the remaining tread. Failure to follow this warning can result in sudden tire failure. You could lose control and have an accident resulting in serious injury or death.**

Keep dismounted tires in a cool, dry place with as little exposure to light as possible. Protect tires from contact with oil, grease, and gasoline.

### **Replacement Tires**

The tires on your new vehicle provide a balance of many characteristics. They should be inspected regularly for wear and correct cold tire inflation pressure. The manufacturer strongly recommends that you use tires equivalent to the originals in size, quality and performance when replacement is needed. (Refer to the paragraph on “Tread Wear Indicators”). Refer to the “Tire and Loading Information” placard for the size designation of your tire. The service description and load identification will be found on the original equipment tire. Failure to use equivalent replacement tires may adversely affect the safety, handling, and ride of your vehicle. We recommend that you contact your original equipment or an authorized tire dealer with any questions you may have on tire specifications or capability.

**WARNING!**

**DO NOT** use a tire, wheel size or rating other than that specified for your vehicle. Some combinations of unapproved tires and wheels may change suspension dimensions and performance characteristics, resulting in changes to steering, handling, and braking of your vehicle. This can cause unpredictable handling and stress to steering and suspension components. You could lose control and have an accident resulting in serious injury or death. Use only the tire and wheel sizes with load ratings approved for your vehicle.

**WARNING!**

- **NEVER** use a tire with a smaller load index or capacity, other than what was originally equipped on your vehicle. Using a tire with a smaller load index could result in tire overloading and failure. You could lose control and have an accident.
- Failure to equip your vehicle with tires having adequate speed capability can result in sudden tire failure and loss of vehicle control.

**CAUTION!**

Replacing original tires with tires of a different size may result in false speedometer and odometer readings.

## Alignment And Balance

Poor suspension alignment may result in:

- Fast tire wear.
- Uneven tire wear, such as feathering and one-sided wear.
- Vehicle pull to right or left.

Tires may also cause the vehicle to pull to the left or right. Alignment will not correct this condition. See your authorized dealer for proper diagnosis.

Improper alignment will not cause vehicle vibration. Vibration may be a result of tire and wheel out-of-balance. Proper balancing will reduce vibration and avoid tire cupping and spotty wear.

## TIRE CHAINS

Due to limited clearance, tire chains are not recommended.

### CAUTION!

**Damage to the vehicle may result if tire chains are used.**

## SNOW TIRES

Some areas of the country require the use of snow tires during the winter. Standard tires are of the all season type and satisfy this requirement as indicated by the M+S designation on the tire sidewall.

If you need snow tires, select tires equivalent in size and type to the original equipment tires. Use snow tires only in sets of four. Failure to do so may adversely affect the safety and handling of your vehicle.

Snow tires generally have lower speed ratings than what was originally equipped with your vehicle and should not be operated at sustained speeds over 75 mph (120 km/h).

## TIRE PRESSURE MONITOR SYSTEM (TPMS) — IF EQUIPPED

- The Tire Pressure Monitor System (TPMS) will warn the driver of a low tire pressure based on the vehicle recommended cold placard pressure.
- The tire pressure will vary with temperature by about 1 psi (6.9 kPa) for every 12°F (6.5°C). This means that when the outside temperature decreases, the tire pressure will decrease. Tire pressure should always be set based on cold inflation tire pressure. This is defined as the tire pressure after the vehicle has not been driven for at least three hours, or driven less than 1 mi (1 km) after a three hour period. The cold tire inflation pressure must not exceed the maximum inflation pressure molded into the tire sidewall. Refer to the “Tires – General Information” in this section for information on how to properly inflate the vehicle’s tires.



The tire pressure will also increase as the vehicle is driven. This is normal and there should be no adjustment for this increased pressure.

- The TPMS will warn the driver of a low tire pressure if the tire pressure falls below the low-pressure warning limit for any reason, including low temperature effects and natural pressure loss through the tire.
- The TPMS will continue to warn the driver of low tire pressure as long as the condition exists, and will not turn off until the tire pressure is at or above the recommended cold placard pressure. Once the low tire pressure warning (Tire Pressure Monitoring Telltale light) illuminates, you must increase the tire pressure to the recommended cold placard pressure in order for the Tire Pressure Monitoring Telltale light to turn off. The system will automatically update and the Tire Pressure Monitoring Telltale light will turn off once the system receives the updated tire pressures. The vehicle

may need to be driven for up to 10 minutes above 15 mph (25 km/h) in order for the TPMS to receive this information.

- For example, your vehicle may have a recommended cold (parked for more than three hours) placard pressure of 33 psi (227 kPa). If the ambient temperature is 68°F (20°C) and the measured tire pressure is 28 psi (193 kPa), a temperature drop to 20°F (-7°C) will decrease the tire pressure to approximately 24 psi (165 kPa). This tire pressure is low enough to turn ON the Tire Pressure Monitoring Telltale light. Driving the vehicle may cause the tire pressure to rise to approximately 28 psi (193 kPa), but the Tire Pressure Monitoring Telltale light will still be on. In this situation, the Tire Pressure Monitoring Telltale light will turn off only after the tires are inflated to the vehicle's recommended cold placard pressure value.

**CAUTION!**

- **The TPMS has been optimized for the original equipment tires and wheels. TPMS pressures and warning have been established for the tire size equipped on your vehicle. Undesirable system operation or sensor damage may result when using replacement equipment that is not of the same size, type, and/or style. Aftermarket wheels can cause sensor damage. Do not use aftermarket tire sealants or balance beads if your vehicle is equipped with a TPMS, as damage to the sensors may result.**
- **After inspecting or adjusting the tire pressure, always reinstall the valve stem cap. This will prevent moisture and dirt from entering the valve stem, which could damage the Tire Pressure Monitoring Sensor.**

**NOTE:**

- The TPMS is not intended to replace normal tire care and maintenance, or to provide warning of a tire failure or condition.
- The TPMS should not be used as a tire pressure gauge while adjusting your tire pressure.
- Driving on a significantly under-inflated tire causes the tire to overheat and can lead to tire failure. Under-inflation also reduces fuel efficiency and tire tread life, and may affect the vehicle's handling and stopping ability.
- The TPMS is not a substitute for proper tire maintenance, and it is the driver's responsibility to maintain correct tire pressure using an accurate tire pressure gauge, even if under-inflation has not reached the level to trigger illumination of the Tire Pressure Monitoring Telltale light.

- Seasonal temperature changes will affect tire pressure, and the TPMS will monitor the actual tire pressure in the tire.

### Base System — If Equipped

The Tire Pressure Monitor System (TPMS) uses wireless technology with wheel rim mounted electronic sensors to monitor tire pressure levels. Sensors, mounted to each wheel as part of the valve stem, transmit tire pressure readings to the receiver module.

**NOTE:** It is particularly important for you to check the tire pressure in all of the tires on your vehicle monthly and to maintain the proper pressure.

The TPMS consists of the following components:

- Receiver Module
- Four Tire Pressure Monitoring Sensors
- Tire Pressure Monitoring Telltale light

### Tire Pressure Monitoring Low Pressure Warnings



The Tire Pressure Monitoring Telltale light will illuminate in the instrument cluster and a chime will sound when tire pressure is low in one or more of the four active road tires. Should this occur, you should stop as soon as possible, check the inflation pressure of each tire on your vehicle, and inflate each tire to the vehicle's recommended cold placard pressure value. Once the system receives the updated tire pressures, the system will automatically update and the Tire Pressure Monitoring Telltale light will turn off. The vehicle may need to be driven for up to 10 minutes above 15 mph (25 km/h) in order for the TPMS to receive this information.

### Check TPMS Warning

When a system fault is detected, the Tire Pressure Monitoring Telltale light will flash on and off for 75 seconds and then remain on solid. The system fault will also sound a chime. If the ignition key is cycled, this sequence

will repeat, providing the system fault still exists. The Tire Pressure Monitoring Telltale light will turn off when the fault condition no longer exists. A system fault can occur due to any of the following:

1. Jamming due to electronic devices or driving next to facilities emitting the same Radio Frequencies as the TPMS sensors.
2. Installing some form of aftermarket window tinting that affects radio wave signals.
3. Lots of snow or ice around the wheels or wheel housings.
4. Using tire chains on the vehicle.
5. Using wheels/tires not equipped with TPMS sensors.

**NOTE:**

1. The compact spare tire does not have a tire pressure monitoring sensor. Therefore, the TPMS will not monitor the pressure in the compact spare tire.
2. If you install the compact spare tire in place of a road tire that has a pressure below the low-pressure warning limit, a chime will sound and the TPMS Telltale light will turn on upon the next ignition key cycle.
3. After driving the vehicle for up to 10 minutes above 15 mph (25 km/h), the TPMS Telltale light will flash on and off for 75 seconds and then remain on solid.
4. For each subsequent ignition key cycle, a chime will sound and the TPMS Telltale light will flash on and off for 75 seconds and then remain on solid.

5. Once you repair or replace the original road tire and reinstall it on the vehicle in place of the compact spare, the TPMS will update automatically and the TPMS Telltale light will turn off, as long as no tire pressure is below the low-pressure warning limit in any of the four active road tires. The vehicle may need to be driven for up to 10 minutes above 15 mph (25 km/h) in order for the TPMS to receive this information.

#### **Premium System — If Equipped**

The Tire Pressure Monitor System (TPMS) uses wireless technology with wheel rim mounted electronic sensors to monitor tire pressure levels. Sensors, mounted to each wheel as part of the valve stem, transmit tire pressure readings to the receiver module.

**NOTE:** It is particularly important for you to check the tire pressure in all of the tires on your vehicle monthly and to maintain the proper pressure.

The TPMS consists of the following components:

- Receiver module
- Four Tire Pressure Monitoring Sensors
- Three Trigger modules (mounted in three of the four wheel-wells)
- Various Tire Pressure Monitoring System messages, which display in the Electronic Vehicle Information Center (EVIC)
- Tire Pressure Monitoring Telltale light

#### **Tire Pressure Monitoring Low Pressure Warnings**



The Tire Pressure Monitoring Telltale light will illuminate in the instrument cluster and a chime will sound when tire pressure is low in one or more of the four active road tires. In addition, the

Electronic Vehicle Information Center (EVIC) will display a graphic showing the pressure values of each tire with the low tire pressure values flashing.

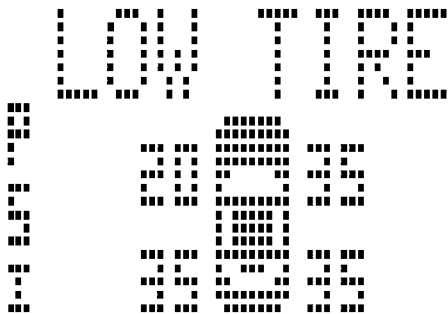

81826bed

Should this occur, you should stop as soon as possible and inflate the tires with low pressure (those flashing in the EVIC graphic) to the vehicle's recommended cold placard pressure value. Once the system receives the updated tire pressures, the system will automatically update, the graphic display in the EVIC will stop flashing, and the Tire Pressure Monitoring Telltale light will turn off. The vehicle may need to be driven for up to 10 minutes above 15 mph (25 km/h) in order for the TPMS to receive this information.

### Check TPMS Warning

When a system fault is detected, the Tire Pressure Monitoring Telltale light will flash on and off for 75 seconds and then remain on solid. The system fault will also sound a chime. In addition, the EVIC will display a "CHECK TPM SYSTEM" message for three seconds and then display dashes (- -) in place of the pressure value to indicate which sensor is not being received.

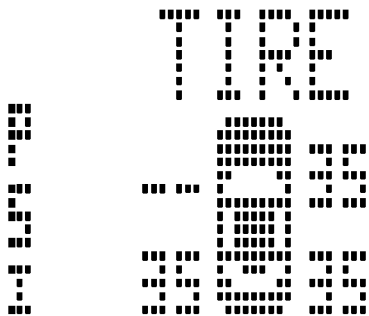

81826bd7

If the ignition key is cycled, this sequence will repeat, providing the system fault still exists. If the system fault no longer exists, the Tire Pressure Monitoring Telltale light will no longer flash, and the "CHECK TPM SYSTEM" message will no longer display, and a pressure value will display in place of the dashes. A system fault can occur due to any of the following:

1. Jamming due to electronic devices or driving next to facilities emitting the same radio frequencies as the TPMS sensors.
2. Installing some form of aftermarket window tinting that affects radio wave signals.
3. Lots of snow or ice around the wheels or wheel housings.
4. Using tire chains on the vehicle.
5. Using wheels/tires not equipped with TPMS sensors.

**NOTE:**

1. The compact spare tire does not have a tire pressure monitoring sensor. Therefore, the TPMS will not monitor the pressure in the compact spare tire.
2. If you install the compact spare tire in place of a road tire that has a pressure below the low-pressure warning limit, upon the next ignition key cycle, the TPMS Telltale

light will remain on and a chime will sound. In addition, the graphic in the EVIC will still display a flashing pressure value.

3. After driving the vehicle for up to 10 minutes above 15 mph (25 km/h), the TPMS Telltale light will flash on and off for 75 seconds and then remain on solid. In addition, the EVIC will display a "CHECK TPM SYSTEM" message for three seconds and then display dashes (- -) in place of the pressure value.

4. For each subsequent ignition key cycle, a chime will sound, the TPMS Telltale light will flash on and off for 75 seconds and then remain on solid, and the EVIC will display a "CHECK TPM SYSTEM" message for three seconds and then display dashes (- -) in place of the pressure value.

5. Once you repair or replace the original road tire and reinstall it on the vehicle in place of the compact spare, the TPMS will update automatically. In addition, the

TPMS Telltale light will turn off and the graphic in the EVIC will display a new pressure value instead of dashes (- -), as long as no tire pressure is below the low-pressure warning limit in any of the four active road tires. The vehicle may need to be driven for up to 10 minutes above 15 mph (25 km/h) in order for the TPMS to receive this information.

### **General Information**

This device complies with Part 15 of the FCC rules and RSS 210 of Industry Canada. Operation is subject to the following conditions:

- This device may not cause harmful interference.
- This device must accept any interference received, including interference that may cause undesired operation.



The tire pressure sensors are covered under one of the following licenses:

United States . . . . . KR5S120123  
 Canada . . . . . 2671-S120123

### **FLEXIBLE FUEL— 2.7L ENGINES ONLY (EXCEPT CALIFORNIA EMISSION STATES)**

#### **E-85 GENERAL INFORMATION**

The information in this section is for Flexible Fuel vehicles only. This section only covers those subjects that are unique to these vehicles. Please refer to the other sections of this manual for information on features that are common between Flexible Fuel and gasoline only powered vehicles.

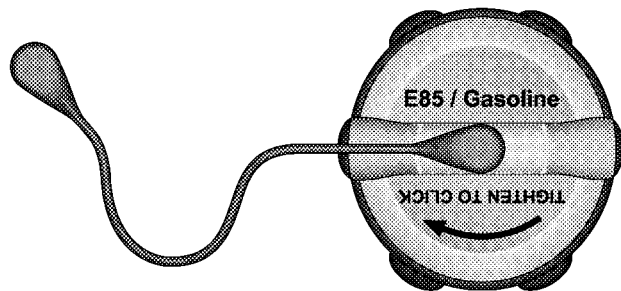

81ae46ab

**E-85 Fuel Cap**

#### **CAUTION!**

**Only vehicles with the special E-85 fuel filler cap can operate on E-85.**

Along with the special E-85 fuel filler cap, your vehicle may display a badge, which also indicates it can operate on E-85.



81ae46a9

E-85 Badge

### **ETHANOL FUEL (E-85)**

E-85 is a mixture of approximately 85% fuel ethanol and 15% unleaded gasoline.

#### **WARNING!**

Ethanol vapors are extremely flammable and could cause serious personal injury. Never have any smoking materials lit in or near the vehicle when removing the fuel filler tube cap (gas cap) or filling the tank. Do not use E-85 as a cleaning agent and never use it near an open flame.

### **FUEL REQUIREMENTS FOR FFV VEHICLES**

If your vehicle is E-85 compatible, it will operate on unleaded gasoline with an octane rating of 87, or E-85 fuel, or any mixture of these two fuels.

**For best results, a refueling pattern that avoids alternating between E-85 and unleaded gasoline is recommended.**

When you do switch fuel types it is recommended that:

- you do not add less than 5 gallons (19 L) when refueling
- you drive the vehicle immediately after refueling for at least 5 miles (8 km)

Observing these precautions will avoid possible hard starting and/or significant deterioration in drivability during warm up.

**NOTE:** Use seasonally adjusted E-85 fuel (ASTM D5798). With non-seasonally adjusted E-85 fuel you may experience hard starting and rough idle following start up even if the above recommendations are followed, especially when the ambient temperature is below 32°F (0°C).

### **ENGINE BLOCK HEATER (IF EQUIPPED)**

Block heater usage is beneficial for E-85 startability when the ambient temperature is less than 32°F (0°C).

### **SELECTION OF ENGINE OIL FOR FLEXIBLE FUEL VEHICLES (E-85) AND GASOLINE VEHICLES**

FFV vehicles operated on E85 require specially formulated engine oils. These special requirements are included in Mopar® engine oils, and in equivalent oils meeting Chrysler Specification MS-6395. The manufacturer only recommends engine oils that are API Certified and meet the requirements of Material Standard MS-6395. MS-6395 contains additional requirements, developed during extensive fleet testing, to provide additional protection to the manufacturer's engines. Use Mopar® or an equivalent oil meeting the specification MS-6395.

**NOTE:** Your engine oil filler cap also describes the correct engine oil to use.

## STARTING

The characteristics of E-85 fuel make it unsuitable for use when ambient temperatures fall below 0°F (-18°C). In the range of 0°F (-18°C) to 32°F (0°C), you may experience an increase in the time it takes for your engine to start, and a deterioration in driveability (sags and/or hesitations) until the engine is fully warmed up.

## CRUISING RANGE

Because E-85 fuel contains less energy per gallon than gasoline, you will experience an increase in fuel consumption. You can expect your fuel economy and driving range to decrease by about 30% compared to gasoline operation.

## REPLACEMENT PARTS

Many components in your Flexible Fuel Vehicle (FFV) are designed to be compatible with ethanol. Always be sure that your vehicle is serviced with correct ethanol compatible parts.

### CAUTION!

**Replacing fuel system components with non-ethanol compatible components can damage your vehicle.**

## MAINTENANCE

### CAUTION!

**Do not use ethanol mixture greater than 85% in your vehicle. It will cause difficulty in cold starting and may affect driveability.**

## FUEL REQUIREMENTS

### 2.4L and 2.7L Engines



800dfab6

2.4L and 2.7L Engines are designed to meet all emissions regulations and provide excellent fuel economy and performance when using high-quality unleaded “regular” gasoline having an octane rating of 87.

The use of premium gasoline is not recommended. Under normal conditions, the use of premium gasoline will not provide a benefit over high-quality unleaded regular gasolines, and in some circumstances may result in poorer performance.

### 3.5L Engine



800dfab6



800dfab7

The 3.5L Engine is designed to meet all emissions regulations and provide satisfactory fuel economy and performance when using high-quality unleaded gasoline having an octane range of 87 to 89. The manufacturer recommends the use of 89 octane for optimum performance. The use of premium gasoline is not recommended. Under normal conditions, the use of premium gasoline will not provide a benefit over high-quality regular and mid-grade gasolines, and in some circumstances may result in poorer performance.

Light spark knock at low engine speeds is not harmful to your engine. However, continued heavy spark knock at high speeds can cause damage and immediate service is required. Poor quality gasoline can cause problems such

as hard starting, stalling, and hesitations. If you experience these symptoms, try another brand of gasoline before considering service for the vehicle.

Over 40 auto manufacturers worldwide have issued and endorsed consistent gasoline specifications (the World Wide Fuel Charter, WWFC) which define fuel properties necessary to deliver enhanced emissions, performance, and durability for your vehicle. The manufacturer recommends the use of gasolines that meet the WWFC specifications, if they are available.

### **Reformulated Gasoline**

Many areas of the country require the use of cleaner burning gasoline referred to as reformulated gasoline. Reformulated gasolines contain oxygenates and are specifically blended to reduce vehicle emissions and improve air quality.

The manufacturer supports the use of reformulated gasolines. Properly blended reformulated gasolines will provide excellent performance and durability of engine and fuel system components.

### **Gasoline/Oxygenate Blends**

Some fuel suppliers blend unleaded gasoline with oxygenates such as 10% ethanol, MTBE, and ETBE. Oxygenates are required in some areas of the country during the Winter months to reduce carbon monoxide emissions. Fuels blended with these oxygenates may be used in your vehicle.

**CAUTION!**

**For vehicles equipped with a 2.4L or 3.5L engine, DO NOT use gasoline containing Methanol or E85 Ethanol. Use of these blends may result in starting and driveability problems and may damage critical fuel system components.**

**NOTE:** The **2.7L engine** is now rated for E85 Ethanol use (**EXCEPT CALIFORNIA EMISSION STATES**). Only vehicles with the E-85 fuel filler door label can operate on E-85. For more information, refer to “Flexible Fuel” in this section.

Problems that result from using methanol/gasoline or E85 ethanol blends are not the responsibility of the manufacturer. While MTBE is an oxygenate made from Methanol, it does not have the negative effects of methanol.

**MMT In Gasoline**

MMT is a manganese-containing metallic additive that is blended into some gasoline to increase octane. Gasoline blended with MMT provides no performance advantage beyond gasoline of the same octane number without MMT. Gasoline blended with MMT reduces spark plug life and reduces emission system performance in some vehicles. The manufacturer recommends that gasoline without MMT be used in your vehicle. The MMT content of gasoline may not be indicated on the gasoline pump, therefore, you should ask your gasoline retailer whether the gasoline contains MMT. It is even more important to look for gasoline without MMT in Canada, because MMT can be used at levels higher than those allowed in the United States. MMT is prohibited in Federal and California reformulated gasoline.

### Materials Added to Fuel

All gasoline sold in the United States is required to contain effective detergent additives. Use of additional detergents or other additives is not needed under normal conditions and they would result in additional cost. Therefore, you should not have to add anything to the fuel.

### Fuel System Cautions

<b>CAUTION!</b>
<b>Follow these guidelines to maintain your vehicle's performance:</b>

- The use of leaded gas is prohibited by Federal law. Using leaded gasoline can impair engine performance and damage the emissions control system.

- An out-of-tune engine or certain fuel or ignition malfunctions can cause the catalytic converter to overheat. If you notice a pungent burning odor or some light smoke, your engine may be out of tune or malfunctioning and may require immediate service. Contact your authorized dealer for service assistance.
- The use of fuel additives, which are now being sold as octane enhancers, is not recommended. Most of these products contain high concentrations of methanol. Fuel system damage or vehicle performance problems resulting from the use of such fuels or additives is not the responsibility of the manufacturer.

**NOTE:** Intentional tampering with the emissions control system can result in civil penalties being assessed against you.



## Carbon Monoxide Warnings

### WARNING!

**Carbon monoxide (CO) in exhaust gases is deadly. Follow the precautions below to prevent carbon monoxide poisoning:**

- Do not inhale exhaust gases. They contain carbon monoxide, a colorless and odorless gas, which can kill. Never run the engine in a closed area, such as a garage, and never sit in a parked vehicle with the engine running for an extended period. If the vehicle is stopped in an open area with the engine running for more than a short period, adjust the ventilation system to force fresh, outside air into the vehicle.

- Guard against carbon monoxide with proper maintenance. Have the exhaust system inspected every time the vehicle is raised. Have any abnormal conditions repaired promptly. Until repaired, drive with all side windows fully open.
- Keep the liftgate closed when driving your vehicle to prevent carbon monoxide and other poisonous exhaust gases from entering the vehicle.

## ADDING FUEL

### Fuel Filler Cap (Gas Cap)

The gas cap is located behind the fuel filler door on the left side of the vehicle. If the gas cap is lost or damaged, be sure the replacement cap has been designed for use with this vehicle.

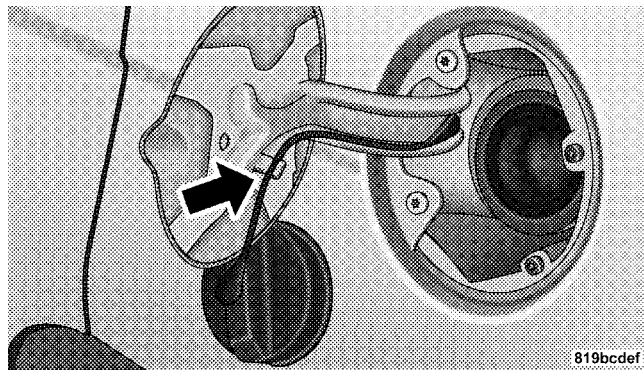

### Fuel Filler Cap (Gas Cap)

**NOTE:** When removing the fuel filler cap, lay the cap tether in the hook, located on the fuel filler door reinforcement.

### CAUTION!

- Damage to the fuel system or emissions control system could result from using an improper fuel tank filler tube cap (gas cap).
- A poorly fitting gas cap could let impurities into the fuel system.
- A poorly fitting gas cap may cause the Malfunction Indicator Light (MIL) to turn on.
- To avoid fuel spillage and overfilling, do not “top off” the fuel tank after filling. When the fuel nozzle “clicks” or shuts off, the fuel tank is full.

**WARNING!**

- **Never have any smoking materials lit in or near the vehicle when the gas cap is removed or the tank filled.**
- **Never add fuel to the vehicle when the engine is running.**
- **A fire may result if gasoline is pumped into a portable container that is inside of a vehicle. You could be burned. Always place gas containers on the ground while filling.**
- **Failure to follow this warning may result in serious injury or death.**

**NOTE:**

- Tighten the gas cap until you hear a “clicking” sound. This is an indication that the gas cap is tightened

properly. The MIL in the instrument cluster may turn on if the gas cap is not secured properly. Make sure that the gas cap is tightened each time the vehicle is refueled.

- When the fuel nozzle “clicks” or shuts off, the fuel tank is full.

**Loose Fuel Filler Cap Message**

If the vehicle diagnostic system determines that the fuel filler cap is loose, improperly installed, or damaged, the word “gASCAP” will display in the odometer. If this occurs, tighten the fuel filler cap until a “clicking” sound is heard and press the TRIP ODOMETER button to turn off the message. If the problem persists, the message will appear the next time the vehicle is started.

A loose, improperly installed, or damaged fuel filler cap may also turn on the MIL. Refer to “Onboard Diagnostic System — OBD II” in Section 7.

## VEHICLE LOADING

The load carrying capacity of your vehicle is shown on the “Vehicle Certification Label.” This information should be used for passenger and luggage loading as indicated.

Do not exceed the specified Gross Vehicle Weight Rating (GVWR) or the Gross Axle Weight Rating (GAWR).

### Vehicle Certification Label

Your vehicle has a Vehicle Certification Label affixed to the rear of the driver’s door.

The label contains the following information:

- Name of manufacturer
- Month and year of manufacture
- Gross Vehicle Weight Rating (GVWR)
- Gross Axle Weight Rating (GAWR) front

- Gross Axle Weight Rating (GAWR) rear
- Vehicle Identification Number (VIN)
- Type of Vehicle
- Month Day and Hour of Manufacture (MDH)

The bar code allows a computer scanner to read the VIN.

### Gross Vehicle Weight Rating (GVWR)

The GVWR is the total allowable weight of your vehicle. This includes driver, passengers, and cargo. The total load must be limited so that you do not exceed the GVWR.

### Gross Axle Weight Rating (GAWR)

The GAWR is the maximum capacity of the front and rear axles. Distribute the load over the front and rear axles evenly. Make sure that you do not exceed either front or rear GAWR.

**WARNING!**

**Because the front wheels steer the vehicle, it is important that you do not exceed the maximum front or rear GAWR. A dangerous driving condition can result if either rating is exceeded. You could lose control of the vehicle and have an accident.**

**Overloading**

The load carrying components (axle, springs, tires, wheels, etc.) of your vehicle will provide satisfactory service as long as you do not exceed the GVWR and the front and rear GAWR.

The best way to figure out the total weight of your vehicle is to weigh it when it is fully loaded and ready for operation. Weigh it on a commercial scale to ensure that it is not over the GVWR.

Figure out the weight on the front and rear of the vehicle separately. It is important that you distribute the load evenly over the front and rear axles.

Overloading can cause potential safety hazards and shorten useful service life. Heavier axles or suspension components do not necessarily increase the vehicle's GVWR.

**Loading**

To load your vehicle properly, first figure out its empty weight, axle-by-axle and side-by-side. Store heavier items down low and be sure you distribute their weight as evenly as possible. Stow all loose items securely before driving. If weighing the loaded vehicle shows that you have exceeded either GAWR, but the total load is within the specified GVWR, you must redistribute the weight. Improper weight distribution can have an adverse effect on the way your vehicle steers and handles and the way the brakes operate.

A loaded vehicle is shown in the illustration. Note that neither the GVWR nor the GAWR capacities have been exceeded.

<b>EXAMPLE ONLY</b>	<b>Front Axle</b>	<b>Rear Axle</b>
Empty Weight	2054 lbs (932 kg)	1805 lbs (819 kg)
Load (including driver, passengers, and cargo)	271 lbs (123 kg)	579 lbs (263 kg)
Total	2325 lbs (1055 kg)	2384 lbs (1081 kg)
GAWR	2546 lbs (1155 kg)	2708 lbs (1228 kg)

**NOTE:** Refer to the “Vehicle Certification Label” affixed to the rear of the driver’s door for your vehicle’s GVWR and GAWRs. This table is only an example.

## TRAILER TOWING

In this section, you will find safety tips and information on limits to the type of towing you can reasonably do with your vehicle. Before towing a trailer, carefully review this information to tow your load as efficiently and safely as possible.

To maintain warranty coverage, follow the requirements and recommendations in this manual concerning vehicles used for trailer towing.

### Common Towing Definitions

The following trailer towing related definitions will assist you in understanding the following information:

#### Gross Vehicle Weight Rating (GVWR)

The Gross Vehicle Weight Rating (GVWR) is the total allowable weight of your vehicle. This includes driver, passengers, cargo, and tongue weight. The total load must be limited so that you do not exceed the GVWR.

### **Gross Trailer Weight (GTW)**

The Gross Trailer Weight (GTW) is the weight of the trailer plus the weight of all cargo, consumables, and equipment (permanent or temporary) loaded in or on the trailer in its "loaded and ready for operation" condition. The recommended way to measure GTW is to put your fully loaded trailer on a vehicle scale. The entire weight of the trailer must be supported by the scale.

### **Gross Combination Weight Rating (GCWR)**

The Gross Combination Weight Rating (GCWR) is the total permissible weight of your vehicle and trailer when weighed in combination. (Note that GCWR ratings include a 150 lbs (68 kg) allowance for the presence of a driver.)

### **Gross Axle Weight Rating (GAWR)**

The Gross Axle Weight Rating (GAWR) is the maximum capacity of the front and rear axles. Distribute the load over the front and rear axles evenly. Make sure that you do not exceed either front or rear GAWR.

#### **WARNING!**

**It is important that you do not exceed the maximum front or rear GAWR. A dangerous driving condition can result if either rating is exceeded. You could lose control of the vehicle and have an accident.**

5

### **Tongue Weight (TW)**

Tongue weight (TW) is the downward force exerted on the hitch ball by the trailer. In most cases, it should not be less than 10% or more than 15% of the trailer load. You must consider this as part of the load on your vehicle.

**Frontal Area**

Frontal area is the maximum height and maximum width of the front of a trailer.

**Trailer Sway Control — Electronic**

Refer to “TSC (Trailer Sway Control)” under “Electronic Brake Control System” in this section for information on this system.

**Trailer Sway Control — Mechanical**

The trailer sway control is a telescoping link that can be installed between the hitch receiver and the trailer tongue that typically provides adjustable friction associated with the telescoping motion to dampen any unwanted trailer swaying motions while traveling.

**Weight-Carrying Hitch**

A weight-carrying hitch supports the trailer tongue weight, just as if it were luggage located at a hitch ball or some other connecting point of the vehicle. These kinds

of hitches are the most popular on the market today and they are commonly used to tow small- and medium-sized trailers.

**Weight-Distributing Hitch**

A weight-distributing system works by applying leverage through spring (load) bars. They are typically used for heavier loads to distribute trailer tongue weight to the tow vehicle’s front axle and the trailer axle(s). When used in accordance with the manufacturers directions, it provides for a more level ride, offering more consistent steering and brake control thereby enhancing towing safety. The addition of a friction / hydraulic sway control also dampens sway caused by traffic and crosswinds and contributes positively to tow vehicle and trailer stability. Trailer sway control and a weight distributing (load equalizing) hitch are recommended for heavier Tongue Weights (TW) and may be required depending on vehicle and trailer configuration / loading to comply with Gross Axle Weight Rating (GAWR) requirements.



**WARNING!**

- An improperly adjusted weight distributing hitch system may reduce handling, stability, braking performance, and could result in an accident.
- Weight distributing systems may not be compatible with surge brake couplers. Consult with your hitch and trailer manufacturer or a reputable recreational vehicle dealer for additional information.

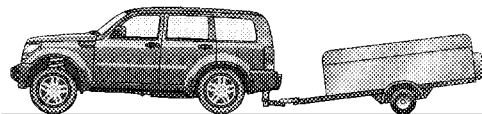
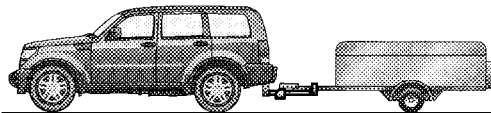
**EXAMPLE ONLY****FIG. 1 WITHOUT WEIGHT DISTRIBUTION (INCORRECT)****FIG. 2. WITH WEIGHT DISTRIBUTION (CORRECT)**

81a3a787

**Weight Distributing Hitch System**

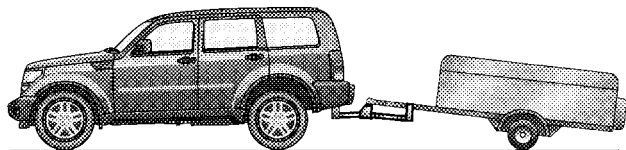
**EXAMPLE ONLY****FIG. 3 IMPROPER ADJUSTMENT (INCORRECT)**

81a3a807

### Improper Adjustment of Weight Distributing System Trailer Hitch Classification

Your vehicle may be factory equipped for safe towing of trailers weighing over 2,000 lbs (907 kg) with the optional Trailer Tow Prep Package. See your authorized dealer for package content.

The following chart provides the industry standard for the maximum trailer weight a given trailer hitch class can tow and should be used to assist you in selecting the correct trailer hitch for your intended towing condition.

<b>Trailer Hitch Classification Definitions</b>	
<b>Class</b>	<b>Max. Trailer Hitch Industry Standards</b>
Class I - Light Duty	2,000 lbs (907 kg)
Class II - Medium Duty	3,500 lbs (1587 kg)
Class III - Heavy Duty	5,000 lbs (2268 kg)
Class IV - Extra Heavy Duty	10,000 lbs (4540 kg)
Refer to the "Trailer Towing Weights (Maximum Trailer Weight Ratings)" chart for the Maximum Gross Trailer Weight (GTW) towable for your given drivetrain.	

All trailer hitches should be professionally installed on your vehicle.

### Trailer Towing Weights (Maximum Trailer Weight Ratings)

The following chart provides the maximum trailer weight ratings towable for your given drivetrain.

Engine/Transaxle	GCWR (Gross Combined Wt. Rating)	Frontal Area	Max. GTW (Gross Trailer Wt.)	Max. Tongue Wt.
<b>2.4L Automatic</b>	6,000 lbs (2,722 kg)	22 sq ft (2.0 sq m)	1,000 lbs (454 kg) which includes up to 5 persons & Luggage	100 lbs (45 kg)
<b>2.7L/3.5L (with out Trailer Tow Prep Package (AHT))</b>	7,300 lbs (3,311 kg)	32 sq ft (3.0 sq m)	2,000 lbs (907 kg) which includes 1 to 2 persons & Luggage	200 lbs (91 kg)
	7,300 lbs (3,311 kg)	32 sq ft (3.0 sq m)	1,500 lbs (680 kg) which includes 3 to 4 persons & Luggage	150 lbs (68 kg)
	7,300 lbs (3,311 kg)	32 sq ft (3.0 sq m)	1,000 lbs (454 kg) which includes 5 to 7 persons & Luggage	100 lbs (45 kg) *Except for AWD models.
<b>2.7L (with Trailer Tow Prep Package (AHT))</b>	8,300 lbs (3,765 kg)	40 sq ft (3.7 sq m)	3,000 lbs (1,361 kg) which includes up to 5 persons & Luggage	300 lbs (136 kg)
	8,300 lbs (3,765 kg)	40 sq ft (3.7 sq m)	1,000 lbs (454 kg) which includes 6 to 7 persons & Luggage	100 lbs (91 kg)

Engine/Transaxle	GCWR (Gross Combined Wt. Rating)	Frontal Area	Max. GTW (Gross Trailer Wt.)	Max. Tongue Wt.
<b>3.5L (with Trailer Tow Prep Package (AHT))</b>	8,300 lbs (3,765 kg)	40 sq ft (3.7 sq m)	3,500 lbs (1,588 kg) which includes 1 to 2 persons & Luggage	350 lbs (159 kg)
	8,300 lbs (3,765 kg)	40 sq ft (3.7 sq m)	3,000 lbs (1,361 kg) which includes 3 to 4 persons & Luggage	300 lbs (136 kg)
	8,300 lbs (3,765 kg)	40 sq ft (3.7 sq m)	2,500 lbs (1,134 kg) 5 to 6 persons & Luggage	250 lbs (113 kg) *Except for AWD models.
	8,300 lbs (3,765 kg)	40 sq ft (3.7 sq m)	2,500 lbs (1,134 kg) which includes 7 persons & Luggage	100 lbs (113 kg) *Except for AWD models.
<p><b>NOTE:</b> The trailer tongue weight must be considered as part of the combined weight of occupants and cargo, and should never exceed the weight referenced on the Tire and Loading Information placard. Refer to the Tire-Safety Information Section in this manual.</p> <p><b>NOTE:</b> * For All Wheel Drive (AWD) models carrying 5 to 7 persons and luggage will exceed the rear Gross Axle Weight Rating (GAWR) and therefore should not be attempted.</p>				

### Trailer and Tongue Weight

Always load a trailer with 60% to 65% of the weight in the front of the trailer. This places 10% to 15% of the Gross Trailer Weight (GTW) on the tow hitch of your vehicle. Loads balanced over the wheels or heavier in the rear can cause the trailer to sway **severely** side to side which will cause loss of control of the vehicle and trailer. Failure to load trailers heavier in front is the cause of many trailer accidents.

Never exceed the maximum tongue weight stamped on your bumper or trailer hitch.

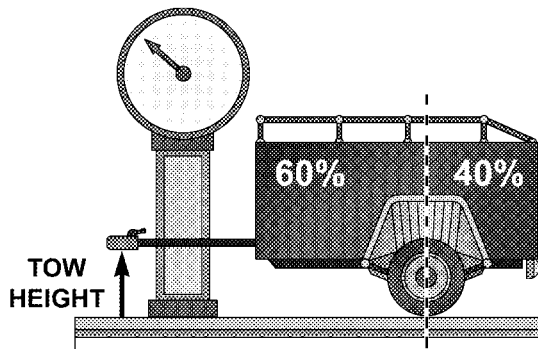

81546c40

5

Consider the following items when computing the weight on the rear axle of the vehicle:

- The tongue weight of the trailer.
- The weight of any other type of cargo or equipment put in or on your vehicle.
- The weight of the driver and all passengers.

**NOTE:** Remember that everything put into or on the trailer adds to the load on your vehicle. Also, additional factory-installed options or authorized dealer-installed options must be considered as part of the total load on your vehicle. Refer to the “Tire and Loading Information” placard for the maximum combined weight of occupants and cargo for your vehicle.

### **Towing Requirements**

To promote proper break-in of your new vehicle drivetrain components the following guidelines are recommended:

### **CAUTION!**

- **Avoid towing a trailer for the first 500 mi (805 km) of vehicle operation. Doing so may damage your vehicle.**
- **During the first 500 mi (805 km) of trailer towing, limit your speed to 50 mph (80 km/h).**

Perform the maintenance listed in Section 8. When towing a trailer, never exceed the GAWR, or GCWR, ratings.

**WARNING!**

**Improper towing can lead to an injury accident. Follow these guidelines to make your trailer towing as safe as possible:**

**Make certain that the load is secured in the trailer and that it will not shift during travel. When trailering cargo that is not fully secured, dynamic load shifts can occur that may be difficult for the driver to control. You could lose control of your vehicle and have an accident.**

- When hauling cargo or towing a trailer, do not overload your vehicle or trailer. Overloading can cause a loss of control, poor performance, or damage to brakes, axle, engine, transaxle, steering, suspension, chassis structure, or tires.

- Safety chains must always be used between your vehicle and trailer. Always connect the chains to the frame or hook retainers of the vehicle hitch. Cross the chains under the trailer tongue and allow enough slack for turning corners.
- Vehicles with trailers should not be parked on a grade. When parking, apply the parking brake on the tow vehicle. Put the tow vehicle automatic transaxle in PARK. Always, block or "chock" the trailer wheels.
- GCWR must not be exceeded.
- **Total weight must be distributed between the tow vehicle and the trailer such that the following four ratings are not exceeded:**
  1. GVWR
  2. GTW
  3. GAWR

4. Tongue weight rating for the trailer hitch utilized. (This requirement may limit the ability to always achieve the 10% to 15% range of tongue weight as a percentage of total trailer weight.)

### **Towing Requirements — Tires**

- Do not attempt to tow a trailer while using a compact spare tire.
- Proper tire inflation pressures are essential to the safe and satisfactory operation of your vehicle. Refer to “Tires–General Information” in this section for information on tire pressures and for proper tire inflation procedures.
- Also, check the trailer tires for proper tire inflation pressures before trailer usage.

- Check for signs of tire wear or visible tire damage before towing a trailer. Refer to “Tires–General Information” in this section for information on tread wear indicators and for the proper inspection procedure.
- When replacing tires, refer to “Tires–General Information” in this section for information on replacement tires and for the proper tire replacement procedures. Replacing tires with a higher load carrying capacity will not increase the vehicle’s GVWR and GAWR limits.

### **Towing Requirements — Trailer Brakes**

- Do **not** interconnect the hydraulic brake system or vacuum system of your vehicle with that of the trailer. This could cause inadequate braking and possible personal injury.



- An electronically actuated trailer brake controller is required when towing a trailer with electronically actuated brakes. When towing a trailer equipped with a hydraulic surge actuated brake system, an electronic brake controller is not required.
- Trailer brakes are recommended for trailers over 1,000 lbs (454 kg) and required for trailers in excess of 2,000 lbs (907 kg).

### CAUTION!

If the trailer weighs more than 1,000 lbs (454 kg) loaded, it should have its own brakes, and they should be of adequate capacity. Failure to do this could lead to accelerated brake lining wear, higher brake pedal effort, and longer stopping distances.

### WARNING!

**Do not connect trailer brakes to your vehicle's hydraulic brake lines. It can overload your brake system and cause it to fail. You might not have brakes when you need them and could have an accident.**

**Towing any trailer will increase your stopping distance. When towing, you should allow for additional space between your vehicle and the vehicle in front of you. Failure to do so could result in an accident.**

**Towing Requirements — Trailer Lights and Wiring**  
Whenever you pull a trailer, regardless of the trailer size, stoplights and turn signals on the trailer are required for motoring safety.

The Trailer Tow Package may include a 4- and 7-pin wiring harness. Use a factory approved trailer harness and connector.

**NOTE:** Do not cut or splice wiring into the vehicles wiring harness.

The electrical connections are all complete to the vehicle but you must mate the harness to a trailer connector. Refer to the following illustrations.

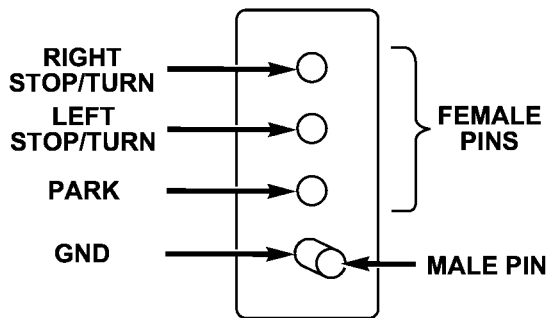

4-Pin Connector

813262be

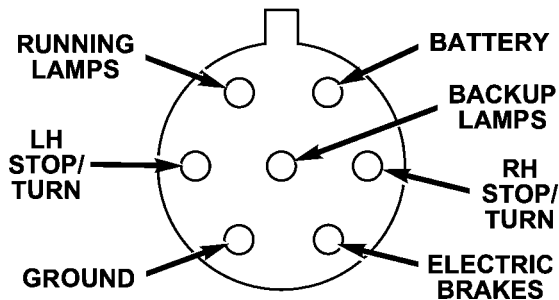

812634c6

7-Pin Connector

### Towing Tips

Before setting out on a trip, practice turning, stopping, and backing up the trailer in an area located away from heavy traffic.

### Towing Tips — Automatic Transaxle

The DRIVE range can be selected when towing. However, if frequent shifting occurs while in this range, select the “3” range for 4-speed automatic or the “5” range for 6-speed automatic.

**NOTE:** Using the “3” or “5” range while operating the vehicle under heavy operating conditions will improve performance and extend transaxle life by reducing excessive shifting and heat build up. This action will also provide better engine braking.

If you REGULARLY tow a trailer for more than 45 minutes of continuous operation, then change the automatic transaxle fluid and filter according to the interval specified for “police, taxi, fleet, or frequent trailer towing” in the Maintenance Schedule.

**NOTE:** Check the 4-speed automatic transaxle fluid level before towing. The 6-speed transaxle is sealed and the fluid level cannot be checked. See your authorized dealer for assistance.

### **Towing Tips — Electronic Speed Control (If Equipped)**

- Don't use in hilly terrain or with heavy loads.
- When using the speed control, if you experience speed drops greater than 10 mph (16 km/h), disengage until you can get back to cruising speed.
- Use speed control in flat terrain and with light loads to maximize fuel efficiency.

### **Towing Tips — Autostick® (If Equipped)**

- By using the Autostick® modes and selecting a specific gear range, frequent shifting can be avoided. The highest gear range should be selected that allows for adequate performance. For example, choose “4” if the desired speed can be maintained. Choose “3” or “2” if needed to maintain the desired speed.
- Extended driving at high RPM should be avoided to prevent excess heat generation. A reduction in vehicle speed may be required to avoid extended driving at high RPM. Return to a higher gear range or vehicle speed when road conditions and RPM level allows.

### **Towing Tips — Cooling System**

To reduce potential for engine and transaxle overheating, take the following actions:

– ***City Driving***

When stopped for short periods, put transaxle in NEUTRAL and increase engine idle speed.

– ***Highway Driving***

Reduce speed.

– ***Air Conditioning***

Turn off temporarily.

– Refer to “Cooling System” under “Maintenance Procedures” in Section 7.

### **RECREATIONAL TOWING (BEHIND MOTORHOME, ETC.)**

#### **TOWING THIS VEHICLE BEHIND ANOTHER VEHICLE (Flat Towing With All Four Wheels On The Ground)**

Recreational towing for this vehicle is not recommended.

**NOTE:** If the vehicle requires towing, make sure all four wheels are off the ground.



# WHAT TO DO IN EMERGENCIES

## CONTENTS

---

■ Hazard Warning Flasher . . . . .	390	□ Jacking Instructions . . . . .	398
■ If Your Engine Overheats . . . . .	390	■ Jump-Starting Procedures . . . . .	404
□ Engine Oil Overheating — 2.4L Gas And 2.0L Diesel Engines Only (If Equipped) . . . . .	392	■ Freeing A Stuck Vehicle . . . . .	408
■ Jacking And Tire Changing . . . . .	392	■ Towing A Disabled Vehicle . . . . .	409
□ Jack Location . . . . .	393	□ Without The Ignition Key . . . . .	409
□ Spare Tire Location . . . . .	393	□ Towing This Vehicle Behind Another Vehicle (Flat Towing With The Key In The Ignition And All Four Wheels On The Ground) . . . . .	410
□ Preparations For Jacking . . . . .	393	□ Towing This Vehicle Behind Another Vehicle With A Tow Dolly . . . . .	411
□ Spare Tire Removal . . . . .	394		
□ Spare Tire Stowage . . . . .	396		

## HAZARD WARNING FLASHER

The HAZARD switch is located in the instrument panel switch bank above the climate controls.

 Push and release the switch to turn on the hazard warning flashers. When the hazard warning is activated, all directional turn signals will flash on and off to warn oncoming traffic of an emergency. Push and release the switch a second time to turn off the flashers.

This is an emergency warning system and it should not be used when the vehicle is in motion. Use it when your vehicle is disabled and it is creating a safety hazard for other motorists.

When you must leave the vehicle to seek assistance, the hazard warning flashers will continue to operate even though the ignition switch is in the LOCK position.

**NOTE:** With extended use, the hazard warning flashers may wear down your battery.

## IF YOUR ENGINE OVERHEATS

In any of the following situations, you can reduce the potential for overheating by taking the appropriate action.

- On the highways — Slow down.
- In city traffic — While stopped, put the transaxle in NEUTRAL, but do not increase engine idle speed.

**NOTE:** There are steps that you can take to slow down an impending overheat condition. If your Air Conditioning A/C system is on, turn it off. The A/C system adds heat to the engine cooling system and turning off the A/C system removes this heat. You can also turn the Temperature control to maximum heat, the Mode control to floor, and the Blower control to High. This allows the



heater core to act as a supplement to the radiator and aids in removing heat from the engine cooling system.

### **CAUTION!**

**Driving with a hot cooling system could damage your vehicle. If the temperature gauge reads “H,” safely pull over and stop the vehicle. Idle the vehicle with the A/C turned off until the pointer drops back into the normal range. If the pointer remains on the “H,” and you hear continuous chimes, turn the engine OFF immediately, and call for service.**

### **WARNING!**

**A hot engine cooling system is dangerous. You or others could be badly burned by steam or boiling coolant. You may want to call a service center if your vehicle overheats. If you decide to look under the hood yourself, refer to Section 7 and follow the warnings under the Cooling System Pressure Cap paragraph.**

### Engine Oil Overheating — 2.4L Gas and 2.0L Diesel Engines Only (If Equipped)

On hot days the engine oil temperature may become too hot during sustained high-speed driving or if towing a trailer up long grades. If this happens, a HOTOIL message will flash in the odometer and the vehicle speed will be reduced to 48 mph (77 km/h) maximum until the engine oil temperature is reduced.

**NOTE:** Although the maximum vehicle speed is reduced to 48 mph (77 km/h), you may of course reduce vehicle speed further as needed.

### JACKING AND TIRE CHANGING

#### WARNING!

- Do not attempt to change a tire on the side of the vehicle close to moving traffic. Pull far enough off the road to avoid the danger of being hit when operating the jack or changing the wheel.
- Getting under a jacked-up vehicle is dangerous. The vehicle could slip off the jack and fall on you. You could be crushed. Never get any part of your body under a vehicle that is on a jack. Never start or run the engine while the vehicle is on a jack. If you need to get under a raised vehicle, take it to a service center where it can be raised on a lift.
- The jack is designed to use as a tool for changing tires only. The jack should not be used to lift the vehicle for service purposes. The vehicle should be jacked on a firm level surface only. Avoid ice or slippery areas.
- A loose tire or jack thrown forward in a collision or hard stop could endanger the occupants of the vehicle. Always stow the jack parts and the spare tire in the places provided.

### Jack Location

The jack and jack-handle are stowed underneath a cover in the rear storage bin in the cargo area.

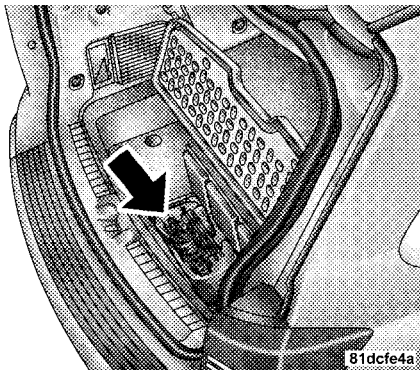

**Jack Storage Location**

### Spare Tire Location

The spare tire is stowed underneath the rear of the vehicle and is held in place by means of a cable winch mechanism.

### Preparations For Jacking

1. Park the vehicle on a firm level surface as far from the edge of the roadway as possible. Avoid icy or slippery areas.
2. **Set the parking brake** and place the shift lever in **PARK**.
3. Turn **OFF** the ignition.
4. Turn **ON** the hazard warning flashers.
5. Passengers should not remain in the vehicle when the vehicle is being jacked.



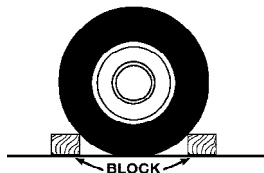

6. Block both the front and rear of the wheel diagonally opposite the jacking position. For example, if changing the right front tire, block the left rear wheel.

### Spare Tire Removal

**NOTE:** On Seven-Passenger Models, fold the third-row passenger seats flat. This will provide more space when accessing the jacking tools and when operating the winch mechanism.

1. Remove the jack-handle components 1, 2, and 3 from storage and assemble them.

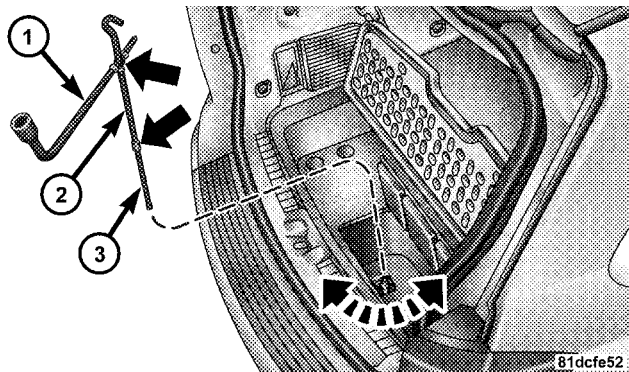

### Lowering/Raising Spare Tire

**NOTE:** Assemble components 2 and 3 by seating the small ball at the end of component 2 in the small hole at the end of component 3. This will lock these components together. Assemble components 1 and 2 so that the wheel nut socket at the end of component 1 faces upward when

seated on component 2. This will make it easier to rotate the assembly when operating the winch mechanism.

2. Fit the assembled jack-handle over the winch drive nut located in the jack storage area. Rotate the jack-handle assembly counterclockwise until the spare tire is on the ground with enough cable slack to allow you to pull the spare tire out from underneath the vehicle.

### CAUTION!

The winch mechanism is designed for use with the jack-handle only. Use of an air wrench or other power tools is not recommended and it can damage the winch.

3. Pull the spare tire out from underneath the vehicle and raise it upright so the tire's tread is on the ground.

4. Tilt the retainer at the end of the winch cable and remove it from the center of the wheel.

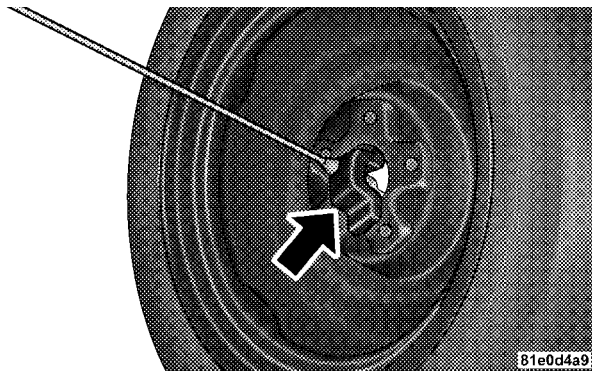

Spare Tire Retainer

## Spare Tire Stowage

**NOTE:** On Seven-Passenger Models, fold the third-row passenger seats flat. This will provide more space when accessing the jacking tools and when operating the winch mechanism.

1. Remove the jack-handle components 1, 2, and 3 from storage and assemble them.

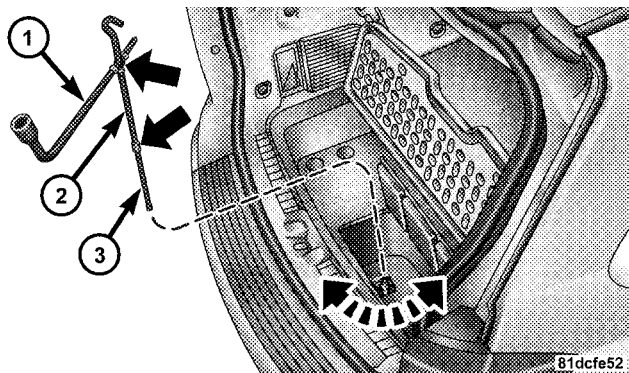

Lowering/Raising Spare Tire

**NOTE:** Assemble components 2 and 3 by seating the small ball at the end of component 2 in the small hole at the end of component 3. This will lock these components together. Assemble components 1 and 2 so that the wheel nut socket at the end of component 1 faces upward when seated on component 2. This will make it easier to rotate the assembly when operating the winch mechanism.

2. Fit the assembled jack-handle over the winch drive nut located in the jack storage area. Rotate the jack-handle assembly counterclockwise until there is enough cable slack to allow you to pull the cable and retainer out from underneath the vehicle.

### CAUTION!

**The winch mechanism is designed for use with the jack-handle only. Use of an air wrench or other power tools is not recommended and it can damage the winch.**

3. Place the spare tire near to the winch cable. Hold the spare upright so that the tire's tread is on the ground and the valve stem is at the top of the wheel and facing away from the rear of the vehicle.

4. Tilt the retainer at the end of the winch cable and drop it through the center of the wheel. Then place the spare tire with the cable and retainer underneath the vehicle.

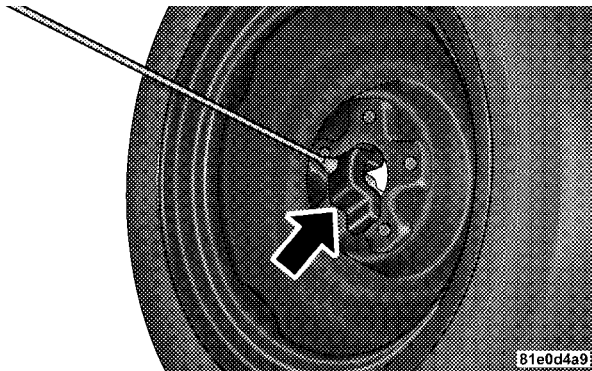

Spare Tire Retainer

5. Fit the assembled jack-handle over the winch drive nut. Rotate the jack-handle assembly clockwise to raise the spare tire into the storage area. Continue to rotate the jack-handle assembly until you hear the winch mechanism click three times. It cannot be over tightened. Push against the tire several times to be sure it is held securely in place.

### Jacking Instructions



Jack Warning Label



**WARNING!**

Carefully follow these tire changing warnings to help prevent personal injury or damage to your vehicle:

- Always park on a firm, level surface as far from the edge of the roadway as possible before raising the vehicle.
- Block the wheel diagonally opposite the wheel to be raised.
- Set the parking brake firmly and set an automatic transaxle in PARK; a manual transaxle in REVERSE.
- Never start or run the engine with the vehicle on a jack.
- Do not let anyone sit in the vehicle when it is on a jack.
- Do not get under the vehicle when it is on a jack.
- Only use the jack in the positions indicated and for lifting this vehicle during a tire change.
- If working on or near a roadway, be extremely careful of motor traffic.
- To assure that spare tires, flat or inflated are securely stowed, spares must be stowed with the valve stem facing the ground.
- Turn on the Hazard warning flasher.

1. Remove the spare tire, jack, and jack-handle from stowage.

2. Loosen, but do not remove, the wheel nuts on the wheel with the flat tire. Turn the wheel nuts counter-clockwise one turn while the wheel is still on the ground.

3. Place the jack underneath the lift area that is closest to the flat tire. Turn the jack screw clockwise to firmly engage the jack saddle with the lift area of the sill flange.

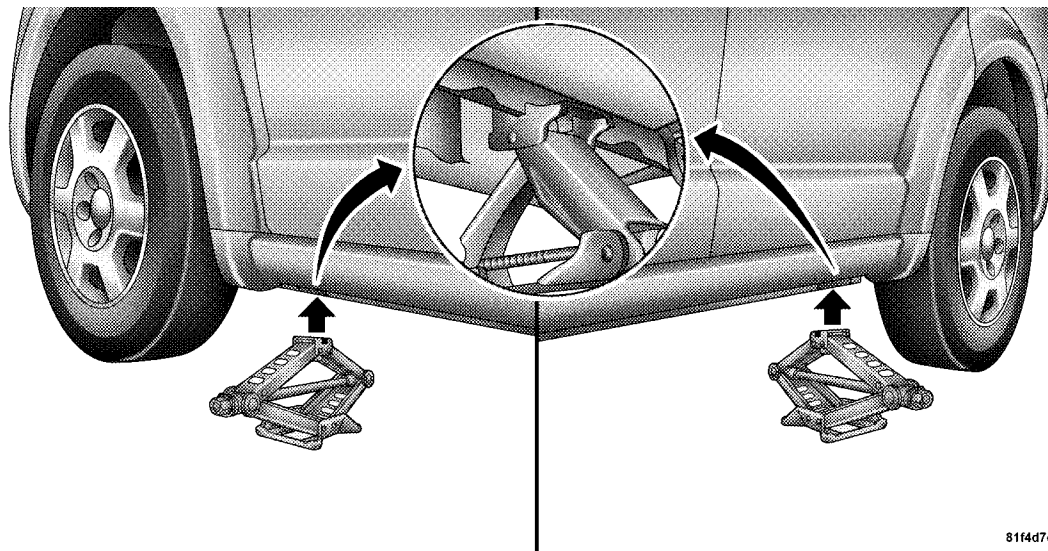

**Jack Engagement Locations**

81f4d7eb

4. Raise the vehicle by turning the jack screw clockwise with the jack handle. Raise the vehicle until the tire just clears the road surface and enough clearance is obtained to install the spare tire. Minimum tire lift provides maximum stability.

**WARNING!**

**Raising the vehicle higher than necessary can make the vehicle less stable. It could slip off the jack and hurt someone near it. Raise the vehicle only enough to remove the tire.**

5. Remove the wheel nuts. For vehicles so equipped, remove the wheel cover from the wheel by hand. Do not pry the wheel cover off. Then pull the wheel off the hub.

**WARNING!**

**To avoid possible personal injury, handle the wheel covers with care to avoid contact with any sharp edges.**

**NOTE:** For vehicles so equipped, the wheel cover is held on the wheel by the wheel nuts. When reinstalling the original wheel, properly align the wheel cover to the valve stem, place the wheel cover onto the wheel, and then install the wheel nuts.

6. Install the spare tire.

**NOTE:**

- For vehicles so equipped, do not attempt to install a center cap or wheel cover on the compact spare.

- Refer to “Compact Spare Tire” and to “Limited-Use Spare” under “Tires — General Information” in Section 5 for additional warnings, cautions, and information about the spare tire, its use, and operation.
7. Install the wheel nuts with the cone shaped end of the nut toward the wheel. Lightly tighten the wheel nuts.

**WARNING!**

**To avoid the risk of forcing the vehicle off the jack, do not tighten the wheel nuts fully until the vehicle has been lowered. Failure to follow this warning may result in personal injury or death.**

8. Lower the vehicle by turning the jack screw counter-clockwise with the jack handle.

9. Finish tightening the wheel nuts. Push down on the wrench while tightening for increased leverage. Alternate wheel nuts until each nut has been tightened twice. Correct wheel nut tightness is 95 ft lbs (130 N·m). If in doubt about the correct tightness, have them checked with a torque wrench by your authorized dealer or at a service station.

10. Lower the jack to its fully closed position.

**WARNING!**

**A loose tire or jack, thrown forward in a collision or hard stop could endanger the occupants of the vehicle. Always stow the jack parts and the spare tire in the places provided. Have the deflated (flat) tire repaired or replaced immediately.**

11. Place the deflated (flat) tire in the cargo area. **Do not stow the deflated tire in the spare tire stowage location.** Have the deflated (flat) tire repaired or replaced as soon as possible.
12. To stow the winch cable and retainer, fit the assembled jack-handle over the winch drive nut. Rotate the jack-handle assembly clockwise until you hear the winch mechanism click three times. It cannot be over tightened.
13. Stow the jack-handle and jack.
14. Check the tire pressure as soon as possible. Adjust the tire pressure as required.

### Wheel Nuts

Tighten all wheel nuts occasionally to eliminate the possibility of wheel studs being sheared or the bolt holes in the wheels becoming elongated. This is especially important during the first few hundred miles (kilometers) of operation and after changing a tire. This allows the wheel nuts to seat properly. All wheel nuts should first be firmly seated against the wheel. The wheel nuts should then be tightened to recommended torque. Tighten the wheel nuts to the final torque in increments. Progress around the bolt circle, tightening the nut opposite of the one you previously tightened until the final torque is achieved. Recommended torque is 95 ft lbs (130 N·m).

**JUMP-STARTING PROCEDURES****WARNING!**

- Take care to avoid the radiator cooling fan whenever the hood is raised. It can start anytime the ignition switch is ON. You can be hurt by the fan.
- Do not attempt to push or tow your vehicle to get it started. Vehicles equipped with an automatic transaxle cannot be started this way. Unburned fuel could enter the catalytic converter and once the engine has started, ignite and damage the converter and vehicle. If the vehicle has a discharged battery, booster cables may be used to obtain a start from another vehicle. This type of start can be dangerous if done improperly, so follow this procedure carefully.
- Do not use a booster battery or any other booster source with an output that exceeds 12 Volts.

**WARNING!**

- Battery fluid is a corrosive acid solution; do not allow battery fluid to contact eyes, skin, or clothing. Don't lean over battery when attaching clamps or allow the clamps to touch each other. If acid splashes in eyes or on skin, flush contaminated area immediately with large quantities of water.
- A battery generates hydrogen gas, which is flammable and explosive. Keep flame or spark away from the vent holes.

The battery is stored in a compartment that is located behind the left front fender and is accessible through the wheel well. Remote jump-start terminals are located in the engine compartment.

1. Wear eye protection and remove any metal jewelry such as watchbands or bracelets that might make an inadvertent electrical contact.
2. When boosting from a battery in another vehicle, park that vehicle within booster cable reach, but without allowing the vehicles to touch. Set parking brake, place automatic transaxle in PARK, and turn ignition to LOCK for both vehicles.

### **WARNING!**

**Do not permit vehicles to touch each other as this could establish a ground connection and personal injury could result.**

3. Turn off the heater, radio, and all unnecessary electrical loads.
4. Remove the protective cover over the remote jump-start positive battery post (+) in the engine compartment. Connect one end of the jumper cable to the positive battery post. Connect the other end of the same cable to the positive terminal of the booster battery. Refer to the following illustration for jump-starting connections.

5. Connect the other cable, first to the negative terminal of the booster battery and **then to the engine ground (-) of the vehicle with the discharged battery.** Make sure you have a good contact on the engine ground. Refer to the following illustration for jump-starting connections.

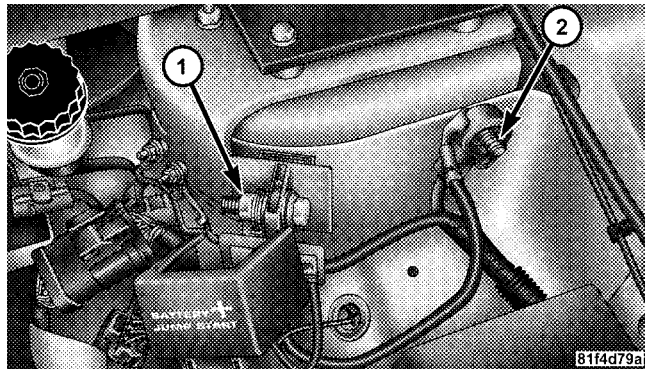

- 1 — Positive Terminal  
2 — Negative Terminal

6. If the vehicle is equipped with Sentry Key Immobilizer, turn the ignition switch to the ON position for three seconds before moving the ignition switch to the START position.

7. Start the engine in the vehicle that has the booster battery, let the engine idle a few minutes, and then start the engine in the vehicle with the discharged battery.

8. When removing the jumper cables, reverse the sequence exactly. Be careful of the moving belts and fan.

9. Reinstall the protective cover over the remote jump-start positive battery post.



**WARNING!**

During cold weather when temperatures are below freezing point, electrolyte in a discharged battery may freeze. Do not attempt jump-starting because the battery could rupture or explode. The battery temperature must be brought up above freezing point before attempting jump-start.

**NOTE:** Refer to “Maintenance Procedures” in Section 7 for information on accessing the battery for service or replacement.

**WARNING!**

Any procedure other than above could result in:

1. Personal injury caused by electrolyte squirting out the battery vent;
2. Personal injury or property damage due to battery explosion;
3. Damage to charging system of booster vehicle or of immobilized vehicle.

## FREEING A STUCK VEHICLE

If your vehicle becomes stuck in mud, sand, or snow, it can often be moved by a rocking motion. Turn your steering wheel right and left to clear the area around the front wheels. Then shift back and forth between REVERSE and 1st gear. Usually the least accelerator pedal pressure to maintain the rocking motion without spinning the wheels is most effective.

### NOTE:



If your vehicle is equipped with Traction Control, turn the system OFF before attempting to “rock” the vehicle. Refer to “Partial Off Mode” under “Electronic Stability Program (ESP)” in Section 5.

## WARNING!

**Fast spinning tires can be dangerous. Forces generated by excessive wheel speeds may cause axle and tire damage or failure. A tire could explode and injure someone. Do not spin your vehicle’s wheels faster than 30 mph (48 km/h) or for longer than 30 seconds continuously without stopping when you are stuck, and don’t let anyone near a spinning wheel, no matter what the speed.**

**CAUTION!**

Racing the engine or spinning the wheels too fast may lead to transaxle overheating and failure. It can also damage the tires. Do not spin the wheels above 30 mph (48 km/h). Do not spin the wheels continuously for more than 30 seconds.

**TOWING A DISABLED VEHICLE****Without The Ignition Key****Front Wheel Drive (FWD)**

Special care must be taken when the vehicle is towed with the ignition in the LOCK position. Flat bed towing is the preferred towing method. However, if a flat bed towing vehicle is not available, a wheel lift towing vehicle may be used. Furthermore, rear towing is not recommended with the front wheels on the ground, as transaxle damage can result. If rear towing is the only alternative, a front end dolly must be used. Proper towing equipment is necessary to prevent damage to the vehicle.

**All Wheel Drive (AWD)**

Your vehicle must be transported on a flat bed truck.

### **Towing This Vehicle Behind Another Vehicle (Flat Towing With The Key In The Ignition And All Four Wheels On The Ground)**

#### **CAUTION!**

- **If the vehicle being towed requires steering, the ignition switch must be in the ON position, not in the LOCK or ACC position.**
- **Do not attempt to tow this vehicle from the front with sling type towing equipment. Damage to the front fascia will result.**
- **Do not push or tow this vehicle with another vehicle as damage to the bumper fascia and trans-axle may result.**

If you must use the accessories (wipers, defrosters, etc.) while being towed, the key must be in the ON position, not the ACC position. Make certain the transaxle remains in NEUTRAL.

#### **Front Wheel Drive (FWD)**

Your vehicle may be towed under the following conditions: The shift lever must be in NEUTRAL, the distance to be traveled must not exceed 15 mi (25 km), and the towing speed must not exceed 25 mph (40 km/h). Exceeding these towing limits may cause a transaxle failure. If the transaxle is not operative, or if the vehicle is to be towed more than 15 mi (25 km), the vehicle must be transported either with a flat bed truck or with the front wheels off the ground.

### All Wheel Drive (AWD)

Your vehicle may be towed under the following conditions: The shift lever must be in NEUTRAL, the distance to be traveled must not exceed 15 mi (25 km), the towing speed must not exceed 25 mph (40 km/h), and both front and rear wheels must be on the ground. Exceeding these towing limits may cause a transaxle failure. If the transaxle is not operative, or if the vehicle is to be towed more than 15 mi (25 km), the vehicle must be transported on a flat bed truck.

### Towing This Vehicle Behind Another Vehicle With A Tow Dolly

#### Front Wheel Drive (FWD)

**Rear towing is not recommended** with the front wheels on the ground, as transaxle damage can result. If rear towing is the only alternative, **a front end dolly must be used**. Proper towing equipment is necessary to prevent damage to the vehicle.

#### All Wheel Drive (AWD)

### CAUTION!

**The manufacturer does not recommend towing an All-Wheel Drive (AWD) on a tow dolly. Vehicle damage may occur.**



# MAINTAINING YOUR VEHICLE

## CONTENTS

---

■ 2.4L Engine Compartment . . . . .	416	■ Maintenance Procedures . . . . .	422
■ 2.7L Engine Compartment . . . . .	417	□ Engine Oil . . . . .	422
■ 3.5L Engine Compartment . . . . .	418	□ Engine Oil Filter . . . . .	426
■ Onboard Diagnostic System — OBD II . . . . .	419	□ Drive Belts — Check Condition And Tension . .	426
□ Loose Fuel Filler Cap Message . . . . .	419	□ Spark Plugs . . . . .	427
■ Emissions Inspection And Maintenance Programs . . . . .	420	□ Engine Air Cleaner Filter . . . . .	427
■ Replacement Parts . . . . .	421	□ Catalytic Converter . . . . .	427
■ Authorized Dealer Service . . . . .	422	□ Maintenance-Free Battery . . . . .	429
		□ Air Conditioner Maintenance . . . . .	431

- A/C Air Filter — If Equipped . . . . . 432
- Power Steering — Fluid Check . . . . . 434
- Front Suspension Ball Joints . . . . . 435
- Steering Linkage . . . . . 435
- Body Lubrication . . . . . 435
- Wiper Blades . . . . . 435
- Windshield Washers/Rear Window Washer . . . 436
- Exhaust System . . . . . 437
- Cooling System . . . . . 438
- Hoses And Vacuum/Vapor Harnesses . . . . . 443
- Fuel System . . . . . 444
- Brake System . . . . . 444
- Automatic Transaxle . . . . . 447
- Front And Rear Wheel Bearings . . . . . 449
- Appearance Care And Protection From Corrosion . . . . . 449
- Cleaning The Cupholders . . . . . 454
- Fuses (Totally Integrated Power Module) . . . . . 455
- Vehicle Storage . . . . . 460
- Replacement Bulbs . . . . . 460
- Bulb Replacement . . . . . 462
  - Low Beam Headlight, High Beam Headlight, Front Turn Signal/Park Light, Side Marker Light . . . . . 462
  - Front Fog Light . . . . . 463
  - Tail/Stop Light, Rear Turn Signal Light, Tail Light, Backup Light . . . . . 464



□ License Plate Light . . . . .	467	□ Engine . . . . .	470
■ Fluids And Capacities . . . . .	468	□ Chassis . . . . .	472
■ Fluids, Lubricants, And Genuine Parts . . . . .	470		

## 2.4L ENGINE COMPARTMENT

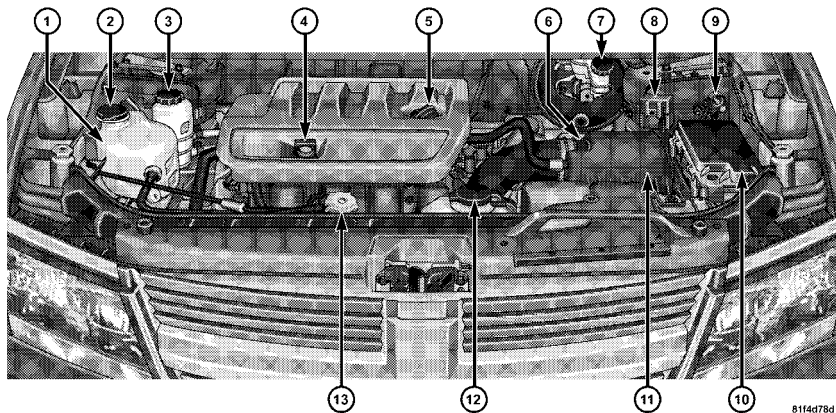

8114d78d

- 1 — Coolant Bottle
- 2 — Engine Coolant Reservoir
- 3 — Power Steering Fluid
- 4 — Engine Oil Dipstick
- 5 — Engine Oil Fill
- 6 — Automatic Transaxle Dipstick
- 7 — Power Steering Fluid Reservoir

- 8 — Remote Jump-Start Positive Battery Post
- 9 — Remote Jump-Start Negative Post
- 10 — Fuses (Totally Integrated Power Module [TIPM])
- 11 — Air Cleaner Filter
- 12 — Washer Fluid Bottle
- 13 — Engine Coolant Cap

## 2.7L ENGINE COMPARTMENT

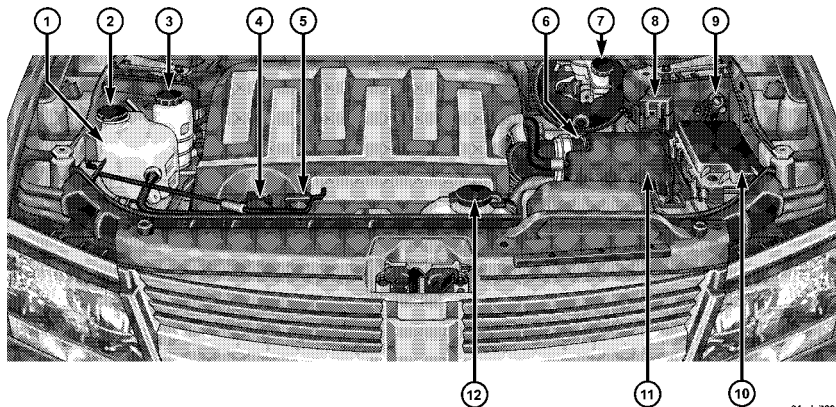

81cda728

- 1 — Coolant Bottle
- 2 — Coolant Pressure Cap
- 3 — Power Steering Fluid
- 4 — Engine Oil Fill
- 5 — Engine Oil Dipstick
- 6 — Automatic Transaxle Dipstick

- 7 — Brake Fluid Reservoir
- 8 — Remote Jump-Start Positive Battery Post
- 9 — Remote Jump-Start Negative Post
- 10 — Fuses (Totally Integrated Power Module [TIPM])
- 11 — Air Cleaner Filter
- 12 — Washer Fluid Bottle

### 3.5L ENGINE COMPARTMENT

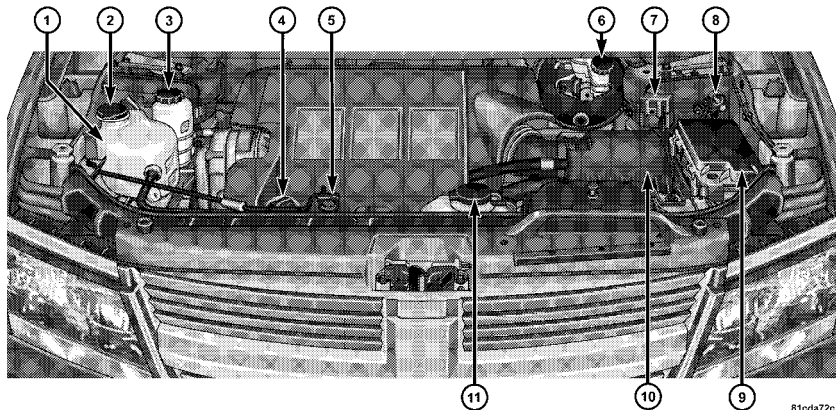

81cda72c

- 1 — Coolant Bottle
- 2 — Coolant Pressure Cap
- 3 — Power Steering Fluid
- 4 — Engine Oil Fill
- 5 — Engine Oil Dipstick
- 6 — Brake Fluid Reservoir

- 7 — Remote Jump-Start Positive Battery Post
- 8 — Remote Jump-Start Negative Post
- 9 — Fuses (Totally Integrated Power Module [TIPM])
- 10 — Air Cleaner Filter
- 11 — Washer Fluid Bottle

## ONBOARD DIAGNOSTIC SYSTEM — OBD II

Your vehicle is equipped with a sophisticated Onboard Diagnostic system called OBD II. This system monitors the performance of the emissions, engine, and automatic transaxle control systems. When these systems are operating properly, your vehicle will provide excellent performance and fuel economy, as well as engine emissions well within current government regulations.

If any of these systems require service, the OBD II system will turn on the Malfunction Indicator Light (MIL). It will also store diagnostic codes and other information to assist your service technician in making repairs. Although your vehicle will usually be drivable and not need towing, see your authorized dealer for service as soon as possible.

### CAUTION!

- **Prolonged driving with the MIL on could cause further damage to the emissions control system. It could also affect fuel economy and driveability. The vehicle must be serviced before any emissions tests can be performed.**
- **If the MIL is flashing while the engine is running, severe catalytic converter damage and power loss will soon occur. Immediate service is required.**

### Loose Fuel Filler Cap Message

If the vehicle diagnostic system determines that the fuel filler cap is loose, improperly installed, or damaged, the word “gASCAP” will display in the odometer. If this occurs, tighten the fuel filler cap until a “clicking” sound is heard and press the TRIP ODOMETER button to turn

off the message. If the problem persists, the message will appear the next time the vehicle is started.

A loose, improperly installed, or damaged fuel filler cap may also turn on the MIL.

## EMISSIONS INSPECTION AND MAINTENANCE PROGRAMS

In some localities, it may be a legal requirement to pass an inspection of this vehicle's emissions control system. Failure to pass could prevent vehicle registration.



For states that require an Inspection and Maintenance (I/M), this check verifies the Malfunction Indicator Light (MIL) is functioning and is not on when the engine is running, and that the OBD II system is ready for testing.

Normally, the OBD II system will be ready. The OBD II system may **not** be ready if the vehicle was recently

serviced, recently had a dead battery, or a battery replacement. If the OBD II system should be determined not ready for the I/M test, the vehicle may fail the test.

This vehicle has a simple ignition key-actuated test, which you can use prior to going to the test station. To check if this vehicle's OBD II system is ready, you must do the following:

1. Insert the ignition key into the ignition switch.
2. Turn the ignition to the ON position, but do not crank or start the engine.
3. If you crank or start the engine, you will have to start this test over.
4. As soon as you turn the ignition key to the ON position, you will see the MIL symbol come on as part of a normal bulb check.

5. Approximately 15 seconds later, one of two things will happen:

a. The MIL will flash for about 10 seconds and then return to being fully illuminated until you turn OFF the ignition key or start the engine. This means that the vehicle's OBD II system is **not ready** and you should **not** proceed to the I/M station.

b. The MIL will not flash at all and will remain fully illuminated until you turn OFF the ignition key or start the engine. This means that the vehicle's OBD II system is **ready**, and you can proceed to the I/M station.

If the OBD II system is **not ready**, you should see an authorized dealer or repair facility. If this vehicle was recently serviced or had a battery failure or replacement, you may need to do nothing more than drive the vehicle

as you normally would in order for the OBD II system to update. A recheck with the above test routine may then indicate that the system is now ready.

Regardless of whether the vehicle's OBD II system is ready or not ready, if the MIL is illuminated during normal vehicle operation, you should have the vehicle serviced before going to the I/M station. The I/M station can fail the vehicle because the MIL is on with the engine running.

## REPLACEMENT PARTS

Use of genuine Mopar® parts for normal/scheduled maintenance and repairs is highly recommended to ensure the designed performance. Damage or failures caused by the use of non-Mopar® parts for maintenance and repairs will not be covered by the manufacturer's warranty.

## AUTHORIZED DEALER SERVICE

Your authorized dealer has the qualified service personnel, special tools, and equipment to perform all service operations in an expert manner. Service manuals are available which include detailed service information for your vehicle. Refer to these service manuals before attempting any procedure yourself.

**NOTE:** Intentional tampering with emissions control systems can result in civil penalties being assessed against you.

### WARNING!

**You can be badly injured working on or around a motor vehicle. Only do service work for which you have the knowledge and the proper equipment. If you have any doubt about your ability to perform a service job, take your vehicle to a competent mechanic.**

## MAINTENANCE PROCEDURES

The pages that follow contain the **required** maintenance services determined by the engineers who designed your vehicle.

Besides the maintenance items for which there are fixed maintenance intervals, there are other items that should operate satisfactorily without periodic maintenance. However, if a malfunction of these items does occur, it could adversely affect the engine or vehicle performance. These items should be inspected if a malfunction is observed or suspected.

### Engine Oil

#### Checking Oil Level

To assure proper engine lubrication, the engine oil must be maintained at the correct level. Check the oil level at regular intervals, such as every fuel stop.



The best time to check the engine oil level is about five minutes after a fully warmed engine is shut off. Do not check oil level before starting the engine after it has sat overnight. Checking engine oil level when the engine is cold will give you an incorrect reading.

Checking the oil while the vehicle is on level ground and only when the engine is hot, will improve the accuracy of the oil level readings. Maintain the oil level between the range markings on the dipstick. Either the range markings consist of a crosshatch zone marked **SAFE** or a crosshatch zone marked with **MIN** at the low end of the range and **MAX** at the high end of the range. Adding 1.0 qt (1.0 l) of oil when the reading is at the low end of the range marking will raise the oil level to the high end of the range marking.

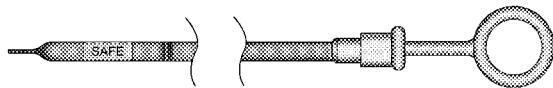

818168a4

**Engine Oil Dipstick**

**CAUTION!**

**Do not overfill the engine. Overfilling the engine will cause oil aeration, which can lead to loss of oil pressure and an increase in oil temperature. This could damage your engine.**

**Change Engine Oil**

The oil change indicator system will remind you that it is time to take your vehicle in for scheduled maintenance. Refer to the Maintenance Schedule in Section 8 for information on this system.

**NOTE:** Under no circumstances should oil change intervals exceed 6,000 mi (10 000 km) or six months, whichever occurs first.

**Engine Oil Selection**

For best performance and maximum protection under all types of operating conditions, the manufacturer only recommends engine oils that are API Certified and meet the requirements of Chrysler Material Standard MS-6395.

**American Petroleum Institute (API) Engine Oil Identification Symbol**

This symbol means that the oil has been certified by the American Petroleum Institute (API). The manufacturer only recommends API Certified engine oils.

**Engine Oil Viscosity (SAE Grade) — 2.4L and 2.7L Engines**

SAE 5W-20 engine oil is recommended for all operating temperatures. This engine oil improves low temperature starting and vehicle fuel economy.

The engine oil filler cap also shows the recommended engine oil viscosity for your engine. For information on engine oil filler cap location, refer to the “Engine Compartment” illustration in this section.

Lubricants that do not have both, the engine oil certification mark and the correct SAE viscosity grade number should not be used.

**Engine Oil Viscosity (SAE Grade) — 3.5L Engine**

SAE 10W-30 engine oil is preferred for use in 3.5L Engines for all operating temperatures.

The engine oil filler cap also shows the recommended engine oil viscosity for your engine. For information on engine oil filler cap location, refer to the “Engine Compartment” illustration in this section.

Lubricants that do not have both, the engine oil certification mark and the correct SAE viscosity grade number should not be used.

**Synthetic Engine Oils**

You may use synthetic engine oils provided the recommended oil quality requirements are met, and the recommended maintenance intervals for oil and filter changes are followed.

**Materials Added to Engine Oil**

The manufacturer strongly recommends against the addition of any additives (other than leak detection dyes) to the engine oil. Engine oil is an engineered product and its performance may be impaired by supplemental additives.

### **Disposing of Used Engine Oil and Oil Filters**

Care should be taken in disposing of used engine oil and oil filters from your vehicle. Used oil and oil filters, indiscriminately discarded, can present a problem to the environment. Contact your authorized dealer, service station, or governmental agency for advice on how and where used oil and oil filters can be safely discarded in your area.

### **Engine Oil Filter**

The engine oil filter should be replaced at every engine oil change.

### **Engine Oil Filter Selection**

This manufacturer's engines have a full-flow type disposable oil filter. Use a filter of this type for replacement. The quality of replacement filters varies considerably. Only high quality filters should be used to assure most efficient service. Mopar® Engine Oil Filters are high quality oil filters and are recommended.

### **Drive Belts — Check Condition and Tension**

Belt tension is controlled by means of an automatic tensioner. Therefore, no belt tension adjustments are required. However, belt and belt tensioner condition should be inspected periodically and replaced if required. Improper belt tension can cause belt slippage and failure. Low generator belt tension can cause battery failure.

Inspect belts for evidence of cuts, cracks, glazing, or frayed cords and replace if there is indication of damage that could result in belt failure. Also, check belt routing to make sure there is no interference between the belts and other engine components. Refer to the Maintenance Schedule in Section 8 for specified service intervals. See your authorized dealer for service.

## Spark Plugs

Spark plugs must fire properly to assure engine performance and emissions control. New plugs should be installed at the specified mileage. The entire set should be replaced if there is any malfunction due to a faulty spark plug. Refer to “Fluids, Lubricants, and Genuine Parts” in this section for the proper type of spark plug for use in your vehicle.

## Engine Air Cleaner Filter

Refer to the Maintenance Schedule in Section 8 for engine air cleaner filter service intervals.

**NOTE:** Be sure to follow the “dusty or off-road conditions” maintenance interval if applicable.

## WARNING!

**The air induction system (air cleaner, hoses, etc.) can provide a measure of protection in the case of engine backfire. Do not remove the air induction system (air cleaner, hoses, etc.) unless such removal is necessary for repair or maintenance. Make sure that no one is near the engine compartment before starting the vehicle with the air induction system (air cleaner, hoses, etc.) removed. Failure to do so can result in serious personal injury.**

## Catalytic Converter

The catalytic converter requires the use of unleaded fuel only. Leaded gasoline will destroy the effectiveness of the catalyst as an emissions control device.

Under normal operating conditions, the catalytic converter will not require maintenance. However, it is important to keep the engine properly tuned to assure proper catalyst operation and prevent possible catalyst damage.

### **CAUTION!**

**Damage to the catalytic converter can result if your vehicle is not kept in proper operating condition. In the event of engine malfunction, particularly involving engine misfire or other apparent loss of performance, have your vehicle serviced promptly. Continued operation of your vehicle with a severe malfunction could cause the converter to overheat, resulting in possible damage to the converter and the vehicle.**

**NOTE:** Intentional tampering with emissions control systems can result in civil penalties being assessed against you.

### **WARNING!**

**A hot exhaust system can start a fire if you park over materials that can burn. Such materials might be grass or leaves coming into contact with your exhaust system. Do not park or operate your vehicle in areas where your exhaust system can contact anything that can burn.**

In unusual situations involving grossly malfunctioning engine operation, a scorching odor may indicate severe and abnormal catalyst overheating. If this occurs, safely bring the vehicle to a complete stop, shut the engine OFF,

and allow the vehicle to cool. Thereafter, obtain service, including a tune-up to manufacturer's specifications immediately.

To minimize the possibility of catalyst damage:

- Do not shut OFF the engine or interrupt the ignition when the transaxle is in gear and the vehicle is in motion.
- Do not try to start the engine by pushing or towing the vehicle.
- Do not idle the engine with any ignition coil connectors disconnected for prolonged periods.

### **Maintenance-Free Battery**

You will never have to add water, nor is periodic maintenance required.

**NOTE:** The battery is stored in a compartment that is located behind the left front fender and is accessible through the wheel well. The wheel and tire assemble do not need to be removed to access the compartment. Remote battery terminals are located in the engine compartment for jump-starting.

To access the battery, turn the steering wheel fully to the right and remove the access panel from the inner fender shield.

**WARNING!**

- **Battery fluid is a corrosive acid solution and can burn or even blind you. Don't allow battery fluid to contact your eyes, skin, or clothing. Don't lean over a battery when attaching clamps. If acid splashes in eyes or on skin, flush the area immediately with large amounts of water.**
- **Battery gas is flammable and explosive. Keep flame or sparks away from the battery. Don't use a booster battery or any other booster source with an output greater than 12 Volts. Don't allow cable clamps to touch each other.**
- **Battery posts, terminals, and related accessories contain lead and lead compounds. Wash hands after handling.**

**CAUTION!**

- **It is essential when replacing the cables on the battery that the positive cable is attached to the positive post and the negative cable is attached to the negative post. Battery posts are marked positive (+) and negative (-) and identified on the battery case. Cable clamps should be tight on the terminal posts and free of corrosion.**
- **If a "fast charger" is used while the battery is in the vehicle, disconnect both vehicle battery cables before connecting the charger to the battery. Do not use a "fast charger" to provide starting voltage as battery damage can result.**



### **Air Conditioner Maintenance**

For best possible performance, your air conditioner should be checked and serviced by an authorized dealer at the start of each warm season. This service should include cleaning of the condenser fins and a performance test. Drive belt tension should also be checked at this time.

#### **WARNING!**

- **Use only refrigerants and compressor lubricants approved by the manufacturer for your air conditioning system. Some unapproved refrigerants are flammable and can explode, injuring you. Other unapproved refrigerants or lubricants can cause the system to fail, requiring costly repairs. Refer to Section 3 of the Warranty Information book for further warranty information.**
- **The air conditioning system contains refrigerant under high pressure. To avoid risk of personal injury or damage to the system, adding refrigerant or any repair requiring lines to be disconnected should be done by an experienced technician.**

### Refrigerant Recovery and Recycling

R-134a Air Conditioning Refrigerant is a hydrofluorocarbon (HFC) that is endorsed by the Environmental Protection Agency and is an ozone-saving product. However, the manufacturer recommends that air conditioning service be performed by authorized dealers or other service facilities using recovery and recycling equipment.

**NOTE:** Use only manufacturer approved A/C system sealers, stop leak products, seal conditioners, compressor oil, and refrigerants.

### A/C Air Filter — If Equipped

Refer to the Maintenance Schedule in Section 8 for A/C air filter service intervals.

### WARNING!

**Do not remove the A/C air filter while the blower is operating or personal injury may result.**

The A/C air filter is located in the fresh air inlet behind the glove box. Perform the following steps to replace the filter:

1. Open the glove box and remove all contents.
2. Push the retaining tab on each side of the glove box inward while gently pulling the glove box door outward until both tabs clear the door opening in the instrument panel.

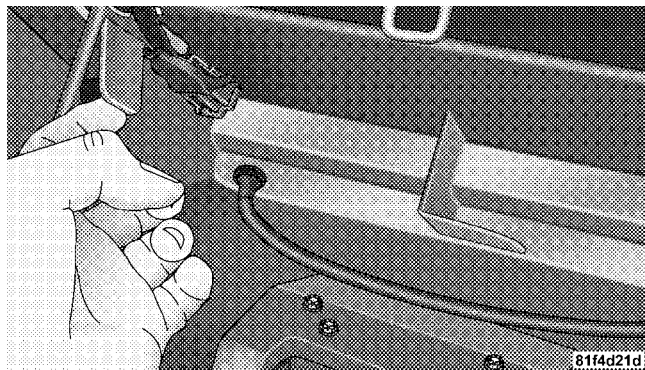

### Glove Box Removal

3. Pivot the glove box downward.
4. Disengage the two retaining tabs that secure the filter cover to the HVAC housing and remove the cover.

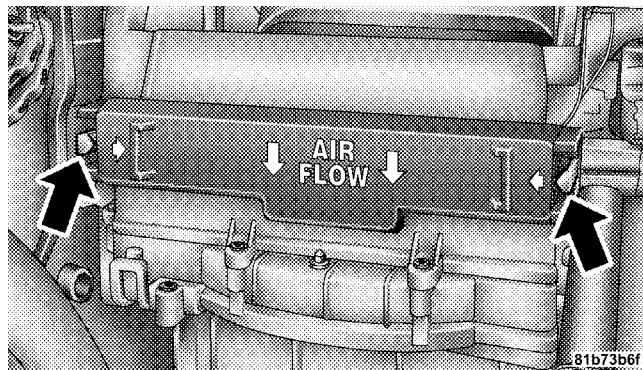

### A/C Air Filter Replacement

5. Remove the A/C air filter by pulling it straight out of the housing.
6. Install the A/C air filter with the arrow on the filter pointing toward the floor. When installing the filter cover, make sure the retaining tabs fully engage the cover.

**CAUTION!**

**The A/C air filter is labeled with an arrow to indicate airflow direction through the filter. Failure to install the filter properly will result in the need to replace it more often.**

7. Reinstall the glove box door. Make sure that the hinges are seated fully as you raise the door. Otherwise, the door latch will not align properly.

**Power Steering — Fluid Check**

Checking the power steering fluid level at a defined service interval is not required. The fluid should only be checked if a leak is suspected, abnormal noises are

apparent, and/or the system is not functioning as anticipated. Coordinate inspection efforts through an authorized dealer. No chemical flushes should be used in any power steering system; only the approved lubricant may be used.

**WARNING!**

**Fluid level should be checked on a level surface and with the engine OFF to prevent injury from moving parts and to ensure accurate fluid level reading. Do not overfill. Use only manufacturer's recommended power steering fluid.**

If necessary, add fluid to restore to the proper indicated level. With a clean cloth, wipe any spilled fluid from all surfaces. Refer to “Fluids, Lubricants, and Genuine Parts” in this section for the correct fluid type.

### Front Suspension Ball Joints

There are two front suspension lower ball joints that are permanently lubricated. Inspect these ball joints when other maintenance is performed. A damaged seal and the corresponding potentially damaged ball joint must be replaced.

### Steering Linkage

The tie rod end ball joints should be inspected for external leakage and damage when other maintenance is performed.

### Body Lubrication

Locks and all body pivot points, including seat tracks, door hinges, liftgate hinges, and hood hinges, should be lubricated periodically to assure quiet, easy operation and to protect against rust and wear. Prior to the application of any lubricant, the parts concerned should be wiped clean to remove dust and grit; after lubricating, excess oil and grease should be removed. Particular

attention should also be given to hood latching components to ensure proper function. When performing other underhood services, the hood latch, release mechanism, and safety catch should be cleaned and lubricated.

The external lock cylinders should be lubricated twice a year, preferably in the Fall and Spring. Apply a small amount of a high quality lubricant such as Mopar® Lock Cylinder Lubricant or equivalent directly into the lock cylinder.

### Wiper Blades

Clean the rubber edges of the wiper blades and the windshield and rear window periodically with a sponge or soft cloth and a mild nonabrasive cleaner. This will remove accumulations of salt, waxes, or road film, and help reduce streaking and smearing.

Operation of the wipers on dry glass for long periods may cause deterioration of the wiper blades. Always use washer fluid when using the wipers to remove salt or dirt from a dry windshield or rear window.

Avoid using the wiper blades to remove frost or ice from the windshield or rear window. Make sure that they are not frozen to the glass before turning them on to avoid damaging the blade. Keep the blade rubber out of contact with petroleum products such as engine oil, gasoline, etc.

**NOTE:** Always refer to the wiper blade packaging for specific installation instructions. Many wiper blade replacements fit multiple vehicles.

### **Windshield Washers/Rear Window Washer**

**NOTE:** Refer to the appropriate “Engine Compartment” diagram in Section 7 for the location of the washer fluid reservoir.

The windshield washer and the rear window washer share the same fluid reservoir. The fluid reservoir is located in the engine compartment. Be sure to check the fluid level in the reservoir at regular intervals. Fill the reservoir with windshield washer solvent (not radiator antifreeze) and operate the system for a few seconds to flush out the residual water.

When refilling the washer fluid reservoir, apply some washer fluid to a cloth or towel and wipe the wiper blades clean. This will help blade performance.

To prevent freeze-up of your windshield washer system in cold weather, select a solution or mixture that meets or exceeds the temperature range of your climate. This rating information can be found on most washer fluid containers.

The fluid reservoir will hold nearly 1 gal (4 l) of washer fluid when the message “LoWASH” appears in the instrument cluster.

**WARNING!**

**Commercially available windshield washer solvents are flammable. They could ignite and burn you. Care must be exercised when filling or working around the washer solution.**

**Exhaust System**

The best protection against carbon monoxide entry into the vehicle body is a properly maintained engine exhaust system.

Whenever a change is noticed in the sound of the exhaust system, when exhaust fumes can be detected inside the vehicle, or when the underside or rear of the vehicle is

damaged, have a competent technician inspect the complete exhaust system and adjacent body areas for broken, damaged, deteriorated, or mispositioned parts. Open seams or loose connections could permit exhaust fumes to seep into the passenger compartment. In addition, inspect the exhaust system each time the vehicle is raised for lubrication or oil change. Replace as required.

**WARNING!**

**Exhaust gases can injure or kill. They contain carbon monoxide (CO), which is colorless and odorless. Breathing it can make you unconscious and can eventually poison you. To avoid breathing CO, refer to "Exhaust Gas" under "Safety Tips" in Section 2.**

## Cooling System

### WARNING!

- **When working near the radiator cooling fan, disconnect the fan motor lead or turn the ignition switch to the LOCK position. The fan is temperature controlled and can start at any time the ignition switch is in the ON position.**
- **You or others can be badly burned by hot coolant or steam from your radiator. If you see or hear steam coming from under the hood, don't open the hood until the radiator has had time to cool. Never try to open a cooling system pressure cap when the radiator is hot.**

### Coolant Checks

Check engine coolant (antifreeze) protection every 12 months (before the onset of freezing weather, where applicable). If coolant is dirty or rusty in appearance, the system should be drained, flushed, and refilled with fresh coolant. Check the front of the A/C condenser for any accumulation of bugs, leaves, etc. If dirty, clean by gently spraying water from a garden hose vertically down the face of the condenser.

Check the coolant recovery bottle tubing for brittle rubber, cracking, tears, cuts, and tightness of the connection at the bottle and radiator. Inspect the entire system for leaks.



### **Cooling System — Drain, Flush, and Refill**

The system should be drained, flushed, and refilled at the intervals shown in the Maintenance Schedule in Section 8.

If the solution is dirty or contains a considerable amount of sediment, clean and flush with a reliable cooling system cleaner. Follow with a thorough rinsing to remove all deposits and chemicals. Properly dispose of old antifreeze solution.

### **Selection of Coolant**

Use only the manufacturer's recommended coolant. Refer to "Fluids, Lubricants, and Genuine Parts" in this section for the correct coolant type.

### **CAUTION!**

- **Mixing of coolants other than specified HOAT engine coolants, may result in engine damage and may decrease corrosion protection. If a non-HOAT coolant is introduced into the cooling system in an emergency, it should be replaced with the specified coolant as soon as possible.**
- **Do not use plain water alone or alcohol-based engine coolant (antifreeze) products. Do not use additional rust inhibitors or antirust products, as they may not be compatible with the radiator engine coolant and may plug the radiator.**
- **This vehicle has not been designed for use with propylene glycol-based coolants. Use of propylene glycol-based coolants is not recommended.**

## Adding Coolant

Your vehicle has been built with an improved engine coolant that allows extended maintenance intervals. This coolant can be used up to five years or 100,000 mi (160 000 km) before replacement. To prevent reducing this extended maintenance period, it is important that you use the same coolant throughout the life of your vehicle. Please review these recommendations for using Hybrid Organic Additive Technology (HOAT) coolant.

When adding coolant:

- The manufacturer recommends using Mopar® Antifreeze/Coolant 5 Year/100,000 Mile Formula HOAT (Hybrid Organic Additive Technology).
- Mix a minimum solution of 50% HOAT engine coolant and distilled water. Use higher concentrations (not to exceed 70%) if temperatures below  $-34^{\circ}\text{F}$  ( $-37^{\circ}\text{C}$ ) are anticipated.

- Use only high purity water such as distilled or deionized water when mixing the water/engine coolant solution. The use of lower quality water will reduce the amount of corrosion protection in the engine cooling system.

Please note that it is the owner's responsibility to maintain the proper level of protection against freezing according to the temperatures occurring in the area where the vehicle is operated.

**NOTE:** Mixing coolant types will decrease the life of the engine coolant and will require more frequent coolant changes.

## Cooling System Pressure Cap

The cap must be fully tightened to prevent loss of coolant, and to ensure that coolant will return to the radiator from the coolant recovery bottle.

The cap should be inspected and cleaned if there is any accumulation of foreign material on the sealing surfaces.

### WARNING!

- **The warning words “DO NOT OPEN HOT” on the cooling system pressure cap are a safety precaution. Never add coolant when the engine is overheated. Do not loosen or remove the cap to cool an overheated engine. Heat causes pressure to build up in the cooling system. To prevent scalding or injury, do not remove the pressure cap while the system is hot or under pressure.**
- **Do not use a pressure cap other than the one specified for your vehicle. Personal injury or engine damage may result.**

### Disposal of Used Coolant

Used ethylene glycol-based engine coolant is a regulated substance requiring proper disposal. Check with your local authorities to determine the disposal rules for your community. To prevent ingestion by animals or children, do not store ethylene glycol-based engine coolant in open containers or allow it to remain in puddles on the ground. If ingested by a child, contact a physician immediately. Clean up any ground spills immediately.

### Coolant Level

**Four Cylinder Engines** — the coolant bottle provides a quick visual method for determining that the coolant level is adequate. With the engine idling and warm to normal operating temperature, the level of the coolant in the bottle should be between the “ADD” and “FULL” lines, shown on the bottle.

**Six Cylinder Engines** — the level of the coolant in the pressurized coolant bottle should be between the “COLD” and “FULL” range on the bottle when the engine is cold.

The radiator normally remains completely full, so there is no need to remove the radiator cap unless checking for coolant freeze point or replacing coolant. Advise your service attendant of this. As long as the engine operating temperature is satisfactory, the coolant bottle need only be checked once a month. When additional coolant is needed to maintain the proper level, it should be added to the coolant bottle. Do not overfill.

### **Points to Remember**

**NOTE:** When the vehicle is stopped after a few miles (kilometers) of operation, you may observe vapor coming from the front of the engine compartment. This is normally a result of moisture from rain, snow, or high

humidity accumulating on the radiator and being vaporized when the thermostat opens, allowing hot coolant to enter the radiator.

If an examination of your engine compartment shows no evidence of radiator or hose leaks, the vehicle may be safely driven. The vapor will soon dissipate.

- Do not overfill the coolant recovery bottle.
- Check coolant freeze point in the radiator and in the coolant recovery bottle. If antifreeze needs to be added, contents of coolant recovery bottle must also be protected against freezing.
- If frequent coolant additions are required, or if the level in the coolant recovery bottle does not drop when the engine cools, the cooling system should be pressure tested for leaks.

- Maintain coolant concentration at 50% HOAT engine coolant (minimum) and distilled water for proper corrosion protection of your engine, which contains aluminum components.
- Make sure that the radiator and coolant recovery bottle overflow hoses are not kinked or obstructed.
- Keep the front of the radiator clean. If your vehicle is equipped with air conditioning, keep the front of the condenser clean, also.
- Do not change the thermostat for Summer or Winter operation. If replacement is ever necessary, install **ONLY** the correct type thermostat. Other designs may result in unsatisfactory coolant performance, poor gas mileage, and increased emissions.

### **Hoses and Vacuum/Vapor Harnesses**

Inspect surfaces of hoses and nylon tubing for evidence of heat and mechanical damage. Hard or soft spots, brittle rubber, cracking, tears, cuts, abrasions, and excessive swelling indicate deterioration of the rubber

Pay particular attention to the hoses nearest to high heat sources such as the exhaust manifold. Inspect hose routing to be sure hoses do not touch any heat source or moving component that may cause heat damage or mechanical wear.

Ensure nylon tubing in these areas has not melted or collapsed

Inspect all hose connections such as clamps and couplings to make sure they are secure and no leaks are present.

Components should be replaced immediately if there is any evidence of wear or damage that could cause failure.

### Fuel System

The Electronic Fuel Injection high-pressure fuel system's hoses and fittings have unique material characteristics that provide adequate sealing and resist attack by deteriorated gasoline.

You are urged to use only the manufacturer's specified hoses and fittings, or their equivalent in material and specification, in any fuel system servicing. It is mandatory to replace any damaged hoses or fittings that have been removed during service. Care should be taken with installing fittings to ensure they are properly installed and fully connected. See your authorized dealer for service.

### Brake System

In order to assure brake system performance, all brake system components should be inspected periodically. Suggested service intervals can be found in the "Maintenance Schedule" in Section 8.

### WARNING!

**Riding the brakes can lead to brake failure and possibly an accident. Driving with your foot resting or riding on the brake pedal can result in abnormally high brake temperatures, excessive lining wear, and possible brake damage. You wouldn't have your full braking capacity in an emergency.**

### Brake and Power Steering Hoses

When servicing the vehicle for scheduled maintenance, inspect the surface of the hoses and nylon tubing for evidence of heat and mechanical damage. Hard and brittle rubber, cracking, tears, cuts, abrasions, and excessive swelling suggest deterioration of the rubber. Particular attention should be made to examining those hose surfaces nearest to high heat sources, such as the exhaust manifold.

Ensure nylon tubing in these areas has not melted or collapsed.

Inspect all hose clamps and couplings to make sure they are secure and no leaks are present.

**NOTE:**

- Often, fluids such as oil, power steering fluid, and brake fluid are used during assembly plant operations to ease the assembly of hoses to couplings. Therefore, oil wetness at the hose-coupling area is not necessarily an indication of leakage. Actual dripping of hot fluid when systems are under pressure (during vehicle operation) should be noted before a hose is replaced based on leakage.
- Inspect the brake hoses whenever the brake system is serviced and at every engine oil change. Inspect hydraulic brake hoses for surface cracking, scuffing, or worn spots. If there is any evidence of cracking, scuffing, or worn spots, the hose should be replaced

immediately. Eventual deterioration of the hose can take place, resulting in a possibility of a burst failure.

**WARNING!**

**Worn brake hoses can burst and cause brake failure. You could have an accident. If you see any signs of cracking, scuffing, or worn spots, have the brake hoses replaced immediately.**

**Master Cylinder - Brake Fluid Level Check**

Check the fluid level in the master cylinder immediately if the Brake System Warning Light indicates system failure.

Check the fluid level in the master cylinder when performing underhood services.

Clean the top of the master cylinder area before removing the cap. If necessary, add fluid to bring the fluid level up to the requirements described on the brake fluid reservoir.

Overfilling of fluid is not recommended because it may cause leaking in the system.

Fluid level can be expected to fall as the brake pads wear. Brake fluid level should be checked when pads are replaced. However, low fluid level may be caused by a leak and a checkup may be needed.

Use only manufacturer's recommended brake fluid. Refer to "Fluids, Lubricants, and Genuine Parts" in this section for the correct fluid type.

### **WARNING!**

- **Overfilling the brake fluid reservoir can result in spilling brake fluid on hot engine parts and the brake fluid catching fire.**
- **Use of a brake fluid that may have a lower initial boiling point, or is unidentified as to specification, may result in sudden brake failure during hard prolonged braking. You could have an accident.**

Use only brake fluid that has been in a tightly closed container to avoid contamination from foreign matter or moisture.



**CAUTION!**

**Do not allow petroleum-based fluid to contaminate the brake fluid. Seal damage may result.**

**Automatic Transaxle**

The automatic transaxle and differential assembly are contained within a single housing.

The fluid level in the automatic transaxle should be checked whenever the vehicle is serviced. Operation with an improper fluid level will greatly reduce the life of the transaxle and the fluid.

**Fluid Level Check — Vehicles with 3.5L Engine**

The automatic transaxle has no dipstick and is dealer serviced only.

**Fluid Level Check — Vehicles with 2.4L and 2.7L Engines**

Use the following procedure to check the automatic transaxle fluid level properly:

1. Park the vehicle on level ground.
2. Run the engine at curb idle speed for a minimum of 60 seconds.
3. Apply the parking brake fully.
4. Place the shift lever momentarily in each gear position ending with the lever in PARK.
5. Wipe the area around the dipstick clean to eliminate the possibility of dirt entering the transaxle.
6. Remove the dipstick and determine if the fluid is hot or cold. Hot fluid is approximately 180°F (82°C), which is the normal operating temperature after the vehicle is

driven at least 15 mi (24 km). Hot fluid cannot be held comfortably between the fingertips. Cold fluid is at a temperature below 80°F (27°C).

7. Wipe the dipstick clean and reinsert until seated. Then, remove dipstick and note the reading.

- a. If the fluid is hot, the reading should be in the crosshatched area marked “HOT” (between the upper two holes in the dipstick).
- b. If the fluid is cold, the fluid level should be between the lower two holes in the area marked “COLD.”

If the fluid level is low, add sufficient fluid through the filler (dipstick) tube to bring it to the proper level. Do not overfill.

### CAUTION!

- **Using a transmission fluid other than the manufacturer’s recommended fluid may cause deterioration in transmission shift quality and/or torque converter shudder. Using a transmission fluid other than that recommended by the manufacturer will result in more frequent fluid and filter changes. Refer to “Fluids, Lubricants, and Genuine Parts” for the correct fluid type.**
- **Dirt and water in the transaxle can cause serious damage. To prevent dirt and water from entering the transaxle after checking or replenishing fluid, make certain that the dipstick cap is re-seated properly.**

### **Fluid and Filter Changes**

Change the automatic transaxle fluid and filter at the intervals shown in the “Maintenance Schedule” in this manual.

In addition, change the fluid and filter if the transaxle is disassembled for any reason.

### **Selection of Lubricant**

It is important that the proper lubricant is used in the transaxle to assure optimum transaxle performance. Use only manufacturer’s recommended transmission fluid. Refer to “Fluids, Lubricants, and Genuine Parts” in this section for the correct fluid type. It is important that the transmission fluid be maintained at the prescribed level using the recommended fluid. No chemical flushes should be used in any transaxle; only the approved lubricant may be used.

### **Special Additives**

Automatic Transmission Fluid (ATF) is an engineered product and its performance may be impaired by supplemental additives. Therefore, do not add any fluid additives to the transaxle. The only exception to this policy is the use of special dyes to aid in detecting fluid leaks. In addition, avoid using transmission sealers as they may adversely affect seals.

### **Front and Rear Wheel Bearings**

Front and rear wheel bearings are permanently sealed. No regular maintenance is required for these components.

### **Appearance Care and Protection from Corrosion**

#### **Protection of Body and Paint from Corrosion**

Vehicle body care requirements vary according to geographic locations and usage. Chemicals that make roads passable in snow and ice and those that are sprayed on trees and road surfaces during other seasons are highly

corrosive to the metal in your vehicle. Outside parking, which exposes your vehicle to airborne contaminants, road surfaces on which the vehicle is operated, extreme hot or cold weather and other extreme conditions will have an adverse effect on paint, metal trim, and underbody protection.

The following maintenance recommendations will enable you to obtain maximum benefit from the corrosion resistance built into your vehicle.

### **What Causes Corrosion?**

Corrosion is the result of deterioration or removal of paint and protective coatings from your vehicle.

The most common causes are:

- Road salt, dirt, and moisture accumulation.
- Stone and gravel impact.
- Insects, tree sap, and tar.

- Salt in the air near seacoast localities.
- Atmospheric fallout/industrial pollutants.

### **Washing**

- Wash your vehicle regularly. Always wash your vehicle in the shade using Mopar® Car Wash or a mild car wash soap, and rinse the panels completely with clear water.
- If insects, tar, or other similar deposits have accumulated on your vehicle, use Mopar® Super Kleen Bug and Tar Remover to remove.
- Use Mopar® Cleaner Wax to remove road film, stains and to protect your paint finish. Take care never to scratch the paint.
- Avoid using abrasive compounds and power buffing that may diminish the gloss or thin out the paint finish.

**CAUTION!**

**Do not use abrasive or strong cleaning materials such as steel wool or scouring powder that will scratch metal and painted surfaces.**

**Special Care**

- If you drive on salted or dusty roads or if you drive near the ocean, hose off the undercarriage at least once a month.
- It is important that the drain holes in the lower edges of the doors, rocker panels, and cargo area be kept clear and open.
- If you detect any stone chips or scratches in the paint, touch them up immediately. The cost of such repairs is considered the responsibility of the owner.

- If your vehicle is damaged due to an accident or similar cause, which destroys the paint and protective coating, have your vehicle repaired as soon as possible. The cost of such repairs is considered the responsibility of the owner.
- If you carry special cargo such as chemicals, fertilizers, de-icer salt, etc., be sure that such materials are well packaged and sealed.
- If a lot of driving is done on gravel roads, consider mud or stone shields behind each wheel.
- Use Mopar® touch up paint on scratches as soon as possible. Your authorized dealer has touch up paint to match the color of your vehicle.

**Wheel and Wheel Trim Care**

All wheels and wheel trim, especially aluminum and chrome plated wheels should be cleaned regularly with a mild soap and water to prevent corrosion. To remove

heavy soil and/or excessive brake dust, use Mopar® Wheel Cleaner (05066247AB) or equivalent or select a nonabrasive, non-acidic cleaner. Do not use scouring pads, steel wool, a bristle brush, or metal polishes. Only Mopar® or equivalent is recommended. Do not use oven cleaner. Avoid automatic car washes that use acidic solutions or harsh brushes that may damage the wheels' protective finish.

## **Interior Care**

### ***Instrument Panel Cover***

The instrument panel cover has a low glare surface, which minimizes reflections in the windshield. Do not use protectants or other products, which may cause undesirable reflections. Use soap and warm water to restore the low glare surface.

### ***Cleaning Interior Trim***

Interior Trim should be cleaned starting with a damp cloth, a damp cloth with Mopar® Total Clean, then

Mopar® Spot & Stain Remover if absolutely necessary. Do not use harsh cleaners or Armorall®. Use Mopar® Total Clean to clean vinyl upholstery

### ***Cleaning Leather Upholstery***

Mopar® Total Clean is specifically recommended for leather upholstery.

Your leather upholstery can be best preserved by regular cleaning with a damp soft cloth. Small particles of dirt can act as an abrasive and damage the leather upholstery and should be removed promptly with a damp cloth. Stubborn soils can be removed easily with a soft cloth and Mopar® Total Clean. Care should be taken to avoid soaking your leather upholstery with any liquid. Please do not use polishes, oils, cleaning fluids, solvents, detergents, or ammonia-based cleaners to clean your leather upholstery. Application of a leather conditioner is not required to maintain the original condition.

**WARNING!**

**Do not use volatile solvents for cleaning purposes. Many are potentially flammable, and if used in closed areas they may cause respiratory harm.**

**YES Essentials® Fabric Cleaning Procedure – If Equipped**

YES Essentials® seats may be cleaned in the following manner:

- Remove as much of the stain as possible by blotting with a clean, dry towel.
- Blot any remaining stain with a clean, damp towel.
- For tough stains, apply Mopar® Total Clean or a mild soap solution to a clean, damp cloth and remove stain. Use a fresh, damp towel to remove soap residue.

- For grease stains, apply Mopar® Multi-Purpose Cleaner to a clean, damp cloth and remove stain. Use a fresh, damp towel to remove soap residue.
- Do not use any solvents or protectants on Yes Essentials® products.

**Cleaning Headlights**

Your vehicle has plastic headlights that are lighter and less susceptible to stone breakage than glass headlights.

Plastic is not as scratch resistant as glass and therefore different lens cleaning procedures must be followed.

To minimize the possibility of scratching the lenses and reducing light output, avoid wiping with a dry cloth. To remove road dirt, wash with a mild soap solution followed by rinsing.

Do not use abrasive cleaning components, solvents, steel wool or other aggressive material to clean the lenses.

### **Glass Surfaces**

All glass surfaces should be cleaned on a regular basis with Mopar® Glass Cleaner or any commercial household-type glass cleaner. Never use an abrasive type cleaner. Use caution when cleaning the inside rear window equipped with an electric defroster. Do not use scrapers or other sharp instruments that may scratch the elements.

When cleaning the rear view mirror, spray cleaner on the towel or rag that you are using. Do not spray cleaner directly on the mirror.

### **Cleaning Plastic Instrument Cluster Lenses**

The lenses in front of the instruments in this vehicle are molded in clear plastic. When cleaning the lenses, care must be taken to avoid scratching the plastic.

1. Clean with a wet soft rag. A mild soap solution may be used, but do not use high alcohol content or abrasive cleaners. If soap is used, wipe clean with a clean damp rag.

2. Dry with a soft tissue.

### **Seat Belt Maintenance**

Do not bleach, dye, or clean the belts with chemical solvents or abrasive cleaners. This will weaken the fabric. Sun damage can also weaken the fabric.

If the belts need cleaning, use a mild soap solution or lukewarm water. Do not remove the belts from the car to wash them.

Replace the belts if they appear frayed or worn or if the buckles do not work properly.

Dry with a soft tissue.

### **Cleaning The Cupholders**

Clean with a damp cloth or towel using a mild detergent.



## FUSES (TOTALLY INTEGRATED POWER MODULE)

The Totally Integrated Power Module (TIPM) is located in the engine compartment near the air cleaner assembly. This center contains fuses and relays.

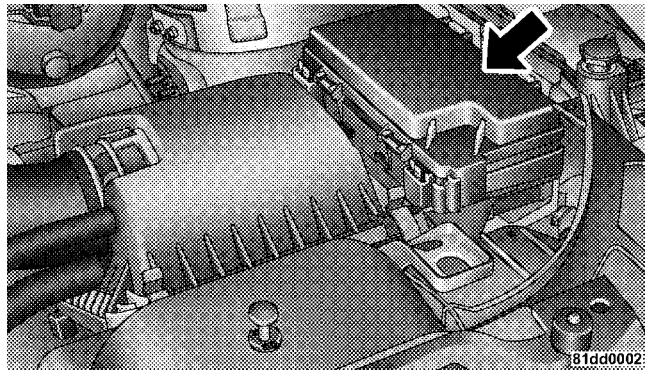

**Totally Integrated Power Module (TIPM)**

### CAUTION!

- When installing the power module cover, it is important to ensure the cover is properly positioned and fully latched. Failure to do so may allow water to get into the TIPM, and possibly result in an electrical system failure.
- When replacing a blown fuse, it is important to use only a fuse having the correct amperage rating. The use of a fuse with a rating other than indicated may result in a dangerous electrical system overload. If a properly rated fuse continues to blow, it indicates a problem in the circuit that must be corrected.

Cavity	Cartridge Fuse	Mini-Fuse	Description
J1	40 Amp Green	—	Power Folding Seat
J2	30 Amp Pink	—	Transfer Case Module - if equipped
J3	30 Amp Pink	—	Rear Door Module
J4	25 Amp White	—	Driver Door Node
J5	25 Amp White	—	Passenger Door Node
J6	40 Amp Green	—	Anti-Lock Brake System (ABS) Pump/Electronic Stability Program (ESP)
J7	30 Amp Pink	—	Anti-Lock Brake System (ABS) Valve/Electronic Stability Program (ESP)
J8	40 Amp Green	—	Power Memory Seat - if equipped

Cavity	Cartridge Fuse	Mini-Fuse	Description
J9	40 Amp Green	—	Flex Fuel/PZEV Motor - if equipped
J10	30 Amp Pink	—	(If Equipped) Headlamp Washer Realy(BUX), Manual Tuning Valve
J11	30 Amp Pink	—	(If Equipped) Sway Bar/Thatchum Security (BUX)/Power Sliding Door
J13	60 Amp Yellow	—	Ignition Off Draw (IOD) Main
J14	40 Amp Green	—	Electric Back Light (EBL)
J15	30 Amp Pink	—	Rear Blower - if equipped
J17	40 Amp Green	—	Starter Solenoid
J18	20 Amp Yellow	—	NGC (Powertrain Control Module)/ Transmission Range

Cavity	Cartridge Fuse	Mini-Fuse	Description
J19	60 Amp Yellow	—	Radiator Fan Motor
J20	30 Amp Pink	—	Front Windshield Wiper Hi/Low
J21	20 Amp Blue	—	Front/Rear Washer
J22	25 Amp White	—	Sunroof Module - if equipped
M1	—	15 Amp Blue	Center High Mounted Stop Light (CHMSL)
M2	—	20 Amp Yellow	(If Equipped) Trailer Lights
M3	—	20 Amp Yellow	Front/Rear Axle
M4	—	10 Amp Red	(If Equipped) Trailer Tow
M5	—	25 Amp Natural	Power Inverter - if equipped

Cavity	Cartridge Fuse	Mini-Fuse	Description
M6	—	20 Amp Yellow	Power Outlet #1/Accessory (ACC) Rain Sensor
M7	—	20 Amp Yellow	Power Outlet #2 (Battery or Accessory (ACC) Selectable)
M8	—	20 Amp Yellow	Front Heated Seats - if equipped
M9	—	20 Amp Yellow	(If Equipped) Rear Heated Seats
M10	—	15 Amp Blue	Vanity Lamps/Hands-Free Module (HFM) - if equipped, Remote Display - if equipped, Satellite Digital Audio Receiver (SDARS) - if equipped, Universal Garage Door Opener (UGDO) - if equipped, Vanity Light, Video Entertainment System (VES) <sup>®</sup> - if equipped

Cavity	Cartridge Fuse	Mini-Fuse	Description
M11	—	10 Amp Red	Automatic Temperature Control (ATC) - if equipped, Underhood Light
M12	—	30 Amp Green	Radio, Amplifier (AMP)
M13	—	20 Amp Yellow	Cabin Compartment Node (CCN), Multifunction Switch/Siren Module
M14	—	20 Amp Yellow	(If Equipped) Trailer Tow (BUX)
M15	—	20 Amp Yellow	Auto Dim Rearview Mirror - if equipped, Infrared Sensor (IR) - if equipped, Multifunction Switch, Tire Pressure Monitor System (TPMS) - if equipped, Transfer Case Module - if equipped,
M16	—	10 Amp Red	Occupant Restraint Controller (ORC)/Occupant Classification Module (OCM)

Cavity	Cartridge Fuse	Mini-Fuse	Description
M17	—	15 Amp Blue	Left Park/Side Marker/Running/Tail Lights, License Lights
M18	—	15 Amp Blue	Right Park/Side Marker/Running/Tail Lights
M19	—	25 Amp Natural	Auto Shut Down (ASD) #1 and #2
M20	—	15 Amp Blue	Electronic Vehicle Information Center (EVIC) - if equipped, Interior Lighting, Steering Wheel Switches - if equipped, Switch Bank
M21	—	20 Amp Yellow	Auto Shut Down (ASD) #3
M22	—	10 Amp Red	Right Horn
M23	—	10 Amp Red	Left Horn
M24	—	25 Amp Natural	Rear Wiper

Cavity	Cartridge Fuse	Mini-Fuse	Description
M25	—	20 Amp Yellow	Fuel Pump/Diesel Lift Pump
M26	—	10 Amp Red	Power MIRRORS Switch/ Drivers Window Switch
M27	—	10 Amp Red	Steering Column Lock, Wireless Ignition Node (WIN)
M28	—	10 Amp Red	NGC (Powertrain Control Module)/Transmission Feed (Batt)
M29	—	10 Amp Red	Occupant Classification Module (OCM)
M30	—	15 Amp Blue	Rear Wiper Module Module/Power Folding Mirror
M31	—	20 Amp Yellow	Back-Up Lights
M32	—	10 Amp Red	Occupant Restraint Controller (ORC)

Cavity	Cartridge Fuse	Mini-Fuse	Description
M33	—	10 Amp Red	NGC (Powertrain Control Module) Battery Feed
M34	—	10 Amp Red	Power Assist Module, HVAC Module, Headlamp Washers, Compass Module - if equipped, Flashlight - if equipped
M35	—	10 Amp Red	Heated Mirrors - if equipped
M36	—	20 Amp Yellow	Power Outlet #3 (Batt)
M37	—	10 Amp Red	Anti-Lock Brake System (ABS), Electronic Stability Program (ESP), STOP LIGHT Switch
M38	—	25 Amp Natural	Lock/Unlock Motors

K1	—	—	Ignition Run/ Accessory Relay
K2	—	—	Ignition Run Relay
K3	—	—	Starter Solenoid Relay
K4	—	—	Ignition Run/Start Relay
K5	—	—	PCM Relay
K6	—	—	Electric Back Light (EBL) Relay
K7	—	—	—
K8	—	—	—
K9	—	—	Rear Blower Relay
K10	—	—	ASD Relay (Feed for M19 and M21)
K11	—	—	Radiator Fan Relay Low Speed

## VEHICLE STORAGE

If you will not be using your vehicle for more than 21 days you may want to take steps to preserve your battery. You may:

- Remove the IOD (Ignition Off-Draw) mini-fuses from the Totally Integrated Power Module located in the engine compartment.
- Or, disconnect the batter negative cable.

## REPLACEMENT BULBS

All the inside bulbs are brass or glass wedge base. Aluminum base bulbs are not approved and should not be used for replacement.

<b>LIGHT BULBS — Interior</b>	<b>Bulb Number</b>
Courtesy/Reading Lights (Incandescent) . . . . .	578
Courtesy/Reading Lights (Optional LED) . . . . .	LED
	(Serviced at Authorized Dealer)
Glove Box Light . . . . .	194
Cargo Light . . . . .	579
Optional Door Map Pocket/ Cupholder Lighting . . . . .	LED
	(Serviced at Authorized Dealer)

**NOTE:** For lighted switches, see your authorized dealer for replacement instructions.

<b>LIGHTS BULBS — Outside</b>	<b>Bulb No.</b>
Low Beam Headlight . . . . .	9006
High Beam Headlight. . . . .	9005
Front Park/Turn Signal . . . . .	3757AK
Side Marker Light . . . . .	168
Front Fog Light . . . . .	9145//H10
Center High Mounted Stop Light (CHMSL) . . . . .	LED
	(Serviced at Authorized Dealer)
Rear Tail/Stop. . . . .	3157K
Rear Turn Signal . . . . .	3757A
Rear Tail. . . . .	3157K
Backup Light. . . . .	3157K
License Light . . . . .	168

## BULB REPLACEMENT

### Low Beam Headlight, High Beam Headlight, Front Turn Signal/Park Light, Side Marker Light

1. Open the hood.

**NOTE:** It may be necessary to remove the air cleaner filter housing and position the Totally Integrated Power Module (TIPM) aside to replace certain the lights in the left headlight housing.

2. Rotate the applicable bulb and connector assembly  $\frac{1}{4}$  turn counterclockwise and remove the assembly from the headlight housing.

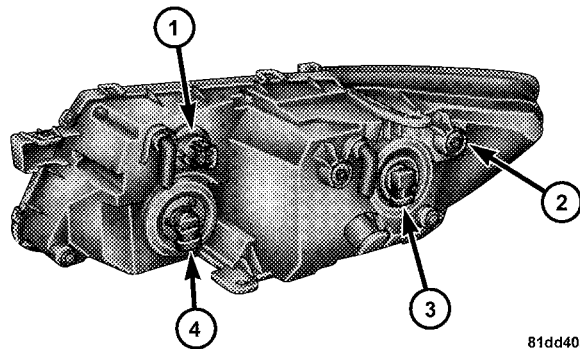

81dd40a9

- 1 — Front Turn Signal/Park Light Bulb
- 2 — Side Marker Light Bulb
- 3 — Low Beam Headlight Bulb
- 4 — High Beam Headlight Bulb

3. Disconnect the bulb from the harness connector and then connect the replacement bulb.



**CAUTION!**

Do not touch the new bulb with your fingers. Oil contamination will severely shorten bulb life. If the bulb comes in contact with any oily surface, clean the bulb with rubbing alcohol.

4. Install the bulb and connector assembly into the headlight housing and rotate it  $\frac{1}{4}$  turn clockwise to lock it in place.

**Front Fog Light**

**NOTE:** Turn the steering wheel to the right if replacing the left front fog light or to the left if replacing the right front fog light to allow for easier access to the front of the wheel well.

1. Remove the fasteners retaining the front lower wheel well access panel and remove the access panel.

2. Rotate the bulb's electrical connector  $\frac{1}{4}$  turn counter-clockwise and remove it from the fog light housing.

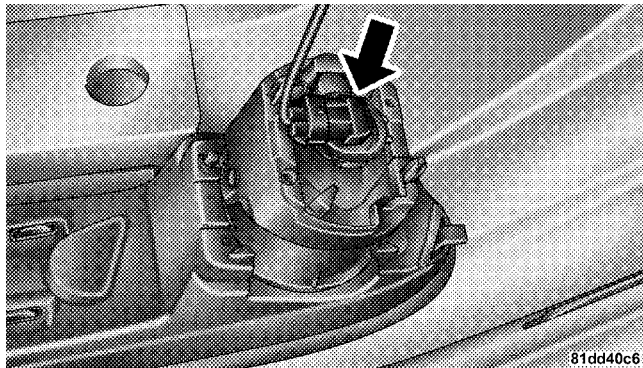

3. Remove the bulb from the connector socket and install the replacement bulb.

**CAUTION!**

**Do not touch the new bulb with your fingers. Oil contamination will severely shorten bulb life. If the bulb comes in contact with an oily surface, clean the bulb with rubbing alcohol.**

4. Install the bulb and connector assembly into the fog light housing and rotate the connector  $\frac{1}{4}$  turn clockwise to lock it in place.
5. Reinstall the front lower wheel well access panel and fasteners.

**Tail/Stop Light, Rear Turn Signal Light, Tail Light, Backup Light**

The taillights are a two-piece design. The tail/stop lights and rear turn signal lights are located in the rear corner body panels. The tail and backup lights are located in the liftgate.

**Changing the Tail/Stop Light or Rear Turn Signal Light**

1. Open the liftgate.
2. Remove the two fasteners from the inboard side of the taillight housing.
3. Carefully insert a trim stick (plastic flat-blade tool) between the body panel and the outboard side of the taillight housing with one hand and grasp the flange on the inboard side of the taillight housing with the other hand. Use the trim stick and hand pressure together to disengage the taillight housing from the vehicle.

4. Rotate the applicable bulb's electrical connector  $\frac{1}{4}$  turn counterclockwise and remove it from the taillight housing.

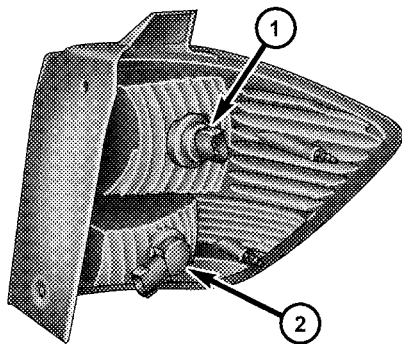

81dd40b0

- 1 — Tail/Stop Light Bulb  
2 — Rear Turn Signal Light Bulb

5. Remove the bulb from the connector socket and install the replacement bulb.

6. Install the bulb and connector assembly into the taillight housing and rotate the connector  $\frac{1}{4}$  turn clockwise to lock it in place.

7. Reinstall the taillight housing and fasteners.

### Changing the Tail Light or Backup Light

1. Open the liftgate.
2. Remove the two fasteners retaining the taillight housing to the liftgate from the inboard face of the liftgate.
3. Carefully insert a trim stick (plastic flat-blade tool) between the taillight housing and the liftgate. Use the trim stick and hand pressure together to disengage the taillight housing from the liftgate.

4. Rotate the applicable bulb's electrical connector  $\frac{1}{4}$  turn counterclockwise and remove it from the housing.

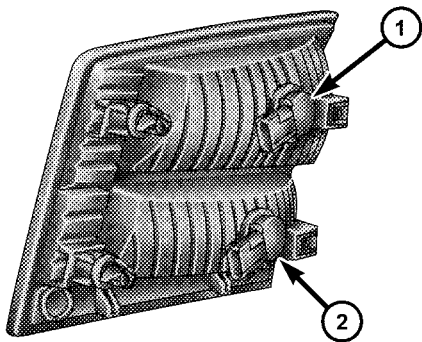

81dd40b7

- 1 — Tail Light Bulb
  - 2 — Backup Light Bulb
- 

5. Remove the bulb from the connector socket and install the replacement bulb.

6. Install the bulb and connector assembly into the housing and rotate the connector  $\frac{1}{4}$  turn clockwise to lock it in place.

7. Reinstall the taillight housing and fasteners.

## License Plate Light

1. Push the small locking tab sticking out of the end of the lens toward the side of the vehicle and hold it in that position.

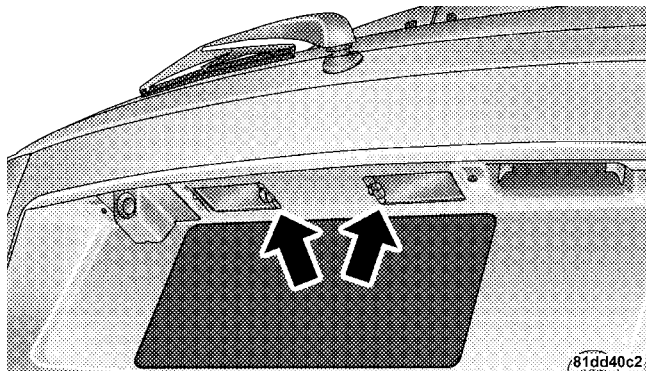

License Light

2. Insert a small flat-blade tool between the end of the lens with the locking tab and the surrounding housing and then pivot the tool to separate the lens from the housing.

3. Hold the lens with one hand and rotate the bulb's electrical connector  $\frac{1}{4}$  turn counterclockwise with the other hand and then separate the bulb and connector assembly from the lens.

4. Remove the bulb from the connector socket and install the replacement bulb.

5. Install the bulb and connector assembly into the lens and rotate the connector  $\frac{1}{4}$  turn clockwise to lock it in place.

6. Insert the end of the lens without the locking tab into the housing on the liftgate and then push the opposite end of the lens into the housing, making sure it locks in the housing.

## FLUIDS AND CAPACITIES

Component	U.S.	Metric
Fuel (approximate)		
Front Wheel Drive (FWD) Models with 2.4 Liter PZEV Engine	18.5 gal	70 l
FWD Models without 2.4 Liter PZEV Engine	20.5 gal	77.6 l
All-Wheel Drive Models	21.1 gal	79.8 l
Engine Oil with Filter		
2.4 Liter Engine (SAE 5W-20, API Certified)	4.5 qts	4.26 l
2.7 Liter Engine (SAE 5W-20, API Certified)	5.5 qts	5.2 l
3.5 Liter Engine (SAE 10W-30, API Certified)	5.5 qts	5.2 l
Cooling System *		
2.4 Liter Engine and Single- or Dual-Zone Climate Control System (Mopar® Antifreeze/Coolant 5 Year/100,000 Mile Formula) or equivalent	7.9 qts	7.5 l
2.4 Liter Engine and Three-Zone Climate Control System (Mopar® Antifreeze/Coolant 5 Year/100,000 Mile Formula) or equivalent	9.8 qts	9.3 l
2.7 Liter Engine and Single- or Dual-Zone Climate Control System (Mopar® Antifreeze/Coolant 5 Year/100,000 Mile Formula) or equivalent	9.8 qts	9.3 l

<b>Component</b>	<b>U.S.</b>	<b>Metric</b>
2.7 Liter Engine and Three-Zone Climate Control System (Mopar® Antifreeze/Coolant 5 Year/100,000 Mile Formula) or equivalent	12 qts	11.4 l
3.5 Liter Engine and Single- or Dual-Zone Climate Control System (Mopar® Antifreeze/Coolant 5 Year/100,000 Mile Formula) or equivalent	9.8 qts	9.3 l
3.5 Liter Engine and Three-Zone Climate Control System (Mopar® Antifreeze/Coolant 5 Year/100,000 Mile Formula) or equivalent	12 qts	11.4 l
* Includes heater and coolant recovery bottle filled to MAX level.		

**FLUIDS, LUBRICANTS, AND GENUINE PARTS****Engine**

<b>Component</b>	<b>Fluids, Lubricants, and Genuine Parts</b>
Engine Coolant	Mopar® Antifreeze/Coolant 5 Year/100,000 Mile Formula HOAT (Hybrid Organic Additive Technology) or equivalent
Engine Oil (2.4L)	Use API Certified SAE 5W-20 Engine Oil meeting the requirements of Chrysler Material Standard MS-6395. Refer to the engine oil fill cap for correct SAE grade.
Engine Oil (2.7L)	Use API Certified SAE 5W-20 Engine Oil meeting the requirements of Chrysler Material Standard MS-6395. Refer to the engine oil fill cap for correct SAE grade.
Engine Oil (3.5L)	Use API Certified SAE 10W-30 Engine Oil meeting the requirements of Chrysler Material Standard MS-6395. Refer to the engine oil fill cap for correct SAE grade.
Oil Filter (2.4L)	Mopar® 04884900AB or equivalent
Oil Filter (2.7L)	Mopar® 04884899AB or equivalent
Oil Filter (3.5L)	Mopar® 04884899AB or equivalent
Spark Plugs (2.4L)	ZFR5F-11 (Gap.044 in [1.12 mm])



<b>Component</b>	<b>Fluids, Lubricants, and Genuine Parts</b>
Spark Plugs (2.7L)	RE14PMC5 (Gap.050 in [1.27 mm])
Spark Plugs (3.5L)	ZFR5LP-13G (Gap.050 in [1.27 mm])
Fuel Selection (2.4L)	87 Octane
Fuel Selection (2.7L)	87 Octane
Fuel Selection (2.7L - EXCEPT CALIFORNIA EMISSION STATES)	E-85 Ethanol
Fuel Selection (3.5L)	87 to 89 Octane

**Chassis**

<b>Component</b>	<b>Fluids, Lubricants and Genuine Parts</b>
Automatic Transaxle	Mopar® ATF+4 Automatic Transmission Fluid
Power Transfer Unit (PTU)	Mopar® Gear Lubricant 75W-90 or equivalent
Rear Drive Assembly (RDA)	Mopar® Gear Lubricant 75W-90 or equivalent.
Brake Master Cylinder	Mopar® DOT 3, SAE J1703 or equivalent should be used. If DOT 3 brake fluid is not available, then DOT 4 is acceptable. Use only recommended brake fluids.
Power Steering Reservoir	Mopar® Power Steering Fluid + 4, Mopar® ATF+4 Automatic Transmission Fluid

# MAINTENANCE SCHEDULES

## CONTENTS

---

■ Emissions Control System Maintenance . . . . .	474	□ Maintenance Service Schedule . . . . .	477
■ Maintenance Schedule . . . . .	474		

### EMISSIONS CONTROL SYSTEM MAINTENANCE

The Scheduled Maintenance services listed in **bold type**, must be done at the times or mileages specified to ensure the continued proper functioning of the Emissions Control System. These, and all other maintenance services included in this manual, should be done to provide best vehicle performance and reliability. More frequent maintenance may be needed for vehicles in severe operating conditions, such as dusty areas and very short trip driving.

Inspection and service should also be done anytime a malfunction is suspected.

**NOTE:** Maintenance, replacement, or repair of the emissions control devices and systems on your vehicle may be performed by any automotive repair establishment or individual using any automotive part that has been certified pursuant to U.S. EPA or in the State of California, California Air Resources Board regulations.

### MAINTENANCE SCHEDULE

The oil change indicator system will remind you that it is time to take your vehicle in for scheduled maintenance.

On Electronic Vehicle Information Center (EVIC) equipped vehicles, “Oil Change Required” will be displayed in the EVIC and a single chime will sound, indicating that an oil change is necessary.

On Non-EVIC equipped vehicles, “Change Oil” will flash in the instrument cluster odometer and a single chime will sound, indicating that an oil change is necessary.

Based on engine operation conditions, the oil change indicator message will illuminate. This means that service is required for your vehicle. Have your vehicle serviced as soon as possible, within the next 500 mi (805 km).

**NOTE:**

- The oil change indicator message will not monitor the time since the last oil change. Change your vehicles oil if it has been six months since your last oil change, even if the oil change indicator message is NOT illuminated.
- Change your engine oil more often if you drive your vehicle off-road for an extended period of time.
- Under no circumstances should oil change intervals exceed 6,000 mi (10,000 km) or six months, whichever comes first.

Your authorized dealer will reset the oil change indicator message after completing the scheduled oil change. If this scheduled oil change is performed by someone other than your authorized dealer, the message can be reset by referring to the steps described under “Oil Change Required” under “Electronic Vehicle Information Center (EVIC)” in Section 4 or under “Odometer/Trip Odometer” under “Instrument Cluster Descriptions” in Section 4.

### *At Each Stop for Fuel*

- Check the engine oil level. Refer to “Engine Oil” under “Maintenance Procedures” in Section 7.
- Check the windshield washer solvent and add if required.

### *Once a Month*

- Check tire pressure and look for unusual wear or damage.
- Inspect the battery, and clean and tighten the terminals as required.
- Check the fluid levels of coolant reservoir, brake master cylinder, power steering, and transaxle, and add as needed.
- Check all lights and other electrical items for correct operation.

### *At Each Oil Change*

- Change the engine oil filter.
- Inspect the brake hoses and lines.

#### **CAUTION!**

**Failure to perform the required maintenance items may result in damage to the vehicle.**

#### **WARNING!**

**You can be badly injured working on or around a motor vehicle. Do only service work for which you have the knowledge and the right equipment. If you have any doubt about your ability to perform a service job, take your vehicle to a competent mechanic.**

**6,000 Miles (10,000 km) or 6 Months Maintenance Service Schedule**

- Change the engine oil and engine oil filter.
- Rotate the tires.

\_\_\_\_\_ Date

\_\_\_\_\_ Dealer Code

\_\_\_\_\_  
Signature Authorized Chrysler Dealer

**12,000 Miles (20,000 km) or 12 Months Maintenance Service Schedule**

- Change the engine oil and engine oil filter.
- Rotate the tires.
- If using your vehicle in dusty or off-road conditions, inspect the engine air cleaner filter, and replace if necessary.
- Inspect the brake linings, and replace if necessary.
- Replace the air conditioning filter (if equipped).
- Inspect the CV joints.  
Perform the first inspection at 12,000 miles (20,000 km) or 12 months.
- Inspect the exhaust system.  
Perform the first inspection at 12,000 miles (20,000 km) or 12 months.

\_\_\_\_\_ Date

\_\_\_\_\_ Dealer Code

\_\_\_\_\_  
Signature Authorized Chrysler Dealer

**18,000 Miles (30,000 km) or 18 Months Maintenance Service Schedule**

- Change the engine oil and engine oil filter.
- Rotate the tires.

\_\_\_\_\_ Date

\_\_\_\_\_ Dealer Code

\_\_\_\_\_  
Signature Authorized Chrysler Dealer

**478 MAINTENANCE SCHEDULES**

**24,000 Miles (40,000 km) or 24 Months  
Maintenance Service Schedule**

- Change the engine oil and engine oil filter.
- Rotate the tires.
- If using your vehicle in dusty or off-road conditions, inspect the engine air cleaner filter, and replace if necessary.
- Inspect the brake linings, and replace if necessary.
- Replace the air conditioning filter (if equipped).
- Inspect the CV joints.
- Inspect the exhaust system.
- Inspect the front suspension, tie rod ends and boot seals, and replace if necessary.

\_\_\_\_\_ Date

\_\_\_\_\_ Dealer Code

\_\_\_\_\_ Signature Authorized Chrysler Dealer

**30,000 Miles (50,000 km) or 30 Months  
Maintenance Service Schedule**

- Change the engine oil and engine oil filter.
- Rotate the tires.
- Replace the engine air cleaner filter if not done at 24,000 miles (40,000 km) or 24months.
- Replace the spark plugs on 2.4L engines.

\_\_\_\_\_ Date

\_\_\_\_\_ Dealer Code

\_\_\_\_\_ Signature Authorized Chrysler Dealer

**36,000 Miles (60,000 km) or 36 Months  
Maintenance Service Schedule**

- Change the engine oil and engine oil filter.
- Rotate the tires.
- If using your vehicle in dusty or off-road conditions, inspect the engine air cleaner filter, and replace if necessary.
- Inspect the brake linings, and replace if necessary.
- Replace the air conditioning filter (if equipped).

\_\_\_\_\_ Date

\_\_\_\_\_ Dealer Code

\_\_\_\_\_ Signature Authorized Chrysler Dealer



**42,000 Miles (70,000 km) or 42 Months  
Maintenance Service Schedule**

- Change the engine oil and engine oil filter.
- Rotate the tires.

\_\_\_\_\_ Date  
Odometer Reading

\_\_\_\_\_ Dealer Code  
Repair Order #

\_\_\_\_\_  
Signature Authorized Chrysler Dealer

**48,000 Miles (80,000 km) or 48 Months  
Maintenance Service Schedule**

- Change the engine oil and engine oil filter.
- Rotate the tires.
- If using your vehicle in dusty or off-road conditions, inspect the engine air cleaner filter, and replace if necessary.
- Inspect the brake linings, and replace if necessary.
- Replace the air conditioning filter (if equipped).
- Inspect the CV joints.
- Inspect the exhaust system.
- Inspect the front suspension, tie rod ends and boot seals, and replace if necessary.

\_\_\_\_\_ Date  
Odometer Reading

\_\_\_\_\_ Dealer Code  
Repair Order #

\_\_\_\_\_  
Signature Authorized Chrysler Dealer

**54,000 Miles (90,000 km) or 54 Months  
Maintenance Service Schedule**

- Change the engine oil and engine oil filter.
- Rotate the tires.

\_\_\_\_\_ Date  
Odometer Reading

\_\_\_\_\_ Dealer Code  
Repair Order #

\_\_\_\_\_  
Signature Authorized Chrysler Dealer

**480 MAINTENANCE SCHEDULES**

**60,000 Miles (100,000 km) or 60 Months  
Maintenance Service Schedule**

- Change the engine oil and engine oil filter.
- Rotate the tires.
- Inspect the brake linings, and replace if necessary.
- Replace the air conditioning filter (if equipped).
- Replace the engine air cleaner filter.
- Replace the spark plugs on 2.4L engines.
- Change rear drive assembly (RDA) fluid.
- Change power transfer unit (PTU) fluid.
- Change the automatic transmission fluid and filter if using your vehicle for any of the following: police, taxi, fleet or frequent trailer towing.
- Flush and replace the engine coolant at 60 months if not done at 102,000 miles (170,000 km).

\_\_\_\_\_ Date

\_\_\_\_\_ Dealer Code

\_\_\_\_\_ Signature Authorized Chrysler Dealer

**66,000 Miles (110,000 km) or 66 Months  
Maintenance Service Schedule**

- Change the engine oil and engine oil filter.
- Rotate the tires.

\_\_\_\_\_ Date

\_\_\_\_\_ Dealer Code

\_\_\_\_\_ Signature Authorized Chrysler Dealer

**72,000 Miles (120,000 km) or 72 Months Maintenance Service Schedule**

- Change the engine oil and engine oil filter.
- Rotate the tires.
- If using your vehicle in dusty or off-road conditions, inspect the engine air cleaner filter, and replace if necessary.
- Inspect the brake linings, and replace if necessary.
- Inspect the CV joints.
- Inspect the exhaust system.
- Replace the air conditioning filter (if equipped).
- Inspect the front suspension, tie rod ends and boot seals, and replace if necessary.

\_\_\_\_\_ Date  
Odometer Reading

\_\_\_\_\_ Dealer Code  
Repair Order #

\_\_\_\_\_  
Signature Authorized Chrysler Dealer

**78,000 Miles (130,000 km) or 78 Months Maintenance Service Schedule**

- Change the engine oil and engine oil filter.
- Rotate the tires.

\_\_\_\_\_ Date  
Odometer Reading

\_\_\_\_\_ Dealer Code  
Repair Order #

\_\_\_\_\_  
Signature Authorized Chrysler Dealer

**84,000 Miles (140,000 km) or 84 Months Maintenance Service Schedule**

- Change the engine oil and engine oil filter.
- Rotate the tires.
- If using your vehicle in dusty or off-road conditions, inspect the engine air cleaner filter, and replace if necessary.
- Inspect the brake linings, and replace if necessary.
- Replace the air conditioning filter (if equipped).

\_\_\_\_\_ Date  
Odometer Reading

\_\_\_\_\_ Dealer Code  
Repair Order #

\_\_\_\_\_  
Signature Authorized Chrysler Dealer

**482 MAINTENANCE SCHEDULES**

**90,000 Miles (150,000 km) or 90 Months  
Maintenance Service Schedule**

- Change the engine oil and engine oil filter.
- Rotate the tires.
- Replace the engine air cleaner filter if not done at 84,000 miles (140,000 km) or 84 months.
- Replace the spark plugs on 2.4L engines.
- Inspect and replace PCV valve if necessary.\*

\* This maintenance is recommended by the manufacturer to the owner, but is not required to maintain emissions warranty

\_\_\_\_\_ Date  
Odometer Reading

\_\_\_\_\_ Dealer Code  
Repair Order #

\_\_\_\_\_  
Signature Authorized Chrysler Dealer

**96,000 Miles (160,000 km) or 96 Months  
Maintenance Service Schedule**

- Change the engine oil and engine oil filter.
- Rotate the tires.
- If using your vehicle in dusty or off-road conditions, inspect the engine air cleaner filter, and replace if necessary.
- Inspect the brake linings, and replace if necessary.
- Replace the air conditioning filter (if equipped).
- Inspect the CV joints.
- Inspect the exhaust system.
- Inspect the front suspension, tie rod ends and boot seals, and replace if necessary.

\_\_\_\_\_ Date  
Odometer Reading

\_\_\_\_\_ Dealer Code  
Repair Order #

\_\_\_\_\_  
Signature Authorized Chrysler Dealer

**102,000 Miles (170,000 km) or  
102 Months  
Maintenance Service Schedule**

- Change the engine oil and engine oil filter.
- Rotate the tires.
- Flush and replace the engine coolant if not done at 60 months.
- Replace the spark plugs on 2.7L and 3.5L engines.
- Replace the timing belt on 3.5L engines.

\_\_\_\_\_ Date  
Odometer Reading

\_\_\_\_\_ Dealer Code  
Repair Order #

\_\_\_\_\_  
Signature Authorized Chrysler Dealer

**108,000 Miles (180,000 km) or  
108 Months  
Maintenance Service Schedule**

- Change the engine oil and engine oil filter.
- Rotate the tires.
- If using your vehicle in dusty or off-road conditions, inspect the engine air cleaner filter, and replace if necessary.
- Inspect the brake linings, and replace if necessary.
- Replace the air conditioning filter (if equipped).

\_\_\_\_\_ Date  
Odometer Reading

\_\_\_\_\_ Dealer Code  
Repair Order #

\_\_\_\_\_  
Signature Authorized Chrysler Dealer

**114,000 Miles (190,000 km) or 114 Months  
Maintenance Service Schedule**

- Change the engine oil and engine oil filter.
- Rotate the tires.

\_\_\_\_\_ Date  
Odometer Reading

\_\_\_\_\_ Dealer Code  
Repair Order #

\_\_\_\_\_  
Signature Authorized Chrysler Dealer

484 MAINTENANCE SCHEDULES

**120,000 Miles (200,000 km) or 120 Months  
Maintenance Service Schedule**

- Change the engine oil and engine oil filter.
- Rotate the tires.
- Inspect the brake linings, and replace if necessary.
- Replace the air conditioning filter (if equipped).
- Inspect the CV joints.
- Inspect the exhaust system.
- Inspect the front suspension, tie rod ends and boot seals, and replace if necessary.
- Replace the engine air cleaner filter.
- Replace the spark plugs on 2.4L engines.
- Change rear drive assembly (RDA) fluid.
- Change power transfer unit (PTU) fluid.
- Change the automatic transmission fluid and filter.
- Replace the accessory drive belt(s).

\_\_\_\_\_ Date

\_\_\_\_\_ Dealer Code

\_\_\_\_\_ Signature Authorized Chrysler Dealer

# IF YOU NEED CONSUMER ASSISTANCE

## CONTENTS

---

■ Suggestions For Obtaining Service For Your Vehicle . . . . .	487	□ Customer Assistance For The Hearing Or Speech Impaired (TDD/TTY) . . . . .	489
□ Prepare For The Appointment . . . . .	487	□ Service Contract . . . . .	489
□ Prepare A List . . . . .	487	■ Warranty Information (U.S. Vehicles Only) . . . . .	490
□ Be Reasonable With Requests . . . . .	487	■ MOPAR®Parts . . . . .	491
■ If You Need Assistance . . . . .	487	■ Reporting Safety Defects . . . . .	491
□ Chrysler LLC Customer Center . . . . .	488	□ In The 50 United States And Washington, D.C. . . . .	491
□ Chrysler Canada Inc. Customer Center . . . . .	488	□ In Canada . . . . .	491
□ In Mexico Contact . . . . .	489		

- Publication Order Forms . . . . .492
- Department Of Transportation Uniform  
Tire Quality Grades . . . . .493
  - Treadwear . . . . .493

- Traction Grades . . . . .493
- Temperature Grades . . . . .494



## **SUGGESTIONS FOR OBTAINING SERVICE FOR YOUR VEHICLE**

### **Prepare For The Appointment**

If you're having warranty work done, be sure to have the right papers with you. Take your warranty folder. All work to be performed may not be covered by the warranty. Discuss additional charges with the service manager. Keep a maintenance log of your vehicle's service history. This can often provide a clue to the current problem.

### **Prepare A List**

Make a written list of your vehicle's problems or the specific work you want done. If you've had an accident or work done that is not on your maintenance log, let the service advisor know.

### **Be Reasonable With Requests**

If you list a number of items and you must have your vehicle by the end of the day, discuss the situation with the service advisor and list the items in order of priority. At many authorized dealers, you may obtain a rental vehicle at a minimal daily charge. If you need a rental, it is advisable to make these arrangements when you call for an appointment.

### **IF YOU NEED ASSISTANCE**

The manufacturer and its authorized dealers are vitally interested in your satisfaction. We want you to be happy with our products and services.

Warranty service must be done by an authorized dealer. We strongly recommend that you take the vehicle to an authorized selling dealer. They know you and the vehicle best, and are most concerned that you get prompt and

high quality service. The manufacturer's authorized dealers have the facilities, factory-trained technicians, special tools, and the latest information to ensure the vehicle is fixed correctly and in a timely manner.

This is why you should always talk to an authorized dealer's service manager first. Most matters can be resolved with this process.

- If for some reason you are still not satisfied, talk to the general manager or owner of the authorized dealership. They want to know if you need assistance.
- If an authorized dealership is unable to resolve the concern, you may contact the Manufacturer's Customer Center.

Any communication to the Manufacturer's Customer Center should include the following information:

- Owner's name and address

- Owner's telephone number (home and office)
- Authorized dealership name
- Vehicle Identification Number (VIN)
- Vehicle delivery date and mileage

#### **Chrysler LLC Customer Center**

P.O. Box 21-8004

Auburn Hills, MI 48321-8004

Phone: (800) 992-1997

#### **Chrysler Canada Inc. Customer Center**

P.O. Box 1621

Windsor, Ontario N9A 4H6

Phone: (800) 465-2001

**In Mexico contact:**

Av. Prolongacion Paseo de la Reforma, 1240

Sante Fe C.P. 05109

Mexico, D. F.

In Mexico City: 5081-4568

Outside Mexico City: 1-800-505-1300

**Customer Assistance For The Hearing Or Speech Impaired (TDD/TTY)**

To assist customers who have hearing difficulties, the manufacturer has installed special TDD (Telecommunication Devices for the Deaf) equipment at its Customer Center. Any hearing or speech impaired customer, who has access to a TDD or a conventional teletypewriter (TTY) in the United States, can communicate with the manufacturer by dialing 1-800-380-CHRY.

**Service Contract**

You may have purchased a service contract for an vehicle to help protect you from the high cost of unexpected repairs after the manufacturer's New Vehicle Limited Warranty expires. The manufacturer stands behind only the manufacturer's Service Contracts. If you purchased a manufacturer's Service Contract, you will receive Plan Provisions and an Owner Identification Card in the mail within three weeks of the vehicle delivery date. If you have any questions about the service contract, call the manufacturer's Service Contract National Customer Hotline at 1-800-521-9922.

The manufacturer will not stand behind any service contract that is not the manufacturer's Service Contract. It is not responsible for any service contract other than the manufacturer's Service Contract. If you purchased a service contract that is not a manufacturer's Service

Contract, and you require service after the manufacturer's New Vehicle Limited Warranty expires, please refer to the contract documents, and contact the person listed in those documents.

We appreciate that you have made a major investment when you purchased the vehicle. An authorized dealer has also made a major investment in facilities, tools, and training to assure that you are absolutely delighted with the ownership experience. You'll be pleased with their sincere efforts to resolve any warranty issues or related concerns.

**WARNING!**

**Engine exhaust, some of its constituents, and certain vehicle components contain, or emit, chemicals known to the State of California to cause cancer and birth defects or other reproductive harm. In addition, certain fluids contained in vehicles and certain products of component wear contain, or emit, chemicals known to the State of California to cause cancer and birth defects or other reproductive harm.**

**WARRANTY INFORMATION (U.S. Vehicles Only)**

See the Warranty Information Booklet for the terms and provisions of Chrysler LLC warranties applicable to this vehicle.

## **MOPAR® PARTS**

Mopar® fluids, lubricants, parts, and accessories are available from an authorized dealer. They will help keep the vehicle operating at its best.

## **REPORTING SAFETY DEFECTS**

### **In The 50 United States And Washington, D.C.**

If you believe that your vehicle has a defect that could cause a crash or cause injury or death, you should immediately inform the National Highway Traffic Safety Administration (NHTSA) in addition to notifying the manufacturer.

If NHTSA receives similar complaints, it may open an investigation, and if it finds that a safety defect exists in a group of vehicles, it may order a recall and remedy campaign. However, NHTSA cannot become involved in individual problems between you, your authorized dealer, and the manufacturer.

To contact NHTSA, you may either call the Auto Safety Hotline toll free at 1-888-327-4236 (TTY: 1-800-424-9153), or go to <http://www.safercar.gov>; or write to: Administrator, NHTSA, 400 Seventh Street, SW., Washington, D.C. 20590. You can also obtain other information about motor vehicle safety from <http://www.safercar.gov>.

### **In Canada**

If you believe that your vehicle has a safety defect, you should contact the Customer Service Department immediately. Canadian customers who wish to report a safety defect to the Canadian government should write to: Transport Canada, Motor Vehicle Defect Investigations and Recalls, 2780 Sheffield Road, Ottawa, Ontario K1B 3V9.

## PUBLICATION ORDER FORMS

To order the following manuals, you may use either the website or the phone numbers listed below. Visa, Mastercard, American Express, and Discover orders are accepted. If you prefer mailing your payment, please call for an order form.

**NOTE:** A street address is required when ordering manuals (no P.O. Boxes).

- *Service Manuals*

These comprehensive Service Manuals provide the information that students and professional technicians need in diagnosing/troubleshooting, problem solving, maintaining, servicing, and repairing Chrysler LLC vehicles. A complete working knowledge of the vehicle, system, and/or components is written in straightforward language with illustrations, diagrams, and charts.

- *Diagnostic Procedure Manuals*

Diagnostic Procedure Manuals are filled with diagrams, charts and detailed illustrations. These practical manuals make it easy for students and technicians to find and fix problems on computer-controlled vehicle systems and features. They show exactly how to find and correct problems the first time, using step-by-step troubleshooting and drivability procedures, proven diagnostic tests and a complete list of all tools and equipment.

- *Owner's Manuals*

These Owner's Manuals have been prepared with the assistance of service and engineering specialists to acquaint you with specific Chrysler LLC vehicles. Included are starting, operating, emergency and maintenance procedures as well as specifications, capabilities and safety tips.

**Call toll free at:**

- 1-800-890-4038 (U.S.)
- 1-800-387-1143 (Canada)

Or

**Visit us on the Worldwide Web at:**

- [www.techauthority.com](http://www.techauthority.com)

**DEPARTMENT OF TRANSPORTATION UNIFORM  
TIRE QUALITY GRADES**

The following tire grading categories were established by the National Highway Traffic Safety Administration. The specific grade rating assigned by the tire's manufacturer in each category is shown on the sidewall of the tires on your vehicle.

All passenger car tires must conform to Federal safety requirements in addition to these grades.

**Treadwear**

The Treadwear grade is a comparative rating, based on the wear rate of the tire when tested under controlled conditions on a specified government test course. For example, a tire graded 150 would wear one and one-half times as well on the government course as a tire graded 100. The relative performance of tires depends upon the actual conditions of their use, however, and may depart significantly from the norm due to variations in driving habits, service practices, and differences in road characteristics and climate.

**Traction Grades**

The Traction grades, from highest to lowest, are AA, A, B, and C. These grades represent the tire's ability to stop on wet pavement, as measured under controlled conditions on specified government test surfaces of asphalt and concrete. A tire marked C may have poor traction performance.

**WARNING!**

**The traction grade assigned to this tire is based on straight-ahead braking traction tests, and does not include acceleration, cornering, hydroplaning, or peak traction characteristics.**

**Temperature Grades**

The temperature grades are A (the highest), B, and C, representing the tire's resistance to the generation of heat and its ability to dissipate heat, when tested under controlled conditions on a specified indoor laboratory test wheel. Sustained high temperature can cause the material of the tire to degenerate and reduce tire life, and excessive temperature can lead to sudden tire failure. The grade C corresponds to a level of performance, which all passenger car tires must meet under the Federal Motor

Vehicle Safety Standard No. 109. Grades B and A represent higher levels of performance on the laboratory test wheel, than the minimum required by law.

**WARNING!**

**The temperature grade for this tire is established for a tire that is properly inflated and not overloaded. Excessive speed, under-inflation, or excessive loading, either separately or in combination, can cause heat buildup and possible tire failure.**



---

# INDEX

- About Your Brakes . . . . . 318,321
- ABS (Anti-Lock Brake System) . . . . . 212,322,323
- Adding Engine Coolant (Antifreeze) . . . . . 440
- Adding Fuel . . . . . 367
- Adding Rear Washer Fluid . . . . . 192
- Adding Washer Fluid . . . . . 155,192,436
- Additives, Fuel . . . . . 366
- Air Cleaner, Engine (Engine Air Cleaner Filter) . . . 427
- Air Conditioner Maintenance . . . . . 431
- Air Conditioning . . . . . 284,285
- Air Conditioning Controls . . . . . 284,285
- Air Conditioning Filter . . . . . 297,432
- Air Conditioning, Operating Tips . . . . . 298
- Air Conditioning Refrigerant . . . . . 431,432
- Air Conditioning System . . . . . 284,285,289,431
- Air Pressure, Tires . . . . . 210,341
- Airbag . . . . . 49
- Airbag Deployment . . . . . 55,59
- Airbag Light . . . . . 56,61,76,216
- Airbag Maintenance . . . . . 61
- Airbag, Side . . . . . 50,56
- Airbag, Window (Side Curtain) . . . . . 50,56
- Alarm, Panic . . . . . 24
- Alarm (Security Alarm) . . . . . 18,206
- Alarm System (Security Alarm) . . . . . 18
- Alignment and Balance . . . . . 349
- All Wheel Drive (AWD) . . . . . 314
- Alterations/Modifications, Vehicle . . . . . 7
- Antenna, Satellite Radio . . . . . 268
- Antifreeze (Engine Coolant) . . . . . 439,440,468
- Disposal . . . . . 441
- Anti-Lock Brake System (ABS) . . . . . 322,323
- Anti-Lock Warning Light . . . . . 212,323,324
- Anti-Theft Security Alarm (Theft Alarm) . . . . . 18
- Anti-Theft System . . . . . 206
- Appearance Care . . . . . 449
- Arming Theft System (Security Alarm) . . . . . 18
- Assistance Towing . . . . . 102

Audio Systems (Radio) . . . . .	232,262	Auxiliary Electrical Outlet (Power Outlet) . . . . .	172
Auto Down Power Windows . . . . .	35	Auxiliary Power Outlet . . . . .	172
Auto Unlock, Doors . . . . .	30	Back-Up Lights . . . . .	464
Automatic Dimming Mirror . . . . .	85	Ball Joints . . . . .	435
Automatic Door Locks . . . . .	30	Battery . . . . .	429
Automatic Headlights . . . . .	145	Charging System Light . . . . .	210
Automatic Oil Change Indicator . . . . .	208,222	Emergency Starting . . . . .	404
Automatic Temperature Control (ATC) . . . . .	289	Gas Caution . . . . .	430
Automatic Transaxle . . . . .	306,447	Jump Starting . . . . .	404
Adding Fluid . . . . .	447,472	Keyless Transmitter Replacement (RKE) . . . . .	25
Filter . . . . .	449	Location . . . . .	405,429
Fluid and Filter Changes . . . . .	449	Bearings . . . . .	449
Fluid Level Check . . . . .	447	Belts, Drive . . . . .	426
Interlock System . . . . .	307,308	Belts, Seat . . . . .	40,76
Reset Mode . . . . .	311	Beverage Cooler . . . . .	178
Selection Of Lubricant . . . . .	472	Body Mechanism Lubrication . . . . .	435
Shifting . . . . .	306	B-Pillar Location . . . . .	336
Special Additives . . . . .	449	Brake Assist System . . . . .	325
Autostick . . . . .	312		

Brake Assist Warning Light . . . . .	214	Camera, Rear . . . . .	88
Brake Control System, Electronic . . . . .	323	Capacities, Fluid . . . . .	468
Brake Fluid . . . . .	472	Caps, Filler	
Brake, Parking . . . . .	318	Fuel . . . . .	367
Brake System . . . . .	321,444	Oil (Engine) . . . . .	416,417,418,425
Anti-Lock (ABS) . . . . .	322,323	Radiator (Coolant Pressure) . . . . .	440
Fluid Check . . . . .	445,472	Car Washes . . . . .	450
Hoses . . . . .	444	Carbon Monoxide Warning . . . . .	75,367
Master Cylinder . . . . .	445	Cargo Area Cover . . . . .	189
Parking . . . . .	318	Cargo Area Features . . . . .	186
Warning Light . . . . .	214	Cargo Compartment . . . . .	186
Brakes . . . . .	321,444	Light . . . . .	150,186
Brake/Transaxle Interlock . . . . .	307	Luggage Carrier . . . . .	194
Break-In Recommendations, New Vehicle . . . . .	74	Cargo Light . . . . .	150
Brightness, Interior Lights . . . . .	150	Cargo Load Floor . . . . .	186
Bulb Replacement . . . . .	460,462	Cargo Management System . . . . .	186
Bulbs, Light . . . . .	77,460	Rollaway Tonneau Cover . . . . .	189
		Tri-Fold Load Floor . . . . .	186
Calibration, Compass . . . . .	216,226	Cargo Tie-Downs . . . . .	187

- Cargo (Vehicle Loading) . . . . . 186,370
- Catalytic Converter . . . . . 427
- CD (Compact Disc) Player . . . . . 232,262
- CD (Compact Disc) Player Maintenance . . . . . 279
- Cellular Phone . . . . . 89,262,263
- Certification Label . . . . . 370
- Chains, Tire . . . . . 349
- Changing A Flat Tire . . . . . 392
- Charging System Light . . . . . 210
- Chart, Tire Sizing . . . . . 333
- Check Engine Light  
(Malfunction Indicator Light) . . . . . 420
- Checking Your Vehicle For Safety . . . . . 74
- Checks, Safety . . . . . 74
- Child Restraint . . . . . 64,65,66,69,71
- Child Restraint Tether Anchors . . . . . 68,69
- Child Safety Locks . . . . . 31
- Child Seat . . . . . 136
- Clean Air Gasoline . . . . . 364
- Cleaning
  - Wheels . . . . . 451
  - Windshield Wiper Blades . . . . . 435
- Climate Control . . . . . 280
- Clock . . . . . 233,236,252,263
- Coin Holder . . . . . 181
- Cold Weather Operation . . . . . 304
- Compact Disc (CD) Maintenance . . . . . 279
- Compact Spare Tire . . . . . 344
- Compass . . . . . 225
- Compass Calibration . . . . . 216,226
- Compass Variance . . . . . 216,226
- Computer, Trip/Travel . . . . . 223
- Connector
  - UCI . . . . . 273
  - Universal Consumer Interface (UCI) . . . . . 273
- Conserving Fuel . . . . . 223
- Console, Floor . . . . . 181
- Console, Overhead . . . . . 160

- Contract, Service . . . . . 489
- Converter, Catalytic . . . . . 427
- Coolant Pressure Cap (Radiator Cap) . . . . . 440
- Cooler, Beverage . . . . . 178
- Cooling System . . . . . 438
- Adding Coolant (Antifreeze) . . . . . 440
- Coolant Capacity . . . . . 468
- Coolant Level . . . . . 438,441
- Disposal of Used Coolant . . . . . 441
- Drain, Flush, and Refill . . . . . 439
- Inspection . . . . . 441
- Points to Remember . . . . . 442
- Pressure Cap . . . . . 440
- Radiator Cap . . . . . 440
- Selection of Coolant (Antifreeze) . . . . . 439,468,470
- Temperature Gauge . . . . . 203
- Corrosion Protection . . . . . 449
- Cruise Control (Speed Control) . . . . . 157
- Cruise Light . . . . . 210
- Cup Holder . . . . . 176,454
- Customer Assistance . . . . . 487
- Customer Programmable Features . . . . . 227
- Data Recorder, Event . . . . . 62
- Daytime Brightness, Interior Lights . . . . . 151
- Daytime Running Lights . . . . . 146
- Dealer Service . . . . . 422
- Defroster, Rear Window . . . . . 193
- Defroster, Windshield . . . . . 77,282,283
- Delay (Intermittent) Wipers . . . . . 153
- Diagnostic System, Onboard . . . . . 419
- Digital Video Disc (DVD) Player . . . . . 232,262
- Dimmer Control . . . . . 150
- Dimmer Switch, Headlight . . . . . 148
- Dipsticks
- Automatic Transaxle . . . . . 447
- Oil (Engine) . . . . . 422
- Disabled Vehicle Towing . . . . . 409

Disposal		
Antifreeze (Engine Coolant)	441	
Engine Oil	426	
Door Locks	28	
Door Locks, Automatic	30	
Door Opener, Garage	161	
Drive Belts	426	
Driving		
On Slippery Surfaces	315	
Through Flowing, Rising, or Shallow Standing Water	316	
DVD Player (Video Entertainment System)	272	
E-85 Fuel	359	
Electric Remote Mirrors	86	
Electrical Outlet, Auxiliary (Power Outlet)	172	
Electrical Power Outlets	172	
Electronic Brake Control System	323	
Anti-Lock Brake System	322	
Brake Assist System	325	
Electronic Roll Mitigation	326	
Electronic Stability Program	327	
Traction Control System	326	
Electronic Roll Mitigation (ERM)	326	
Electronic Speed Control (Cruise Control)	157	
Electronic Stability Program (ESP)	214,327	
Electronic Throttle Control Warning Light	209	
Electronic Vehicle Information Center (EVIC)	218	
Emergency, In Case of		
Freeing Vehicle When Stuck	408	
Hazard Warning Flasher	390	
Jacking	392	
Jump Starting	404	
Overheating	390	
Towing	409	
Emission Control System Maintenance	420,474	
Engine	74,416,417,418	
Air Cleaner	427	

- Block Heater . . . . . 306  
Break-In Recommendations . . . . . 74  
Checking Oil Level . . . . . 422  
Compartment . . . . . 416  
Coolant (Antifreeze) . . . . . 438,470  
Cooling . . . . . 438  
Exhaust Gas Caution . . . . . 38,75,367  
Fails to Start . . . . . 305  
Flooded, Starting . . . . . 305  
Fuel Requirements . . . . . 363  
Jump Starting . . . . . 404  
Oil . . . . . 422,468,470  
Oil Change Interval . . . . . 208,222,424  
Oil Filler Cap . . . . . 416,417,418,425  
Oil Filter . . . . . 426  
Oil Filter Disposal . . . . . 426  
Oil Selection . . . . . 424,468  
Oil Synthetic . . . . . 425  
Operation . . . . . 74  
Overheating . . . . . 390  
Starting . . . . . 303  
Temperature Gauge . . . . . 203  
Engine Oil Viscosity . . . . . 425  
Enhanced Accident Response Feature . . . . . 60  
Entry System, Illuminated . . . . . 20  
Ethanol . . . . . 364  
Event Data Recorder . . . . . 62  
Exhaust Gas Caution . . . . . 38,75,367,437  
Exhaust System . . . . . 75,437  
Exterior Folding Mirrors . . . . . 86  
Exterior Light Service . . . . . 462  
Exterior Lights . . . . . 77,462  
Fabric Care . . . . . 452,453  
Filler Location Fuel . . . . . 367  
Filters  
    Air Cleaner . . . . . 427  
    Air Conditioning . . . . . 297,432



Automatic Transaxle . . . . .	449	Fluid Level Checks	
Engine Oil . . . . .	426,470	Automatic Transaxle . . . . .	447
Engine Oil Disposal . . . . .	426	Brake . . . . .	445,472
Flashers		Cooling System . . . . .	438
Hazard Warning . . . . .	390	Engine Oil . . . . .	422
Turn Signal . . . . .	77,147,205	Power Steering . . . . .	434,472
Flash-To-Pass . . . . .	149	Fluids . . . . .	470
Flexible Fuel Vehicles . . . . .	359	Fluids, Lubricants and Genuine Parts . . . . .	470
Cruising Range . . . . .	362	Fog Light Service . . . . .	463
Engine Oil . . . . .	361	Fog Lights . . . . .	144,146,205,463
Fuel Requirements . . . . .	359,360	Folding Front Passenger Seat . . . . .	124
Maintenance . . . . .	359,362	Folding Rear Seat . . . . .	140,130
Replacement Parts . . . . .	362	Freeing A Stuck Vehicle . . . . .	408
Starting . . . . .	362	Front Wheel Bearings . . . . .	449
Flooded Engine Starting . . . . .	305	Fuel . . . . .	363
Floor Console . . . . .	181	Adding . . . . .	367
Fluid, Brake . . . . .	472	Additives . . . . .	366
Fluid Capacities . . . . .	468	Clean Air . . . . .	364
Fluid Leaks . . . . .	77	Conserving . . . . .	223

Ethanol . . . . .	364	Gas Gauge (Fuel Gauge) . . . . .	203
Filler Cap (Gas Cap) . . . . .	367	Gasoline, Clean Air . . . . .	364
Gasoline . . . . .	363	Gasoline (Fuel) . . . . .	363
Gauge . . . . .	203	Conserving . . . . .	223
Hoses . . . . .	444	Gasoline, Reformulated . . . . .	364
Materials Added . . . . .	366	Gauges	
Methanol . . . . .	364	Coolant Temperature . . . . .	203
Octane Rating . . . . .	363,470	Fuel . . . . .	203
Requirements . . . . .	363	Odometer . . . . .	207
Saver Mode . . . . .	223	Speedometer . . . . .	205
Specifications . . . . .	470	Tachometer . . . . .	206
Tank Capacity . . . . .	468	Gear Ranges . . . . .	309
Fuel, Flexible . . . . .	<i>See Flexible Fuel Vehicles</i>	Gearshift . . . . .	309
Fuel System Caution . . . . .	368	General Information . . . . .	18,26,116,313,358
Fueling . . . . .	367	General Maintenance . . . . .	422
Fuses . . . . .	455	Glass Cleaning . . . . .	454
		Gross Axle Weight Rating . . . . .	370,373
Garage Door Opener (HomeLink®) . . . . .	161	Gross Vehicle Weight Rating . . . . .	370,372
Gas Cap (Fuel Filler Cap) . . . . .	367,419	GVWR . . . . .	370

Hands-Free Phone (UConnect™) . . . . .	89,262,263	Time Delay . . . . .	145
Hard Drive (HDD) . . . . .	232,262	Heated Mirrors . . . . .	87
Hazard		Heated Seats . . . . .	129
Driving Through Flowing, Rising, or Shallow		Heater . . . . .	284,285
Standing Water . . . . .	316	Heater, Engine Block . . . . .	306
Hazard Warning Flasher . . . . .	390	High Beam Indicator . . . . .	205
Head Restraints . . . . .	127	High Beam/Low Beam Select (Dimmer) Switch . .	148
Head Rests . . . . .	127	Hitches	
Headlights . . . . .	144	Trailer Towing . . . . .	376
Automatic . . . . .	145	Holder, Coin . . . . .	181
Bulb Replacement . . . . .	462	Holder, Cup . . . . .	176
Cleaning . . . . .	453	HomeLink® (Garage Door Opener) Transmitter . . .	161
Delay . . . . .	145	Hood Release . . . . .	142
High Beam . . . . .	462	Hoses . . . . .	443,444
High Beam/Low Beam Select Switch . . . . .	148	Ignition . . . . .	14
Lights On Reminder . . . . .	146	Key . . . . .	12,14
On With Wipers . . . . .	145,154	Ignition Key Removal . . . . .	14
Passing . . . . .	149	Illuminated Entry . . . . .	20
Switch . . . . .	144		

- Immobilizer (Sentry Key) . . . . . 15
- Indicator, Traction Control . . . . . 213
- Infant Restraint . . . . . 64,65
- Inflation Pressure Tires . . . . . 210
- Information Center, Vehicle . . . . . 218
- Inside Rearview Mirror . . . . . 84
- Instrument Cluster . . . . . 202,203
- Instrument Panel and Controls . . . . . 201
- Instrument Panel Cover . . . . . 452
- Instrument Panel Lens Cleaning . . . . . 454
- Integrated Child Seat . . . . . 136
- Integrated Power Module (Fuses) . . . . . 455
- Interior Appearance Care . . . . . 452
- Interior Lighting . . . . . 144,149
- Interior Lights . . . . . 150
- Intermittent Wipers (Delay Wipers) . . . . . 153
- Introduction . . . . . 4
- Inverter, Power . . . . . 174
- Jack Location . . . . . 393
- Jack Operation . . . . . 392,398
- Jacking Instructions . . . . . 398
- Jump Starting . . . . . 404
- Key, Programming . . . . . 17
- Key, Replacement . . . . . 16
- Key, Sentry (Immobilizer) . . . . . 15
- Key-In Reminder . . . . . 15
- Keyless Entry System . . . . . 20
- Keys . . . . . 12
- Knee Bolster . . . . . 49
- Lane Change and Turn Signals . . . . . 147
- Lap/Shoulder Belts . . . . . 40
- LATCH (Lower Anchors and Tether for  
CHildren) . . . . . 68,69
- Latch Plate . . . . . 41

Latches . . . . .	77	Cargo . . . . .	150
Hood . . . . .	142	Courtesy/Reading . . . . .	149
Lead Free Gasoline . . . . .	363	Cruise . . . . .	210
Leaks, Fluid . . . . .	77	Daytime Running . . . . .	146
Life of Tires . . . . .	347	Dimmer Switch, Headlight . . . . .	144,148
Liftgate . . . . .	37	Electronic Stability Program (ESP)	
Liftgate Window Wiper/Washer . . . . .	191	Indicator . . . . .	214,327,329
Light Bulbs . . . . .	77,460	Electronic Throttle Control Warning . . . . .	209
Light Replacement . . . . .	462	Exterior . . . . .	77
Lights . . . . .	77,144,462	Fog . . . . .	146,205,463
Airbag . . . . .	56,61,76,216	Hazard Warning Flasher . . . . .	390
Anti-Lock . . . . .	324	Headlight Switch . . . . .	144
Anti-Lock Warning . . . . .	212	Headlights . . . . .	144,462
Automatic Headlights . . . . .	145	Headlights On Reminder . . . . .	146
Back-Up . . . . .	464	Headlights On With Wipers . . . . .	145,154
Battery Saver . . . . .	150	High Beam . . . . .	148,205,462
Brake Assist Warning . . . . .	214,329	High Beam Indicator . . . . .	205
Brake Warning . . . . .	214	High Beam/Low Beam Select . . . . .	148
Bulb Replacement . . . . .	462	Illuminated Entry . . . . .	20

Instrument Cluster . . . . .	144,203	Tire Pressure Monitoring (TPMS) . . . . .	210,350
Intensity Control . . . . .	150	Traction Control . . . . .	213,327,329
Interior . . . . .	149,150	Turn Signal . . . . .	77,144,147,205,462,464
License . . . . .	467	Vanity Mirror . . . . .	87
Lights On Reminder . . . . .	146	Warning (Instrument Cluster Description) . . . . .	203
Low Fuel . . . . .	203,205	Load Floor, Cargo . . . . .	186
Low Tire . . . . .	210	Loading Vehicle . . . . .	370,371
Malfunction Indicator (Check Engine) . . . . .	213	Capacities . . . . .	371
Map Reading . . . . .	149	Tires . . . . .	336
Oil Pressure . . . . .	209	Locks . . . . .	28
Parade Mode (Daytime Brightness) . . . . .	151	Auto Unlock . . . . .	30
Park . . . . .	144,462	Automatic Door . . . . .	30
Passing . . . . .	149	Child Protection . . . . .	31
Rear Servicing . . . . .	462,464	Door . . . . .	28
Rear Tail . . . . .	464	Power Door . . . . .	29
Seat Belt Reminder . . . . .	206	Low Tire Pressure System . . . . .	350
Service . . . . .	460,462	Lower Anchors and Tether for Children (LATCH) . . . . .	68,69
Service Engine Soon (Malfunction Indicator) . . . . .	213	Lubrication, Body . . . . .	435
Side Marker . . . . .	462		

- Luggage Rack (Roof Rack) . . . . . 194
- Lumbar Support . . . . . 123
- Maintenance Free Battery . . . . . 429
- Maintenance, General . . . . . 422
- Maintenance Procedures . . . . . 422
- Maintenance Schedule . . . . . 474
- Maintenance, Sunroof . . . . . 171
- Malfunction Indicator Light (Check Engine) . . 213,420
- Manual, Service . . . . . 492
- Map/Reading Lights . . . . . 149
- Marker Lights, Side . . . . . 462
- Master Cylinder (Brakes) . . . . . 445
- Methanol . . . . . 364
- Mini-Trip Computer . . . . . 223
- Mirrors . . . . . 84,161
  - Automatic Dimming . . . . . 85
  - Electric Powered . . . . . 86
  - Electric Remote . . . . . 86
- Exterior Folding . . . . . 86
  - Heated . . . . . 87
  - Outside . . . . . 85
  - Rearview . . . . . 84
  - Vanity . . . . . 87
- Mode
  - Fuel Saver . . . . . 223
- Modifications/Alterations, Vehicle . . . . . 7
- Monitor, Tire Pressure System . . . . . 350
- Mopar Parts . . . . . 421,491
- MP3 Player . . . . . 232,262
- MTBE/ETBE . . . . . 364
- Multi-Function Control Lever . . . . . 144
- Navigation Radio . . . . . 262
- Navigation System . . . . . 262
- New Vehicle Break-In Period . . . . . 74
- Occupant Restraints . . . . . 38

Octane Rating, Gasoline (Fuel) . . . . .	363,470	Oil Filter, Selection . . . . .	426
Odometer		Onboard Diagnostic System . . . . .	419,420
Trip . . . . .	210,216	Opener, Garage Door (HomeLink®) . . . . .	161
Oil Change Indicator . . . . .	208,222	Operating Precautions . . . . .	419
Oil Change Indicator, Reset . . . . .	208,222	Outside Rearview Mirrors . . . . .	85
Oil, Engine . . . . .	422,470	Overdrive . . . . .	206,310
Capacity . . . . .	468	Overhead Console . . . . .	160
Change Interval . . . . .	208,222,424	Overheating, Engine . . . . .	204,390,391
Checking . . . . .	422	Owner's Manual (Operator Manual) . . . . .	492
Dipstick . . . . .	422		
Disposal . . . . .	426	Paint Care . . . . .	449
Filter . . . . .	426,470	Panic Alarm . . . . .	24
Filter Disposal . . . . .	426	Parking Brake . . . . .	318
Identification Logo . . . . .	424	Parking On Hill . . . . .	319
Materials Added to . . . . .	425	Passenger Seat Back Tilt (Easy Entry System) . . . . .	137
Recommendation . . . . .	424,468	Passing Light . . . . .	149
Synthetic . . . . .	425	Personal Settings . . . . .	227
Viscosity . . . . .	425,468	Pets . . . . .	73
Oil Filter, Change . . . . .	426	Phone, Cellular . . . . .	89,262,263



- Phone, Hands-Free (UConnect™) . . . . . 89,262,263
- Placard, Tire and Loading Information . . . . . 336
- Port
  - Universal Serial Bus (USB) . . . . . 232,262
  - USB . . . . . 232,262
- Power
  - Brakes . . . . . 321
  - Distribution Center (Fuses) . . . . . 455
  - Door Locks . . . . . 29
  - Inverter . . . . . 174
  - Mirrors . . . . . 86
  - Outlet (Auxiliary Electrical Outlet) . . . . . 172
  - Seats . . . . . 126
  - Steering . . . . . 331
  - Steering, Checking . . . . . 434
  - Sunroof . . . . . 168
  - Windows . . . . . 34
- Power Steering Fluid . . . . . 434,472
- Power Transfer Unit . . . . . 472
- Pregnant Women and Seat Belts . . . . . 48
- Preparation for Jacking . . . . . 393
- Pretensioners
  - Seat Belts . . . . . 46
- Programmable Electronic Features . . . . . 227
- Programming Transmitters  
(Remote Keyless Entry) . . . . . 20
- Radial Ply Tires . . . . . 344
- Radiator Cap (Coolant Pressure Cap) . . . . . 440
- Radio Broadcast Signals . . . . . 230
- Radio, Navigation . . . . . 262
- Radio Operation . . . . . 232,263,280
- Radio Remote Controls . . . . . 278
- Radio, Satellite . . . . . 232,262,263,267
- Radio (Sound Systems) . . . . . 232,262
- Rear Camera . . . . . 88
- Rear Cup Holder . . . . . 176
- Rear Liftgate . . . . . 37

Rear Seat, Folding	130,140	Remote Keyless Entry (RKE)	20
Rear Washer Fluid	192	Remote Sound System (Radio) Controls	278
Rear Wheel Bearings	449	Remote Starting System	26
Rear Window Defroster	193	Replacement Bulbs	460
Rear Window Features	191	Replacement Keys	16
Rear Wiper/Washer	191	Replacement Parts	421
Rearview Mirrors	84	Replacement Tires	347
Reception, Radio	230	Reporting Safety Defects	491
Reclining Front Seats	122	Resetting Oil Change Indicator	208,222
Reclining Rear Seats	134,140	Restraint, Head	127
Recorder, Event Data	62	Restraints, Child	64
Recreational Towing	387	Restraints, Occupant	38
Reformulated Gasoline	364	Retractable Cargo Area Cover	189
Refrigerant	432	Reverse Lights	464
Release, Hood	142	Rocking Vehicle When Stuck	408
Reminder, Lights On	146	Roof Rack (Luggage Rack)	194
Reminder, Seat Belt	46		
Remote Control		Safety Checks Inside Vehicle	76
Starting System	26	Safety Checks Outside Vehicle	77

Safety Defects, Reporting . . . . .	491	Reminder . . . . .	206
Safety, Exhaust Gas . . . . .	38,75	Untwisting Procedure . . . . .	45
Safety Information, Tire . . . . .	332	Seats . . . . .	121
Safety Tips . . . . .	74	Adjustment . . . . .	121
Satellite Radio . . . . .	232,262,263,267	Child . . . . .	136
Satellite Radio Antenna . . . . .	268	Cleaning . . . . .	453
Schedule, Maintenance . . . . .	474	Easy Entry . . . . .	137
Seat Belt Maintenance . . . . .	454	Head Restraints . . . . .	127
Seat Belt Reminder . . . . .	46	Heated . . . . .	129
Seat Belts . . . . .	38,40,76	Height Adjustment . . . . .	124,126
Adjustable Upper Shoulder Anchorage . . . . .	44	Integrated, Child . . . . .	136
And Pregnant Women . . . . .	48	Lumbar Support . . . . .	123
Child Restraint . . . . .	64,65,66,71	Power . . . . .	126
Extender . . . . .	48	Rear Folding . . . . .	130,140
Front Seat . . . . .	40,41	Reclining . . . . .	122
Inspection . . . . .	76	Reclining Rear . . . . .	134,140
Operating Instructions . . . . .	41	Seatback Release . . . . .	124,130,140
Pretensioners . . . . .	46	Tilting . . . . .	126
Rear Seat . . . . .	40	Security Alarm (Theft Alarm) . . . . .	18,206

- Selection of Coolant (Antifreeze) . . . . . 439,470
- Selection of Oil . . . . . 424
- Sentry Key (Immobilizer) . . . . . 15
- Sentry Key Programming . . . . . 17
- Sentry Key Replacement . . . . . 16
- Service Assistance . . . . . 487
- Service Contract . . . . . 489
- Service Engine Soon Light  
(Malfunction Indicator) . . . . . 213
- Service Manuals . . . . . 492
- Setting the Clock . . . . . 233,236,252,263
- Settings, Personal . . . . . 227
- Shifting
  - Automatic Transaxle . . . . . 306
- Shoulder Belt Upper Anchorage . . . . . 44
- Shoulder Belts . . . . . 40
- Side Airbag . . . . . 50,56
- Side Curtain (Window Airbag) . . . . . 50
- Side View Mirror Adjustment . . . . . 85
- Side Window Demisters (Defrosters) . . . . . 297
- Signals, Turn . . . . . 77,147,205,464
- Slippery Surfaces, Driving On . . . . . 315
- Snow Chains (Tire Chains) . . . . . 349
- Snow Tires . . . . . 350
- Sound Systems (Radio) . . . . . 232,262
- Spare Tire . . . . . 344,345,393
- Spark Plugs . . . . . 427,470
- Specifications
  - Fuel (Gasoline) . . . . . 470
  - Oil . . . . . 424,470
- Speed Control (Cruise Control) . . . . . 157
- Speedometer . . . . . 205
- Starting . . . . . 26,303
  - Automatic Transmission . . . . . 304
  - Cold Weather . . . . . 304
  - Emergency (Jump Starting) . . . . . 404
  - Engine Fails to Start . . . . . 305
  - Remote . . . . . 26

Starting and Operating . . . . .	303	Sway Control, Trailer . . . . .	330,374
Starting Procedures . . . . .	303	Synthetic Engine Oil . . . . .	425
Steering		System, Navigation . . . . .	262
Column Lock . . . . .	156	System, Remote Starting . . . . .	26
Linkage . . . . .	435	Tachometer . . . . .	206
Power . . . . .	331,434	Taillights . . . . .	464
Tilt Column . . . . .	156	Telescoping Steering Column . . . . .	156
Wheel, Tilt . . . . .	156	Temperature Control, Automatic (ATC) . . . . .	289
Steering Wheel Mounted Sound		Temperature Gauge, Engine Coolant . . . . .	203
System Controls . . . . .	278	Tether Anchor, Child Restraint . . . . .	68
Storage . . . . .	178,460	Theft Alarm (Security Alarm) . . . . .	18
Storage Bin . . . . .	178	Theft System (Security Alarm) . . . . .	18
Storage, Vehicle . . . . .	296	Tie Down Hooks, Cargo . . . . .	187
Stuck, Freeing . . . . .	408	Tilt Steering Column . . . . .	156
Sun Roof . . . . .	168	Time Delay, Headlight . . . . .	145
Sun Visor Extension . . . . .	87	Tip Start . . . . .	14
Sunglasses Storage . . . . .	161	Tire and Loading Information Placard . . . . .	336
Sunroof Maintenance . . . . .	171	Tire Identification Number (TIN) . . . . .	335
Supplemental Restraint System - Airbag . . . . .	49		

Tire Markings . . . . .	332	Safety . . . . .	332,340
Tire Safety Information . . . . .	332	Sizes . . . . .	333
Tires . . . . .	77,340,493	Snow Tires . . . . .	350
Aging (Life of Tires) . . . . .	347	Spare Tire . . . . .	393
Air Pressure . . . . .	340	Spinning . . . . .	346
Alignment . . . . .	349	Trailer Towing . . . . .	382
Chains . . . . .	349	Tread Wear Indicators . . . . .	346
Changing . . . . .	392	To Open Hood . . . . .	142
Compact Spare . . . . .	344	Tongue Weight/Trailer Weight . . . . .	379
General Information . . . . .	340	Towing . . . . .	372
High Speed . . . . .	343	24-Hour Towing Assistance . . . . .	102
Inflation Pressures . . . . .	341	Behind a Motor Home . . . . .	387
Jacking . . . . .	392	Disabled Vehicle . . . . .	409
Life of Tires . . . . .	347	Guide . . . . .	377
Load Capacity . . . . .	336,337	Recreational . . . . .	387
Pressure Monitor System (TPMS) . . . . .	350	Weight . . . . .	377
Quality Grading . . . . .	493	Towing Assistance . . . . .	102
Radial . . . . .	344	Towing Vehicle Behind a Motor Home . . . . .	387
Replacement . . . . .	347	Traction . . . . .	315

- Traction Control . . . . . 213,326
- Trailer Sway Control (TSC) . . . . . 330
- Trailer Towing . . . . . 372
  - Cooling System Tips . . . . . 387
  - Hitches . . . . . 376
  - Minimum Requirements . . . . . 380
  - Tips . . . . . 385
  - Trailer and Tongue Weight . . . . . 379
  - Wiring . . . . . 383
- Trailer Towing Guide . . . . . 377
- Trailer Weight . . . . . 377
- Transaxle
  - Additives . . . . . 449
  - Automatic . . . . . 306,447
  - Autostick . . . . . 312
  - Filter . . . . . 449
  - Maintenance . . . . . 447
  - Operation . . . . . 306
  - Overdrive . . . . . 310
  - Selection of Lubricant . . . . . 472
- Transmission . . . . . *See Transaxle*
- Transmitter Battery Service  
(Remote Keyless Entry) . . . . . 25
- Transmitter, Garage Door Opener  
(HomeLink®) . . . . . 161
- Transmitter Programming  
(Remote Keyless Entry) . . . . . 20
- Transmitter, Remote Keyless Entry (RKE) . . . . . 20
- Transporting Pets . . . . . 73
- Tread Wear Indicators . . . . . 346
- Trip Odometer . . . . . 207
- Trip Odometer Reset Button . . . . . 210,216
- Turn Signals . . . . . 144,147,205,464
- UCI Connector . . . . . 273
- UConnect™ (Hands-Free Phone) . . . . . 89,262
- Uniform Tire Quality Grades . . . . . 493
- Universal Consumer Interface (UCI) Connector . . . 273

- Universal Serial Bus (USB) Port . . . . . 232,262
- Universal Transmitter . . . . . 161
- Unleaded Gasoline . . . . . 363
- Untwisting Procedure, Seat Belt . . . . . 45
- Upholstery Care . . . . . 452
- USB Port . . . . . 232,262
- 
- Vacuum/Vapor Harnesses . . . . . 443
- Vanity Mirrors . . . . . 87
- Variance, Compass . . . . . 216,226
- Vehicle Certification Label . . . . . 370
- Vehicle Identification Number (VIN) . . . . . 6
- Vehicle Loading . . . . . 337,370,371
- Vehicle Modifications/Alterations . . . . . 7
- Vehicle Storage . . . . . 296,460
- Vehicle Theft Alarm (Security Alarm) . . . . . 18
- Video Entertainment System  
(Rear Seat Video System) . . . . . 272
- Viscosity, Engine Oil . . . . . 425
- 
- Voice Recognition System (VR) . . . . . 116
- 
- Warning Flasher, Hazard . . . . . 390
- Warning Lights (Instrument Cluster  
Description) . . . . . 203
- Warnings and Cautions . . . . . 6
- Warranty Information . . . . . 490
- Washer, Adding Fluid . . . . . 155,192,436
- Washers, Windshield . . . . . 151,154,436
- Washing Vehicle . . . . . 450
- Water  
    Driving Through . . . . . 316
- Wheel Alignment and Balance . . . . . 349
- Wheel and Wheel Trim . . . . . 451
- Wheel and Wheel Trim Care . . . . . 451
- Wheel Bearings . . . . . 449
- Wheel Nut Torque . . . . . 403
- Wind Buffeting . . . . . 37,171
- Window Airbag (Side Curtain) . . . . . 50,56



Window Fogging . . . . .	296	Wiper Blade Replacement . . . . .	435,436
Windows . . . . .	34	Wiper, Delay . . . . .	153
Power . . . . .	34	Wiper, Rear . . . . .	191
Windshield Defroster . . . . .	77,282,283	Wipers, Intermittent . . . . .	153
Windshield Washers . . . . .	151,154	Wrecker Towing . . . . .	409
Fluid . . . . .	436		
Windshield Wiper Blades . . . . .	435	YES Essentials® Fabric Cleaning Procedure . . . . .	453
Windshield Wipers . . . . .	151		

## **INSTALLATION OF RADIO TRANSMITTING EQUIPMENT**

Special design considerations are incorporated into this vehicle's electronic system to provide immunity to radio frequency signals. Mobile two-way radios and telephone equipment must be installed properly by trained personnel. The following must be observed during installation.

The positive power connection should be made directly to the battery and fused as close to the battery as possible. The negative power connection should be made to body sheet metal adjacent to the negative battery connection. This connection should not be fused.

Antennas for two-way radios should be mounted on the roof or the rear area of the vehicle. Care should be used in mounting antennas with magnet bases. Magnets may affect the accuracy or operation of the compass on vehicles so equipped.

The antenna cable should be as short as practical and routed away from the vehicle wiring when possible. Use only fully shielded coaxial cable.

Carefully match the antenna and cable to the radio to ensure a low Standing Wave Ratio (SWR).

Mobile radio equipment with output power greater than normal may require special precautions.

All installations should be checked for possible interference between the communications equipment and the vehicle's electronic systems.



STICK WITH THE SPECIALISTS®

Chrysler LLC  
81-226-0910

