

**DODGE**



***AVENGER***  
USER GUIDE **2010**



**IMPORTANT:** This User Guide is intended to familiarize you with the important features of your vehicle. The DVD enclosed contains your Owner's Manual, Navigation/Media Center Manuals, Warranty Booklets, Tire Warranty and 24-Hour Towing Assistance (new vehicles purchased in the U.S.) or Roadside Assistance (new vehicles purchased in Canada) in electronic format. We hope you find it useful. If you are the first registered owner of your vehicle, you may obtain a printed copy of the Owner's Manual, Navigation/Media Center Manuals or Warranty Booklet by calling 1-800-423-6343 (U.S.) or 1-800-387-1143 (Canada) or by contacting your dealer. Replacement DVD kits may be purchased by visiting [www.techauthority.com](http://www.techauthority.com).  
Copyright © 2010 Chrysler Group LLC.

# TABLE OF CONTENTS

## INTRODUCTION/WELCOME

WELCOME FROM CHRYSLER GROUP LLC . . . . .	2
---	---

## CONTROLS AT A GLANCE

DRIVER COCKPIT . . . . .	4
INSTRUMENT CLUSTER . . . . .	6

## GETTING STARTED

KEY FOB . . . . .	8
THEFT ALARM . . . . .	9
SEAT BELT . . . . .	9
CHILD RESTRAINTS . . . . .	9
FRONT SEATS . . . . .	11
REAR SEATS . . . . .	14
HEATED SEATS . . . . .	14
TILT / TELESCOPING STEERING COLUMN . . . . .	15
PROGRAMMABLE FEATURES . . . . .	15

## OPERATING YOUR VEHICLE

TURN SIGNAL/LIGHTS LEVER . . . . .	17
WIPER/WASHER LEVER . . . . .	18
SPEED CONTROL LEVER . . . . .	18
MANUAL CLIMATE CONTROLS . . . . .	20
AUTOMATIC TEMPERATURE CONTROLS (ATC) . . . . .	20
POWER SUNROOF . . . . .	21
WIND BUFFETING . . . . .	22

## ELECTRONICS

NON-TOUCH-SCREEN RADIOS . . . . .	23
TOUCH-SCREEN RADIOS . . . . .	26
REMOTE AUDIO CONTROLS . . . . .	31
ELECTRONIC VEHICLE INFORMATION CENTER (EVIC) . . . . .	31
UNIVERSAL GARAGE DOOR OPENER (HOMELINK <sup>®</sup> ) . . . . .	32
POWER OUTLET . . . . .	33
Uconnect <sup>™</sup> Phone . . . . .	33
VOICE COMMAND . . . . .	35

## UTILITY

TRAILER TOWING WEIGHTS (MAXIMUM TRAILER WEIGHT RATINGS) . . . . .	37
--	----

RECREATIONAL TOWING (BEHIND MOTORHOME, ETC.) . . . . .	38
BRAKE/TRANSAXLE INTERLOCK MANUAL OVERRIDE . . . . .	38

## WHAT TO DO IN EMERGENCIES

24-HOUR TOWING ASSISTANCE - U.S. ONLY . . . . .	39
INSTRUMENT CLUSTER WARNING LIGHTS . . . . .	39
IF YOUR ENGINE OVERHEATS . . . . .	42
JACKING AND TIRE CHANGING . . . . .	43
JUMP-STARTING . . . . .	47
TOWING A DISABLED VEHICLE . . . . .	51
FREEDING A STUCK VEHICLE . . . . .	52
EVENT DATA RECORDER (EDR) . . . . .	53

## MAINTAINING YOUR VEHICLE

OPENING THE HOOD . . . . .	54
ENGINE COMPARTMENT . . . . .	55
FLUIDS AND CAPACITIES . . . . .	58
MAINTENANCE CHART . . . . .	60
FUSES . . . . .	62
TIRE PRESSURES . . . . .	64
WHEEL AND WHEEL TRIM CARE . . . . .	64
EXTERIOR BULBS . . . . .	65

## CONSUMER ASSISTANCE

CHRYSLER GROUP LLC CUSTOMER CENTER . . . . .	66
CHRYSLER CANADA INC. CUSTOMER CENTER . . . . .	66
ASSISTANCE FOR THE HEARING IMPAIRED . . . . .	66
PUBLICATIONS ORDERING . . . . .	66
REPORTING SAFETY DEFECTS IN THE 50 UNITED STATES AND WASHINGTON, D.C. . . . .	67
TIRE WARRANTY . . . . .	67

## MOPAR ACCESSORIES

MOPAR <sup>®</sup> ACCESSORIES . . . . .	70
--	----



# INTRODUCTION/WELCOME

## WELCOME FROM CHRYSLER GROUP LLC

Congratulations on selecting your new Chrysler Group LLC vehicle. Be assured that it represents precision workmanship, distinctive styling, and high quality - all essentials that are traditional to our vehicles.

This guide illustrates and describes the operation of features and equipment that are either standard or optional on this vehicle. This guide may also include a description of features and equipment that are no longer available or were not ordered on this vehicle. Please disregard any features and equipment described in this guide that are not available on this vehicle. Chrysler Group LLC reserves the right to make changes in design and specifications and/or make additions to or improvements to its products without imposing any obligation upon itself to install them on products previously manufactured.

For complete owner information, refer to the DVD in the owner's kit provided at the time of new vehicle purchase. For your convenience, the information contained on the DVD may also be printed and saved for future reference.

Chrysler Group LLC is committed to protecting our environment and natural resources. By converting from paper to electronic delivery for the majority of the user information for your vehicle, together we greatly reduce the demand for tree-based products and lessen the stress on our environment.

### Vehicles Sold In Canada

With respect to any Vehicles sold in Canada, the name Chrysler Group LLC shall be deemed to be deleted and the name Chrysler Canada Inc. used in substitution therefore.

### Driving And Alcohol

Drunken driving is one of the most frequent causes of accidents.

Your driving ability can be seriously impaired with blood alcohol levels far below the legal minimum. If you are drinking, don't drive. Ride with a designated non-drinking driver, call a cab, a friend, or use public transportation.

### WARNING!

Driving after drinking can lead to an accident. Your perceptions are less sharp, your reflexes are slower, and your judgment is impaired when you have been drinking. Never drink and then drive.



# INTRODUCTION/WELCOME

## CAUTION!

Never park your vehicle over dry grass or other combustible materials. The heat from your vehicle exhaust system could cause a fire.

CHRYSLER, DODGE, JEEP, ATF+4, MOPAR and Uconnect are registered trademarks of Chrysler Group LLC.

**COPYRIGHT ©2010 CHRYSLER GROUP LLC**



# CONTROLS AT A GLANCE

## DRIVER COCKPIT





# CONTROLS AT A GLANCE



Audio System (non-touch-screen radio shown)

Climate Controls

SWITCH PANEL

Heated Seats\*

Electronic Vehicle Information Center (EVIC) Controls\*

Hazard Switch

Electronic Stability Control\*

Power Outlet

Transmission Gear Selector

Park Brake Lever





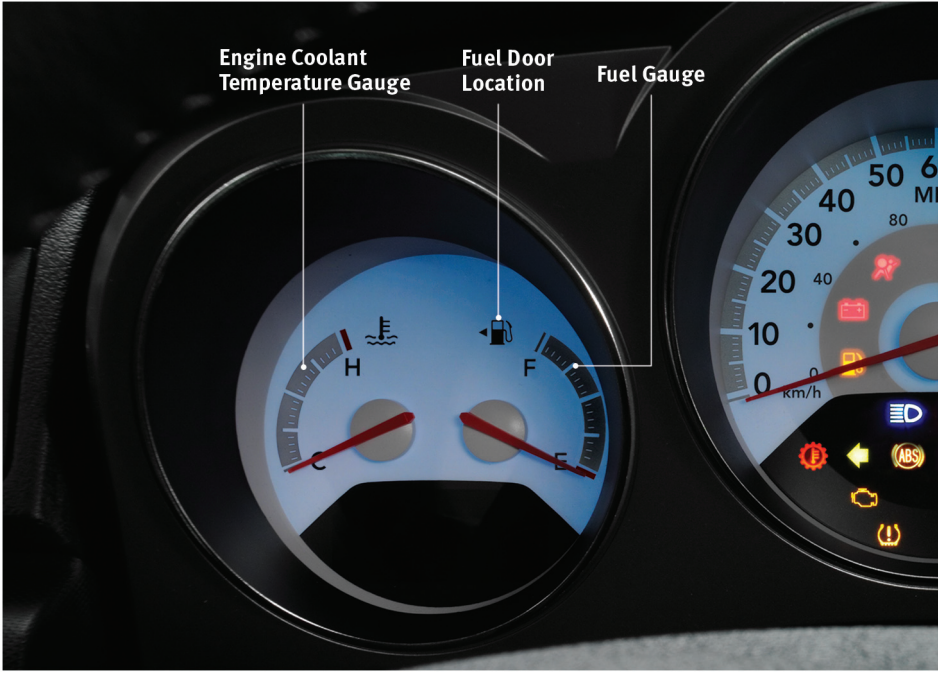





\*If Equipped

# CONTROLS AT A GLANCE





## INSTRUMENT CLUSTER

### Warning Lights

-  - Low Fuel Warning Light
-  - Charging System Light\*\*
-  - Oil Pressure Warning Light\*\*
-  - Anti-Lock Brake (ABS) Light\*\*
-  - Airbag Warning Light\*\*
-  - Electronic Throttle Control (ETC) Light
-  - Tire Pressure Monitoring System (TPMS) Light
-  - Engine Temperature Warning Light
-  - Transmission Temperature Warning Light
-  - Seat Belt Reminder Light

### **BRAKE**







-  - Brake Warning Light\*\*
-  - Malfunction Indicator Light (MIL)\*\*
-  - Electronic Stability Control (ESC) Activation/Malfunction Indicator Light\*\*



# CONTROLS AT A GLANCE



## Indicators

-  - Turn Signal Indicators
-  - High Beam Indicator
-  - Front Fog Light Indicator
-  - Position Light Indicator
-  - Vehicle Security Indicator\*
- CRUISE** - Cruise Indicator
-  - Electronic Stability Control (ESC) Off Indicator

## Odometer Messages

door - Door Ajar

deck - Trunk Ajar

HOTOIL\* - Transaxle Oil Temperature

Exceeds Safe Threshold

CHAngE OIL\* - Change Engine Oil

gASCAP - Fuel Cap Fault

LoW TirE\* - Low Tire Pressure

\* If equipped

\*\* Bulb Check with Key On



# GETTING STARTED

## KEY FOB



### Locking And Unlocking The Doors

- Press the LOCK button once to lock all the doors. Press the UNLOCK button once to unlock the driver's door only and twice within five seconds to unlock all the doors.
- All doors can be programmed to unlock on the first press of the UNLOCK button. Refer to Programmable Features in this guide.

## WARNING!

Leaving unattended children in a vehicle is dangerous for a number of reasons. A child or others could be injured. Children should be warned not to touch the parking brake, brake pedal, or the shift lever. Do not leave the key in the ignition. A child could operate power windows, other controls, or move the vehicle.

### Opening The Trunk

- Press the TRUNK button on the transmitter two times within five seconds to open the trunk.

### Remote Start

- Press the REMOTE START button  twice within five seconds. Pressing the REMOTE START button a third time shuts the engine off.
- To drive the vehicle, press the UNLOCK button, insert the key in the ignition and turn to the ON/RUN position.
- With remote start, the engine will only run for 15 minutes (timeout) unless the ignition key is placed in the ON/RUN position.
- The vehicle must be started with the key after two consecutive timeouts.

## WARNING!

- Do not start or run an engine in a closed garage or confined area. Exhaust gas contains Carbon Monoxide (CO) which is odorless and colorless. Carbon Monoxide is poisonous and can cause serious injury or death when inhaled.
- Keep Key Fob transmitters away from children. Operation of the Remote Start System, windows, door locks or other controls could cause serious injury or death.



# GETTING STARTED

## Panic Alarm

- Press the PANIC button once to turn the panic alarm on.
- Wait approximately three seconds and press the button a second time to turn the panic alarm off.

## THEFT ALARM

### To Arm

- Press the Key Fob LOCK button or the power door lock switch while the door is open.

### To Disarm

- Press the Key Fob UNLOCK button and turn the ignition to the ON/RUN position.

## SEAT BELT

- Be sure everyone in your vehicle is in a seat and using a seat belt properly.

### WARNING!

In a collision, you and your passengers can suffer much greater injuries if you are not properly buckled up. You can strike the interior of your vehicle or other passengers, or you can be thrown out of the vehicle. Always be sure you and others in your vehicle are buckled up properly.

## CHILD RESTRAINTS

- Children 12 years and under should ride properly buckled up in a rear seat, if available. According to crash statistics, children are safer when properly restrained in the rear seats rather than in the front.
- Every state in the United States and all Canadian provinces require that small children ride in proper restraint systems. This is the law, and you can be prosecuted for ignoring it.

### WARNING!

- In a collision, an unrestrained child, even a tiny baby, can become a projectile inside the vehicle. The force required to hold even an infant on your lap could become so great that you could not hold the child, no matter how strong you are. The child and others could be badly injured. Any child riding in your vehicle should be in a proper restraint for the child's size.
- Rearward-facing child seats must **NEVER** be used in the front seat of a vehicle with a front passenger airbag. An airbag deployment could cause severe injury or death to infants in this position.



# GETTING STARTED

## Installing The LATCH-Compatible Child Restraint System

- Your vehicle's second row passenger seats are equipped with the child restraint anchorage system called LATCH, which stands for Lower Anchors and Tether for CHildren.
- Child seats with fixed lower attachments must be installed in the outboard positions only. Child seats with flexible lower attachments can be used in all three seating positions.
- **Never** install LATCH-compatible child seats such that two seats share a common lower anchorage. If you are installing LATCH-compatible child restraints in adjacent rear seating positions, you can use either the lower anchors or the vehicle seat belt in the outboard seating position, but the center seating position must use the vehicle seat belt. Always use the top tether anchorage with a forward facing child seat.



- The rear seat lower anchorages are round bars, located at the rear of the seat cushion where it meets the seatback. They are just visible when you lean into the rear seat to install the child restraint. You will easily feel them if you run your finger along the intersection of the seatback and seat cushion surfaces.
- In addition, there are tether strap anchorages behind each rear seating position located in the panel between the rear seatback and the rear window. These tether strap anchorages are under a plastic cover.
- Loosen the adjusters on the lower straps and tether straps so that you can attach the hook or connector to the lower and tether anchorages more easily.
- Attach the lower hooks or connectors over the top of the seat cover material.
- Then rotate the tether anchorage cover directly behind the seat where you are placing the child restraint and attach the tether strap to the anchorage, being careful to route the tether strap to provide the most direct path between the anchor and the child restraint.
- Tighten all three straps as you push the child restraint rearward and downward into the seat.

### WARNING!

- Improper installation of a child restraint to the LATCH anchorages can lead to failure of an infant or child restraint. The child could be badly injured or killed. Follow the manufacturer's directions exactly when installing an infant or child restraint.
- An incorrectly anchored tether strap could lead to increased head motion and possible injury to the child. Use only the anchor positions directly behind the child seat to secure a child restraint top tether strap.



# GETTING STARTED

## Installing The Child Restraint Using The Vehicle Seat Belts

- To install a child restraint, first, pull enough of the seat belt webbing from the retractor to route it through the belt path of the child restraint and slide the latch plate into the buckle.
- Next, extract all the seat belt webbing out of the retractor and then allow the belt to retract into the retractor. Finally, pull on any excess webbing to tighten the lap portion around the child restraint. Any seat belt system will loosen with time, so check the belt occasionally, and pull it tight if necessary.
- Rotate the cover over the anchor directly behind the seat where you are placing the child restraint. These tether strap anchorages are under a plastic cover.
- Route the tether strap to provide the most direct path for the strap between the anchor and the child seat.
- Attach the tether strap hook of the child restraint to the anchor and remove slack in the tether strap according to the child restraint manufacturer's instructions.

## FRONT SEATS

### WARNING!

Adjusting a seat while the vehicle is moving is dangerous. The sudden movement of the seat could cause you to lose control. The seat belt might not be properly adjusted, and you could be injured. Only adjust a seat while the vehicle is parked.

## Manual Seat Adjustment

### Forward/Rearward



- Lift up on the adjusting bar located at the front of the seat near the floor and release at the desired position.



# GETTING STARTED

## Recliner



- Lift the recliner lever located on the outboard side of the seat, lean back and release at the desired position.

## WARNING!

Do not ride with the seatback reclined so that the seat belt is no longer resting against your chest. In a collision, you could slide under the seat belt and be seriously or even fatally injured. Use the recliner only when the vehicle is parked.

## Lumbar Support



- The lumbar adjust lever is on the outboard side of the seatback. Rotate the lumbar adjust lever downward to increase the lumbar support or upward to decrease the lumbar support as desired.



# GETTING STARTED

## Driver's Seat Height Adjustment

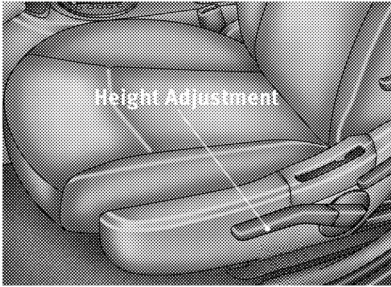

- The height adjustment control lever is located on the outboard side of the seat. Raise the lever to raise the seat. Lower the lever to lower the seat.

## Power Seat

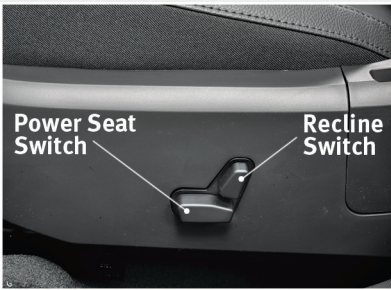

- The power seat switch, located on the outboard side of the seat near the floor, controls forward/back, up/down, and tilt adjustment.
- The recline switch controls the seatback recliner.

## CAUTION!

DO NOT place any article under a power seat or impede its ability to move as it may cause damage to the seat controls. Seat travel may become limited if movement is stopped by an obstruction in the seat's path.

## Fold-Flat Front Passenger Seat



- The front passenger seat can be folded flat. Pull up on the recliner lever to fold down the seat back.



# GETTING STARTED

## REAR SEATS

### Folding Rear Seatback



- To fold the rear seatback forward, pull on the loops to fold down either or both seatbacks. When returning the rear seatback to the upright position, be sure the seatback is latched.

## HEATED SEATS

### Front Heated Seats

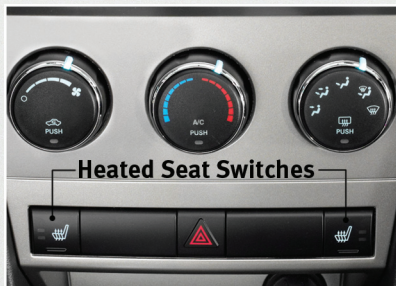

- The controls for the front heated seats are located in the center console below the climate controls.
- Press the switch once to select High-level heating. Press the switch a second time to select Low-level heating. Press the switch a third time to shut the heating elements Off.

## WARNING!

- Persons who are unable to feel pain to the skin because of advanced age, chronic illness, diabetes, spinal cord injury, medication, alcohol use, exhaustion or other physical conditions must exercise care when using the seat heater. It may cause burns even at low temperatures, especially if used for long periods of time.
- Do not place anything on the seat that insulates against heat, such as a blanket or cushion. This may cause the seat heater to overheat. Sitting in a seat that has been overheated could cause serious burns due to the increased surface temperature of the seat.

## CAUTION!

Repeated overheating of the seat could damage the heating element and/or degrade the material of the seat.



# GETTING STARTED

## TILT / TELESCOPING STEERING COLUMN



- The tilt/telescoping control lever is located below the steering wheel at the end of the steering column.
- Push down on the lever to unlock the steering column.
- To tilt the steering column, move the steering wheel upward or downward as desired. To lengthen or shorten the steering column, pull the steering wheel outward or push it inward as desired.

- Pull upward on the lever to lock the column firmly in place.

### WARNING!

Do not adjust the steering wheel while driving. The tilt/telescoping adjustment must be locked while driving. Adjusting the steering wheel while driving or driving without the tilt/telescoping adjustment locked could cause the driver to lose control of the vehicle. Failure to follow this warning may result in serious injury or death.

## PROGRAMMABLE FEATURES

### Electronic Vehicle Information Center (EVIC) – If Equipped

- The EVIC can be used to program the following Personal Settings. Press and release the MENU button **MENU** until Personal Settings displays, then press the STEP button **▼STEP** to scroll through the settings. Press the RESET button **►RESET** until ON or OFF appears.
  - Language
  - Auto Unlock On Exit
  - Remote Key Unlock
  - Sound Horn With LOCK
  - Flash Lights With LOCK
  - Headlights With Wipers
  - Headlamp Off Delay
  - Key Off Power Delay
  - ILLUMIN. Approach
  - Display Units Of Measure In

### Key Fob Programmable Features

- The following features may also be programmed by using the Key Fob transmitter or the ignition switch and driver's door lock switch.

**NOTE:** Pressing the LOCK button while you are inside the vehicle will activate the Vehicle Security Alarm. Opening a door with the Vehicle Security Alarm activated will cause the alarm to sound. Press the UNLOCK button to deactivate the Vehicle Security Alarm.



# GETTING STARTED

## Unlock On First Press

- To unlock either the driver's side, or all doors, on the first press of the UNLOCK button:
  - Press and hold the LOCK button for at least 4 seconds, but no longer than 10 seconds. Then, press and hold the UNLOCK button while still holding the LOCK button.
  - Release both buttons at the same time.

## Auto Unlock Doors On Exit

- To have all of the vehicle doors unlock when any door is opened:
  - Close all doors and place the key in the ignition.
  - Within 15 seconds, cycle the ignition switch between LOCK and ON and then back to LOCK four times, ending up in the LOCK position (do not start the engine).
  - Within 30 seconds, press the power door UNLOCK switch to unlock the doors.

## Auto Door Lock

- To have the doors lock automatically when the vehicle's speed exceeds 15 mph (24 km/h):
  - The auto door lock feature can be enabled or disabled by your authorized dealer. See your authorized dealer for programming.

## Sound Horn With Lock

- To turn the horn chirp on or off when the doors are locked:
  - Press the LOCK button for at least 4 seconds, but no longer than 10 seconds. Then, press the PANIC button while still holding the LOCK button.
  - Release both buttons at the same time.

## Flashing Lights With Lock

- The turn signal lights flashing, when the doors are locked or unlocked, feature can be turned on or off. To turn this feature on or off:
  - Press and hold the UNLOCK button for at least 4 seconds, but no longer than 10 seconds. Then, press and hold the LOCK button while still holding the UNLOCK button.
  - Release both buttons at the same time.





# OPERATING YOUR VEHICLE

## TURN SIGNAL/LIGHTS LEVER



### Headlights/Parking Lights/Automatic Headlights

- Rotate the end of the lever to the first detent for parking lights , the second detent for headlights  and the third detent for AUTO.
- When set to AUTO, the system automatically turns the headlights on or off based on ambient light levels.

### Instrument Panel Dimmer

- Rotate the center portion of the lever to the extreme bottom position to fully dim the instrument panel lights and prevent the interior lights from illuminating when a door is opened.
- Rotate the center portion of the lever up to increase the brightness of the instrument panel lights when the parking lights or headlights are on.
- Rotate the center portion of the lever upward to the next detent position to brighten the odometer and radio controls when the parking lights or headlights are on.
- Rotate the center portion of the lever upward to the last detent to turn on the interior lighting.

### High Beam Operation

- Push the lever forward to activate the high beams.

**NOTE:** For safe driving, turn off high beams when oncoming traffic is present to prevent headlight glare and as a courtesy to other motorists.

### Fog Lights

- Turn on the parking lights or low beam headlights and pull out the end of the lever.

### Turn Signals/Lane Change Assist

- Tap the lever up or down once and the turn signal (right or left) will flash three times and automatically turn off.



# OPERATING YOUR VEHICLE

## WIPER/WASHER LEVER



### Front Wipers

#### Intermittent, Low And High Operation

- Rotate the end of the lever to the first detent position for one of five intermittent settings, the second detent for low wiper operation and the third detent for high wiper operation.

#### Mist

- Pull down on the lever and release when a single wipe is desired.

#### Washer Operation

- Pull the lever toward you and hold for as long as spray is desired.

## SPEED CONTROL LEVER



### Cruise ON/OFF

- Push the ON/OFF button to activate the Speed Control.
- CRUISE will appear on the instrument cluster to indicate the Speed Control is on.
- Push the ON/OFF button a second time to turn the system off.



# OPERATING YOUR VEHICLE

## WARNING!

Leaving the Electronic Speed Control system on when not in use is dangerous. You could accidentally set the system or cause it to go faster than you want. You could lose control and have an accident. Always leave the Electronic Speed Control system off when you are not using it.

### Set

- With Speed Control on, push down and release the lever to set a desired speed.

## WARNING!

Electronic Speed Control can be dangerous where the system cannot maintain a constant speed. Your vehicle could go too fast for the conditions, and you could lose control. An accident could be the result. Do not use Electronic Speed Control in heavy traffic or on roads that are winding, icy, snow-covered or slippery.

### Accel/Decel

- Push and hold the lever up to accelerate or down to decelerate the vehicle; release the lever to save the new set speed.
- Once a speed is set, tapping the lever up or down will increase or decrease the set speed approximately 1 mph (2 km/h).

### Cancel

- Pull the lever toward you or apply the brakes to cancel the set speed and maintain the set speed in memory.
- Push the ON/OFF button to turn the system off and erase the set speed memory.

### Resume

- To resume a previously selected speed in memory, push the lever up and release.



# OPERATING YOUR VEHICLE

## MANUAL CLIMATE CONTROLS



### Air Recirculation

- Use recirculation for maximum A/C operation.
- For window defogging, turn the recirculation button off.
- Recirculation is not allowed in defrost, floor, defrost/floor (mix) modes.

## AUTOMATIC TEMPERATURE CONTROLS (ATC)

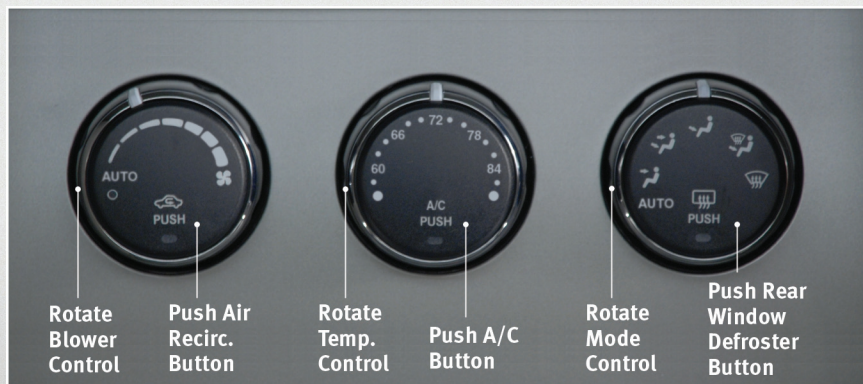

### Automatic Operation

- Turn the Mode and Blower Controls to the AUTO position.
- Select the desired temperature by rotating the Temperature Control.
- The system will maintain the set temperature automatically.



# OPERATING YOUR VEHICLE

## Air Conditioning

- If the air conditioning button is pressed while in the AUTO mode, the indicator light may flash three times to indicate the cabin air is being controlled automatically.

## Air Recirculation

- Use recirculation for maximum A/C operation.
- For window defogging, turn the air recirculation button off.
- If the recirculation button is pressed while in the AUTO mode, the indicator light may flash three times to indicate the cabin air is being controlled automatically.

## POWER SUNROOF

- The power sunroof switch is located on the overhead console.

### WARNING!

- Never leave children in a vehicle with the key in the ignition switch. Occupants, particularly unattended children, can become entrapped by the power sunroof while operating the power sunroof switch. Such entrapment may result in serious injury or death.
- In an accident, there is a greater risk of being thrown from a vehicle with an open sunroof. You could also be seriously injured or killed. Always fasten your seat belt properly and make sure all passengers are properly secured too.
- Do not allow small children to operate the sunroof. Never allow your fingers, other body parts, or any object to project through the sunroof opening. Injury may result.

## Opening Sunroof

### Express

- Press the switch rearward and release. The sunroof will fully open and stop automatically.

## Closing Sunroof

### Express

- Press the switch forward and release. The sunroof will close automatically from any position.

## Manual Open/Close

- Press and hold the switch rearward to open or forward to close the sunroof. Any release of the switch will stop the movement, and the sunroof will remain in a partially open or closed position until the switch is pressed again.

## Venting Sunroof

- Press and release the "VENT" button, and the sunroof will open to the vent position. This is called "Express Vent" and will occur regardless of sunroof position. During Express Vent operation, any movement of the switch will stop the sunroof.



# OPERATING YOUR VEHICLE

## Pinch Protection Feature

- This feature will detect an obstruction in the opening of the sunroof during Express Close operation. If an obstruction in the path of the sunroof is detected, the sunroof will automatically return to the open position.

**NOTE:** Pinch protection is disabled while the switch is pressed and held during manual opening and closing of the sunroof.

## WIND BUFFETING

- Wind buffeting can be described as a helicopter-type percussion sound. If buffeting occurs with the rear windows open, adjust the front and rear windows together.
- If buffeting occurs with the sunroof open, adjust the sunroof opening, or adjust any window. This will minimize buffeting.



## NON-TOUCH-SCREEN RADIOS

### Media Center 130 (RES)



### Media Center 130 (RES/RSC)

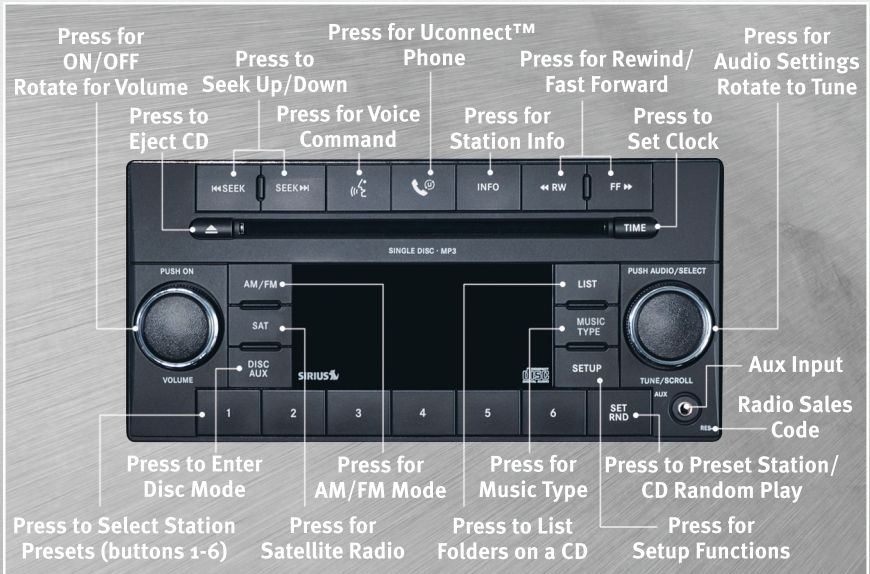



# ELECTRONICS

## Media Center 230 (REQ)



**NOTE:** Uconnect™ Phone and Voice Command are vehicle options which must be ordered separately. The buttons on the radio will only be active if the vehicle has been equipped with the option.

- The radio sales code is located on the lower right side of the radio faceplate.
- Unless otherwise noted, the information provided on the operation and functionality of the radios in this section is common to all non-touch-screen radios.

### Seek Up/Down Buttons

- Press to seek through radio stations in AM, FM or SAT bands. Seek through tracks in CD.
- Holding either button will bypass stations without stopping.

### Audio Settings

- Press the TUNE/SCROLL control knob and BASS, MID, TREBLE, BALANCE and FADE will display. Rotate the TUNE/SCROLL control knob to select the desired setting.



## Auxiliary Mode

- The auxiliary (AUX) jack allows a portable device, such as an MP3 player or a cassette player, to be plugged into the radio and utilize the vehicle's audio system to amplify the source and play through the vehicle speakers.
- Pressing the AUX button will change the mode to auxiliary device if the AUX jack is connected.
- The control of the external device cannot be provided by the radio; use the device controls instead.

## Clock Setting

- Press and hold the TIME button until the hours blink; turn the TUNE/SCROLL control knob to set the hours.
- Press the TUNE/SCROLL control knob until the minutes begin to blink; turn the TUNE/SCROLL control knob to set the minutes.
- Press the TUNE/SCROLL control knob to save the time change.
- To exit, press any button/knob or wait five seconds.

## Station Presets

- Press the SET/RND button once and SET 1 will show in the display. Then select the button (1–6).
- A second station may be added to each push button. Press the SET/RND button twice and SET 2 will show in the display, then select button (1–6).

## How To Load Multiple CDs/DVDs

### REQ Radio Only

- Press the LOAD button and then press the button with the corresponding number (1–6) where the CD is being loaded. The radio will display PLEASE WAIT and prompt when to INSERT DISC.
- After the radio displays INSERT DISC, insert the CD into the player. The radio display will show LOADING DISC when the disc is loading and "READING DISC" when the radio is reading the disc.
- Press the eject button and then the corresponding number (1–6) to eject the desired disc.



# ELECTRONICS

## TOUCH-SCREEN RADIOS

### Media Center 730N (RER)

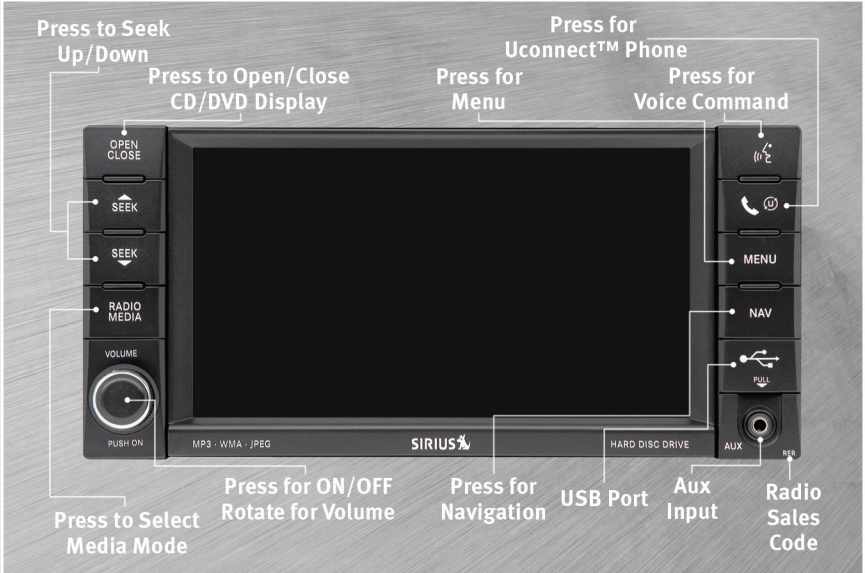

### Media Center 430 (REN)

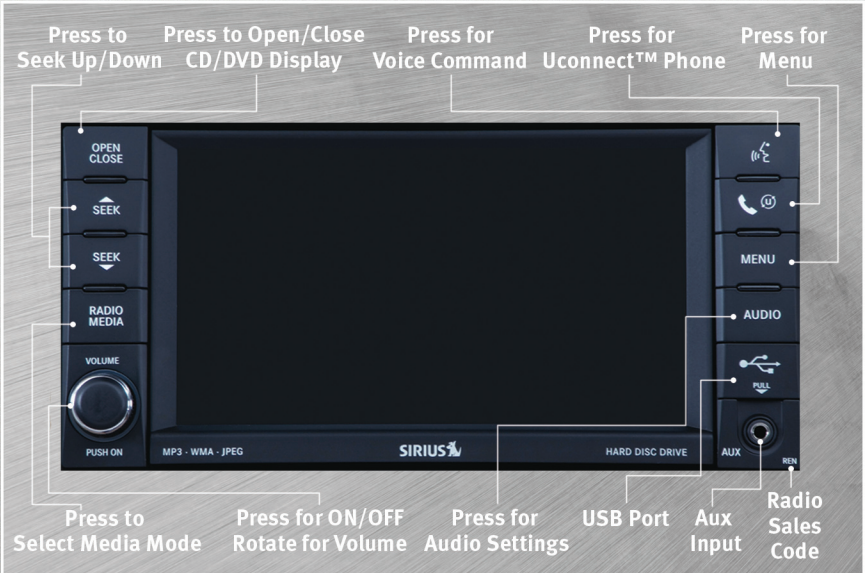



## Media Center 430 (RBZ)

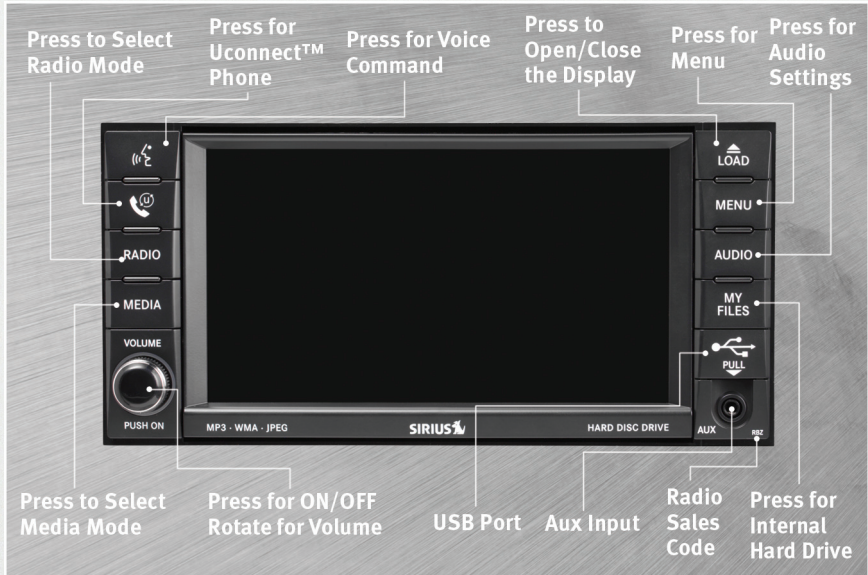

**NOTE:** Uconnect™ Phone and Voice Command are vehicle options which must be ordered separately. The buttons on the radio will only be active if the vehicle has been equipped with the option.

- The radio sales code is located on the lower right side of the radio faceplate.
- Unless otherwise noted, the information provided on the operation and functionality of the radios in this section is common to all touch-screen radios.

### Seek Up/Down

- REN and RER Radios – Press the SEEK hard-key to seek through radio stations in AM, FM, or SAT bands. Seek through tracks in CD or iPod® modes or through songs in the HDD playlist.
- RBZ Radio – Touch the SCAN soft-key, right or left arrow soft-keys to change the currently playing station in AM, FM or SAT bands.

### Radio Mode

- Press the RADIO/MEDIA (RER and REN) or RADIO (RBZ) hard-key to display the different radio modes, then press the desired soft-key to select AM, FM, SAT, HDD, Disk or AUX modes.

### Auxiliary Mode

- The auxiliary (AUX) jack allows a portable device, such as an MP3 player or a cassette player, to be plugged into the radio and utilize the vehicle's audio system to amplify the source and play through the vehicle speakers.



# ELECTRONICS

- The display will switch automatically to the AUX mode when a 3.5 mm stereo mini-jack cable has been connected.
- To change radio modes while the cable is connected to the unit, press the RADIO/MEDIA (RER and REN) or MEDIA (RBZ) hard-key until the AUX tab is displayed on the top of the screen. Touch the AUX tab to return to the AUX mode.
- The control of the external device cannot be provided by the radio; use the device controls instead.

## **Clock Setting**

- Turn the radio on, then touch the screen where the time is displayed.
- Touch the USER CLOCK soft-key (Navigation radio only).
- To adjust the hours, touch either the HOUR FORWARD or HOUR BACKWARD soft-key.
- To adjust the minutes, touch either the MINUTE FORWARD or MINUTE BACKWARD soft-key.
- To save the new time setting, touch the screen where the word “Save” is displayed.

## **Store Radio Presets**

- For REN and RER: Press the RADIO/MEDIA hard-key repeatedly until AM FM SAT is displayed in the upper left corner of the screen.
- For RBZ: Press the RADIO hard-key to display AM FM SAT in the upper left corner of the screen.
- Select the radio band by touching either the AM, FM, or SAT soft-key.
- Find the station to store by either pressing the SEEK UP/DOWN hard-key (REN and RER), touching the right and left arrow soft-keys (RBZ), touching the SCAN soft-key, or by using the DIRECT TUNE soft-key.
- Once the station is found, touch and hold one of the PRESET soft-keys in the list to the right, until you hear a confirmation beep.

## **Hard Disc Drive Operation**

### **Copy Complete Audio Disc To Hard-Drive**

- Press the OPEN/CLOSE hard-key (REN and RER) or LOAD hard-key (RBZ) and insert a disc, then press the MENU hard-key.
- Touch the MY FILES soft-key, then select MY MUSIC.
- Touch the IMPORT MUSIC soft-key, then touch the FROM DISC soft-key in the next screen to start the process.

### **Copying From USB**

- Insert a USB device, then select MY MUSIC.
- Touch the IMPORT MUSIC FILES soft-key, then touch the FROM USB soft-key in the next screen.
- Select the folders or titles you would like to copy, then touch the DONE soft-key to start the copy process.



## Copy Pictures To The Hard-Drive

- Insert either a CD or a USB device containing your pictures.
- Touch the MY FILES soft-key, then go to the MANAGE MY FILES screen.
- Touch the MY PICTURES soft-key to get an overview of the currently stored images.
- Touch one of the ADD PICTURES soft-keys, then select the type of media inserted.
- Use the PAGE soft-keys to page through a list of pictures and press the picture you would like to import.
- Confirm your selection by touching the YES soft-key. The imported picture is now available in the MANAGE MY PICTURES screen.
- In order to display the imported picture in the radio screen, touch the desired picture soft-key.
- Select this picture by pressing the PICTURE VIEW soft-key. A check mark indicates the currently used picture.

## Cleaning Your Touch-Screen Radio

- Do not spray any liquid or caustic chemicals directly on the screen. Use a clean and dry micro fiber lens cleaning cloth in order to clean the touch-screen.
- If necessary, use a lint-free cloth dampened with a cleaning solution such as isopropyl alcohol or an isopropyl alcohol and water solution ratio of 50:50. Be sure to follow the solvent manufacturer's precautions and directions.

## Navigation

### Navigation Radio – RER Only

- Navigation radios require digital data from a navigation database. The data in the navigation database is licensed from Navigation Technologies®. Not all roads are digitized.
- For software updates, visit <http://www.chrysler.com/en/owners/mygig/> website, visit <http://www.navteq.com> website, or contact your authorized dealer for the latest available software.

**NOTE:** Many features of this radio are speed dependent. For your own safety, it is not possible to use the touch-screen keyboard to enter a name (e.g., street name) while the vehicle is in motion. Pull over at a safe location to complete your task.

- The Navigation system receives GPS signals from satellites to display the position of your vehicle.

### New Destination

- Press the NAV hard-key to access the Navigation Main Menu.
- Touch the NEW DESTINATION soft-key to program a destination, then select the destination soft-key of your choice.



# ELECTRONICS

## **Program/Storing Home Address**

- Press the NAV hard-key to access the Navigation Main Menu.
- Touch the GUIDE ME HOME soft-key, then touch the STREET ADDRESS soft-key.
- Touch the STATE soft-key, then enter your state name into the speller; select your state from the list and press the CHANGE soft-key.
- Touch the INPUT STREET NAME soft-key and enter your street name into the speller.
- Touch the CONTINUE soft-key and enter your address into the speller; then touch the CONTINUE soft-key again.
- Touch the city name and touch the SAVE soft-key to complete programming.

## **Change Stored Home Address**

- Press the MENU hard-key, then touch the MY FILES soft-key.
- Touch the MY ADDRESS BOOK soft-key, then touch the HOME soft-key.
- In the Home Address Information screen, touch the EDIT CONTACT soft-key, then touch the CHANGE ADDRESS soft-key in the next screen.
- Touch the INPUT STREET NAME soft-key and enter your street name into the speller.
- Touch the CONTINUE soft-key and enter your address into the speller; touch the CONTINUE soft-key again.
- Touch the city name and touch the SAVE soft-key to complete programming.

## **Guide Me Home**

- Press the NAV hard-key to access the Navigation Main Menu.
- Touch the GUIDE ME HOME soft-key to route you back to your home destination from your current location. Touch the GO soft-key to start your trip.

## **Map**

- Press the NAV hard-key to access the Navigation Main Menu.
- Touch the MAP soft-key to display a map of your current position.



## REMOTE AUDIO CONTROLS



- The remote audio controls are located on the rear surface of the steering wheel.

### Right Switch

- Press the switch up or down to increase or decrease the volume.
- Press the button in the center to change modes AM/FM/CD/SAT.

### Left Switch

- Press the switch up or down to search for the next listenable station or select the next or previous CD track.
- Press the button in the center to select the next preset station (radio) or to change CDs if equipped with a CD Changer.

## ELECTRONIC VEHICLE INFORMATION CENTER (EVIC)



- The EVIC features a driver interactive display that is located in the instrument cluster. The system allows the driver to select information by pressing the buttons on the instrument panel switch bank located below the climate controls. For additional information refer to Programmable Features in this guide.

- Press and release the MENU **MENU** button to advance the display to Trip Functions or Personal settings or to return to the default System status display.

- Press and release the STEP **STEP** button to advance the display through the various Trip Functions or Personal settings.
- Press and release the COMPASS **COMPASS** button to display the compass heading and the outside temperature.
- Press and release the RESET **RESET** button to accept a selection. The RESET button also resets various Trip Functions.



# ELECTRONICS

## UNIVERSAL GARAGE DOOR OPENER (HomeLink®)



### Programming HomeLink®

#### Begin Programming

- The HomeLink® buttons are located in the overhead console.
  - Erase all channels before you begin training by holding the two outside buttons for up to 20 seconds until the red indicator flashes.
  - Park your vehicle outside of the garage and turn the ignition switch to the ON/RUN position.
- Place the hand-held transmitter 1 to 3 in (3 to 8 cm) from the HomeLink® buttons while keeping the indicator light in view.
  - Simultaneously, press and hold both the chosen HomeLink® button and the hand-held transmitter button until the HomeLink® indicator flash rate changes from a slow to a rapidly blinking light, then release both the HomeLink® and the hand-held transmitter buttons. This may take up to 30 seconds, or longer in rare cases.
  - Press and hold the just-trained HomeLink® button; if the indicator light stays on constantly, programming is complete and the garage door should open.

### WARNING!

- Your motorized door or gate will open and close while you are training the universal transceiver. Do not train the transceiver if people or pets are in the path of the door or gate. Only use this transceiver with a garage door opener that has a “stop and reverse” feature as required by Federal safety standards. This includes most garage door opener models manufactured after 1982. Do not use a garage door opener without these safety features. Call toll-free 1-800-355-3515 or, on the Internet, at [www.HomeLink.com](http://www.HomeLink.com) for safety information or assistance.
- Vehicle exhaust contains Carbon Monoxide (CO), a dangerous gas. Do not run your vehicle in the garage while training the transceiver. Exhaust gas can cause serious injury or death.

**NOTE:** If you are having difficulty training your HomeLink® and your garage door opener was manufactured after 1995, you may have a rolling code. Follow the steps below for Programming A Rolling Code System.



## Programming A Rolling Code System

- At the garage door opener motor (in the garage), locate the “learn” or “training” button. This can usually be found where the hanging antenna wire is attached to the garage door opener motor (it is NOT the button normally used to open and close the door).
- Firmly press and release the “learn” or “training” button. The name and color of the button may vary by manufacturer. Within 30 seconds, return to the vehicle and press the programmed HomeLink® button twice (holding the button for two seconds each time). If the device is plugged in and activates, programming is complete.
- If the device does not activate, press the button a third time (for two seconds) to complete the training.

## Using HomeLink®

- To operate, simply press and release the programmed HomeLink® button and the trained device will operate.
- Refer to your Owner’s Manual on the DVD for further details. If you have any problems programming HomeLink®, or require assistance, please call toll-free 1-800-355-3515 or, on the Internet, at [www.HomeLink.com](http://www.HomeLink.com).

## POWER OUTLET

- There are two 12 Volt electrical outlets on this vehicle.
- The outlet on the front console has power available only when the ignition is in the ON/RUN position. If desired, this outlet can be converted by your authorized dealer to provide power with the ignition switch in the LOCK position.
- The second outlet in the center console is powered directly from the battery (power available at all times). Items plugged into this outlet may discharge the battery and/or prevent engine starting.

**NOTE:** Do not exceed the maximum power of 160 Watts (13 Amps) at 12 Volts. If the 160 Watt (13 Amp) power rating is exceeded the fuse protecting the system will need to be replaced.

## Uconnect™ Phone

- The Uconnect™ Phone is a voice-activated, hands-free, in-vehicle communications system.
- The Uconnect™ Phone allows you to dial a phone number with your cellular phone using simple voice commands.
- For vehicles equipped with Video Entertainment System (VES)™, refer to the Uconnect™ Phone section of the Uconnect™ User’s Manual on the DVD for further details.
- For vehicles not equipped with VES™, refer to your vehicle Owner’s Manual on the DVD for further details.



## WARNING!

- Any voice commanded system should be used only in safe driving conditions following local laws and phone use. All attention should be kept on the roadway ahead. Failure to do so may result in an accident causing serious injury or death.
- Your phone must be turned on and paired to the Uconnect™ Phone to allow use of this vehicle feature in emergency situations, when the cellular phone has network coverage and stays paired to the Uconnect™ Phone.

**NOTE:** The Uconnect™ Phone requires a cellular phone equipped with the Bluetooth® Hands-Free Profile, Version 0.96 or higher. For Uconnect™ customer support, call 1-877-855-8400.

## Phone Pairing

**NOTE:** Pairing is a one-time initial setup before using the phone. You will also need to follow the Bluetooth® instructions in your cell phone user guide to complete the phone pairing setup.

- Press the Phone button  to begin.
- Wait for the “ready” prompt and beep.
- (After the BEEP), say “Uconnect setup”.
- (After the BEEP), say “phone pairing”.
- (After the BEEP), say “pair a phone”.
- Follow the audible prompts.
- You will be asked to enter a four-digit Personal Identification Number (PIN), which you will later need to enter into your cellular phone. You can enter any four-digit PIN. You will not need to remember this PIN after the initial pairing process.
- You will then be prompted to give the phone pairing a name (each phone paired should have a unique name).
- Next you will be asked to give this new pairing a priority of 1 thru 7 (up to seven phones may be paired).

## Making A Phone Call



- Press the Phone button .
- (After the BEEP), say “dial” (or “call” to a name).
- (After the BEEP), say number (or name).

## Phonebook (Uconnect™ Local) Edit

- Press the Phone button .
- (After the BEEP), say “phonebook”.
- (After the BEEP), say “new entry” or “list names” or “delete”.
- Follow the prompts.



## Receiving A Call – Accept (And End)

- When an incoming call rings/is announced on Uconnect™, press the Phone button .
- To end a call, press the Phone button .

## Mute (Or Unmute) Microphone During Call

- During a call, press the Voice Command button  VR .
- (After the BEEP), say “mute on” (or “mute off”).

## Transfer Ongoing Call Between Handset And Vehicle



- During a call, press the Voice Command button  VR .
- (After the BEEP), say “transfer call”.

## Changing The Volume

- Start a dialogue by pressing the Phone button , then adjust the volume during a normal call.
- Use the radio ON/OFF VOLUME rotary knob to adjust the volume to a comfortable level while the Uconnect™ system is speaking. Please note the volume setting for Uconnect™ is different than the audio system.

**NOTE:** To access the tutorial, press the Uconnect™ hard-key. After the BEEP, say “tutorial”. Press any hard-key or touch the display to cancel the tutorial.

## VOICE COMMAND

- The Voice Command system allows you to control your AM, FM radio, satellite radio, disc player, Uconnect™ Phone and a memo recorder. When you press the Voice Command button  VR , you will hear a beep. The beep is your signal to give a command. If you do not say a command within a few seconds, the system will present you with a list of options. If you ever wish to interrupt the system while it lists options, press the Voice Command button  VR , listen for the BEEP, and say your command.
- For vehicles equipped with Video Entertainment System (VES)™, refer to the Voice Command section of the Uconnect™ User's Manual on the DVD for further details.
- For vehicles not equipped with VES™, refer to your vehicle Owner's Manual on the DVD for Voice Command information.



# ELECTRONICS

## Changing The Volume

- Start a dialogue by pressing the Voice Command button  VR , then say a command (e.g., “tutorial”).
- Use the radio ON/OFF VOLUME rotary knob to adjust the volume to a comfortable level while the Voice Command system is speaking. Please note the volume setting for Voice Command is different than the audio system.

### WARNING!

Any voice commanded system should be used only in safe driving conditions and all attention should be kept on the roadway ahead. Failure to do so may result in an accident causing serious injury or death.

**NOTE:** To access the tutorial, press the Voice Command button  VR . After the BEEP, say “tutorial”. Press any hard-key or touch the display to cancel the tutorial.



## TRAILER TOWING WEIGHTS (MAXIMUM TRAILER WEIGHT RATINGS)

Maximum Trailer Weight Ratings			
Engine/Transaxle	Max. Frontal Area	Max. GTW (Gross Trailer Wt.)	Max. Trailer Tongue Wt. <sup>1</sup>
2.4L/Auto	See Note <sup>2</sup>	1,000 lbs (450 kg)	100 lbs (45 kg)
2.7L/Auto	See Note <sup>2</sup>	1,500 lbs (680 kg)	150 lbs (68 kg)
3.5L/Auto	22 sq.ft. (2.0 sq.m)	2,000 lbs (900 kg)	200 lbs (90 kg)

Refer to local laws for maximum trailer towing speeds.

<sup>1</sup> The trailer tongue weight must be considered as part of the combined weight of occupants and cargo, and it should never exceed the weight referenced on the Tire and Loading Information placard.

<sup>2</sup> Enclosed trailers or open utility trailers with front shields/guards are not recommended for use with all four-cylinder and 2.7L engines with automatic transaxle. Please see your authorized dealer for additional information.

### CAUTION!

Towing a trailer with a larger than recommended frontal area could cause the engine to overheat or cause severe engine damage under extreme conditions.



# UTILITY

## RECREATIONAL TOWING (BEHIND MOTORHOME, ETC.)

### Towing This Vehicle Behind Another Vehicle (Flat Towing With All Four Wheels On The Ground)

#### CAUTION!

DO NOT flat tow this vehicle. Damage to the drivetrain will result.

**NOTE:** If the vehicle requires towing, make sure all four wheels are off the ground.

## BRAKE/TRANSAXLE INTERLOCK MANUAL OVERRIDE

- The manual override may be used in the event that the shift lever should fail to move from PARK with the Key Fob in the ON position and the brake pedal pressed.

- To operate the shift lock manual override, perform the following steps:
  - Firmly apply the parking brake, insert the ignition Key Fob and rotate it to the ON position.
  - Remove the cup holder liner.
  - Insert a key, screwdriver, or finger into the front hole then push and hold the manual override release lever forward.
  - While holding the release lever forward, move the shift lever from PARK to NEUTRAL. Release the override.
  - Release the parking brake.
- Have your vehicle inspected by your local authorized dealer if the shift lock manual override has been used.

**NOTE:** If a malfunction occurs, the system will trap the Key Fob in the ignition cylinder to warn you that this safety feature is inoperable. The engine can be started and stopped, but the Key Fob cannot be removed until you obtain service.



# WHAT TO DO IN EMERGENCIES

## 24-HOUR TOWING ASSISTANCE - U.S. ONLY

- Dial toll-free 1-800-521-2779 or 1-800-363-4869 for Canadian residents.
- Provide your name, vehicle identification number and license plate number.
- Provide your location, including telephone number, from which you are calling.
- Briefly describe the nature of the problem and answer a few simple questions.
- You will be given the name of the service provider and an estimated time of arrival. If you feel you are in an “unsafe situation”, please let us know. With your consent, we will contact local police or safety authorities.

## INSTRUMENT CLUSTER WARNING LIGHTS

### - Electronic Stability Control (ESC) Activation/Malfunction Indicator Light

- If the “ESC Activation/Malfunction Indicator Light” comes on continuously with the engine running, a malfunction has been detected in the ESC system. If this light remains on after several ignition cycles, and the vehicle has been driven several miles (kilometers) at speeds greater than 30 mph (48 km/h), we recommend you do not operate the vehicle. Have the vehicle serviced immediately.
- The “ESC Activation/Malfunction Indicator Light” starts to flash as soon as the tires lose traction and the ESC system becomes active. If the light begins to flash during acceleration, ease up on the accelerator and apply as little throttle as possible. Be sure to adapt your speed and driving to the prevailing road conditions. The light also flashes when TCS is active. To improve the vehicle's traction when starting off in deep snow, sand or gravel, it may be desirable to switch the ESC system to Partial Off mode by momentarily pressing the ESC Off  switch.

### - Tire Pressure Monitoring System (TPMS) Light

- A Tire Pressure Monitoring Light and a “low tire” message will display in your instrument cluster along with an audible chime if one or more of your vehicle's four road tires are significantly under-inflated.
- Check the inflation pressure of each tire and inflate to the recommended pressure for your vehicle. The tire pressures recommended for your vehicle are found on the “Tire and Loading Information” label located on the driver's side door opening. The TPMS light should not be used as a tire pressure gauge when adjusting your tire pressure.
- It is recommended that you check the tire pressure once a month in the morning when tires are cool; inflate each tire to the recommended pressure for your vehicle. The light will turn off after your vehicle's tire pressures are properly inflated and the pressure has been recognized. The vehicle may need to be driven for up to 20 minutes above 15 mph (25 km/h) before the light will turn off.
- Temperature changes can affect tire pressure, causing the TPMS light to turn on. Tire pressures will also increase as the vehicle is driven – this is normal and you should not adjust for this increased pressure.



# WHAT TO DO IN EMERGENCIES

- Driving on under-inflated tires reduces your vehicle's fuel efficiency and tire tread life. If a spare tire is in use on the vehicle, the TPMS light may turn on.

## - Engine Temperature Warning Light

- This light warns of an overheated engine condition.
- If the light turns on or flashes continuously while driving, safely pull over and stop the vehicle. If the A/C system is on, turn it off. Also, shift the transmission into NEUTRAL and idle the vehicle. If the temperature reading does not return to normal, turn the engine off immediately.
- We recommend that you do not operate the vehicle or engine damage will occur. Have the vehicle serviced immediately.

### WARNING!

A hot engine cooling system is dangerous. You or others could be badly burned by steam or boiling coolant. You may want to call an authorized dealership for service if your vehicle overheats.

## **BRAKE - Brake Warning Light**

- The Brake Warning light illuminates when there is either a system malfunction or the parking brake is applied. If the light is on and the parking brake is not applied, it indicates a possible brake hydraulic malfunction, brake booster problem or an Anti-Lock Brake System problem.
- We recommend you drive to the nearest service center and have the vehicle serviced immediately.

### WARNING!

Driving a vehicle with the red brake light on is dangerous. Part of the brake system may have failed. It will take longer to stop the vehicle. You could have an accident. Have the vehicle checked immediately.

## - Malfunction Indicator Light (MIL)

- Certain conditions, such as a loose or missing gas cap, poor fuel quality, etc., may illuminate the MIL after engine start. The vehicle should be serviced if the light stays on through several typical driving cycles. In most situations, the vehicle will drive normally and not require towing.
- If the MIL flashes when the engine is running, serious conditions may exist that could lead to immediate loss of power or severe catalytic converter damage. We recommend you do not operate the vehicle. Have the vehicle serviced immediately.



# WHAT TO DO IN EMERGENCIES

## - Charging System Light

- This light shows the status of the electrical charging system. If the charging system light remains on, it means that the vehicle is experiencing a problem with the charging system.
- We recommend you do not continue driving if the charging system light is on. Have the vehicle serviced immediately.

## - Oil Pressure Warning Light

- This light indicates low engine oil pressure. If the light turns on while driving, stop the vehicle and shut off the engine as soon as possible. A chime will sound for four minutes when this light turns on.
- We recommend you do not operate the vehicle or engine damage will occur. Have the vehicle serviced immediately.

## - Anti-Lock Brake (ABS) Light

- This light monitors the Anti-Lock Brake System (ABS).
- If the light is not on during starting, stays on, or turns on while driving, we recommend you drive to the nearest service center and have the vehicle serviced immediately.

## - Electronic Throttle Control (ETC) Light

- This light informs you of a problem with the Electronic Throttle Control (ETC) system.
- If a problem is detected, the light will come on while the engine is running. Cycle the ignition when the vehicle has completely stopped and the shift lever is placed in the PARK position; the light should turn off.
- If the light remains lit with the engine running, your vehicle will usually be drivable; however, see an authorized dealer for service immediately. If the light is flashing when the engine is running, immediate service is required and you may experience reduced performance, an elevated/rough idle or engine stall and your vehicle may require towing.

## - Transmission Temperature Warning Light

- This light indicates that there is excessive transmission fluid temperature that might occur with severe usage such as trailer towing. If this light turns on, stop the vehicle and run the engine at idle, with the transmission in NEUTRAL, until the light turns off. Once the light turns off, you may continue to drive normally.

## - Airbag Warning Light

- If the light is not on during starting, stays on, or turns on while driving, we recommend you drive to the nearest service center and have the vehicle serviced immediately.



# WHAT TO DO IN EMERGENCIES

## Fuel Cap/Loose Gas Cap Message

- If a “gas cap” message (shown as gASCAP) appears, tighten the gas cap until a “clicking” sound is heard.
- Press the odometer reset button to turn the message off.
- If the message continues to appear for more than three days after tightening the gas cap, see your authorized dealer.

## Oil Change Indicator

### Message

- If an “oil change” message (shown as CHAngE OIL) appears and a single chime sounds, it is time for your next required oil change.

### Resetting The Light After Servicing

- Turn the ignition switch to the ON/RUN position (do not start engine).
- Fully depress the accelerator pedal three times within 10 seconds.
- Turn the ignition switch to the OFF/LOCK position.

## IF YOUR ENGINE OVERHEATS

- In any of the following situations, you can reduce the potential for overheating by taking the appropriate action.
  - On the highways — slow down.
  - In city traffic — while stopped, shift transmission into NEUTRAL, but do not increase engine idle speed.

**NOTE:** There are steps that you can take to slow down an impending overheat condition:

- If your air conditioner (A/C) is on, turn it off. The A/C system adds heat to the engine cooling system and turning the A/C off can help remove this heat.
- You can also turn the Temperature Control to maximum heat, the Mode Control to floor and the Fan Control to high. This allows the heater core to act as a supplement to the radiator and aids in removing heat from the engine cooling system.
- If the temperature reading does not return to normal, turn the engine off immediately.
- We recommend that you do not operate the vehicle or engine damage will occur. Have the vehicle serviced immediately.

### CAUTION!

Driving with a hot cooling system could damage your vehicle. If the temperature gauge reads HOT (H), pull over and stop the vehicle. Idle the vehicle with the air conditioner turned off until the pointer drops back into the normal range. If the pointer remains on HOT (H), and you hear continuous chimes, turn the engine off immediately, and call for service.



# WHAT TO DO IN EMERGENCIES

## WARNING!

You or others can be badly burned by hot engine coolant (antifreeze) or steam from your radiator. If you see or hear steam coming from under the hood, do not open the hood until the radiator has had time to cool. Never try to open a cooling system pressure cap when the radiator or coolant bottle is hot.

## Engine Oil Overheating — 2.4L Gas

- On hot days the engine oil temperature may become too hot during sustained high-speed driving or if towing a trailer up long grades. If this happens, a HOTOIL message will flash in the odometer and the vehicle speed will be reduced to 48 mph (77 km/h) maximum until the engine oil temperature is reduced.

**NOTE:** Although the maximum vehicle speed is reduced to 48 mph (77 km/h), you may reduce vehicle speed further as needed. Once the engine oil temperature is reduced, you may continue to drive normally.

## JACKING AND TIRE CHANGING

### WARNING!

- Do not attempt to change a tire on the side of the vehicle close to moving traffic. Pull far enough off the road to avoid the danger of being hit when operating the jack or changing the wheel.
- Getting under a jacked-up vehicle is dangerous. The vehicle could slip off the jack and fall on you. You could be crushed. Never get any part of your body under a vehicle that is on a jack. If you need to get under a raised vehicle, take it to a service center where it can be raised on a lift.
- The jack is designed to use as a tool for changing tires only. The jack should not be used to lift the vehicle for service purposes. The vehicle should be jacked on a firm, level surface only. Avoid ice or slippery areas.



# WHAT TO DO IN EMERGENCIES

## Jack Location

- The jack and jack-handle are stowed under the load floor in the trunk.

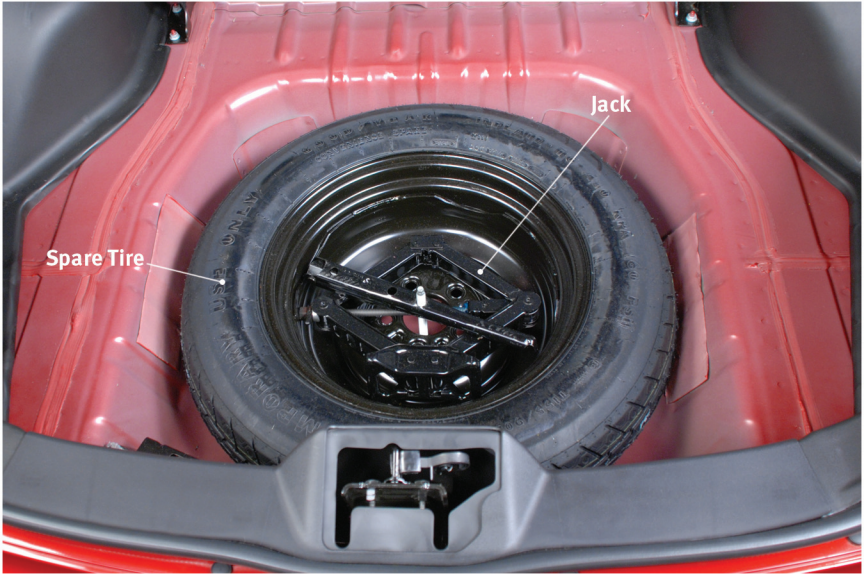

## Spare Tire Stowage

- The compact spare tire is stowed under the rear load floor in the trunk.
- To remove the spare tire, lift up the load floor cover and remove the hold down.

## Preparations For Jacking

- Park on a firm, level surface. Avoid ice or slippery areas.

### WARNING!

Do not attempt to change a tire on the side of the vehicle close to moving traffic. Pull far enough off the road to avoid being hit when operating the jack or changing the wheel.



# WHAT TO DO IN EMERGENCIES

- Set the parking brake and shift the automatic transmission into PARK.
- Turn the ignition to LOCK and turn on the Hazard Warning flasher.

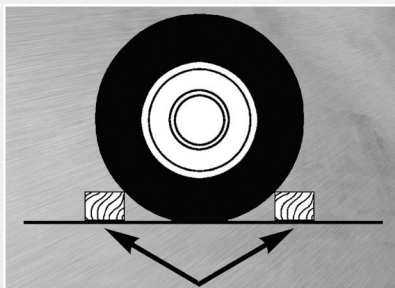

- Block both the front and rear of the wheel diagonally opposite of the jacking position. For example, if changing the right front tire, block the left rear wheel.

**NOTE:** Passengers should not remain in the vehicle when the vehicle is being jacked.

## Jacking And Tire Changing Instructions

### WARNING!

Carefully follow these tire changing procedures to help prevent personal injury or damage to your vehicle: Always park on a firm, level surface as far from the edge of the roadway as possible before raising the vehicle.

- Remove the scissors jack and lug wrench from the spare wheel as an assembly. Turn the jack screw counterclockwise to loosen the lug wrench, and remove the wrench from the jack assembly.

**NOTE:** The jack handle attaches to the side of the jack with two attachment points. When the jack is partially expanded, the tension between the two attachment points holds the jack handle in place.

- Loosen (but do not remove) the wheel lug nuts by turning them counterclockwise one turn while the wheel is still on the ground.
- Assemble the jack and jacking tools. Connect the jack handle driver to the extension, then to the lug wrench.



# WHAT TO DO IN EMERGENCIES

- Place the jack underneath the lift area that is closest to the flat tire. Turn the jack screw clockwise to firmly engage the jack saddle with the lift area of the sill flange.

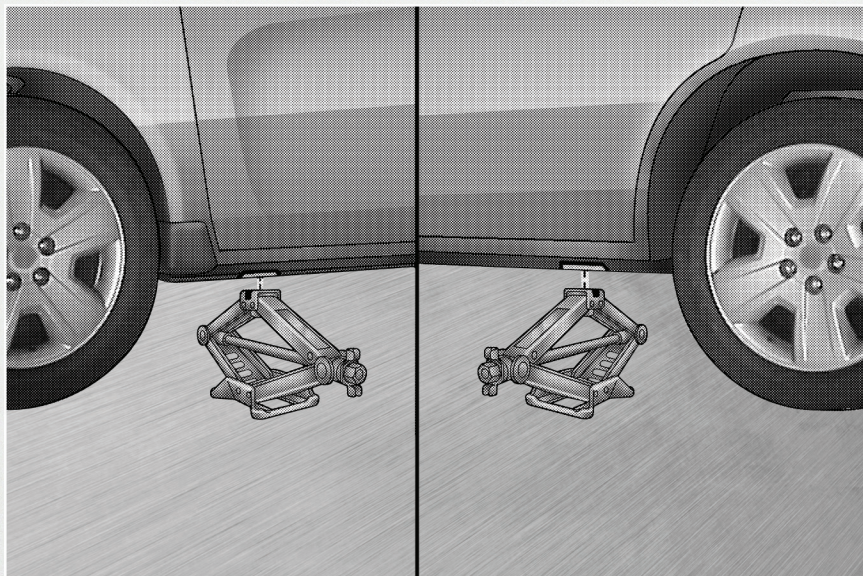

- Raise the vehicle by turning the jack screw clockwise. Raise the vehicle only until the tire just clears the surface and enough clearance is obtained to install the spare tire.

## WARNING!

Raising the vehicle higher than necessary can make the vehicle less stable and cause an accident. It could slip off the jack and hurt someone near it. Raise the vehicle only enough to remove the tire.

- Remove the lug nuts, wheel cover (if equipped) and wheel.
- Position the spare wheel/tire on the vehicle and install the lug nuts with the cone-shaped end toward the wheel. Do NOT attempt to install a center cap or wheel cover on the compact spare. Lightly tighten the lug nuts clockwise. To avoid the risk of forcing the vehicle off the jack, do not tighten the nuts fully until the vehicle has been lowered.
- Lower the vehicle by turning the jack screw counterclockwise, and remove the jack and wheel blocks.
- Finish tightening the lug nuts. Push down on the wrench while tightening for increased leverage. Alternate nuts until each one has been tightened twice. The correct wheel nut tightness is 100 ft lbs (135 N•m). If in doubt about the correct tightness, have them checked with a torque wrench by your authorized dealer or at a service station.



# WHAT TO DO IN EMERGENCIES

## WARNING!

A loose tire or jack, thrown forward in a collision or hard stop, could endanger the occupants of the vehicle. Always stow the jack parts and the spare tire in the places provided.

- Secure the tire, jack and tools in their proper locations.

## JUMP-STARTING



- If your vehicle has a discharged battery it can be jump-started using a set of jumper cables and a battery in another vehicle or by using a portable battery booster pack.
- Jump-starting can be dangerous if done improperly so please follow the procedures in this section carefully.

**NOTE:** When using a portable battery booster pack follow the manufacturer's operating instructions and precautions.

## CAUTION!

Do not use a portable battery booster pack or any other booster source with a system voltage greater than 12 Volts or damage to the battery, starter motor, alternator or electrical system may occur.



# WHAT TO DO IN EMERGENCIES

## WARNING!

When temperatures are below the freezing point, electrolyte in a discharged battery may freeze. Do not attempt jump-starting because the battery could rupture or explode and cause personal injury. Battery temperature must be brought above the freezing point before attempting a jump-start.

## Preparations for Jump-Start

- The battery in your vehicle is located between the left front headlight assembly and the left front wheel splash shield. To allow jump-starting there are remote battery posts located on the left side of the engine compartment.

## WARNING!

- Take care to avoid the radiator cooling fan whenever the hood is raised. It can start anytime the ignition switch is on. You can be injured by moving fan blades.
  - Remove any metal jewelry, such as watch bands or bracelets, that might make an inadvertent electrical contact. You could be seriously injured.
  - Batteries contain sulfuric acid that can burn your skin or eyes and generate hydrogen gas which is flammable and explosive. Keep open flames or sparks away from the battery.
- Set the parking brake, shift the automatic transmission into PARK and turn the ignition to LOCK.
  - Turn off the heater, radio, and all unnecessary electrical accessories.
  - Remove the protective cover over the remote positive (+) battery post. To remove the cover, press the locking tab and pull upward on the cover.
  - If using another vehicle to jump-start the battery, park the vehicle within the jumper cables reach, set the parking brake and make sure the ignition is OFF.

## WARNING!

WARNING! Do not allow vehicles to touch each other as this could establish a ground connection and personal injury could result.



# WHAT TO DO IN EMERGENCIES

## Jump-Starting Procedure

### WARNING!

Failure to follow this procedure could result in personal injury or property damage due to battery explosion.

### CAUTION!

Failure to follow these procedures could result in damage to the charging system of the booster vehicle or the discharged vehicle.

- Connect the positive (+) end of the jumper cable to the remote positive (+) post of the discharged vehicle.
- Connect the opposite end of the positive (+) jumper cable to the positive (+) post of the booster battery.
- Connect the negative end (-) of the jumper cable to the negative (-) post of the booster battery.
- Connect the opposite end of the negative (-) jumper cable to the remote negative (-) post of the vehicle with the discharged battery.

### WARNING!

Do not connect the cable to the negative post (-) of the discharged battery. The resulting electrical spark could cause the battery to explode and could result in personal injury.

- Start the engine in the vehicle that has the booster battery, let the engine idle a few minutes, and then start the engine in the vehicle with the discharged battery. Once the engine is started, remove the jumper cables in the reverse sequence:
- Disconnect the negative (-) jumper cable from the remote negative (-) post of the vehicle with the discharged battery.
- Disconnect the negative end (-) of the jumper cable from the negative (-) post of the booster battery.
- Disconnect the opposite end of the positive (+) jumper cable from the positive (+) post of the booster battery.
- Disconnect the positive (+) end of the jumper cable from the remote positive (+) post of the discharged vehicle.



# WHAT TO DO IN EMERGENCIES

- Reinstall the protective cover over the remote positive (+) battery post of the discharged vehicle.
- If frequent jump-starting is required to start your vehicle you should have the battery and charging system inspected at your authorized dealer.

## CAUTION!

Accessories that can be plugged into the vehicle power outlets draw power from the vehicle's battery, even when not in use (i.e., cellular phones, etc.). Eventually, if plugged in long enough, the vehicle's battery will discharge sufficiently to degrade battery life and/or prevent the engine from starting.



# WHAT TO DO IN EMERGENCIES

## TOWING A DISABLED VEHICLE

Model	Flat Towing (all four wheels on the ground)	Flatbed Towing (all four wheels suspended OFF the ground)	Front Wheels Raised, Rear Wheels on the Ground	Rear Wheels Raised, Front Wheels on the Ground
<b>FWD Without a Key</b>	NOT Permitted	Recommended Method	May Be Used	NOT Permitted without a front end dolly
<b>FWD With a Key</b>	Shift lever must be in *NEUTRAL. The distance to be traveled must not exceed 15 mi (25 km), and the towing speed must not exceed 25 mph (40 km/h).	Recommended Method	May Be Used	NOT Permitted without a front end dolly

\*To shift to NEUTRAL without battery power, firmly apply the parking brake. Turn the key to ON. Remove the cupholder liner. Insert a key, screwdriver or similar object into the front hole, then push and hold the manual override release lever forward. While holding the release lever forward, move the shift lever from PARK to NEUTRAL. Release the override.



# WHAT TO DO IN EMERGENCIES

## FREEING A STUCK VEHICLE

- If your vehicle becomes stuck in mud, sand or snow, it can often be moved by a rocking motion. Turn your steering wheel right and left to clear the area around the front wheels. Then move the shift lever back and forth between REVERSE and DRIVE. Using minimal accelerator pedal pressure to maintain the rocking motion, without spinning the wheels, is most effective.

**NOTE:** To improve the vehicle's traction when starting off in deep snow, sand or gravel, it may be desirable to switch the Electronic Stability Control (ESC) to "Partial Off" mode by momentarily pressing the ESC Off  switch. For further information on ESC, refer to the Owner's Manual on the DVD.

### WARNING!

Fast spinning tires can be dangerous. Forces generated by excessive wheel speeds may cause tire damage or failure. A tire could explode and injure someone. Do not spin your vehicle's wheels faster than 30 mph (48 km/h) when you are stuck. Do not let anyone near a spinning wheel, no matter what the speed.

### CAUTION!

- When "rocking" a stuck vehicle by moving between 1st and REVERSE, do not spin the wheels faster than 15 mph (24 km/h), or drivetrain damage may result.
- Revving the engine or spinning the wheels too fast may lead to transmission overheating and failure. It can also damage the tires. Do not spin the wheels above 30 mph (48 km/h) while in gear (no transmission shifting occurring).



# WHAT TO DO IN EMERGENCIES

## EVENT DATA RECORDER (EDR)

- In the event of an accident, your vehicle is designed to record up to five seconds of specific vehicle data parameters (see list below) in an event data recorder prior to the moment of airbag deployment, or near deployment (if applicable), and up to a quarter second of either high-speed deceleration data or change in velocity during and/or after airbag deployment or near-deployment. EDR data is ONLY recorded if an airbag deploys, or nearly deploys, and is otherwise unavailable.

### NOTE:

- A near-deployment event occurs when the airbag sensor detects severe vehicle deceleration usually indicative of a crash, but not severe enough to warrant airbag deployment.
- Under certain circumstances, EDR data may not be recorded (e.g., loss of battery power).
- In conjunction with other data gathered during a complete accident investigation, the electronic data may be used by Chrysler Group LLC and others to learn more about the possible causes of crashes and associated injuries in order to assess and improve vehicle performance. In addition to crash investigations initiated by Chrysler Group LLC, such investigations may be requested by customers, insurance carriers, government officials, and professional crash researchers, such as those associated with universities, and with hospital and insurance organizations.
- In the event that an investigation is undertaken by Chrysler Group LLC (regardless of initiative), the company or its designated representative will first obtain permission of the appropriate custodial entity for the vehicle (usually the vehicle owner or lessee) before accessing the electronic data stored, unless ordered to image the data by a court with legal jurisdiction (i.e., pursuant to a warrant). A copy of the data will be provided to the custodial entity upon request. General data that does not identify particular vehicles or crashes may be released for incorporation in aggregate crash databases, such as those maintained by the U.S. government and various states. Data of a potentially sensitive nature, such as would identify a particular driver, vehicle, or crash, will be treated confidentially. Confidential data will not be disclosed by Chrysler Group LLC to any third party except when:
  - Used for research purposes, such as to match data with a particular crash record in an aggregate database, provided confidentiality of personal data is thereafter preserved.
  - Used in defense of litigation involving a Chrysler Group LLC product.
  - Requested by police under a legal warrant.
  - Otherwise required by law.

### Data parameters that are recorded:

- Diagnostic trouble code(s) and warning light status for electronically-controlled safety systems, including the airbag system.
- Vehicle speed, Engine RPM, Brake switch status, Pedal position, and other parameters depending on vehicle configuration.



# MAINTAINING YOUR VEHICLE

## OPENING THE HOOD

- Pull the release lever located below the instrument panel and in front of the driver's door.
- Raise the hood and locate the safety latch, in the middle of the hood opening.
- Move the safety latch while lifting the hood at the same time.
- Insert the support rod into the slot on the hood.
- To close the hood, remove the support rod and place it in the retaining clip, then lower the hood slowly.

### WARNING!

Be sure the hood is fully latched before driving your vehicle. If the hood is not fully latched, it could open when the vehicle is in motion and block your vision. Failure to follow this warning could result in serious injury or death.



# MAINTAINING YOUR VEHICLE

## ENGINE COMPARTMENT

### 2.4L Engine

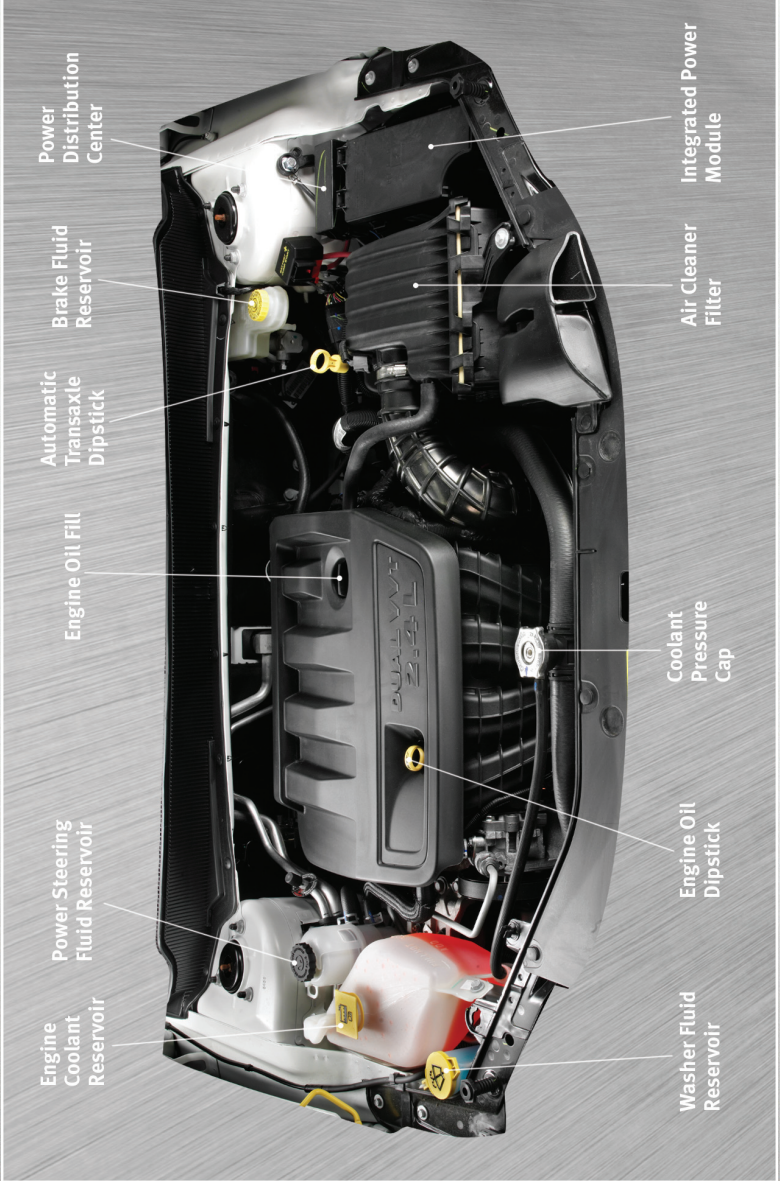



# MAINTAINING YOUR VEHICLE

## 2.7L Engine

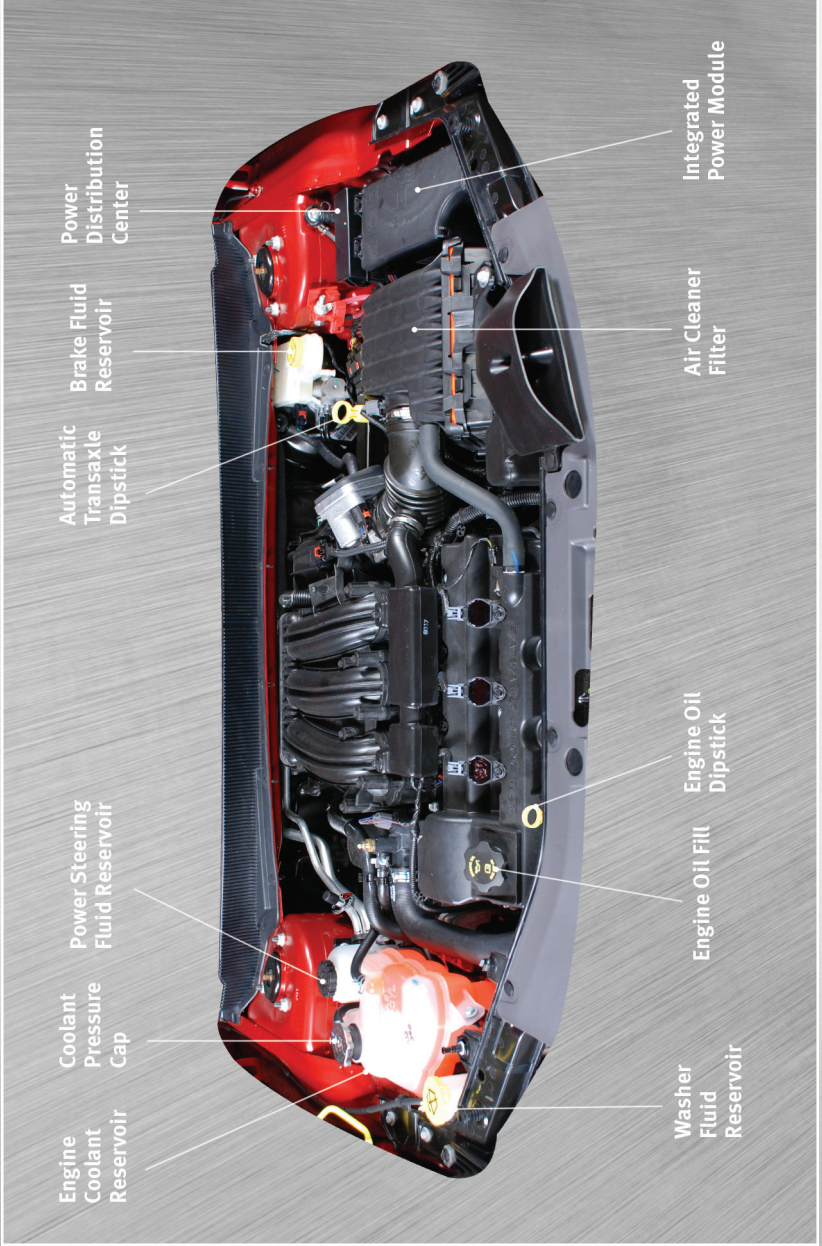



# MAINTAINING YOUR VEHICLE

## 3.5L Engine

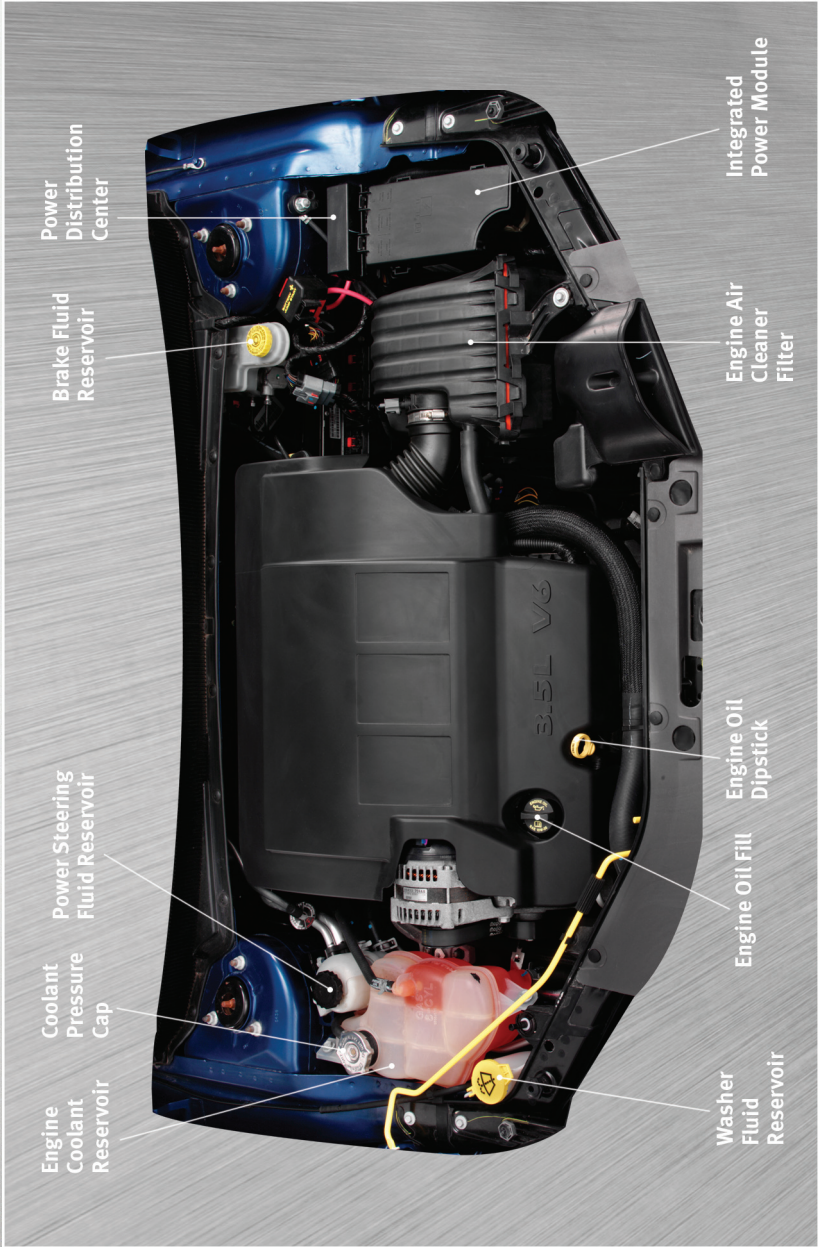



# MAINTAINING YOUR VEHICLE

## FLUIDS AND CAPACITIES

Component	Fluid, Lubricant, or Genuine Part	Capacities
Engine Coolant 2.4L	MOPAR® Antifreeze/ Coolant Five Year/100,000 Mile Formula HOAT (Hybrid Organic Additive Technology) or equivalent.	7.7 Quarts (7.3 Liters) Includes heater and coolant recovery bottle filled to MAX level.
Engine Coolant 2.7L	MOPAR® Antifreeze/ Coolant Five Year/100,000 Mile Formula HOAT (Hybrid Organic Additive Technology) or equivalent.	9.8 Quarts (9.3 Liters) Includes heater and coolant recovery bottle filled to MAX level.
Engine Coolant 3.5L	MOPAR® Antifreeze/ Coolant Five Year/100,000 Mile Formula HOAT (Hybrid Organic Additive Technology) or equivalent.	11.6 Quarts (11 Liters) Includes heater and coolant recovery bottle filled to MAX level.
Engine Oil with Filter 2.4L	API Certified SAE 5W-20 engine oil, meeting the requirements of Chrysler Material Standard MS-6395. Refer to the engine oil filler cap for correct SAE grade.	4.5 Quarts (4.4 Liters)
Engine Oil with Filter 2.7L	API Certified SAE 5W-20 engine oil, meeting the requirements of Chrysler Material Standard MS-6395. Refer to the engine oil filler cap for correct SAE grade.	5.5 Quarts (5.2 Liters)
Engine Oil with Filter 3.5L	API Certified SAE 10W-30 engine oil, meeting Chrysler Material Standard MS-6395. Refer to your engine oil filler cap for correct SAE grade.	5.5 Quarts (5.2 Liters)
Fuel Selection 2.4L non Partial Zero Emissions Vehicle (PZEV), 2.7L, 3.5L	2.4L, 2.7L 87 Octane. 3.5L 87 Octane acceptable. 89 Octane recommended.	16.9 Gallons (64 Liters)
Fuel Selection 2.4L PZEV	87 Octane	18.5 Gallons (70 Liters)
Engine Oil Filter 2.4L, 2.7L, 3.5L	MOPAR® Engine Oil Filter or equivalent.	—



# MAINTAINING YOUR VEHICLE

Component	Fluid, Lubricant, or Genuine Part	Capacities
Spark Plugs 2.4L except PZEV	ZFR5F-11 (Gap 0.043 in [1.11 mm])	—
Spark Plugs 2.4L with PZEV	ZFR5AP (Gap 0.031 in [0.8 mm])	—
Spark Plugs 2.7L	TE10PMC5 (Gap 0.050 in [1.27 mm])	—
Spark Plugs 3.5L	ZFR5LP-13G (Gap 0.050 in [1.27 mm])	—
Automatic Transaxle	MOPAR <sup>®</sup> ATF+4 <sup>®</sup> Automatic Transmission Fluid or equivalent licensed ATF+4 <sup>®</sup> product.	—
Brake Master Cylinder	MOPAR <sup>®</sup> DOT 3 and SAE J1703 should be used or equivalent. If DOT 3 is not available, then DOT 4 is acceptable. Use only recommended brake fluids.	—
Power Steering Reservoir	MOPAR <sup>®</sup> Power Steering Fluid + 4 or MOPAR <sup>®</sup> ATF+4 <sup>®</sup> Automatic Transmission Fluid or equivalent licensed ATF+4 <sup>®</sup> product.	—



# MAINTAINING YOUR VEHICLE

## MAINTENANCE CHART

Miles:	6,000	12,000	18,000	24,000	30,000	36,000	42,000	48,000	54,000	60,000	66,000	72,000	78,000
Or Months:	6	12	18	24	30	36	42	48	54	60	66	72	78
Or Kilometers:	10,000	20,000	30,000	40,000	50,000	60,000	70,000	80,000	90,000	100,000	110,000	120,000	130,000
Change the engine oil and filter.	X	X	X	X	X	X	X	X	X	X	X	X	X
Rotate the tires.	X	X	X	X	X	X	X	X	X	X	X	X	X
If using your vehicle for any of the following: dusty or off-road conditions. Inspect the engine air cleaner filter; replace if necessary.		X		X		X		X				X	
Replace the air conditioning filter (if equipped).		X		X		X		X		X		X	
Inspect the brake linings; replace if necessary.		X		X		X		X		X		X	
Inspect the CV joints. Perform the first inspection at 12,000 miles (20,000 km) or 12 months.		X		X				X				X	
Inspect the exhaust system. Perform the first inspection at 12,000 miles (20,000 km) or 12 months.		X		X				X				X	
Replace the engine air cleaner filter.					X					X			
Adjust the parking brake on vehicles equipped with four wheel disc brakes.					X					X			
Change the automatic transmission fluid and filter if using your vehicle for any of the following: police, taxi, fleet or frequent trailer towing.										X			
Inspect the front suspension, tie rod ends and boot seals for cracks or leaks and all parts for damage, wear, improper looseness or end play; replace if necessary.		X		X		X		X		X		X	
Replace the spark plugs (2.4L engine except PZEV).					X					X			

- Refer to the Owner's Manual on the DVD for the complete maintenance schedule.



# MAINTAINING YOUR VEHICLE

## Maintenance Record

	Odometer	Date	Signature, Authorized Service Center
6,000 Miles (10,000 km) or 6 Months			
12,000 Miles (20,000 km) or 12 Months			
18,000 Miles (30,000 km) or 18 Months			
24,000 Miles (40,000 km) or 24 Months			
30,000 Miles (50,000 km) or 30 Months			
36,000 Miles (60,000 km) or 36 Months			
42,000 Miles (70,000 km) or 42 Months			
48,000 Miles (80,000 km) or 48 Months			
54,000 Miles (90,000 km) or 54 Months			
60,000 Miles (100,000 km) or 60 Months			
66,000 Miles (110,000 km) or 66 Months			
72,000 Miles (120,000 km) or 72 Months			
78,000 Miles (130,000 km) or 78 Months			



# MAINTAINING YOUR VEHICLE

## FUSES

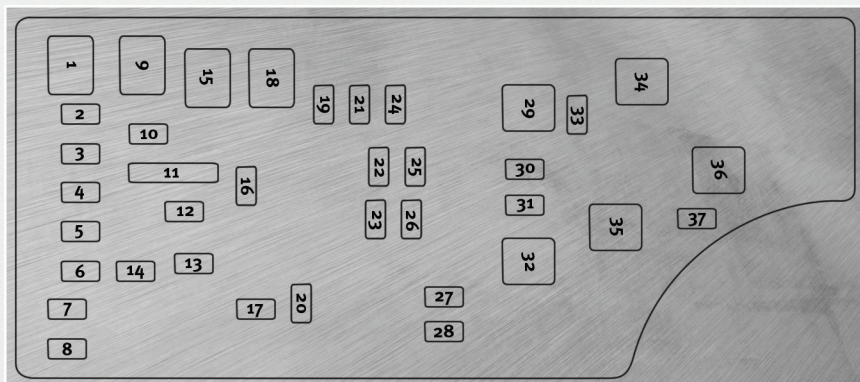

### Totally Integrated Power Module (TIPM)

- The Totally Integrated Power Module (TIPM) is located in the engine compartment near the air cleaner assembly. This center contains cartridge fuses and mini fuses.

Cavity	Cartridge Fuse	Mini Fuse	Description
1	40 Amp Green		Power Top Module (If Equipped)
2		20 Amp Yellow	AWD Module
3		10 Amp Red	Battery Feed — Center High Mounted Stop Light (CHMSL)/Brake Switch
4		10 Amp Red	Battery Feed — Ignition Switch
5		20 Amp Yellow	Trailer Tow — If Equipped
6		10 Amp Red	Ignition Off Draw (IOD) — Power Mirror Switch/Climate Controls
7		30 Amp Green	Ignition Off Draw (IOD) Sense 1
8		30 Amp Green	Ignition Off Draw (IOD) Sense 2
9	40 Amp Green		Battery Feed — Power Seats - if equipped/PZEV Air Pump - if equipped
10		20 Amp Yellow	Battery Feed — Cabin Compartment Node (CCN)
11		15 Amp Lt. Blue	Selectable Power Outlet
12		20 Amp Yellow	—
13		20 Amp Yellow	—
14		10 Amp Red	Ignition Off Draw (IOD) — Cabin Compartment Node (CCN)/ Interior Lighting
15	40 Amp Green		Battery Feed — Radiator Fan Relay
16		15 Amp Lt. Blue	IGN Run/ACC — Cigar Lighter/PWR Sunroof Mod



# MAINTAINING YOUR VEHICLE

Cavity	Cartridge Fuse	Mini Fuse	Description
17		10 Amp Red	Ignition Off Draw (IOD) — Wireless Control Module (WCM)/Clock/Steering Control Module (SCM)
18	40 Amp Green		Battery Feed — Auto Shutdown (ASD) Relay
19		20 Amp Yellow	Ignition Off Draw (IOD) — Power Amp Feed 2 - if equipped
20		15 Amp Lt. Blue	Ignition Off Draw (IOD) — Radio
21		10 Amp Red	—
22		10 Amp Red	Ignition Run — Climate Controls/Hot Cupholder - if equipped
23		15 Amp Lt. Blue	Auto Shutdown (ASD) Relay Feed 3
24		25 Amp Natural	Battery Feed — PWR Sunroof Feed
25		10 Amp Red	Ignition Run — Heated Mirrors - If Equipped
26		15 Amp Lt. Blue	Auto Shutdown (ASD) Relay Feed 2
27		10 Amp Red	Ignition Run — Occupant Classification Module (OCM)/Occupant Restraint Controller (ORC)
28		10 Amp Red	Ignition Run — Occupant Classification Module (OCM)/Occupant Restraint Controller (ORC)
29	—	—	Hot Car (No Fuse Required)
30		20 Amp Yellow	Ignition Run — Heated Seats - If Equipped
31		10 Amp Red	—
32	30 Amp Pink		Auto Shutdown (ASD) Relay Feed 1
33		10 Amp Red	Battery Feed — Switch Bank/Diagnostic Link Connector/Powertrain Control Module (PCM)
34	30 Amp Pink		Battery Feed — Anti-Lock Brakes (ABS) Module - if equipped/Electronic Stability Program (ESC) Module - If Equipped
35	40 Amp Green		Battery Feed — Anti-Lock Brakes (ABS) Module - If Equipped/Electronic Stability Program (ESC) Module - If Equipped
36	30 Amp Pink		Battery Feed — Passenger Door Module (PDM)/Driver Door Module (DDM)
37		25 Amp Natural	Power Top Module (If Equipped)



# MAINTAINING YOUR VEHICLE

## TIRE PRESSURES

- Check the inflation pressure of each tire, including the spare tire, at least monthly and inflate to the recommended pressure for your vehicle.
- The tire pressures recommended for your vehicle are found on the “Tire and Loading Information” label located on the driver’s side door opening.

**NOTE:** Refer to the Owner’s Manual on the DVD for more information on the life of tires.

### WARNING!

Overloading of your tires is dangerous. Overloading can cause tire failure, affect vehicle handling, and increase your stopping distance. Use tires of the recommended load capacity for your vehicle. Never overload them.

### WARNING!

Improperly inflated tires are dangerous and can cause accidents. Under-inflation is the leading cause of tire failure and may result in severe cracking, component separation, or “blow out”. Over-inflation reduces a tire’s ability to cushion shock. Objects on the road and chuck holes can cause damage that results in tire failure. Unequal tire pressures can cause steering problems. You could lose control of your vehicle. Over-inflated or under-inflated tires can affect vehicle handling and can fail suddenly, resulting in loss of vehicle control.

## WHEEL AND WHEEL TRIM CARE

- All wheels and wheel trim, especially aluminum and chrome plated wheels, should be cleaned regularly with a mild soap and water to prevent corrosion.
- To remove heavy soil and/or excessive brake dust, use MOPAR® Wheel Cleaner or equivalent or select a non-abrasive, non-acidic cleaner.

### CAUTION!

Do not use scouring pads, steel wool, a bristle brush, or metal polishes. Do not use oven cleaner. These products may damage the wheel’s protective finish. Avoid automatic car washes that use acidic solutions or harsh brushes that may damage the wheel’s protective finish. Only MOPAR® Wheel Cleaner or equivalent is recommended.



# MAINTAINING YOUR VEHICLE

## EXTERIOR BULBS

<b>LIGHT BULBS – Exterior</b>	<b>Bulb Number</b>
Backup, Tail, Stop, Turn Lamp	3157
Center High-Mounted Stop Lamp (CHMSL)	W16W (921)
Fog Lamp – If Equipped	PSX24W
Front Park/Turn Signal	3757A
Front Side Marker	3757A
Front Position Lamp	W5W
Headlamp – Low Beam	H11
Headlamp – High Beam	9005
License Lamp	W5W



# CONSUMER ASSISTANCE

## CHRYSLER GROUP LLC CUSTOMER CENTER

P.O. Box 21-8004

Auburn Hills, MI 48321-8004

Phone: 1-800-423-6343

## CHRYSLER CANADA INC. CUSTOMER CENTER

P.O. Box 1621

Windsor, Ontario N9A 4H6

Phone: 1-800-465-2001

## ASSISTANCE FOR THE HEARING IMPAIRED

- To assist customers who have hearing difficulties, the manufacturer has installed special TDD (Telecommunication Devices for the Deaf) equipment at its customer center. Any hearing or speech impaired customer, who has access to a TDD or a conventional teletypewriter (TTY) in the United States, can communicate with the manufacturer by dialing 1-800-380-CHRY. Canadian residents with hearing difficulties that require assistance can use the special needs relay service offered by Bell Canada. For TTY teletypewriter users, dial 711 and for Voice callers, dial 1-800-855-0511 to connect with a Bell Relay Service operator.

### WARNING!

Engine exhaust, some of its constituents, and certain vehicle components contain, or emit, chemicals known to the State of California to cause cancer and birth defects, or other reproductive harm. In addition, certain fluids contained in vehicles and certain products of component wear contain, or emit, chemicals known to the State of California to cause cancer and birth defects, or other reproductive harm.

## PUBLICATIONS ORDERING

- **If you are the first registered retail owner of your vehicle**, you may obtain one free printed copy of the Owner's Manual, Warranty Booklet or Radio Manuals on your DVD by calling 1-800-423-6343 (U.S.) or 1-800-387-1143 (Canada) or by contacting your dealer.
- Replacement User Guides or DVDs or, if you prefer, additional printed copies of the Owner's Manual, Warranty Booklet or Radio Manuals may be purchased by visiting [www.techauthority.com](http://www.techauthority.com) or by calling 1-800-890-4038 (U.S.) or 1-800-387-1143 (Canada). Visa, Master Card, American Express and Discover orders are accepted. If you prefer mailing your order, please call the above numbers for an order form.

**NOTE:** A street address is required when ordering manuals (no P.O. Boxes).



# CONSUMER ASSISTANCE

## NOTE:

- The Owner's Manual and User Guide electronic files are also available on the Chrysler, Jeep and Dodge websites.
- Click on the "For Owners" tab, select "Owner/Service Manuals", then select your desired model year and vehicle from the drop down lists.

## REPORTING SAFETY DEFECTS IN THE 50 UNITED STATES AND WASHINGTON, D.C.

- If you believe that your vehicle has a defect that could cause a crash or cause injury or death, you should immediately inform the National Highway Traffic Safety Administration (NHTSA) in addition to notifying the manufacturer.
- If NHTSA receives similar complaints, it may open an investigation, and if it finds that a safety defect exists in a group of vehicles, it may order a recall and remedy campaign. However, NHTSA cannot become involved in individual problems between you, your authorized dealer, and the manufacturer.
- To contact NHTSA, you may either call the Auto Safety Hotline toll free at 1-888-327-4236 (TTY: 1-800-424-9153), or go to <http://www.safercar.gov>; or write to: Administrator, NHTSA, 1200 New Jersey Avenue, SE., West Building, Washington, D.C. 20590. You can also obtain other information about motor vehicle safety from <http://www.safercar.gov>.

## In Canada

- If you believe that your vehicle has a safety defect, you should contact the Customer Service Department immediately. Canadian customers who wish to report a safety defect to the Canadian government should write to: Transport Canada, Motor Vehicle Defect Investigations and Recalls, 2780 Sheffield Road, Ottawa, Ontario K1B 3V9.

## TIRE WARRANTY

### Tire Limited Warranty And Adjustment Policy

- When a tire is removed from service due to a covered warranty condition under a tire manufacturer's "Limited Warranty Program", you may be eligible for a free tire replacement or a comparable new tire on a "prorated basis".
- Certain conditions, such as irregular wear or tire damage due to road hazards, collision, improper inflation, intentional alteration, and misuse, are excluded from the Limited Warranty Program. The Limited Warranty Program expires when your tires either wear to a specified tread depth, and/or after a period of time from the date of purchase, as stated in the Tire Warranty on the DVD.

**NOTE: Refer to the Tire Warranty on the DVD for specific information relating to the manufacturer's limited warranty for the tires installed on your vehicle. If you have any questions regarding the limited tire warranty coverage, contact your local authorized dealer or your local authorized tire dealer.**



# CONSUMER ASSISTANCE

## Disclaimer:

- THE TIRE MANUFACTURER'S LIMITED WARRANTY PROGRAM, THE DETAILS OF WHICH CAN BE FOUND ON THE OWNERS MANUAL DVD, THE TIRE MANUFACTURER'S WEBSITE OR AT ANY AUTHORIZED SERVICE CENTER ARE IN LIEU OF ALL OTHER REMEDIES OR WARRANTIES, EXPRESS OR IMPLIED, ARISING BY LAW OR OTHERWISE, INCLUDING FITNESS FOR A PARTICULAR PURPOSE OR MERCHANTABILITY. THE TIRE MANUFACTURER EXPRESSLY DISCLAIMS LIABILITY FOR INDIRECT, SPECIAL, INCIDENTAL OR CONSEQUENTIAL DAMAGES, LOST PROFIT, LOSS OF BUSINESS, LOSS OF GOODWILL, LOSS OF REPUTATION, PUNITIVE OR ANY OTHER DAMAGE, COST OR LOSS OF ANY KIND. SOME STATES AND PROVINCES DO NOT ALLOW THE EXCLUSION OR LIMITATION OF INCIDENTAL OR CONSEQUENTIAL DAMAGES, SO THE ABOVE LIMITATION OR EXCLUSION MAY NOT APPLY TO YOU.

## WARNING!

NOTE: Refer to the Owner's Manual on the DVD for complete warning information that could prevent accidents, injuries and even deaths.

## WARNING!

Death, serious injury and/or property damage may result from:

- Tire failure due to impact damage and/or improper maintenance.

(Continued)

## WARNING! (Continued)

- Tires should be inspected regularly by a qualified technician for signs of damage, such as punctures, impacts, under-inflation or overloading.
  - Progressive air loss may result from punctures, cuts, curbing, impacts or partial bead unseating.
- Some fitment causes for air loss are:
- Incomplete bead seating.
  - Bead tearing caused by a machine tool due to insufficient lubrication or improper adjustment.
  - Leaking valve core or rubber valve components (these should be replaced when problems are detected and whenever tires are replaced).
  - Tire failure due to improper repairs.
  - See Rubber Manufacturer's Association (RMA) established repair procedures at [www.rma.org](http://www.rma.org) for information on proper repair procedures. Never perform a temporary repair or use an inner tube as a substitute for a proper repair. Only qualified persons should repair tires.
  - Explosion of tire/rim assembly due to improper mounting.
  - Only specially trained persons should mount tires.
  - Failure to mount tires on approved rims.
  - Failure to deflate single or dual assemblies completely before demounting.



# CONSUMER ASSISTANCE

## Using Lift Kits

- Use of lift kits with some vehicle/tire combinations can cause instability or loss of control. When changing tire sizes, always consult an installer for optimum rim width and carefully check vehicle/tire clearances.

## Check Your Tires For Damage

- Frequent (at least monthly) inspection of your tires for signs of damage, uneven tread wear and their general condition is important for safety. Impacts, penetrations, cracks, knots, bulges or air loss always require tire removal and expert inspection.

## Tire Service Life

- The service life of a tire is dependent upon varying factors including, but not limited to, your driving style, tire pressure and distance driven.

## WARNING!

Tires and the spare tire should be replaced after six years, regardless of the remaining tread. Failure to follow this warning can result in sudden tire failure. You could lose control and have an accident resulting in serious injury or death.

- Keep dismantled tires in a cool, dry place with as little exposure to the light as possible.
- Protect tires from contact with oil, grease, and gasoline.

**NOTE:** All tire warranties are made by the tire manufacturer. Tires are not covered under your Chrysler New Vehicle Limited Warranty.



# MOPAR ACCESSORIES

## MOPAR® ACCESSORIES

- The following highlights just some of the authentic Dodge Accessories by MOPAR® that have been engineered to customize your Dodge Avenger.
- To see the full line of accessories, stop by your Dodge dealer or visit MOPAR.com.

### CHROME:

- 17-Inch Chrome Aluminum Wheels
- Exhaust Tips

### EXTERIOR:

- Side Window Air Deflectors
- Sunroof Air Deflector
- Front Air Deflector
- Hitch Receiver
- Rear Spoiler
- Molded Splash Guards

### INTERIOR:

- Premium Carpet Floor Mats
- Door Sill Guards
- Molded Cargo Tray
- Slush Mats
- Ambient Light Kit

### ELECTRONICS:

- Portable Navigation Systems
- Uconnect™ Web (WiFi)
- Uconnect™ Phone
- iPod® Adapter
- Media Center 430 (REN/RBZ Multimedia Radio)
- DVD Rear Seat Video™
- Kicker® Sound System
- Media Center 730 (RER Navigation Radio)
- Remote Start

### CARRIERS:

- Hitch-mount Bike Carrier
  - Roof Mount Bike Carrier
  - Roof Box Cargo Carrier
  - Roof Mount Ski and Snowboard Carrier
  - Roof Mount Water Sports Carrier
  - Roof Mount Canoe Carrier
- iPod® is a registered trademark of Apple, Inc.
- Kicker® is a registered trademark of Stillwater Designs and Audio, Inc.











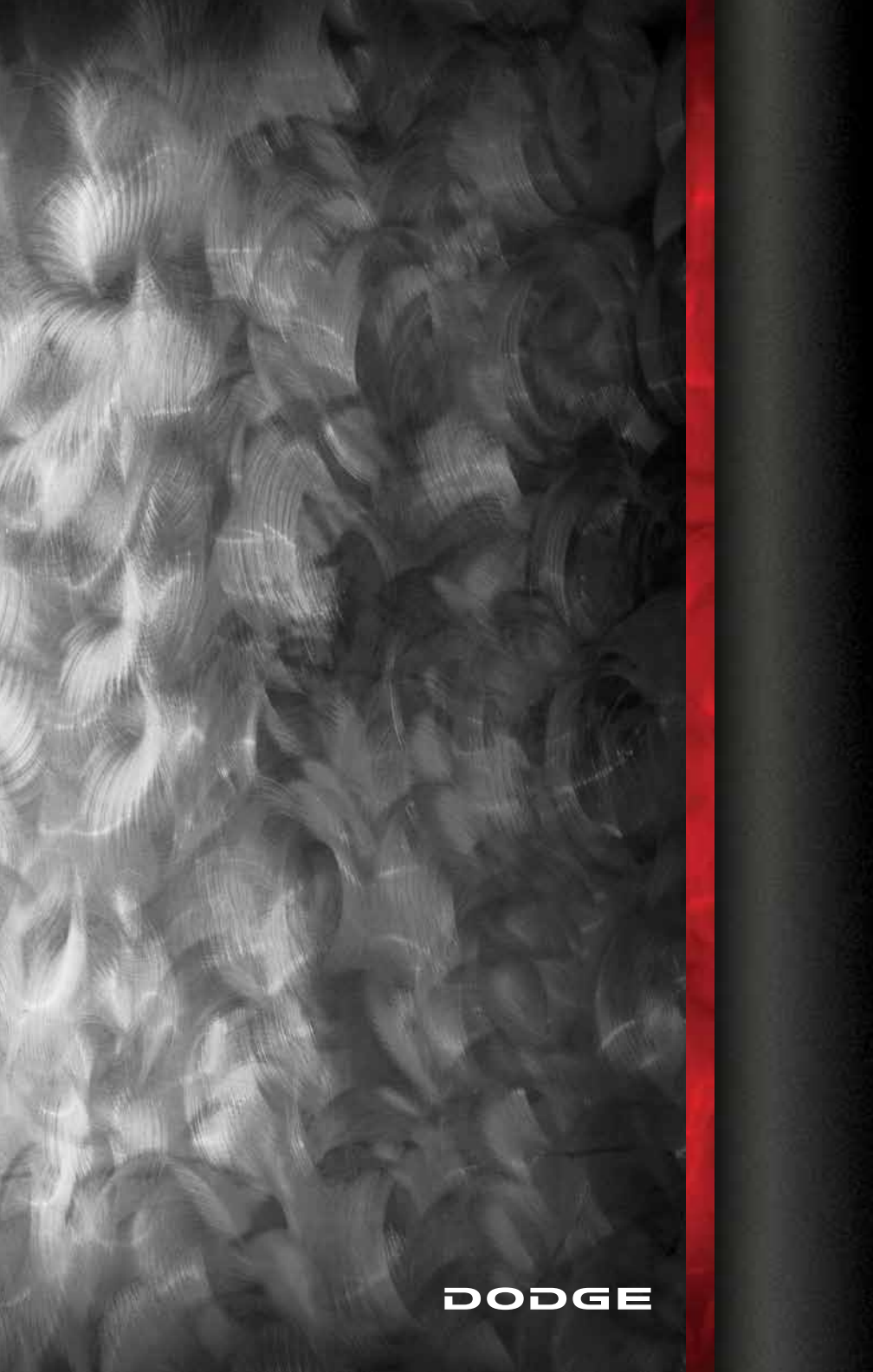

**DODGE**



# AVENGER

## DODGE.com

This guide has been prepared to help you get quickly acquainted with your new Dodge and to provide a convenient reference source for common questions. However, it is not a substitute for your Owner's Manual.

For complete operational instructions, maintenance procedures and important safety messages, please consult your Owner's Manual, Navigation/Media Center Manuals, Multimedia User Manual and other Warning Labels in your vehicle.

Not all features shown in this guide may apply to your vehicle. For additional information on accessories to help personalize your vehicle, visit [www.mopar.com](http://www.mopar.com) or your local Dodge dealer.



10D41-926-AA  
Avenger  
Third Printing  
User Guide