

**DODGE**



**NITRO**  
USER GUIDE **2010**



**IMPORTANT:** This User Guide is intended to familiarize you with the important features of your vehicle. The DVD enclosed contains your Owner's Manual, Navigation/Media Center Manuals, Warranty Booklets, Tire Warranty and 24-Hour Towing Assistance (new vehicles purchased in the U.S.) or Roadside Assistance (new vehicles purchased in Canada) in electronic format. We hope you find it useful. If you are the first registered owner of your vehicle, you may obtain a printed copy of the Owner's Manual, Navigation/Media Center Manuals or Warranty Booklet by calling 1-800-423-6343 (U.S.) or 1-800-387-1143 (Canada) or by contacting your dealer. Replacement DVD kits may be purchased by visiting [www.techauthority.com](http://www.techauthority.com).  
Copyright © 2010 Chrysler Group LLC.

# TABLE OF CONTENTS

## INTRODUCTION/WELCOME

WELCOME FROM CHRYSLER GROUP LLC . . . . .	2
--	---

## CONTROLS AT A GLANCE

DRIVER COCKPIT . . . . .	4
INSTRUMENT CLUSTER . . . . .	6

## GETTING STARTED

KEY FOB . . . . .	8
THEFT ALARM . . . . .	9
SEAT BELT . . . . .	9
CHILD RESTRAINTS . . . . .	9
FRONT SEATS . . . . .	11
REAR SEATS . . . . .	13
HEATED SEATS . . . . .	14
TILT STEERING COLUMN . . . . .	15
PROGRAMMABLE FEATURES . . . . .	15

## OPERATING YOUR VEHICLE

TURN SIGNAL/LIGHTS LEVER . . . . .	17
WIPER/WASHER LEVER . . . . .	18
SPEED CONTROL LEVER . . . . .	19
MANUAL CLIMATE CONTROLS . . . . .	20
AUTOMATIC TEMPERATURE CONTROLS (ATC) . . . . .	20
PARKSENSE® REAR PARK ASSIST . . . . .	21
POWER SUNROOF . . . . .	21
WIND BUFFETING . . . . .	22

## ELECTRONICS

NON-TOUCH-SCREEN RADIOS . . . . .	23
NAVIGATION TOUCH-SCREEN RADIO . . . . .	26
REMOTE AUDIO CONTROLS . . . . .	29
ELECTRONIC VEHICLE INFORMATION CENTER (EVIC) . . . . .	29
UNIVERSAL GARAGE DOOR OPENER . . . . .	30
POWER OUTLET . . . . .	31
UCONNECT™ PHONE . . . . .	31
VOICE COMMAND . . . . .	33

## OFF-ROAD CAPABILITIES

FOUR-WHEEL DRIVE OPERATION . . . . .	34
--------------------------------------	----

## UTILITY

CARGO AREA FEATURES . . . . .	35
TRAILER TOWING WEIGHTS (MAXIMUM TRAILER WEIGHT RATINGS) . . . . .	36
RECREATIONAL TOWING (BEHIND MOTORHOME, ETC.) . . . . .	37
BRAKE/TRANSMISSION INTERLOCK MANUAL OVERRIDE . . . . .	38

## WHAT TO DO IN EMERGENCIES

24-HOUR TOWING ASSISTANCE - U.S. ONLY . . . . .	39
INSTRUMENT CLUSTER WARNING LIGHTS . . . . .	39
IF YOUR ENGINE OVERHEATS . . . . .	42
JACKING AND TIRE CHANGING . . . . .	43
JUMP-STARTING . . . . .	46
TOWING A DISABLED VEHICLE . . . . .	49
EVENT DATA RECORDER (EDR) . . . . .	50

## MAINTAINING YOUR VEHICLE

OPENING THE HOOD . . . . .	51
ENGINE COMPARTMENT . . . . .	52
FLUIDS AND CAPACITIES . . . . .	54
MAINTENANCE CHART . . . . .	56
FUSES . . . . .	58
TIRE PRESSURES . . . . .	61
WHEEL AND WHEEL TRIM CARE . . . . .	62
EXTERIOR BULBS . . . . .	62

## CONSUMER ASSISTANCE

CHRYSLER GROUP LLC CUSTOMER CENTER . . . . .	63
CHRYSLER CANADA INC. CUSTOMER CENTER . . . . .	63
ASSISTANCE FOR THE HEARING IMPAIRED . . . . .	63
PUBLICATIONS ORDERING . . . . .	63
REPORTING SAFETY DEFECTS IN THE 50 UNITED STATES AND WASHINGTON, D.C. . . . .	64
TIRE WARRANTY . . . . .	64

## MOPAR ACCESSORIES

MOPAR® ACCESSORIES . . . . .	67
------------------------------	----

# INTRODUCTION/WELCOME

## WELCOME FROM CHRYSLER GROUP LLC

Congratulations on selecting your new Chrysler Group LLC vehicle. Be assured that it represents precision workmanship, distinctive styling, and high quality - all essentials that are traditional to our vehicles.

This guide illustrates and describes the operation of features and equipment that are either standard or optional on this vehicle. This guide may also include a description of features and equipment that are no longer available or were not ordered on this vehicle. Please disregard any features and equipment described in this guide that are not available on this vehicle. Chrysler Group LLC reserves the right to make changes in design and specifications and/or make additions to or improvements to its products without imposing any obligation upon itself to install them on products previously manufactured.

For complete owner information, refer to the DVD in the owner's kit provided at the time of new vehicle purchase. For your convenience, the information contained on the DVD may also be printed and saved for future reference.

Chrysler Group LLC is committed to protecting our environment and natural resources. By converting from paper to electronic delivery for the majority of the user information for your vehicle, together we greatly reduce the demand for tree-based products and lessen the stress on our environment.

### Vehicles Sold In Canada

With respect to any Vehicles sold in Canada, the name Chrysler Group LLC shall be deemed to be deleted and the name Chrysler Canada Inc. used in substitution therefore.

### Driving And Alcohol

Drunken driving is one of the most frequent causes of accidents.

Your driving ability can be seriously impaired with blood alcohol levels far below the legal minimum. If you are drinking, don't drive. Ride with a designated non-drinking driver, call a cab, a friend, or use public transportation.

#### **WARNING!**

Driving after drinking can lead to an accident. Your perceptions are less sharp, your reflexes are slower, and your judgment is impaired when you have been drinking. Never drink and then drive.

# INTRODUCTION/WELCOME

## Rollover Warning

<b>▲ WARNING: HIGHER ROLLOVER RISK</b>		
	<b>Avoid Abrupt Maneuvers and Excessive Speed.</b>  <b>Always Buckle Up.</b>  <b>See Owner's Manual For Further Information</b>	

### WARNING!

Never use the 'PARK' position as a substitute for the parking brake. Always apply the parking brake fully when parked to guard against vehicle movement and possible injury or damage.

### CAUTION!

Never park your vehicle over dry grass or other combustible materials. The heat from your vehicle exhaust system could cause a fire.

CHRYSLER, DODGE, JEEP, ATF+4, MOPAR and Uconnect are registered trademarks of Chrysler Group LLC.

**COPYRIGHT ©2010 CHRYSLER GROUP LLC**



# CONTROLS AT A GLANCE

## DRIVER COCKPIT



# CONTROLS AT A GLANCE



Power Outlet/  
Cigar Lighter

Audio System  
(non-touch-screen radio shown)

Climate Control

SWITCH PANEL  
Heated Seats\*  
Electronic Stability Program\*  
Power Inverter\*  
Hazard Switch  
Park Assist\*

Transmission Gear Selector

Transfer Case Switch

Park Brake Lever





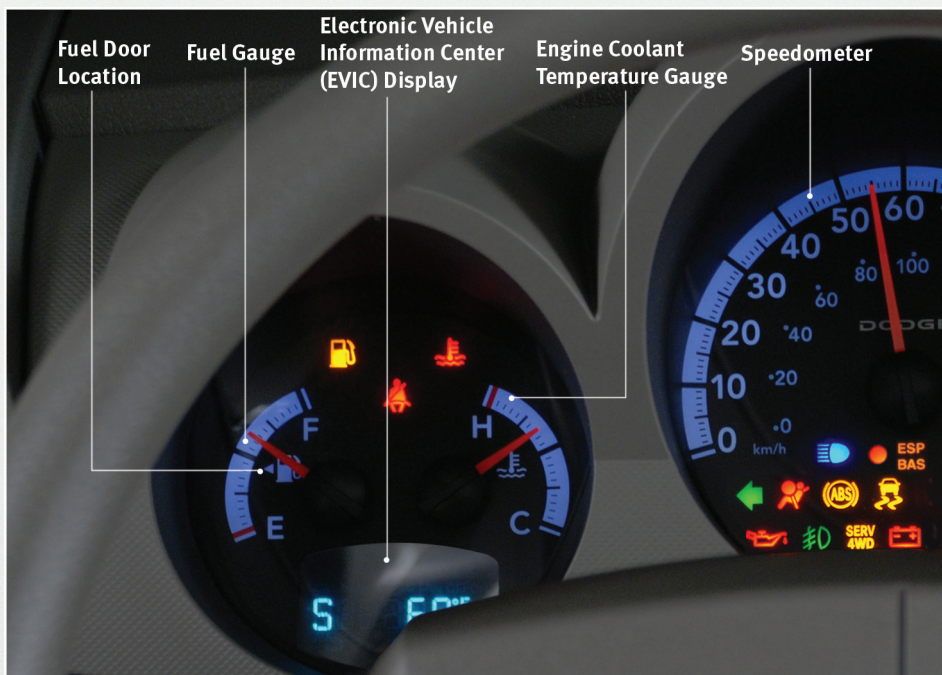





\*If Equipped

# CONTROLS AT A GLANCE





## INSTRUMENT CLUSTER

### Warning Lights

-  - Low Fuel Warning Light
-  - Charging System Light\*\*
-  - Oil Pressure Warning Light\*\*
-  - Anti-Lock Brake (ABS) Light\*\*
-  - Airbag Warning Light\*\*
-  - Electronic Throttle Control (ETC) Light
-  - Tire Pressure Monitoring System (TPMS) Light
-  - Engine Temperature Warning Light
-  - Transmission Temperature Warning Light
-  - Seat Belt Reminder Light

### BRAKE

-  - Brake Warning Light\*\*
-  - Electronic Stability Program (ESP) Indicator Light / Brake Assist System (BAS) Warning Light\*\*
-  - SERV (Service) 4WD Indicator Light











# CONTROLS AT A GLANCE



Tachometer

## Indicators

-  - Turn Signal Indicators
-  - High Beam Indicator
-  - Front Fog Light Indicator
-  - Vehicle Security Indicator\*
-  - TOW/HAUL Indicator
-  - 4WD LOW Indicator
-  - Electronic Stability Program (ESP) Indicator Light/Traction Control System (TCS) Indicator
-  - Cruise Indicator

## Odometer Messages

ECO - Fuel Saver Indicator Off  
ECO-ON - Fuel Saver Indicator On  
door - Door Ajar  
gASCAP - Fuel Cap Fault

LoWASH - Low Washer Fluid  
noFUSE\* - Fuse Fault  
CHAnGE OIL\* - Change Engine Oil

\* If equipped

\*\* Bulb Check with Key On

# GETTING STARTED

## KEY FOB



### Locking And Unlocking The Doors/Liftgate

- Press the LOCK button once to lock all the doors and the liftgate. Press the UNLOCK button once to unlock the driver's door only and twice within five seconds to unlock all the doors and liftgate.
- All doors can be programmed to unlock on the first press of the UNLOCK button. Refer to Programmable Features in this guide.

## WARNING!

Leaving unattended children in a vehicle is dangerous for a number of reasons. A child or others could be injured. Children should be warned not to touch the parking brake, brake pedal, or the shift lever. Do not leave the key in the ignition. A child could operate power windows, other controls, or move the vehicle.

### Remote Start

- Press the REMOTE START button  twice within five seconds. Pressing the REMOTE START button a third time shuts the engine off.
- To drive the vehicle, press the UNLOCK button, insert the key in the ignition and turn to the ON/RUN position.
- With remote start, the engine will only run for 15 minutes (timeout) unless the ignition key is placed in the ON/RUN position.
- The vehicle must be started with the key after two consecutive timeouts.

## WARNING!

- Do not start or run an engine in a closed garage or confined area. Exhaust gas contains Carbon Monoxide (CO) which is odorless and colorless. Carbon Monoxide is poisonous and can cause serious injury or death when inhaled.
- Keep Key Fob transmitters away from children. Operation of the Remote Start System, windows, door locks or other controls could cause serious injury or death.

# GETTING STARTED

## Panic Alarm

- Press the PANIC button once to turn the panic alarm on.
- Wait approximately three seconds and press the button a second time to turn the panic alarm off.

## Express Window Feature

- To remotely lower both front door windows at the same time, press and release the UNLOCK button and then immediately press and hold the UNLOCK button until the windows lower to the level desired or until they lower completely.

## THEFT ALARM

### To Arm

- Press the Key Fob LOCK button or the power door lock switch while the door is open.

### To Disarm

- Press the Key Fob UNLOCK button and turn the ignition to the ON position.

## SEAT BELT

- Be sure everyone in your vehicle is in a seat and using a seat belt properly.

### WARNING!

In a collision, you and your passengers can suffer much greater injuries if you are not properly buckled up. You can strike the interior of your vehicle or other passengers, or you can be thrown out of the vehicle. Always be sure you and others in your vehicle are buckled up properly.

## CHILD RESTRAINTS

- Children 12 years and under should ride properly buckled up in a rear seat, if available. According to crash statistics, children are safer when properly restrained in the rear seats rather than in the front.
- Every state in the United States and all Canadian provinces require that small children ride in proper restraint systems. This is the law, and you can be prosecuted for ignoring it.

### WARNING!

In a collision, an unrestrained child, even a tiny baby, can become a projectile inside the vehicle. The force required to hold even an infant on your lap could become so great that you could not hold the child, no matter how strong you are. The child and others could be badly injured. Any child riding in your vehicle should be in a proper restraint for the child's size.

# GETTING STARTED

## Installing The LATCH - Compatible Child Restraint System

- Your vehicle's second row passenger seats are equipped with the child restraint anchorage system called LATCH, which stands for Lower Anchors and Tether for CHildren.
- The rear outboard seating positions have lower anchors and all three rear seating positions have top tether anchors.
- Child seats with fixed lower attachments must be installed in the outboard positions only. Child seats with flexible lower attachments can be used in all three seating positions.
- **Never** install LATCH-compatible child seats such that two seats share a common lower anchorage.



- Loosen the adjusters on the lower straps and tether straps so that you can attach the hook or connector to the lower and tether anchorages more easily.
- Attach the lower hooks or connectors over the top of the anchorage bars, pushing aside the seat cover material. You will easily feel the anchorage bars if you run your finger along the intersection of the seatback and seat cushion surfaces.

- The tether strap should be attached to the tether anchor on the rear of the seatback using the most direct path. For the outboard seating positions, route the tether underneath the head rest and attach the hook to the tether anchor located on the back of the seat.

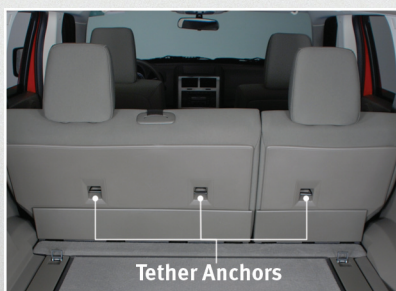

- Tighten all three straps as you push the child restraint rearward and downward into the seat.

# GETTING STARTED

## WARNING!

- Improper installation of a child restraint to the LATCH anchorages can lead to failure of an infant or child restraint. The child could be badly injured or killed. Follow the manufacturer's directions exactly when installing an infant or child restraint.
- An incorrectly anchored tether strap could lead to increased head motion and possible injury to the child. Use only the anchor positions directly behind the child seat to secure a child restraint top tether strap.

## Installing The Child Restraint Using The Vehicle Seat Belts

- To install a child restraint, first, pull enough of the seat belt webbing from the retractor to route it through the belt path of the child restraint and slide the latch plate into the buckle.
- Next, extract all the seat belt webbing out of the retractor and then allow the belt to retract into the retractor. Finally, pull on any excess webbing to tighten the lap portion around the child restraint. Any seat belt system will loosen with time, so check the belt occasionally, and pull it tight if necessary.
- Once you have completed securing the child restraint with the seat belt, secure the top tether strap. The tether strap should be attached to the tether anchor on the rear of the seatback using the most direct path. For the outboard seating positions, route the tether underneath the head rest and attach the hook to the tether anchor located on the back of the seat.

## WARNING!

Rearward-facing child seats must **NEVER** be used in the front seat of a vehicle with a front passenger airbag. An airbag deployment could cause severe injury or death to infants in this position.

## FRONT SEATS

## WARNING!

Adjusting a seat while the vehicle is moving is dangerous. The sudden movement of the seat could cause you to lose control. The seat belt might not be properly adjusted, and you could be injured. Only adjust a seat while the vehicle is parked.

# GETTING STARTED

## Manual Seat Adjustment

### Forward/Rearward



- Lift up on the adjusting bar located at the front of the seat near the floor and release at the desired position.

### Recliner



- Lift the recliner lever located on the outboard side of the seat, lean back and release at the desired position.

## WARNING!

Do not ride with the seatback reclined so that the seat belt is no longer resting against your chest. In a collision, you could slide under the seat belt and be seriously or even fatally injured. Use the recliner only when the vehicle is parked.

## Six-Way Driver's Power Seat with Manual Recliner



- The power seat switch, located on the outboard side of the seat near the floor, controls forward/back, up/down, and tilt adjustment.
- This seat also has a manual recline lever located just to the rear of the power seat switch. Lift the recliner lever, lean back and release at the desired position.

# GETTING STARTED

## CAUTION!

DO NOT place any article under a power seat or impede its ability to move as it may cause damage to the seat controls. Seat travel may become limited if movement is stopped by an obstruction in the seat's path.

### Fold-Flat Front Passenger Seat



- The front passenger seat can be folded flat to allow for extended cargo space. Pull up on the recliner lever to fold down the seatback.

## REAR SEATS

### 60/40 Split Folding Rear Seat With Fold-Flat Feature

- Each rear seatback can be folded flat or reclined.

#### To Lower Rear Seatback

- With the front seats fully upright and positioned forward, pull the release strap toward the front of the vehicle and fold the rear seatback completely forward.
- Push down on the seatback to lock it in the folded position.



#### To Raise Rear Seatback

- Pull the release strap (toward the front of the vehicle).
- Raise the seatback and lock it into place.

# GETTING STARTED

## WARNING!

Be certain that the seatback is securely locked into position. If the seatback is not securely locked into position, the seat will not provide the proper stability for child seats and/or passengers. An improperly latched seat could cause serious injury.

### Recliner Adjustment

- Pull the release strap while sitting in the rear seat to recline the seatback.

## HEATED SEATS

### Front Heated Seats



- The controls for front heated seats are located near the bottom center of the instrument panel (below the heater/air conditioning controls).
- Press the switch once to select High-level heating. Press the switch a second time to select Low-level heating. Press the switch a third time to shut the heating elements Off.

## WARNING!

- Persons who are unable to feel pain to the skin because of advanced age, chronic illness, diabetes, spinal cord injury, medication, alcohol use, exhaustion or other physical conditions must exercise care when using the seat heater. It may cause burns even at low temperatures, especially if used for long periods of time.
- Do not place anything on the seat that insulates against heat, such as a blanket or cushion. This may cause the seat heater to overheat. Sitting in a seat that has been overheated could cause serious burns due to the increased surface temperature of the seat.

## CAUTION!

Repeated overheating of the seat could damage the heating element and/or degrade the material of the seat.



# GETTING STARTED

## TILT STEERING COLUMN





- The tilt lever is located on the steering column, below the turn signal lever.
- Push down on the lever to unlock the steering column.
- With one hand firmly on the steering wheel, move the steering column up or down as desired.
- Pull upward on the lever to lock the column firmly in place.

### WARNING!

Tilting the steering column while the vehicle is moving is dangerous. Without a stable steering column, you could lose control of the vehicle and have an accident. Adjust the column only while the vehicle is stopped. Be sure it is locked before driving.

## PROGRAMMABLE FEATURES

### Electronic Vehicle Information Center (EVIC) – If Equipped

- The EVIC can be used to program the following Personal Settings. Press and release the MENU button  until Personal Settings displays, then press the SCROLL button  to scroll through the settings. Press the FUNCTION SELECT button  to change the setting.
  - Language
  - Auto Door Locks
  - Auto UNLK On Exit
  - RKE Unlock
  - Sound Horn With RKE Lock
  - Turn Headlamps On With Remote Key Unlock
  - Flash Lamp Lock
  - Headlamp Off Delay
  - Key-Off Power Delay
  - Display ECO
  - Display Units of Measure In

### Key Fob Programmable Features

- The following features may also be programmed by using the Key Fob transmitter or the ignition switch and driver's door lock switch.

**NOTE:** Pressing the LOCK button while you are inside the vehicle will activate the Vehicle Security Alarm. Opening a door with the Vehicle Security Alarm activated will cause the alarm to sound. Press the UNLOCK button to deactivate the Vehicle Security Alarm.

# GETTING STARTED

## Unlock On First Press

- To unlock either the driver's side, or all doors, on the first press of the UNLOCK button:
  - Press and hold the LOCK button for at least 4 seconds, but no longer than 10 seconds. Then, press and hold the UNLOCK button while still holding the LOCK button.
  - Release both buttons at the same time.

## Auto Unlock Doors On Exit

- To have all of the vehicle doors unlock when any door is opened:
  - Enter your vehicle and close all the doors.
  - Cycle the ignition switch between LOCK and ON and then back to LOCK four times, ending up in the LOCK position (do not start the engine).
  - Press the power door UNLOCK switch to unlock the doors. A single chime will indicate that programming is complete.

## Auto Door Lock

- To have the doors lock automatically when the vehicle's speed exceeds 15 mph (24 km/h):
  - Enter your vehicle and close all the doors.
  - Cycle the ignition switch between LOCK and ON and then back to LOCK four times, ending up in the LOCK position (do not start the engine).
  - Press the power door LOCK switch to lock the doors. A single chime will indicate that programming is complete.

## Sound Horn With Lock

- To turn the horn chirp on or off when the doors are locked:
  - Press the LOCK button for at least 4 seconds, but no longer than 10 seconds. Then, press the PANIC button while still holding the LOCK button.
  - Release both buttons at the same time.

## Flashing Lights With Lock



- The turn signal lights flashing, when the doors are locked or unlocked, feature can be turned on or off. To turn this feature on or off:
  - Press and hold the UNLOCK button for at least 4 seconds, but no longer than 10 seconds. Then, press and hold the LOCK button while still holding the UNLOCK button.
  - Release both buttons at the same time.

# OPERATING YOUR VEHICLE

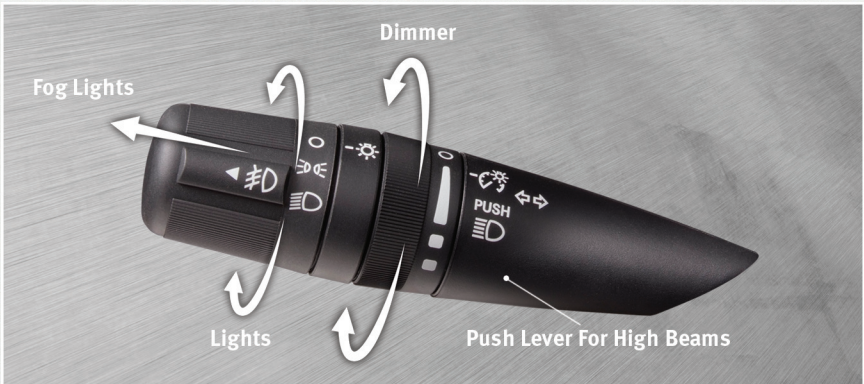
## TURN SIGNAL/LIGHTS LEVER



### Headlights/Parking Lights

- Rotate the end of the lever to the first detent for parking lights  and to the second detent for headlights .

### Instrument Panel Dimmer

- Rotate the center portion of the lever to the extreme bottom position to fully dim the instrument panel lights and prevent the interior lights from illuminating when a door is opened.
- Rotate the center portion of the lever up to increase the brightness of the instrument panel lights when the parking lights or headlights are on.
- Rotate the center portion of the lever upward to the next detent position to brighten the odometer and radio controls when the parking lights or headlights are on.
- Rotate the center portion of the lever upward to the last detent to turn on the interior lighting.

### Flash To Pass

- Pull the lever toward you to activate the high beams. The high beams will remain on until the lever is released.

### High Beam Operation

- Push the lever forward to activate the high beams.

**NOTE:** For safe driving, turn off high beams when oncoming traffic is present to prevent headlight glare and as a courtesy to other motorists.

### Fog Lights

- Turn on the parking lights or low beam headlights and pull out the end of the lever.

# OPERATING YOUR VEHICLE

## Turn Signals/Lane Change Assist

- Tap the lever up or down once and the turn signal (right or left) will flash three times and automatically turn off.

## WIPER/WASHER LEVER



## Front Wipers

### Intermittent, Low And High Operation

- Rotate the end of the lever to the first detent position for one of five intermittent settings, the second detent for low wiper operation and the third detent for high wiper operation.

### Washer Operation

- Pull the lever toward you and hold for as long as spray is desired.

### Mist

- Pull down on the lever and release when a single wipe is desired.

## Rear Wiper

### Wiper Operation

- Rotate the center portion of the lever forward to the first detent for rear wiper operation.

### Washer Operation

- Rotate the center portion of the lever past the first detent to activate the rear washer.

# OPERATING YOUR VEHICLE

## SPEED CONTROL LEVER



### Cruise ON/OFF

- Push the ON/OFF button to activate the Speed Control.
- CRUISE will appear on the instrument cluster to indicate the Speed Control is on.
- Push the ON/OFF button a second time to turn the system off.

## WARNING!

Leaving the Electronic Speed Control system on when not in use is dangerous. You could accidentally set the system or cause it to go faster than you want. You could lose control and have an accident. Always leave the Electronic Speed Control system off when you are not using it.

### Set

- With Speed Control on, push down and release the lever to set a desired speed.

## WARNING!

Electronic Speed Control can be dangerous where the system cannot maintain a constant speed. Your vehicle could go too fast for the conditions, and you could lose control. An accident could be the result. Do not use Electronic Speed Control in heavy traffic or on roads that are winding, icy, snow-covered or slippery.

### Accel/Decel

- Push and hold the lever up to accelerate or down to decelerate the vehicle; release the lever to save the new set speed.
- Once a speed is set, tapping the lever up or down will increase or decrease the set speed approximately 1 mph (2 km/h).

### Cancel

- Pull the lever toward you or apply the brakes to cancel the set speed and maintain the set speed in memory.
- Push the ON/OFF button to turn the system off and erase the set speed memory.

### Resume

- To resume a previously selected speed in memory, push the lever up and release.

# OPERATING YOUR VEHICLE

## MANUAL CLIMATE CONTROLS

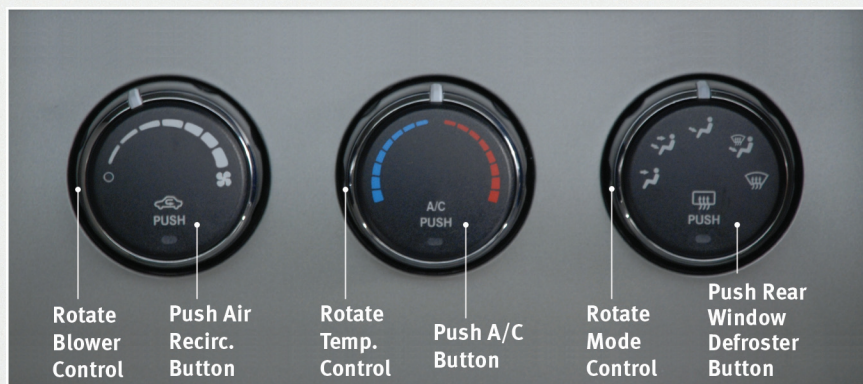

### Air Recirculation

- Use recirculation for maximum A/C operation.
- For window defogging, turn the recirculation button off.
- Recirculation is not allowed in defrost, floor, defrost/floor (mix) modes.

## AUTOMATIC TEMPERATURE CONTROLS (ATC)

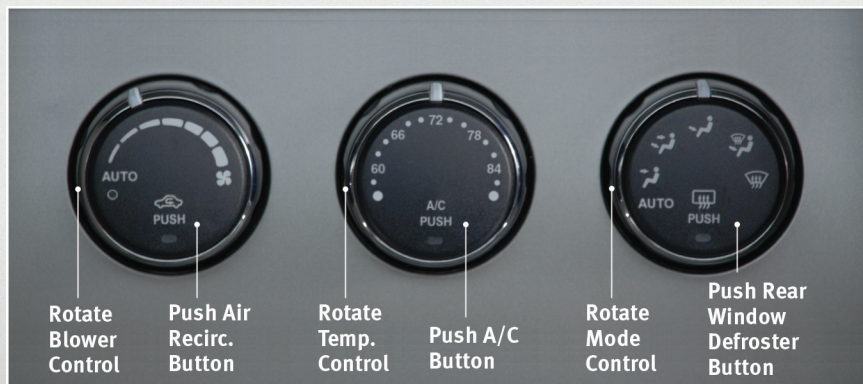

### Automatic Operation

- Turn the Mode and Blower Controls to the AUTO position.
- Select the desired temperature by rotating the Temperature Control.
- The system will maintain the set temperature automatically.

# OPERATING YOUR VEHICLE

## Air Conditioning (A/C)

- If the air conditioning button is pressed while in the AUTO mode, the indicator light may flash three times to indicate the cabin air is being controlled automatically.

## Air Recirculation

- Use recirculation for maximum A/C operation.
- For window defogging, turn the air recirculation button off.
- If the recirculation button is pressed while in the AUTO mode, the indicator light may flash three times to indicate the cabin air is being controlled automatically.

## PARKSENSE® REAR PARK ASSIST

- If an object is detected behind the rear bumper while the vehicle is in REVERSE, a warning will display in the instrument cluster and a chime will sound. The chime rate will change depending on the distance of the object, getting faster as the object gets closer to the bumper.

## POWER SUNROOF

- The power sunroof switch is located on the overhead console.

### WARNING!

- Never leave children in a vehicle with the key in the ignition switch. Occupants, particularly unattended children, can become entrapped by the power sunroof while operating the power sunroof switch. Such entrapment may result in serious injury or death.
- In an accident, there is a greater risk of being thrown from a vehicle with an open sunroof. You could also be seriously injured or killed. Always fasten your seat belt properly and make sure all passengers are properly secured too.
- Do not allow small children to operate the sunroof. Never allow your fingers, other body parts, or any object to project through the sunroof opening. Injury may result.

## Opening Sunroof

### Express

- Press the switch rearward and release. The sunroof will fully open and stop automatically.

## Closing Sunroof

### Express

- Press the switch forward and release. The sunroof will close automatically from any position.

# OPERATING YOUR VEHICLE

## Manual Open/Close

- Press and hold the switch rearward to open or forward to close the sunroof. Any release of the switch will stop the movement, and the sunroof will remain in a partially open or closed position until the switch is pressed again.

## Venting Sunroof

- Press and release the "VENT" button, and the sunroof will open to the vent position. This is called "Express Vent" and will occur regardless of sunroof position. During Express Vent operation, any movement of the switch will stop the sunroof.

## Pinch Protection Feature

- This feature will detect an obstruction in the opening of the sunroof during Express Close operation. If an obstruction in the path of the sunroof is detected, the sunroof will automatically return to the open position.

**NOTE:** Pinch protection is disabled while the switch is pressed and held during manual opening and closing of the sunroof.

## WIND BUFFETING

- Wind buffeting can be described as a helicopter-type percussion sound. If buffeting occurs with the rear windows open, adjust the front and rear windows together.
- If buffeting occurs with the sunroof open, adjust the sunroof opening, or adjust any window. This will minimize buffeting.



## NON-TOUCH-SCREEN RADIOS

### Media Center 130 (RES)



### Media Center 130 (RES/RSC)

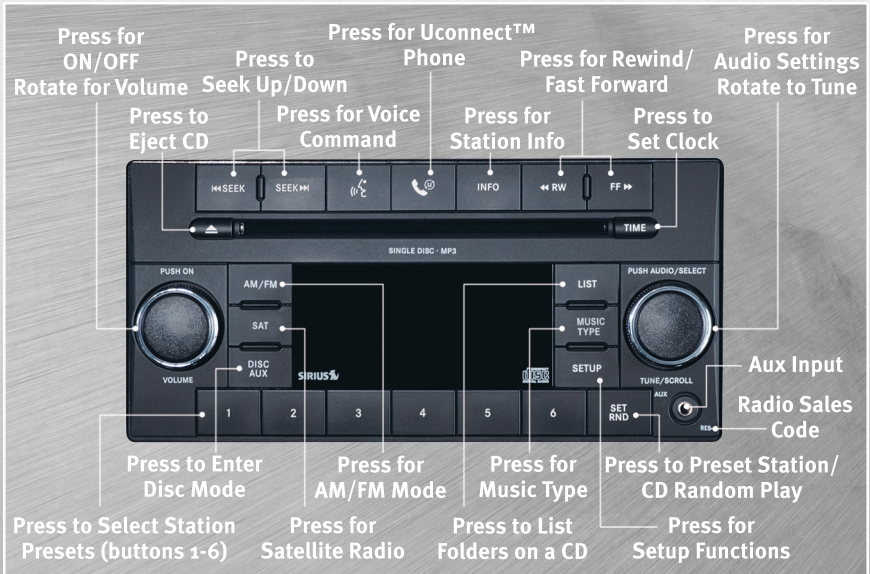

# ELECTRONICS

## Media Center 230 (REQ)



**NOTE:** Uconnect™ Phone and Voice Command are vehicle options which must be ordered separately. The buttons on the radio will only be active if the vehicle has been equipped with the option.

- The radio sales code is located on the lower right side of the radio faceplate.
- Unless otherwise noted, the information provided on the operation and functionality of the radios in this section is common to all non-touch-screen radios.

### Seek Up/Down Buttons

- Press to seek through radio stations in AM, FM or SAT bands. Seek through tracks in CD.
- Holding either button will bypass stations without stopping.

### Audio Settings

- Press the TUNE/SCROLL control knob and BASS, MID, TREBLE, BALANCE and FADE will display. Rotate the TUNE/SCROLL control knob to select the desired setting.

## Auxiliary Mode

- The auxiliary (AUX) jack allows a portable device, such as an MP3 player or a cassette player, to be plugged into the radio and utilize the vehicle's audio system to amplify the source and play through the vehicle speakers.
- Pressing the AUX button will change the mode to auxiliary device if the AUX jack is connected.
- The control of the external device cannot be provided by the radio; use the device controls instead.

## Clock Setting

- Press and hold the TIME button until the hours blink; turn the TUNE/SCROLL control knob to set the hours.
- Press the TUNE/SCROLL control knob until the minutes begin to blink; turn the TUNE/SCROLL control knob to set the minutes.
- Press the TUNE/SCROLL control knob to save the time change.
- To exit, press any button/knob or wait five seconds.

## Station Presets

- Press the SET/RND button once and SET 1 will show in the display. Then select the button (1–6).
- A second station may be added to each push button. Press the SET/RND button twice and SET 2 will show in the display, then select button (1–6).

## How To Load Multiple CDs/DVDs

### REQ Radio Only

- Press the LOAD button and then press the button with the corresponding number (1–6) where the CD is being loaded. The radio will display PLEASE WAIT and prompt when to INSERT DISC.
- After the radio displays INSERT DISC, insert the CD into the player. The radio display will show LOADING DISC when the disc is loading and "READING DISC" when the radio is reading the disc.
- Press the eject button and then the corresponding number (1–6) to eject the desired disc.

# ELECTRONICS

## NAVIGATION TOUCH-SCREEN RADIO

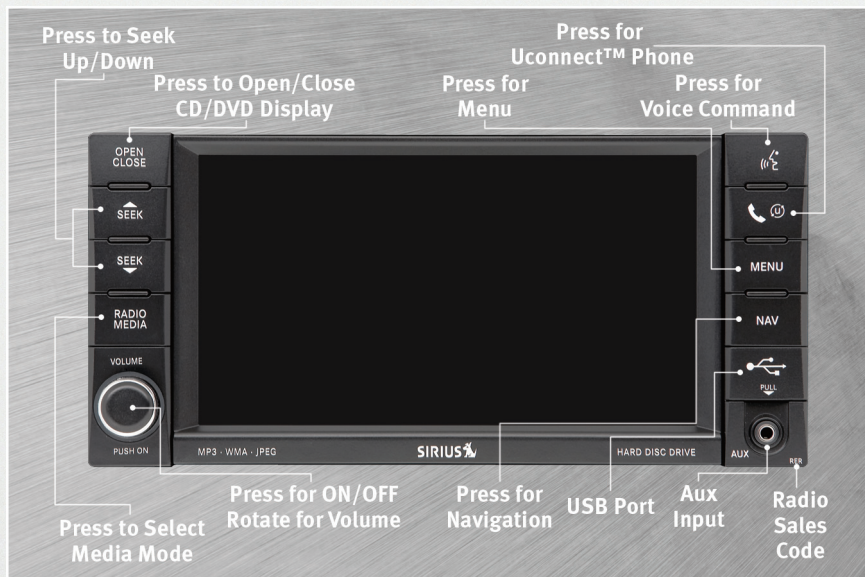

**NOTE:** Uconnect™ Phone and Voice Command are vehicle options which must be ordered separately. The buttons on the radio will only be active if the vehicle has been equipped with the option.

- The radio sales code is located on the lower right side of the radio faceplate.
- This navigation radio requires digital data from a navigation database. The data in the navigation database is licensed from Navigation Technologies®. Not all roads are digitized.
- For software updates, visit <http://www.chrysler.com/en/owners/mygig/> website, visit <http://www.navteq.com> website, or contact your authorized dealer for the latest available software.

### Seek Up/Down

- Press to seek through radio stations in AM, FM, or SAT bands. Seek through tracks in CD or iPod® modes or through songs in the HDD playlist.

### Radio Mode

- Press the RADIO/MEDIA hard-key to display the different radio modes, then press desired soft-key to select AM, FM, SAT, HDD or AUX.

### Auxiliary Mode

- The auxiliary (AUX) jack allows a portable device, such as an MP3 player or a cassette player, to be plugged into the radio and utilize the vehicle's audio system and play through the vehicle speakers.

## Clock Setting

### Manually Adjust Time

- Turn the radio on, then touch the screen where the time is displayed.
- Touch the USER CLOCK soft-key.
- To adjust the hours, touch either the HOUR FORWARD or HOUR BACKWARD soft-key.
- To adjust the minutes, touch either the MINUTE FORWARD or MINUTE BACKWARD soft-key.
- To save the new time setting, touch the screen where the word “Save” is displayed.

### Store Radio Presets

- Press the RADIO/MEDIA hard-key repeatedly until AM FM SAT is displayed in the upper left corner of the screen.
- Select the radio band by touching either the AM, FM, or SAT soft-key.
- Find the station to store by either pressing the SEEK UP/DOWN hard-key, or touch the SCAN soft-key, DIRECT TUNE soft-key or the left and right arrows.
- Once the station is found, touch and hold one of the PRESET soft-keys in the list to the right until you hear a confirmation beep.

## Hard Disc Drive Operation

### Copy Complete Audio Disc To Hard-Drive

- Press the OPEN/CLOSE hard-key and insert a disc, then press the MENU hard-key.
- Touch the MY FILES soft-key then select MY MUSIC.
- Touch the IMPORT MUSIC FILES soft-key then touch the FROM DISC soft-key.

### Copying From USB

- Insert a USB device then select MY MUSIC.
- Touch the IMPORT MUSIC FILES soft-key, then touch the FROM USB soft-key in the next screen.
- Select the folders or titles you would like to copy, then touch the DONE soft-key to start the copy process.

### Copy Pictures To The Hard-Drive

- Insert either a CD or a USB device containing your pictures.
- Touch the MY PICTURES soft-key to get an overview of the currently stored images.
- Press one of the ADD PICTURES soft-keys, then select the type of media inserted.
- Use the PAGE soft-keys to page through a list of pictures and press the picture you would like to import.
- Confirm your selection by touching the YES soft-key. The imported picture is now available in the MANAGE MY PICTURES screen.
- In order to display the imported picture in the radio screen, touch the desired picture soft-key.
- Select this picture by pressing the PICTURE VIEW soft-key. A check mark indicates the currently used picture.

# ELECTRONICS

## Cleaning Your Touch-Screen Radio

- Do not spray any liquid or caustic chemicals directly on the screen. Use a clean and dry micro fiber lens cleaning cloth in order to clean the touch-screen.
- If necessary, use a lint-free cloth dampened with a cleaning solution such as isopropyl alcohol or an isopropyl alcohol and water solution ratio of 50:50. Be sure to follow the solvent manufacturer's precautions and directions.

## Navigation

**NOTE:** Many features of this radio are speed dependent. For your own safety, it is not possible to use the touch-screen keyboard to enter a name (e.g., street name) while the vehicle is in motion. Pull over at a safe location to complete your task.

- The Navigation system receives GPS signals from satellites to display the position of your vehicle.

## New Destination

- Press the NAV hard-key to access the Navigation Main Menu.
- Touch the NEW DESTINATION soft-key to program a destination, then select the destination soft-key of your choice.

## Program/Storing Home Address

- Press the NAV hard-key to access the Navigation Main Menu.
- Touch the GUIDE ME HOME soft-key, then touch the STREET ADDRESS soft-key.
- Touch the STATE soft-key, then enter your state name into the speller; select your state from the list and press the CHANGE soft-key.
- Touch the INPUT STREET NAME soft-key and enter your street name into the speller.
- Touch the CONTINUE soft-key and enter your address into the speller; touch the CONTINUE soft-key again.
- Touch the city name and touch the SAVE soft-key to complete programming.

## Change Stored Home Address

- Press the MENU hard-key, then touch the MY FILES soft-key.
- Touch the MY ADDRESS BOOK soft-key, then touch the HOME soft-key.
- In the Home Address Information screen touch the EDIT CONTACT soft-key, then touch the CHANGE ADDRESS soft-key in the next screen.
- Touch the INPUT STREET NAME soft-key and enter your street name into the speller.
- Touch the CONTINUE soft-key and enter your address into the speller; touch the CONTINUE soft-key again.
- Touch the city name and touch the SAVE soft-key to complete programming.

## Guide Me Home

- Press the NAV hard-key to access the Navigation Main Menu.
- Touch the GUIDE ME HOME soft-key to route you back to your home destination from your current location. Touch the GO soft-key to start your trip.

## Map

- Press the NAV hard-key to access the Navigation Main Menu.
- Touch the MAP soft-key to display a map of your current position.

## REMOTE AUDIO CONTROLS



- The remote audio controls are located on the rear surface of the steering wheel.

### Right Switch

- Press the switch up or down to increase or decrease the volume.
- Press the button in the center to change modes AM/FM/CD/SAT.



### Left Switch

- Press the switch up or down to search for the next listenable station or select the next or previous CD track.
- Press the button in the center to select the next preset station (radio) or to change CDs if equipped with a CD Changer.

## ELECTRONIC VEHICLE INFORMATION CENTER (EVIC)



- The EVIC features a driver interactive display that is located in the instrument cluster. Pressing the controls on the steering wheel allows the driver to select vehicle information and Personal Settings. For additional information, refer to Programmable Features in this guide.
- Press and release the MENU  button and the mode displayed will change between Compass/Temperature, Trip, System Status, and Personal settings.

- Press the STEP  button to scroll through sub menus (i.e., Trip Functions, Avg. Fuel Economy, DTE, Elapsed Time, and Units).
- Press and release the Compass/Temperature  button for instant access to the Compass/Temperature screens.
- Press the RESET  button to RESET Trip Functions and change Personal Settings.

# ELECTRONICS

## UNIVERSAL GARAGE DOOR OPENER



### Programming HomeLink®

#### Begin Programming

- The HomeLink® buttons are located in the sun visor.
  - Erase all channels before you begin training by holding the two outside buttons for up to 20 seconds until the red indicator flashes.
  - Park your vehicle outside of the garage and turn the ignition switch to the ON/RUN position.
- Place the hand-held transmitter 1 to 3 in (3 to 8 cm) from the HomeLink® buttons while keeping the indicator light in view.
  - Simultaneously, press and hold both the chosen HomeLink® button and the hand-held transmitter button until the HomeLink® indicator flash rate changes from a slow to a rapidly blinking light, then release both the HomeLink® and the hand-held transmitter buttons. This may take up to 30 seconds, or longer in rare cases.
  - Press and hold the just-trained HomeLink® button; if the indicator light stays on constantly, programming is complete and the garage door should open.

### WARNING!

- Your motorized door or gate will open and close while you are training the universal transceiver. Do not train the transceiver if people or pets are in the path of the door or gate. Only use this transceiver with a garage door opener that has a “stop and reverse” feature as required by Federal safety standards. This includes most garage door opener models manufactured after 1982. Do not use a garage door opener without these safety features. Call toll-free 1-800-355-3515 or, on the Internet, at [www.HomeLink.com](http://www.HomeLink.com) for safety information or assistance.
- Vehicle exhaust contains Carbon Monoxide (CO), a dangerous gas. Do not run your vehicle in the garage while training the transceiver. Exhaust gas can cause serious injury or death.

**NOTE:** If you are having difficulty training your HomeLink® and your garage door opener was manufactured after 1995, you may have a rolling code. Follow the steps below for Programming A Rolling Code System.

#### Programming A Rolling Code System

- At the garage door opener motor (in the garage), locate the “learn” or “training” button. This can usually be found where the hanging antenna wire is attached to the garage door opener motor (it is NOT the button normally used to open and close the door).



- Firmly press and release the “learn” or “training” button. The name and color of the button may vary by manufacturer. Within 30 seconds, return to the vehicle and press the programmed HomeLink® button twice (holding the button for two seconds each time). If the device is plugged in and activates, programming is complete.
- If the device does not activate, press the button a third time (for two seconds) to complete the training.

## Using HomeLink®

- To operate, simply press and release the programmed HomeLink® button and the trained device will operate.
- Refer to your Owner’s Manual on the DVD for further details. If you have any problems programming HomeLink®, or require assistance, please call toll-free 1-800-355-3515 or, on the Internet, at [www.HomeLink.com](http://www.HomeLink.com).

## POWER OUTLET

- The power outlet is located on the instrument panel below the climate control and is powered when the ignition switch is in the ON position.
- The outlet can operate a conventional cigar lighter unit or power accessories designed for use with a standard power outlet adapter.

**NOTE:** Do not exceed the maximum power of 160 Watts (13 Amps) at 12 Volts. If the 160 Watt (13 Amp) power rating is exceeded the fuse protecting the system will need to be replaced.

## Uconnect™ Phone

- The Uconnect™ Phone is a voice-activated, hands-free, in-vehicle communications system.
- The Uconnect™ Phone allows you to dial a phone number with your cellular phone using simple voice commands.
- For vehicles equipped with Video Entertainment System (VES)™, refer to the Uconnect™ Phone section of the Uconnect™ User’s Manual on the DVD for further details.
- For vehicles not equipped with VES™, refer to your vehicle Owner’s Manual on the DVD for further details.

### WARNING!

- Any voice commanded system should be used only in safe driving conditions following local laws and phone use. All attention should be kept on the roadway ahead. Failure to do so may result in an accident causing serious injury or death.
- Your phone must be turned on and paired to the Uconnect™ Phone to allow use of this vehicle feature in emergency situations, when the cellular phone has network coverage and stays paired to the Uconnect™ Phone.

**NOTE:** The Uconnect™ Phone requires a cellular phone equipped with the Bluetooth® Hands-Free Profile, Version 0.96 or higher. For Uconnect™ customer support, call 1-877-855-8400.

# ELECTRONICS

## Phone Pairing

**NOTE:** Pairing is a one-time initial setup before using the phone. You will also need to follow the Bluetooth® instructions in your cell phone user guide to complete the phone pairing setup.

- Press the Phone button  to begin.
- Wait for the “ready” prompt and beep.
- (After the BEEP), say “Uconnect setup”.
- (After the BEEP), say “phone pairing”.
- (After the BEEP), say “pair a phone”.
- Follow the audible prompts.
- You will be asked to enter a four-digit Personal Identification Number (PIN), which you will later need to enter into your cellular phone. You can enter any four-digit PIN. You will not need to remember this PIN after the initial pairing process.
- You will then be prompted to give the phone pairing a name (each phone paired should have a unique name).
- Next you will be asked to give this new pairing a priority of 1 thru 7 (up to seven phones may be paired).



## Making A Phone Call

- Press the Phone button .
- (After the BEEP), say “dial” (or “call” to a name).
- (After the BEEP), say number (or name).

## Phonebook (Uconnect™ Local) Edit

- Press the Phone button .
- (After the BEEP), say “phonebook”.
- (After the BEEP), say “new entry” or “list names” or “delete”.
- Follow the prompts.

## Receiving A Call – Accept (And End)

- When an incoming call rings/is announced on Uconnect™, press the Phone button .
- To end a call, press the Phone button .

## Mute (Or Unmute) Microphone During Call

- During a call, press the Voice Command button  VR .
- (After the BEEP), say “mute on” (or “mute off”).

## Transfer Ongoing Call Between Handset And Vehicle



- During a call, press the Voice Command button  VR .
- (After the BEEP), say “transfer call”.

## Changing The Volume

- Start a dialogue by pressing the Phone button , then adjust the volume during a normal call.
- Use the radio ON/OFF VOLUME rotary knob to adjust the volume to a comfortable level while the Uconnect™ system is speaking. Please note the volume setting for Uconnect™ is different than the audio system.

**NOTE:** To access the tutorial, press the Uconnect™ hard-key. After the BEEP, say “tutorial”. Press any hard-key or touch the display to cancel the tutorial.

## VOICE COMMAND

- The Voice Command system allows you to control your AM, FM radio, satellite radio, disc player, and a memo recorder. When you press the Voice Command button  VR, you will hear a beep. The beep is your signal to give a command. If you do not say a command within a few seconds, the system will present you with a list of options. If you ever wish to interrupt the system while it lists options, press the Voice Command button  VR, listen for the BEEP, and say your command.
- For vehicles equipped with Video Entertainment System (VES)™, refer to the Voice Command section of the Uconnect™ User's Manual on the DVD for further details.
- For vehicles not equipped with VES™, refer to your vehicle Owner's Manual on the DVD for Voice Command information.

## Changing The Volume

- Start a dialogue by pressing the Voice Command button  VR, then say a command (e.g., “tutorial”).
- Use the radio ON/OFF VOLUME rotary knob to adjust the volume to a comfortable level while the Voice Command system is speaking. Please note the volume setting for Voice Command is different than the audio system.

### WARNING!

Any voice commanded system should be used only in safe driving conditions and all attention should be kept on the roadway ahead. Failure to do so may result in an accident causing serious injury or death.

**NOTE:** To access the tutorial, press the Voice Command button  VR. After the BEEP, say “tutorial”. Press any hard-key or touch the display to cancel the tutorial.

# OFF-ROAD CAPABILITIES

## FOUR-WHEEL DRIVE OPERATION



### Operating Information/Precautions

- This is an electric shift transfer case and is operated by the transfer case control knob (located on the center console).
  - The electronically shifted transfer case is designed to be driven in the two-wheel drive position (2WD) for normal street and highway conditions (dry, hard-surfaced roads).
- When additional traction is required, rotate the transfer case switch to the 4WD LOCK position to lock the front and rear driveshafts together and force the front and rear wheels to rotate at the same speed.

### 2WD To 4WD LOCK

- Shifts between 2WD and 4WD LOCK can be done with the vehicle stopped or in motion. With the vehicle in motion, the transfer case will engage/disengage faster if you momentarily release the accelerator pedal after turning the control knob.
- If the vehicle is stopped, the key must be in the ON position.
- Shifts can not be completed if the key is in the ACC position.

**NOTE:** Do not attempt to make a shift while only the front or rear wheels are spinning. Shifting while only the front or rear wheels are spinning can cause damage to the transfer case.

## CARGO AREA FEATURES

### Cargo Tie-Down Hooks

- The tie-downs located on the cargo area floor should be used to safely secure loads when the vehicle is moving.

### WARNING!

- Cargo tie-downs are not safe anchors for a child seat tether strap. In a sudden stop or collision, a tie-down could pull loose and allow the child seat to come loose. A child could be badly injured. Use only the anchors provided for child seat tethers.
- To help protect against personal injury, passengers should not be seated in the rear cargo area. The rear cargo space is intended for load carrying purposes only, not for passengers, who should sit in seats and use seat belts.

### Cargo Load Floor



- The panel in the load floor is reversible for added utility. One side features a plastic lined tray which can hold a variety of items. The maximum load capacity of the load floor is 400 lbs (181 kg).

## TRAILER TOWING WEIGHTS (MAXIMUM TRAILER WEIGHT RATINGS)

# UTILITY

Engine/Transmission	Model	Frontal Area	Max GTW (Gross Trailer Wt)	Tongue Wt. (See Note)
3.7L/Automatic	4X2	32 sq ft (2.97 sq m)	2,000 lbs (907 kg)	200 lbs (91 kg)
3.7L/Automatic	4X4	32 sq ft (2.97 sq m)	2,000 lbs (907 kg)	200 lbs (91 kg)
4.0L/Automatic	4X2	32 sq ft (2.97 sq m)	2,000 lbs (907 kg)	200 lbs (91 kg)
4.0L/Automatic	4X4	32 sq ft (2.97 sq m)	2,000 lbs (907 kg)	200 lbs (91 kg)

Refer to local laws for maximum trailer towing speeds.

**NOTE: The trailer tongue weight must be considered as part of the combined weight of occupants and cargo, and should never exceed the weight referenced on the Tire and Loading Information placard.**

## When Towing Trailers With Gross Trailer Weight (GTW) Between 3,500 Lbs (1 588 kg) And 5,000 Lbs (2 268 kg)

The following chart provides maximum trailer weight ratings towable for the following engine/transmission combinations, ONLY if using a weight distributing hitch.

Engine/Transmission	Model	Frontal Area	Max GTW (Gross Trailer Wt)	Tongue Wt. (See Note)
3.7L/Automatic w/Trailer Tow Package	4X2	64 sq ft (5.94 sq m)	5,000 lbs (2 268 kg)	500 lbs (227 kg)
3.7L/Automatic w/Trailer Tow Package	4X4	64 sq ft (5.94 sq m)	5,000 lbs (2 268 kg)	500 lbs (227 kg)
4.0L/Automatic w/Trailer Tow Package	4X2	64 sq ft (5.94 sq m)	5,000 lbs (2 268 kg)	500 lbs (227 kg)
4.0L/Automatic w/Trailer Tow Package	4X4	64 sq ft (5.94 sq m)	5,000 lbs (2 268 kg)	500 lbs (227 kg)

Refer to local laws for maximum trailer towing speeds.

**NOTE: The trailer tongue weight must be considered as part of the combined weight of occupants and cargo, and should never exceed the weight referenced on the Tire and Loading Information placard.**

## RECREATIONAL TOWING (BEHIND MOTORHOME, ETC.)

### Towing — Two-Wheel Drive Models

#### Recreational Towing (All Four Wheels On The Ground)

- Recreational towing is allowed ONLY if the driveshaft is removed. Towing with the rear wheels on the ground while the driveshaft is connected can result in severe transmission damage.

#### WARNING!

If the driveshaft is removed, the vehicle can roll even if the transmission is in PARK, which could cause serious injury or death.

- The parking brake must be firmly engaged and the wheels chocked during driveshaft removal and installation. The parking brake must remain engaged unless the vehicle is securely and properly connected to the tow vehicle, or the driveshaft is completely reinstalled. See your authorized dealer for proper driveshaft removal and reinstallation procedures, including flange orientation/alignment, use of thread-locking compound, proper bolt torque specifications, etc.

**NOTE:** This vehicle may be towed on a flatbed or vehicle trailer provided all four wheels are OFF the ground.

### Towing — Four-Wheel Drive Or All-Wheel Drive Models

#### CAUTION!

Front or rear wheel lifts should not be used. Internal damage to the transmission or transfer case will occur if a front or rear wheel lift is used when recreational towing.

#### Recreational Towing (All Four Wheels On The Ground)

- Recreational towing is NOT allowed. These models do not have a NEUTRAL position in the transfer case.

**NOTE:** This vehicle may be towed on a flatbed or vehicle trailer provided all four wheels are OFF the ground.

- Refer to your Owner's Manual on the DVD for further details.

# UTILITY

## **BRAKE/TRANSMISSION INTERLOCK MANUAL OVERRIDE**

- The manual override may be used in the event that the shift lever should fail to move from PARK with the Key Fob in the ON position and the brake pedal pressed.
- To operate the shift lock manual override, perform the following steps:
  - Turn the Key Fob to the ON position but do not start the engine.
  - Firmly set the parking brake.
  - Using a flat-bladed screwdriver, carefully remove the shift lock manual override cover which is located on the PRNDL bezel.
- Press and maintain firm pressure on the brake pedal.
- Using a screwdriver, reach into the manual override opening. Press and hold the shift lock lever down.
- Move the shift lever into the NEUTRAL position and start the vehicle.
- Have your vehicle inspected by your local authorized dealer if the shift lock manual override has been used.



# WHAT TO DO IN EMERGENCIES

## 24-HOUR TOWING ASSISTANCE - U.S. ONLY

- Dial toll-free 1-800-521-2779 or 1-800-363-4869 for Canadian residents.
- Provide your name, vehicle identification number and license plate number.
- Provide your location, including telephone number, from which you are calling.
- Briefly describe the nature of the problem and answer a few simple questions.
- You will be given the name of the service provider and an estimated time of arrival. If you feel you are in an “unsafe situation”, please let us know. With your consent, we will contact local police or safety authorities.

## INSTRUMENT CLUSTER WARNING LIGHTS

### - Electronic Stability Program (ESP) Indicator Light

- If this indicator light flashes during acceleration, apply as little throttle as possible. While driving, ease up on the accelerator. Adapt your speed and driving to the prevailing road conditions. To improve the vehicle's traction when starting off in deep snow, sand or gravel, it may be desirable to switch the ESP system off.

### - Tire Pressure Monitoring System (TPMS) Light

- A Tire Pressure Monitoring Light and a “low tire” message will display in your instrument cluster along with an audible chime if one or more of your vehicle's four road tires are significantly under-inflated.
- Check the inflation pressure of each tire and inflate to the recommended pressure for your vehicle. The tire pressures recommended for your vehicle are found on the “Tire and Loading Information” label located on the driver's side door opening. The TPMS light should not be used as a tire pressure gauge when adjusting your tire pressure.
- It is recommended that you check the tire pressure in the morning when tires are cool; inflate each tire to the recommended pressure for your vehicle. The light will turn off after your vehicle's tire pressures are properly inflated and the pressure has been recognized. The vehicle may need to be driven for up to 20 minutes above 15 mph (25 km/h) before the light will turn off.
- Temperature changes can affect tire pressure, causing the TPMS light to turn on. Tire pressures will also increase as the vehicle is driven – this is normal and you should not adjust for this increased pressure.
- Driving on under-inflated tires reduces your vehicle's fuel efficiency and tire tread life. If a spare tire is in use on the vehicle, the TPMS light may turn on.

### - Engine Temperature Warning Light

- This light warns of an overheated engine condition.
- If the light turns on and a warning chime sounds while driving, safely pull over and stop the vehicle. If the A/C system is on, turn it off. Also, shift the transmission into NEUTRAL and idle the vehicle. If the temperature reading does not return to normal, turn the engine off immediately.
- We recommend that you do not operate the vehicle or engine damage will occur. Have the vehicle serviced immediately.

# WHAT TO DO IN EMERGENCIES

## WARNING!

A hot engine cooling system is dangerous. You or others could be badly burned by steam or boiling coolant. You may want to call an authorized dealership for service if your vehicle overheats.

### **BRAKE - Brake Warning Light**

- The Brake Warning light illuminates when there is either a system malfunction or the parking brake is applied. If the light is on and the parking brake is not applied, it indicates a possible brake hydraulic malfunction, brake booster problem or an Anti-Lock Brake System problem.
- We recommend you do not operate the vehicle. Have the vehicle serviced immediately.

## WARNING!

Driving a vehicle with the red brake light on is dangerous. Part of the brake system may have failed. It will take longer to stop the vehicle. You could have an accident. Have the vehicle checked immediately.

### **Malfunction Indicator Light (MIL)**

- Certain conditions, such as a loose or missing gas cap, poor fuel quality, etc., may illuminate the MIL after engine start. The vehicle should be serviced if the light stays on through several typical driving cycles. In most situations, the vehicle will drive normally and not require towing.
- If the MIL flashes when the engine is running, serious conditions may exist that could lead to immediate loss of power or severe catalytic converter damage. We recommend you do not operate the vehicle. Have the vehicle serviced immediately.

### **ESP/BAS - Electronic Stability Program (ESP) Indicator Light/Brake Assist System (BAS) Warning Light**

- If the ESP/BAS warning light comes on continuously with the engine running, a malfunction has been detected.
- If this light remains on after several ignition cycles, and the vehicle has been driven several miles (kilometers) at speeds greater than 30 mph (48 km/h), we recommend you do not operate the vehicle. Have the vehicle serviced immediately.

### **Charging System Light**

- This light shows the status of the electrical charging system. If the charging system light remains on, it means that the vehicle is experiencing a problem with the charging system.
- We recommend you do not continue driving if the charging system light is on. Have the vehicle serviced immediately.

# WHAT TO DO IN EMERGENCIES

## - Oil Pressure Warning Light

- This light indicates low engine oil pressure. If the light turns on while driving, stop the vehicle and shut off the engine as soon as possible. A chime will sound for four minutes when this light turns on.
- We recommend you do not operate the vehicle or engine damage will occur. Have the vehicle serviced immediately.

## - Anti-Lock Brake (ABS) Light

- This light monitors the Anti-Lock Brake System (ABS).
- If the light is not on during starting, stays on, or turns on while driving, we recommend you do not operate the vehicle. Have the vehicle serviced immediately.

## - Electronic Throttle Control (ETC) Light

- This light informs you of a problem with the Electronic Throttle Control (ETC) system.
- If a problem is detected, the light will come on while the engine is running. Cycle the ignition key when the vehicle has completely stopped and the shift lever is placed in the PARK position; the light should turn off.
- If the light remains lit with the engine running, your vehicle will usually be drivable; however, see an authorized dealer for service as soon as possible. If the light is flashing when the engine is running, immediate service is required and you may experience reduced performance, an elevated/rough idle or engine stall and your vehicle may require towing. We recommend you do not operate the vehicle. Have the vehicle serviced immediately.

## - Airbag Warning Light

- If the light is not on during starting, stays on, or turns on while driving, we recommend you do not operate the vehicle. Have the vehicle serviced immediately.

## - SERV (Service) 4WD Indicator Light

- If the light stays on or comes on during driving, it means that the 4WD system is not functioning properly and that service is required. We recommend you do not operate the vehicle. Have the vehicle serviced immediately.

## - Transmission Temperature Warning Light

- This light indicates that there is excessive transmission fluid temperature that might occur with severe usage such as trailer towing. If this light turns on, stop the vehicle and run the engine at idle, with the transmission in NEUTRAL, until the light turns off. Once the light turns off, you may continue to drive normally.

## Fuel Cap/Loose Gas Cap Message

- If a “gas cap” message (shown as gASCAP) appears, tighten the gas cap until a “clicking” sound is heard.
- Press the odometer reset button to turn the message off.
- If the message continues to appear for more than three days after tightening the gas cap, see your authorized dealer.

# WHAT TO DO IN EMERGENCIES

## Oil Change Indicator

### Message

- If an “oil change” message (shown as CHAnGE OIL) appears and a single chime sounds, it is time for your next required oil change.

### Resetting The Light After Servicing

- Turn the ignition switch to the ON/RUN position (do not start engine).
- Fully depress the accelerator pedal three times within 10 seconds.
- Turn the ignition switch to the OFF/LOCK position.

## IF YOUR ENGINE OVERHEATS

- In any of the following situations, you can reduce the potential for overheating by taking the appropriate action.
  - On the highways — slow down.
  - In city traffic — while stopped, shift transmission into NEUTRAL, but do not increase engine idle speed.

**NOTE:** There are steps that you can take to slow down an impending overheat condition:

- If your air conditioner (A/C) is on, turn it off. The A/C system adds heat to the engine cooling system and turning the A/C off can help remove this heat.
- You can also turn the Temperature Control to maximum heat, the Mode Control to floor and the Fan Control to high. This allows the heater core to act as a supplement to the radiator and aids in removing heat from the engine cooling system.
- If the temperature reading does not return to normal, turn the engine off immediately.
- We recommend that you do not operate the vehicle or engine damage will occur. Have the vehicle serviced immediately.

### CAUTION!

Driving with a hot cooling system could damage your vehicle. If the temperature gauge reads HOT (H), pull over and stop the vehicle. Idle the vehicle with the air conditioner turned off until the pointer drops back into the normal range. If the pointer remains on HOT (H), and you hear continuous chimes, turn the engine off immediately and call for service.

### WARNING!

You or others can be badly burned by hot engine coolant (antifreeze) or steam from your radiator. If you see or hear steam coming from under the hood, do not open the hood until the radiator has had time to cool. Never try to open a cooling system pressure cap when the radiator or coolant bottle is hot.

# WHAT TO DO IN EMERGENCIES

## JACKING AND TIRE CHANGING

### WARNING!

- Do not attempt to change a tire on the side of the vehicle close to moving traffic. Pull far enough off the road to avoid the danger of being hit when operating the jack or changing the wheel.
- Getting under a jacked-up vehicle is dangerous. The vehicle could slip off the jack and fall on you. You could be crushed. Never get any part of your body under a vehicle that is on a jack. If you need to get under a raised vehicle, take it to a service center where it can be raised on a lift.
- The jack is designed to use as a tool for changing tires only. The jack should not be used to lift the vehicle for service purposes. The vehicle should be jacked on a firm, level surface only. Avoid ice or slippery areas.
- If it is necessary to retrieve the spare tire from under the vehicle on the side of the vehicle close to moving traffic, pull far enough off the road to avoid the danger of being hit.

### Jack Location



- The scissor-type jack and tire changing tools are located in the left rear trim panel behind the second row seat.

### Spare Tire Stowage

- To remove the spare tire, remove the jack-handle components from the storage bin in the left rear trim panel and assemble them.
- Lower the spare tire by turning the winch drive nut, located in the rear cargo area inside the vehicle, counterclockwise with the jack-handle assembly until the spare tire is on the ground with enough cable slack to allow you to pull the spare tire out from underneath the vehicle.
- When the spare is clear, tilt the retainer at the end of the cable and pull it through the center of the wheel.

# WHAT TO DO IN EMERGENCIES

## Preparations For Jacking

- Park on a firm, level surface. Avoid ice or slippery areas.
- Set the parking brake and shift the automatic transmission into PARK.
- Turn the ignition to LOCK and turn on the Hazard Warning flasher.

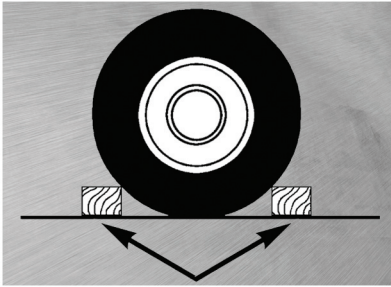

- Block both the front and rear of the wheel diagonally opposite of the jacking position. For example, if changing the right front tire, block the left rear wheel.

**NOTE:** Passengers should not remain in the vehicle when the vehicle is being jacked.

## Jacking And Tire Changing Instructions

### WARNING!

Carefully follow these tire changing procedures to help prevent personal injury or damage to your vehicle: Always park on a firm, level surface as far from the edge of the roadway as possible before raising the vehicle.

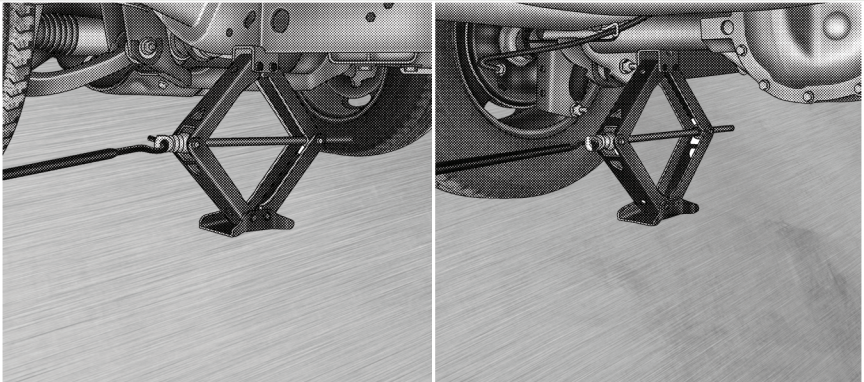

- Remove the spare tire, jack and tools from the stored location.
- Loosen (but do not remove) the wheel lug nuts by turning them to the left one turn while the wheel is still on the ground.
- Assemble the jack and jacking tools. Connect the jack handle driver to the extension, then to the lug wrench.

# WHAT TO DO IN EMERGENCIES

- Locate the jack:
  - For the front tires, place it (rearward) of the notch on the body weld seam behind the wheel to be changed.
  - For the rear tires, place it under the axle by the wheel to be changed.
- Raise the vehicle by turning the jack screw clockwise. Raise the vehicle only until the tire just clears the surface and enough clearance is obtained to install the spare tire.

## WARNING!

Raising the vehicle higher than necessary can make the vehicle less stable and cause an accident. It could slip off the jack and hurt someone near it. Raise the vehicle only enough to remove the tire.

- Remove the lug nuts, wheel cover (if equipped) and the wheel.
- Position the spare wheel/tire on the vehicle and install the lug nuts with the cone-shaped end toward the wheel. Do NOT attempt to install a center cap or wheel cover on the compact spare. Lightly tighten the lug nuts clockwise. To avoid the risk of forcing the vehicle off the jack, do not tighten the nuts fully until the vehicle has been lowered.
- Lower the vehicle by turning the jack screw to the left, and remove the jack and wheel blocks.
- Finish tightening the lug nuts. Push down on the wrench while tightening for increased leverage. Alternate nuts until each one has been tightened twice. The correct wheel nut tightness is 95 ft lbs (130 N•m). If in doubt about the correct tightness, have them checked with a torque wrench by your authorized dealer or at a service station.

## WARNING!

A loose tire or jack, thrown forward in a collision or hard stop, could endanger the occupants of the vehicle. Always stow the jack parts and the spare tire in the places provided.

- Secure the tire, jack, and tools in their proper locations.

# WHAT TO DO IN EMERGENCIES

## JUMP-STARTING



- If your vehicle has a discharged battery it can be jumpstarted using a set of jumper cables and a battery in another vehicle or by using a portable battery booster pack.
- Jump-starting can be dangerous if done improperly so please follow the procedures in this section carefully.

**NOTE:** When using a portable battery booster pack follow the manufacturer's operating instructions and precautions.

### CAUTION!

Do not use a portable battery booster pack or any other booster source with a system voltage greater than 12 Volts or damage to the battery, starter motor, alternator or electrical system may occur.

### WARNING!

When temperatures are below the freezing point, electrolyte in a discharged battery may freeze. Do not attempt jump-starting because the battery could rupture or explode and cause personal injury. Battery temperature must be brought above the freezing point before attempting a jump-start.



# WHAT TO DO IN EMERGENCIES

## Preparations for Jump-Start

- The battery in your vehicle is located in the front of the engine compartment, behind the left headlight assembly.

**NOTE:** The positive battery post is covered with a protective cap. Lift up on the cap to gain access to the positive battery post.

### WARNING!

- Take care to avoid the radiator cooling fan whenever the hood is raised. It can start anytime the ignition switch is on. You can be injured by moving fan blades.
  - Remove any metal jewelry, such as watch bands or bracelets, that might make an inadvertent electrical contact. You could be seriously injured.
  - Batteries contain sulfuric acid that can burn your skin or eyes and generate hydrogen gas which is flammable and explosive. Keep open flames or sparks away from the battery.
- Set the parking brake, shift the automatic transmission into PARK and turn the ignition to LOCK.
  - Turn off the heater, radio, and all unnecessary electrical accessories.
  - If using a another vehicle to jump-start the battery, park the vehicle within the jumper cables reach, set the parking brake and make sure the ignition is OFF.

### WARNING!

Do not allow vehicles to touch each other as this could establish a ground connection and personal injury could result.

## Jump-Starting Procedure

### WARNING!

Failure to follow this procedure could result in personal injury or property damage due to battery explosion.

### CAUTION!

Failure to follow these procedures could result in damage to the charging system of the booster vehicle or the discharged vehicle.

- Connect the positive (+) end of the jumper cable to the positive (+) post of the discharged vehicle.
- Connect the opposite end of the positive (+) jumper cable to the positive (+) post of the booster battery.

# WHAT TO DO IN EMERGENCIES

- Connect the negative end (-) of the jumper cable to the negative (-) post of the booster battery.
- Connect the opposite end of the negative (-) jumper cable to a good engine ground (exposed metal part of the discharged vehicle's engine) away from the battery and the fuel injection system.

## WARNING!

Do not connect the cable to the negative post (-) of the discharged battery. The resulting electrical spark could cause the battery to explode and could result in personal injury.

- Start the engine in the vehicle that has the booster battery, let the engine idle a few minutes, and then start the engine in the vehicle with the discharged battery. Once the engine is started, remove the jumper cables in the reverse sequence:
- Disconnect the negative (-) jumper cable from the engine ground of the vehicle with the discharged battery.
- Disconnect the negative end (-) of the jumper cable from the negative (-) post of the booster battery.
- Disconnect the opposite end of the positive (+) jumper cable from the positive (+) post of the booster battery.
- Disconnect the positive (+) end of the jumper cable from the positive (+) post of the discharged vehicle.
- If frequent jump-starting is required to start your vehicle you should have the battery and charging system inspected at your authorized dealer.

## CAUTION!

Accessories that can be plugged into the vehicle power outlets draw power from the vehicle's battery, even when not in use (i.e., cellular phones, etc.). Eventually, if plugged in long enough, the vehicle's battery will discharge sufficiently to degrade battery life and/or prevent the engine from starting.

# WHAT TO DO IN EMERGENCIES

## TOWING A DISABLED VEHICLE

Model	Flat Towing (all four wheels on the ground)	Flatbed Towing (all four wheels suspended OFF the ground)	Front Wheels Raised, Rear Wheels on the Ground	Rear Wheels Raised, Front Wheels on the Ground
<b>Two-Wheel Drive</b>	NOT Permitted	Recommended Method	Shift lever must be in NEUTRAL, the speed less than 30 mph (48 km/h) and the distance traveled less than 15 mi (24 km).	Shift lever must be in NEUTRAL, the speed less than 30 mph (48 km/h) and the distance traveled less than 15 mi (24 km).
<b>Four-Wheel Drive</b>	NOT Permitted	Recommended Method	NOT Permitted	NOT Permitted

# WHAT TO DO IN EMERGENCIES

## EVENT DATA RECORDER (EDR)

- In the event of an accident, your vehicle is designed to record up to five seconds of specific vehicle data parameters (see list below) in an event data recorder prior to the moment of airbag deployment, or near deployment (if applicable), and up to a quarter second of either high-speed deceleration data or change in velocity during and/or after airbag deployment or near-deployment. EDR data is ONLY recorded if an airbag deploys, or nearly deploys, and is otherwise unavailable.

### NOTE:

- A near-deployment event occurs when the airbag sensor detects severe vehicle deceleration usually indicative of a crash, but not severe enough to warrant airbag deployment.
- Under certain circumstances, EDR data may not be recorded (e.g., loss of battery power).
- In conjunction with other data gathered during a complete accident investigation, the electronic data may be used by Chrysler Group LLC and others to learn more about the possible causes of crashes and associated injuries in order to assess and improve vehicle performance. In addition to crash investigations initiated by Chrysler Group LLC, such investigations may be requested by customers, insurance carriers, government officials, and professional crash researchers, such as those associated with universities, and with hospital and insurance organizations.
- In the event that an investigation is undertaken by Chrysler Group LLC (regardless of initiative), the company or its designated representative will first obtain permission of the appropriate custodial entity for the vehicle (usually the vehicle owner or lessee) before accessing the electronic data stored, unless ordered to image the data by a court with legal jurisdiction (i.e., pursuant to a warrant). A copy of the data will be provided to the custodial entity upon request. General data that does not identify particular vehicles or crashes may be released for incorporation in aggregate crash databases, such as those maintained by the U.S. government and various states. Data of a potentially sensitive nature, such as would identify a particular driver, vehicle, or crash, will be treated confidentially. Confidential data will not be disclosed by Chrysler Group LLC to any third party except when:
  - Used for research purposes, such as to match data with a particular crash record in an aggregate database, provided confidentiality of personal data is thereafter preserved.
  - Used in defense of litigation involving a Chrysler Group LLC product.
  - Requested by police under a legal warrant.
  - Otherwise required by law.

### Data parameters that are recorded:

- Diagnostic trouble code(s) and warning light status for electronically-controlled safety systems, including the airbag system
- Vehicle speed
- Engine RPM
- Brake switch status
- Pedal position
- And other parameters depending on vehicle configuration

# MAINTAINING YOUR VEHICLE

## OPENING THE HOOD

- Pull the release lever located below the instrument panel and in front of the driver's door.
- Raise the hood and locate the safety latch, in the middle of the hood opening.
- Move the safety latch while lifting the hood at the same time.
- Insert the support rod into the slot on the hood.
- To close the hood, remove the support rod and place it in the retaining clip, then lower the hood slowly.

### WARNING!

Be sure the hood is fully latched before driving your vehicle. If the hood is not fully latched, it could open when the vehicle is in motion and block your vision. Failure to follow this warning could result in serious injury or death.

# MAINTAINING YOUR VEHICLE

## ENGINE COMPARTMENT

3-7L Engine

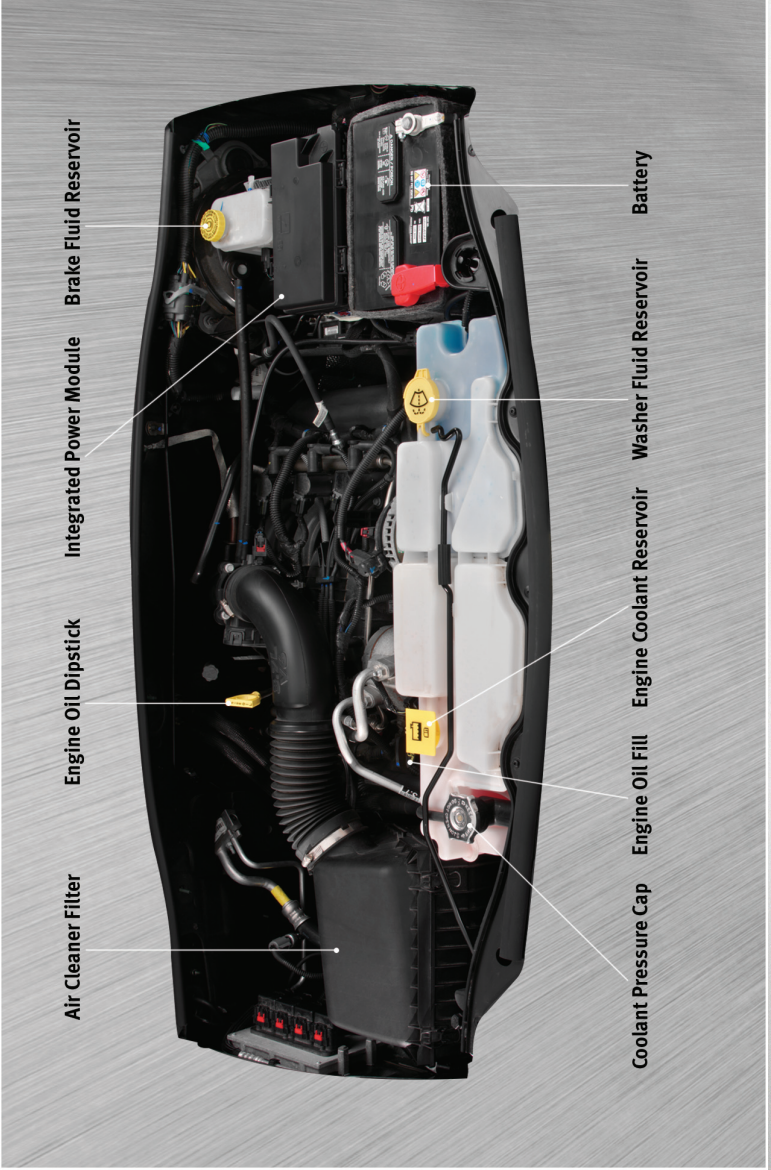

# MAINTAINING YOUR VEHICLE

## 4.0L Engine

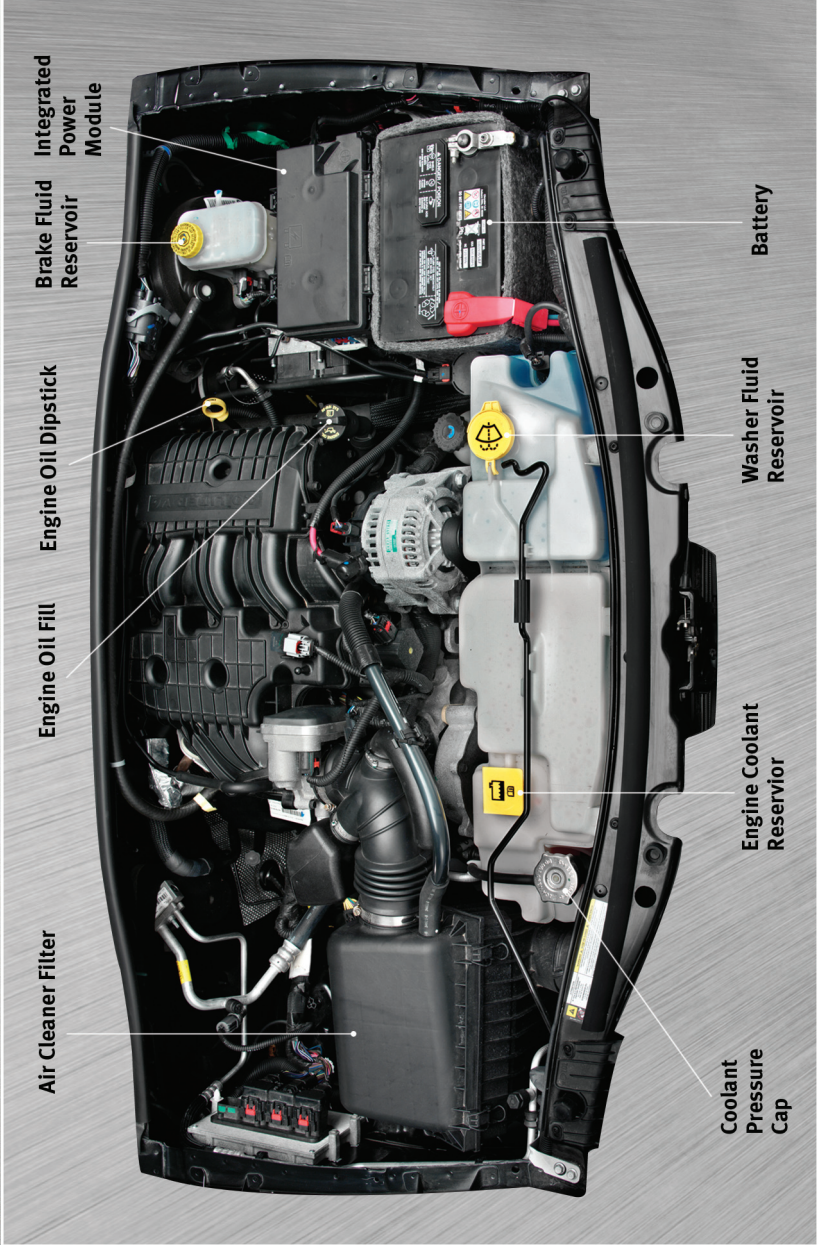

# MAINTAINING YOUR VEHICLE

## FLUIDS AND CAPACITIES

Component	Fluid, Lubricant, or Genuine Part	Capacities
Engine Coolant 3.7L, 4.0L	MOPAR <sup>®</sup> Antifreeze/ Coolant Five Year/100,000 Mile Formula HOAT (Hybrid Organic Additive Technology) or equivalent.	14 Quarts (13.3 Liters) Includes heater and coolant recovery bottle filled to MAX level.
Engine Oil with Filter 3.7L	API certified 5W-20 engine oil, meeting the requirements of Chrysler Material Standard MS-6395. Refer to your oil filler cap for correct SAE grade.	5 Quarts (4.7L Liters)
Engine Oil with Filter 4.0L	API certified 10W-30 engine oil, meeting the requirements of Chrysler Material Standard MS-6395. Refer to your oil filler cap for correct SAE grade.	5.5 Quarts (5.2 Liters)
Fuel Selection 3.7L, 4.0L	87 Octane acceptable. 89 octane Recommended for 4.0L.	19.5 Gallons (73.8 Liters)
Engine Oil Filter 3.7L, 4.0L	MOPAR <sup>®</sup> Engine Oil Filter or equivalent.	—
Spark Plug 3.7L	ZFR6F-11G (Gap 0.043 in [1.09 mm])	—
Spark Plug 4.0L	ZFR5LP-13G (Gap 0.050 in [1.27 mm])	—
Automatic Transmission	MOPAR <sup>®</sup> ATF+4 <sup>®</sup> Automatic Transmission Fluid or equivalent licensed ATF+4 <sup>®</sup> product.	—
Transfer Case	MOPAR <sup>®</sup> ATF+4 <sup>®</sup> Automatic Transmission Fluid or equivalent licensed ATF+4 <sup>®</sup> product.	—
Front Axle	SAE80W-90 Multi-Purpose Type GL-5 Gear Lube or equivalent.	—
Rear Axle	MOPAR <sup>®</sup> Synthetic Gear & Axle Lubricant SAE 75W-90 or equivalent.	—



# MAINTAINING YOUR VEHICLE

Component	Fluid, Lubricant, or Genuine Part	Capacities
Brake Master Cylinder	MOPAR <sup>®</sup> DOT 3 and SAE J1703 should be used or equivalent. If DOT 3 is not available, then DOT 4 is acceptable. Use Only recommended Brake Fluids.	—
Power Steering Reservoir	MOPAR <sup>®</sup> ATF+4 <sup>®</sup> Automatic Transmission Fluid or equivalent licensed ATF+4 <sup>®</sup> product.	—

# MAINTAINING YOUR VEHICLE

## MAINTENANCE CHART

Miles:	6,000	12,000	18,000	24,000	30,000	36,000	42,000	48,000	54,000	60,000	66,000	72,000	78,000
Or Months:	6	12	18	24	30	36	42	48	54	60	66	72	78
Or Kilometers:	10,000	20,000	30,000	40,000	50,000	60,000	70,000	80,000	90,000	100,000	110,000	120,000	130,000
Change the engine oil and engine oil filter.	X	X	X	X	X	X	X	X	X	X	X	X	X
Rotate the tires.	X	X	X	X	X	X	X	X	X	X	X	X	X
If using your vehicle for any of the following: dusty or off-road conditions. Inspect the engine air cleaner filter; replace if necessary.		X		X		X		X				X	
Inspect the brake linings; replace if necessary.		X		X		X		X			X		
Inspect the CV joints. Perform the first inspection at 12,000 miles (20,000 km) or 12 months.		X		X				X				X	
Inspect the exhaust system. Perform the first inspection at 12,000 miles (20,000 km) or 12 months.		X		X				X				X	
Replace the engine air cleaner filter.					X					X			
Inspect the front and rear axle fluid, change if using your vehicle for police, taxi, fleet, off-road or frequent trailer towing.			X			X			X			X	
Inspect the transfer case fluid.					X								
Change the transfer case fluid if using your vehicle for the following: police, taxi, fleet or frequent trailer towing.										X			
Adjust the parking brake on vehicles equipped with four wheel disc brakes.					X						X		
Change the automatic transmission fluid and filter if using your vehicle for any of the following: police, taxi, fleet or frequent trailer towing.											X		
Inspect front suspension, tie rod ends, and boot seals for cracks or leaks and all parts for damage, wear, improper looseness or end play; replace if necessary.		X		X		X		X			X	X	
Replace the spark plugs (3.7L engine).					X					X			

- Refer to the Owner's Manual on the DVD for the complete maintenance schedule.

# MAINTAINING YOUR VEHICLE

## Maintenance Record

	Odometer	Date	Signature, Authorized Service Center
6,000 Miles (10,000 km) or 6 Months			
12,000 Miles (20,000 km) or 12 Months			
18,000 Miles (30,000 km) or 18 Months			
24,000 Miles (40,000 km) or 24 Months			
30,000 Miles (50,000 km) or 30 Months			
36,000 Miles (60,000 km) or 36 Months			
42,000 Miles (70,000 km) or 42 Months			
48,000 Miles (80,000 km) or 48 Months			
54,000 Miles (90,000 km) or 54 Months			
60,000 Miles (100,000 km) or 60 Months			
66,000 Miles (110,000 km) or 66 Months			
72,000 Miles (120,000 km) or 72 Months			
78,000 Miles (130,000 km) or 78 Months			

# MAINTAINING YOUR VEHICLE

## FUSES

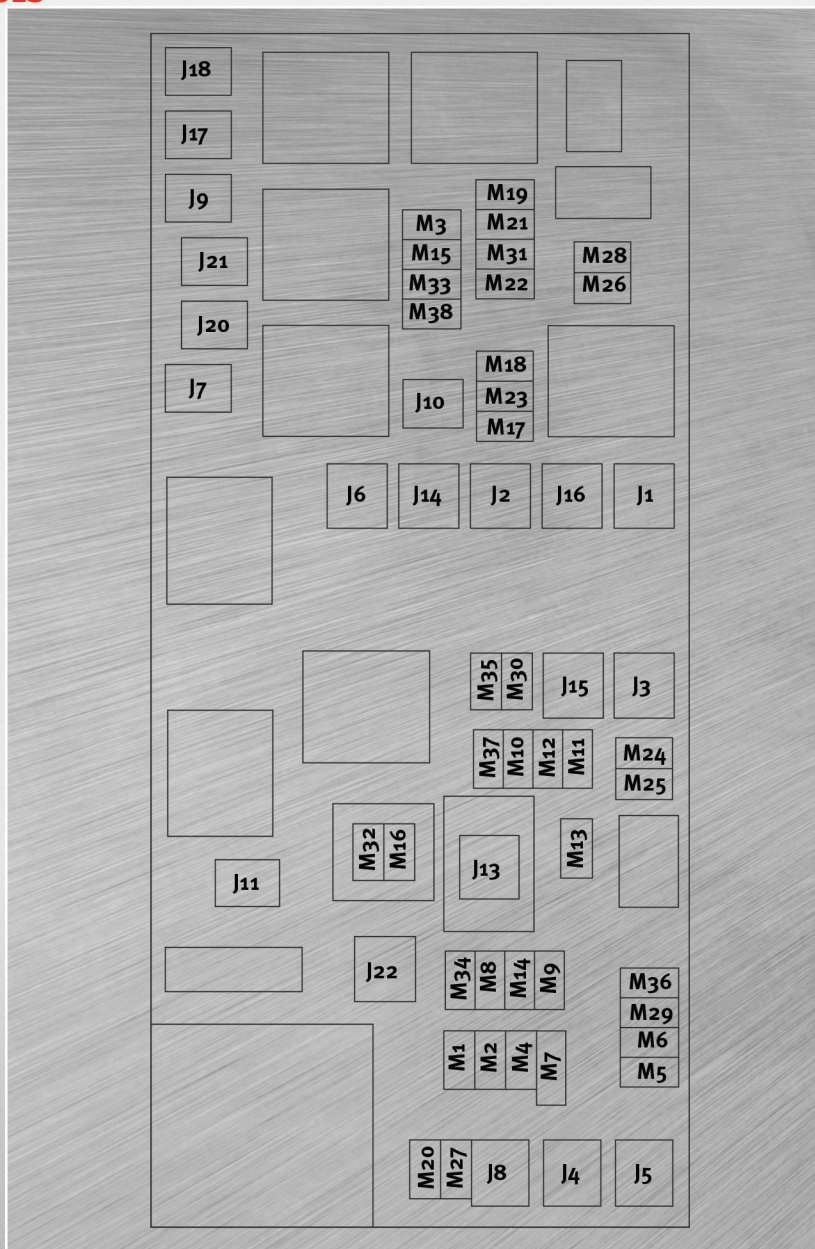

# MAINTAINING YOUR VEHICLE

## Totally Integrated Power Module

- The Totally Integrated Power Module (TIPM) is located in the engine compartment near the battery. This center contains cartridge fuses, mini-fuses and relays.

Cavity	Cartridge Fuse	Mini-Fuse	Description
J1	40 Amp Green		Power Folding Seat
J2	30 Amp Pink		Transfer Case/Pwr Liftgate Module
J3	40 Amp Green		Rear Door Module (RR DOOR NODE)
J4	25 Amp Natural		Driver Door Node
J5	25 Amp Natural		Passenger Door Node
J6	40 Amp Green		Anti-Lock Brake System (ABS) Pump/ESP
J7	30 Amp Pink		Anti-Lock Brake System (ABS) Valve/ESP
J8	40 Amp Green		Power Memory Seat (If Equipped)
J9	40 Amp Green		PZEV Motor/Flex Fuel
J10	30 Amp Pink		Hdlp Wash Relay/Manual Tuning Valve
J11	30 Amp Pink		Sway Bar/THATCHAM Lock-Unlock/Power Sliding Door Module
J13	60 Amp Yellow		Ignition Off Draw (IOD) — Main
J14	40 Amp Green		EBL (Rear Window Defogger)
J15	30 Amp Pink		Rear Blower
J17	40 Amp Green		Starter Solenoid
J18	20 Amp Blue		Powertrain Control Module (PCM) Trans Range
J19	60 Amp Yellow		Radiator Fan
J20	30 Amp Pink		Front Wiper LO/HI
J21	20 Amp Blue		Front/Rear Washer
J22	25 Amp Natural		Sunroof Module
M1		15 Amp Blue	Center High Mounted Stop Light (CHMSL)/Brake Switch
M2		20 Amp Yellow	Trailer Lighting
M3		20 Amp Yellow	Frt/Rear Axle Lockers
M4		10 Amp Red	Trailer Tow
M5		25 Amp Natural	Inverter
M6		20 Amp Yellow	Power Outlet #1/Rain Sensor
M7		20 Amp Yellow	Power Outlet #2 (BATT/ACC SELECT)
M8		20 Amp Yellow	Front Heated Seat
M9		20 Amp Yellow	Rear Heated Seat (If Equipped)

# MAINTAINING YOUR VEHICLE

Cavity	Cartridge Fuse	Mini-Fuse	Description
M10		20 Amp Yellow	Ignition Off Draw — Vehicle Entertainment System (IOD-VES), Satellite Digital Audio Receiver (SDARS), DVD, Hands-Free Module (HFM), RADIO, Antenna (ANT), Universal Garage Door Opener (UGDO), Vanity Lamp (VANITY LP)
M11		10 Amp Red	(Ignition Off Draw) IOD-HVAC/ATC, MW SENSR, Underhood Lamp (UH LMP)
M12		30 Amp Green	Amplifier (AMP)
M13		20 Amp Yellow	Ignition Off Draw— Cabin Compartment Node (IOD-CCN), Wireless Control Module (WCM), SIREN, Clock Module (CLK MOD), Multifunction Control Switch (MULTIFCTN SW)
M14		20 Amp Yellow	Trailer Tow (Export Only)
M15		20 Amp Yellow	COL MOD, IR SNS, Heater Ventilation, Air Conditioning/Automatic Temperature Control (HVAC/ATC), Rearview Mirror (RR VW MIR), Cabin Compartment Node (CCN), Transfer Case Switch (T-CASE SW), RUN/ST, Multifunction Control Switch (MULTIFCTN SW), Tire Pressure Monitor (TPM), Glow Plug Module (GLW PLG MOD) — Export Diesel Only
M16		10 Amp Red	Occupant Restraint Controller/Occupant Classification Module (ORC/OCM)
M17		15 Amp Blue	Left Tail/License/Park Lamp (LT-TAIL/LIC/PRK LMP)
M18		15 Amp Blue	Right Tail/Park/Run Lamp (RT-TAIL/PRK/RUN LMP)
M19		25 Amp Natural	Auto Shut Down (ASD #1 and #2)
M20		15 Amp Blue	Cabin Compartment Node Interior Light (CCN INT LIGHT), Switch Bank (SW BANK), Steering Control Module (SCM)
M21		20 Amp Yellow	Auto Shut Down (ASD #3)
M22		10 Amp Red	Right Horn (RT HORN (HI/LOW)
M23		10 Amp Red	Left Horn (LT HORN (HI/LOW)
M24		25 Amp Natural	Rear Wiper (REAR WIPER)
M25		20 Amp Yellow	Fuel Pump (FUEL PUMP), Diesel Lift Pump (DSL LIFT PUMP) — Export Only
M26		10 Amp Red	Power Mirror Switch (PWR MIRR SW), Driver Window Switch (DRVR WIND SW)
M27		10 Amp Red	Ignition Switch (IGN SW), Window Module (WIN MOD)

# MAINTAINING YOUR VEHICLE

Cavity	Cartridge Fuse	Mini-Fuse	Description
M28		10 Amp Red	Next Generation Controller (NGC), Transmission Feed (TRANS FEED), J1962
M29		10 Amp Red	Occupant Classification Module (OCM)
M30		15 Amp Blue	Rear Wiper Module (RR WIPER MOD), Power Folding Mirror (PWR FOLD MIR)
M31		20 Amp Yellow	Back-Up Lamps (B/U LAMPS)
M32		10 Amp Red	Occupant Restraint Controller (ORC), TT EUROPE
M33		10 Amp Red	Next Generation Controller (NGC), Global Powertrain Engine Controller (GPEC)
M34		10 Amp Red	Park Assist (PRK ASST), Heater Ventilation, Air Conditioning Module (HVAC MOD), Headlamp Wash (HDLP WASH), Compass (COMPAS)
M35		10 Amp Red	Heated Mirrors
M36		20 Amp Yellow	Power Outlet #3 (BATT)
M37		10 Amp Red	Anti-Lock Brake System (ABS), Electronic Stability Program (ESP), Stop Lamp Switch (STP LP SW), Fuel Pump Rly Hi Control
M38		25 Amp Natural	Lock/Unlock Motors (LOCK/UNLOCK MTRS)

## TIRE PRESSURES

- Check the inflation pressure of each tire, including the spare tire, at least monthly and inflate to the recommended pressure for your vehicle.
- The tire pressures recommended for your vehicle are found on the “Tire and Loading Information” label located on the driver’s side door opening.

**NOTE:** Refer to the Owner’s Manual on the DVD for more information on the life of tires.

### WARNING!

Overloading of your tires is dangerous. Overloading can cause tire failure, affect vehicle handling, and increase your stopping distance. Use tires of the recommended load capacity for your vehicle. Never overload them.

# MAINTAINING YOUR VEHICLE

## WARNING!

Improperly inflated tires are dangerous and can cause accidents. Under-inflation is the leading cause of tire failure and may result in severe cracking, component separation, or “blow out”. Over-inflation reduces a tire’s ability to cushion shock. Objects on the road and chuck holes can cause damage that results in tire failure. Unequal tire pressures can cause steering problems. You could lose control of your vehicle. Over-inflated or under-inflated tires can affect vehicle handling and can fail suddenly, resulting in loss of vehicle control.

## WHEEL AND WHEEL TRIM CARE

- All wheels and wheel trim, especially aluminum and chrome plated wheels, should be cleaned regularly with a mild soap and water to prevent corrosion.
- To remove heavy soil and/or excessive brake dust, use MOPAR® Wheel Cleaner or equivalent or select a non-abrasive, non-acidic cleaner.

## CAUTION!

Do not use scouring pads, steel wool, a bristle brush, or metal polishes. Do not use oven cleaner. These products may damage the wheel's protective finish. Avoid automatic car washes that use acidic solutions or harsh brushes that may damage the wheel's protective finish. Only MOPAR® Wheel Cleaner or equivalent is recommended.

## EXTERIOR BULBS

LIGHT BULBS – Exterior	Bulb Number
Backup, Tail, Stop, Turn Lamp	3057K
Center High-Mounted Stop Lamp (CHMSL)	LED (*)
Fog Lamp – If Equipped	PSX24W
Front Park/Turn Signal	3157AK
Front Side Marker	168
Headlamp – Low Beam	9008 H13
License Lamp	168

\* CHMSL is not serviceable. It is a LED lamp. To replace the LED, the entire CHMSL assembly must be replaced.



# CONSUMER ASSISTANCE

## CHRYSLER GROUP LLC CUSTOMER CENTER

P.O. Box 21-8004

Auburn Hills, MI 48321-8004

Phone: 1-800-423-6343

## CHRYSLER CANADA INC. CUSTOMER CENTER

P.O. Box 1621

Windsor, Ontario N9A 4H6

Phone: 1-800-465-2001

## ASSISTANCE FOR THE HEARING IMPAIRED

- To assist customers who have hearing difficulties, the manufacturer has installed special TDD (Telecommunication Devices for the Deaf) equipment at its customer center. Any hearing or speech impaired customer, who has access to a TDD or a conventional teletypewriter (TTY) in the United States, can communicate with the manufacturer by dialing 1-800-380-CHRY. Canadian residents with hearing difficulties that require assistance can use the special needs relay service offered by Bell Canada. For TTY teletypewriter users, dial 711 and for Voice callers, dial 1-800-855-0511 to connect with a Bell Relay Service operator.

### WARNING!

Engine exhaust, some of its constituents, and certain vehicle components contain, or emit, chemicals known to the State of California to cause cancer and birth defects, or other reproductive harm. In addition, certain fluids contained in vehicles and certain products of component wear contain, or emit, chemicals known to the State of California to cause cancer and birth defects, or other reproductive harm.

## PUBLICATIONS ORDERING

- **If you are the first registered retail owner of your vehicle**, you may obtain a free printed copy of the Owner's Manual, Warranty Booklet or Radio Manuals on your DVD by calling 1-800-992-1997 (U.S.) or 1-800-387-1143 (Canada) or by contacting your dealer.
- Replacement User Guides or DVDs or, if you prefer, a printed copy of the Owner's Manual, Warranty Booklet or Radio Manuals may be purchased by visiting [www.techauthority.com](http://www.techauthority.com) or by calling 1-800-890-4038 (U.S.) or 1-800-387-1143 (Canada). Visa, Master Card, American Express and Discover orders are accepted. If you prefer mailing your order, please call the above numbers for an order form.

**NOTE:** A street address is required when ordering manuals (no P.O. Boxes).

### NOTE:

- The Owner's Manual and User Guide electronic files are also available on the Chrysler, Jeep and Dodge websites.
- Click on the "For Owners" tab, select "Owner/Service Manuals", then select your desired model year and vehicle from the drop down lists.

# CONSUMER ASSISTANCE

## REPORTING SAFETY DEFECTS IN THE 50 UNITED STATES AND WASHINGTON, D.C.

- If you believe that your vehicle has a defect that could cause a crash or cause injury or death, you should immediately inform the National Highway Traffic Safety Administration (NHTSA) in addition to notifying the manufacturer.
- If NHTSA receives similar complaints, it may open an investigation, and if it finds that a safety defect exists in a group of vehicles, it may order a recall and remedy campaign. However, NHTSA cannot become involved in individual problems between you, your authorized dealer, and the manufacturer.
- To contact NHTSA, you may either call the Auto Safety Hotline toll free at 1-888-327-4236 (TTY: 1-800-424-9153), or go to <http://www.safercar.gov>; or write to: Administrator, NHTSA, 1200 New Jersey Avenue, SE., West Building, Washington, D.C. 20590. You can also obtain other information about motor vehicle safety from <http://www.safercar.gov>.

### In Canada

- If you believe that your vehicle has a safety defect, you should contact the Customer Service Department immediately. Canadian customers who wish to report a safety defect to the Canadian government should write to: Transport Canada, Motor Vehicle Defect Investigations and Recalls, 2780 Sheffield Road, Ottawa, Ontario K1B 3V9.

## TIRE WARRANTY

### Tire Limited Warranty And Adjustment Policy

- When a tire is removed from service due to a covered warranty condition under a tire manufacturer's "Limited Warranty Program", you may be eligible for a free tire replacement or a comparable new tire on a "prorated basis".
- Certain conditions, such as irregular wear or tire damage due to road hazards, collision, improper inflation, intentional alteration, and misuse, are excluded from the Limited Warranty Program. The Limited Warranty Program expires when your tires either wear to a specified tread depth, and/or after a period of time from the date of purchase, as stated in the Tire Warranty on the DVD.

**NOTE: Refer to the Tire Warranty on the DVD for specific information relating to the manufacturer's limited warranty for the tires installed on your vehicle. If you have any questions regarding the limited tire warranty coverage, contact your local authorized dealer or your local authorized tire dealer.**

# CONSUMER ASSISTANCE

## Disclaimer:

- THE TIRE MANUFACTURER'S LIMITED WARRANTY PROGRAM, THE DETAILS OF WHICH CAN BE FOUND ON THE OWNERS MANUAL DVD, THE TIRE MANUFACTURER'S WEBSITE OR AT ANY AUTHORIZED SERVICE CENTER ARE IN LIEU OF ALL OTHER REMEDIES OR WARRANTIES, EXPRESS OR IMPLIED, ARISING BY LAW OR OTHERWISE, INCLUDING FITNESS FOR A PARTICULAR PURPOSE OR MERCHANTABILITY. THE TIRE MANUFACTURER EXPRESSLY DISCLAIMS LIABILITY FOR INDIRECT, SPECIAL, INCIDENTAL OR CONSEQUENTIAL DAMAGES, LOST PROFIT, LOSS OF BUSINESS, LOSS OF GOODWILL, LOSS OF REPUTATION, PUNITIVE OR ANY OTHER DAMAGE, COST OR LOSS OF ANY KIND. SOME STATES AND PROVINCES DO NOT ALLOW THE EXCLUSION OR LIMITATION OF INCIDENTAL OR CONSEQUENTIAL DAMAGES, SO THE ABOVE LIMITATION OR EXCLUSION MAY NOT APPLY TO YOU.

## WARNING!

NOTE: Refer to the Owner's Manual on the DVD for complete warning information that could prevent accidents, injuries and even deaths.

## WARNING!

Death, serious injury and/or property damage may result from:

- Tire failure due to impact damage and/or improper maintenance.

(Continued)

## WARNING! (Continued)

- Tires should be inspected regularly by a qualified technician for signs of damage, such as punctures, impacts, under-inflation or overloading.
- Progressive air loss may result from punctures, cuts, curbing, impacts or partial bead unseating.

Some fitment causes for air loss are:

- Incomplete bead seating.
- Bead tearing caused by a machine tool due to insufficient lubrication or improper adjustment.
- Leaking valve core or rubber valve components (these should be replaced when problems are detected and whenever tires are replaced).
- Tire failure due to improper repairs.
- See Rubber Manufacturer's Association (RMA) established repair procedures at [www.rma.org](http://www.rma.org) for information on proper repair procedures. Never perform a temporary repair or use an inner tube as a substitute for a proper repair. Only qualified persons should repair tires.
- Explosion of tire/rim assembly due to improper mounting.
- Only specially trained persons should mount tires.
- Failure to mount tires on approved rims.
- Failure to deflate single or dual assemblies completely before demounting.

# CONSUMER ASSISTANCE

## Using Lift Kits

- Use of lift kits with some vehicle/tire combinations can cause instability or loss of control. When changing tire sizes, always consult an installer for optimum rim width and carefully check vehicle/tire clearances.

## Check Your Tires For Damage

- Frequent (at least monthly) inspection of your tires for signs of damage, uneven tread wear and their general condition is important for safety. Impacts, penetrations, cracks, knots, bulges or air loss always require tire removal and expert inspection.

## Tire Service Life

- The service life of a tire is dependent upon varying factors including, but not limited to, your driving style, tire pressure and distance driven.

## WARNING!

Tires and the spare tire should be replaced after six years, regardless of the remaining tread. Failure to follow this warning can result in sudden tire failure. You could lose control and have an accident resulting in serious injury or death.

- Keep dismantled tires in a cool, dry place with as little exposure to the light as possible.
- Protect tires from contact with oil, grease, and gasoline.

**NOTE:** All tire warranties are made by the tire manufacturer. Tires are not covered under your Chrysler New Vehicle Limited Warranty.

# MOPAR ACCESSORIES

## MOPAR® ACCESSORIES

- The following highlights just some of the authentic Dodge Accessories by MOPAR® that have been engineered to customize your Dodge Nitro.
- To see the full line of accessories, stop by your Dodge dealer or visit MOPAR.com.

### CHROME:

- Mirror Covers
- Front Air Deflector
- Rock Rails
- Tubular Side Steps
- Fuel Door
- Body Side Moldings
- Front Fascia Accent

### EXTERIOR:

- Black Tubular Side Steps
- Sunroof Air Deflector
- Tail lamp Guards
- Wheels
- Side Window Air Deflectors
- Molded Running Boards
- Front End Cover
- Hitch Receiver
- Black Front Air Deflector
- Molded Splash Guards
- Rear Air Deflector

### INTERIOR:

- Premium Carpet Floor Mats
- Security Cover
- Door sill guards
- Slush Floor Mats
- Billet Aluminum Shift Knob
- Bright Pedal Kit
- Door Sill Guards
- Premium Carpet Cargo Mat
- Ambient Light Kit

### ELECTRONICS:

- Portable Navigation Systems
- Media Center 730N (RER Navigation Radio)
- iPod® Adapter
- Uconnect™ Web (WiFi)
- Remote Start
- Rear View Camera
- Rear Seat Video
- Heated Seats

### CARRIERS:

- Hitch-Mount Bike Carrier
- Roof Top Cargo Basket
- Sport Utility Bars
- Roof Top Ski and Snowboard Carrier
- Roof-Mount Bike Carrier
- Roof Box Cargo Carrier

iPod® is a registered trademark of Apple, Inc.

# NOTES

---

---

---

---

---

---

---

---

---

---

---

---

---

---

---

---

---

---

---

---

---

---

---

---

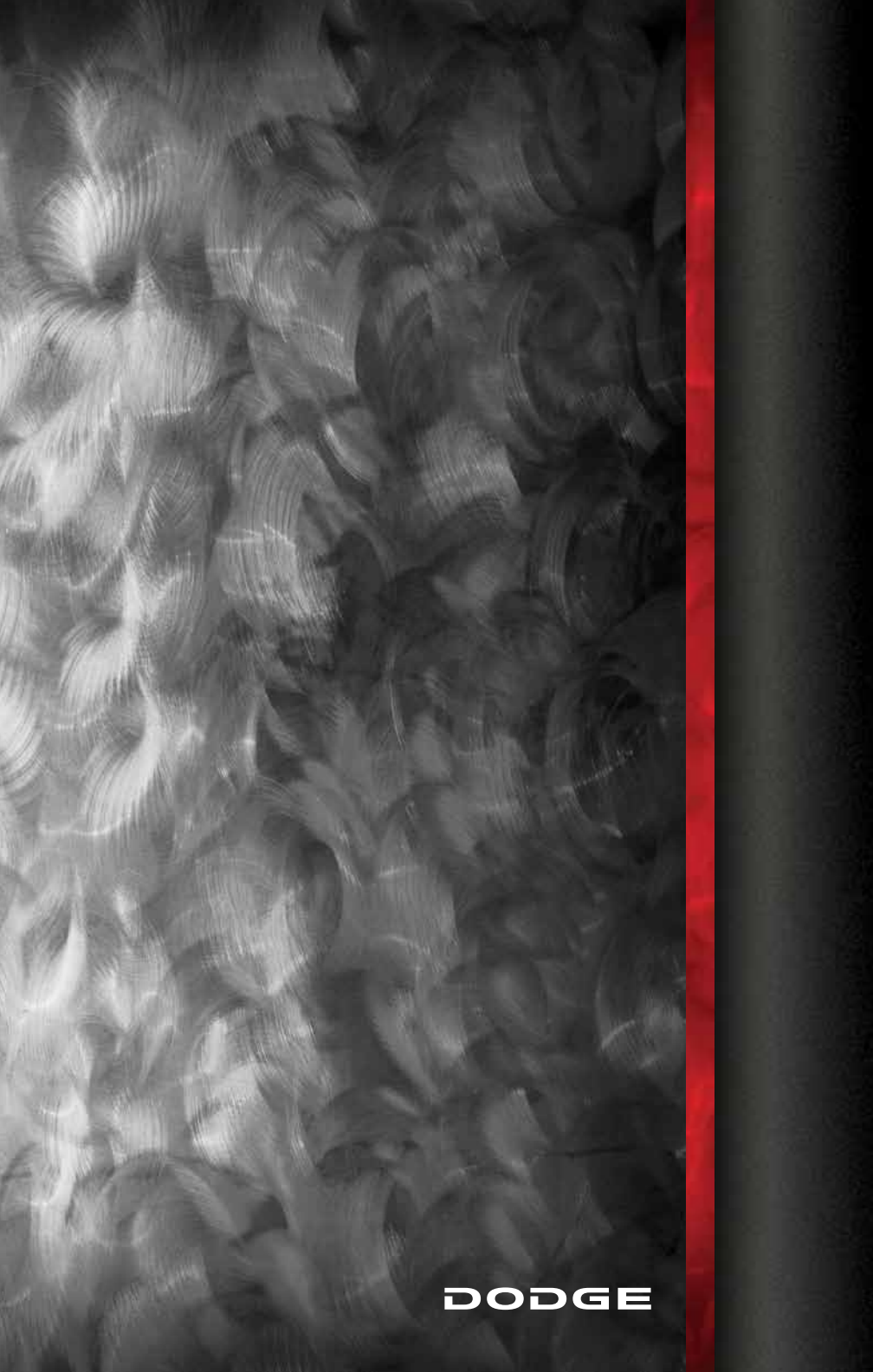

**DODGE**

# NITRO

## DODGE.com

This guide has been prepared to help you get quickly acquainted with your new Dodge and to provide a convenient reference source for common questions. However, it is not a substitute for your Owner's Manual.

For complete operational instructions, maintenance procedures and important safety messages, please consult your Owner's Manual, Navigation/Media Center Manuals and other Warning Labels in your vehicle.

Not all features shown in this guide may apply to your vehicle. For additional information on accessories to help personalize your vehicle, visit [www.mopar.com](http://www.mopar.com) or your local Dodge dealer.



10KA74-926-AA  
Nitro  
Third Printing  
User Guide