

**DODGE** 

---



2011

**USER GUIDE**

---

**NITRO**

The driver's primary responsibility is the safe operation of the vehicle. Driving while distracted can result in loss of vehicle control, resulting in a collision and personal injury. Chrysler Group LLC strongly recommends that the driver use extreme caution when using any device or feature that may take their attention off the road. Use of any electrical devices such as cell phones, computers, portable radios, vehicle navigation or other devices by the driver while the vehicle is moving is dangerous and could lead to a serious collision. Texting while driving is also dangerous and should never be done while the vehicle is moving. If you find yourself unable to devote your full attention to vehicle operation, pull off the road to a safe location and stop your vehicle. Some States or Provinces prohibit the use of cellular telephones or texting while driving. It is always the driver's responsibility to comply with all local laws.

**IMPORTANT:** This User Guide is intended to familiarize you with the important features of your vehicle. The DVD enclosed contains your Owner's Manual, Navigation/Media Center Manuals, Warranty Booklets, Tire Warranty and 24-Hour Towing Assistance (new vehicles purchased in the U.S.) or Roadside Assistance (new vehicles purchased in Canada) in electronic format. We hope you find it useful. If you are the first registered owner of your vehicle, you may obtain a printed copy of the Owner's Manual, Navigation/Media Center Manuals or Warranty Booklet by calling 1-800-423-6343 (U.S.) or 1-800-387-1143 (Canada) or by contacting your dealer. Replacement DVD kits may be purchased by visiting [www.techauthority.com](http://www.techauthority.com). Copyright 2010 Chrysler Group LLC.

# TABLE OF CONTENTS

## INTRODUCTION/WELCOME

Welcome From Chrysler Group LLC . . . . .	2
---	---

## CONTROLS AT A GLANCE

Driver Cockpit . . . . .	4
Instrument Cluster . . . . .	6

## GETTING STARTED

Key FOB . . . . .	8
Remote Start . . . . .	8
Theft Alarm . . . . .	9
Seat Belt . . . . .	9
Supplemental Restraint System (SRS) — Airbags . . . . .	10
Child Restraints . . . . .	11
Front Seats . . . . .	13
Rear Seats . . . . .	14
Heated Seats . . . . .	15
Tilt Steering Column . . . . .	16

## OPERATING YOUR VEHICLE

Turn Signal/Lights Lever . . . . .	17
Wiper/Washer Lever . . . . .	18
Speed Control Lever . . . . .	19
Manual Climate Controls . . . . .	20
Automatic Temperature Controls (ATC) . . . . .	20
ParkSense® Rear Park Assist . . . . .	21
Power Sunroof . . . . .	21
Wind Buffeting . . . . .	23

## ELECTRONICS

Your Vehicle's Sound System . . . . .	24
Non-Touch-Screen Radios . . . . .	26
Touch-Screen Radios . . . . .	29
Steering Wheel Audio Controls . . . . .	35
Uconnect™ Phone . . . . .	35
Uconnect™ Voice Command . . . . .	37
Electronic Vehicle Information Center (EVIC) . . . . .	38
Programmable Features . . . . .	39
Universal Garage Door Opener (HomeLink®) . . . . .	41
Power Outlet . . . . .	43

## OFF-ROAD CAPABILITIES

Four-Wheel Drive Operation . . . . .	44
--------------------------------------	----

## UTILITY

Cargo Area Features . . . . .	45
Trailer Towing Weights (Maximum Trailer Weight Ratings) . . . . .	46
Recreational Towing (Behind Motorhome, Etc.) . . . . .	47

## WHAT TO DO IN EMERGENCIES

24-Hour Towing Assistance . . . . .	48
Instrument Cluster Warning Lights . . . . .	48
If Your Engine Overheats . . . . .	52
Jacking And Tire Changing . . . . .	53
Jump-Starting . . . . .	56
Shift Lever Override . . . . .	58
Towing A Disabled Vehicle . . . . .	59
Freeing A Stuck Vehicle . . . . .	60
Event Data Recorder (EDR) . . . . .	61

## MAINTAINING YOUR VEHICLE

Opening The Hood . . . . .	62
Engine Compartment . . . . .	63
Fluids And Capacities . . . . .	65
Maintenance Chart . . . . .	67
Fuses . . . . .	70
Tire Pressures . . . . .	74
Wheel And Wheel Trim Care . . . . .	74
Exterior Bulbs . . . . .	75

## CONSUMER ASSISTANCE

Chrysler Group LLC Customer Center . . . . .	76
Chrysler Canada Inc. Customer Center . . . . .	76
Assistance For The Hearing Impaired . . . . .	76
Publications Ordering . . . . .	76
Reporting Safety Defects In The 50 United States And Washington, D.C. . . . .	77

## MOPAR ACCESSORIES

Authentic Accessories By MOPAR® . . . . .	78
---	----

## INDEX

. . . . .	79
-----------	----

# INTRODUCTION/WELCOME

## WELCOME FROM CHRYSLER GROUP LLC

Congratulations on selecting your new Chrysler Group LLC vehicle. Be assured that it represents precision workmanship, distinctive styling, and high quality - all essentials that are traditional to our vehicles.

Your new Chrysler Group LLC vehicle has characteristics to enhance the driver's control under some driving conditions. These are to assist the driver and are never a substitute for attentive driving. They can never take the driver's place. Always drive carefully.

Your new vehicle has many features for the comfort and convenience of you and your passengers. Some of these should not be used when driving because they take your eyes from the road or your attention from driving. Never text while driving or take your eyes more than momentarily off the road.

This guide illustrates and describes the operation of features and equipment that are either standard or optional on this vehicle. This guide may also include a description of features and equipment that are no longer available or were not ordered on this vehicle. Please disregard any features and equipment described in this guide that are not available on this vehicle. Chrysler Group LLC reserves the right to make changes in design and specifications and/or make additions to or improvements to its products without imposing any obligation upon itself to install them on products previously manufactured.

This User Guide has been prepared to help you quickly become acquainted with the important features of your vehicle. It contains most everything you will need to operate and maintain the vehicle, including emergency information.

The DVD includes a computer application containing detailed owner's information which can be viewed on a personal computer or MAC computer. The multimedia DVD also includes videos which can be played on any standard DVD player (including the Media Center Touch-Screen Radios). Additional DVD operational information is located on the back of the DVD sleeve.

For complete owner information, refer to your Owner's Manual on the DVD in the owner's kit provided at the time of new vehicle purchase. For your convenience, the information contained on the DVD may also be printed and saved for future reference.

Chrysler Group LLC is committed to protecting our environment and natural resources. By converting from paper to electronic delivery for the majority of the user information for your vehicle, together we greatly reduce the demand for tree-based products and lessen the stress on our environment.

### **Vehicles Sold In Canada**

With respect to any vehicles sold in Canada, the name Chrysler Group LLC shall be deemed to be deleted and the name Chrysler Canada Inc. used in substitution therefore.

# INTRODUCTION/WELCOME

## Rollover Warning

<b>⚠ WARNING: HIGHER ROLLOVER RISK</b>		
	<b>Avoid Abrupt Maneuvers and Excessive Speed.</b>  <b>Always Buckle Up.</b>  <b>See Owner's Manual For Further Information</b>	

### WARNING!

- Pedals that cannot move freely can cause loss of vehicle control and increase the risk of serious personal injury.
- Always make sure that objects cannot fall into the driver foot well while the vehicle is moving. Objects can become trapped under the brake pedal and accelerator pedal causing a loss of vehicle control.
- Failure to properly follow floor mat installation or mounting can cause interference with the brake pedal and accelerator pedal operation causing loss of control of the vehicle.
- Refer to your Owner's Manual on the DVD for further details.
- Never use the 'PARK' position as a substitute for the parking brake. Always apply the parking brake fully when parked to guard against vehicle movement and possible injury or damage.

### USE OF AFTERMARKET PRODUCTS (ELECTRONICS)

The use of aftermarket devices including cell phones, MP3 players, GPS systems, or chargers may affect the performance of on-board wireless features including Keyless Enter-N-Go and Remote Start range. If you are experiencing difficulties with any of your wireless features, try disconnecting your aftermarket devices to see if the situation improves. If your symptoms persist, please see an authorized dealer.

CHRYSLER, DODGE, JEEP, ATF+4, MOPAR and Uconnect are registered trademarks of Chrysler Group LLC.

**COPYRIGHT ©2010 CHRYSLER GROUP LLC**



# CONTROLS AT A GLANCE

## DRIVER COCKPIT

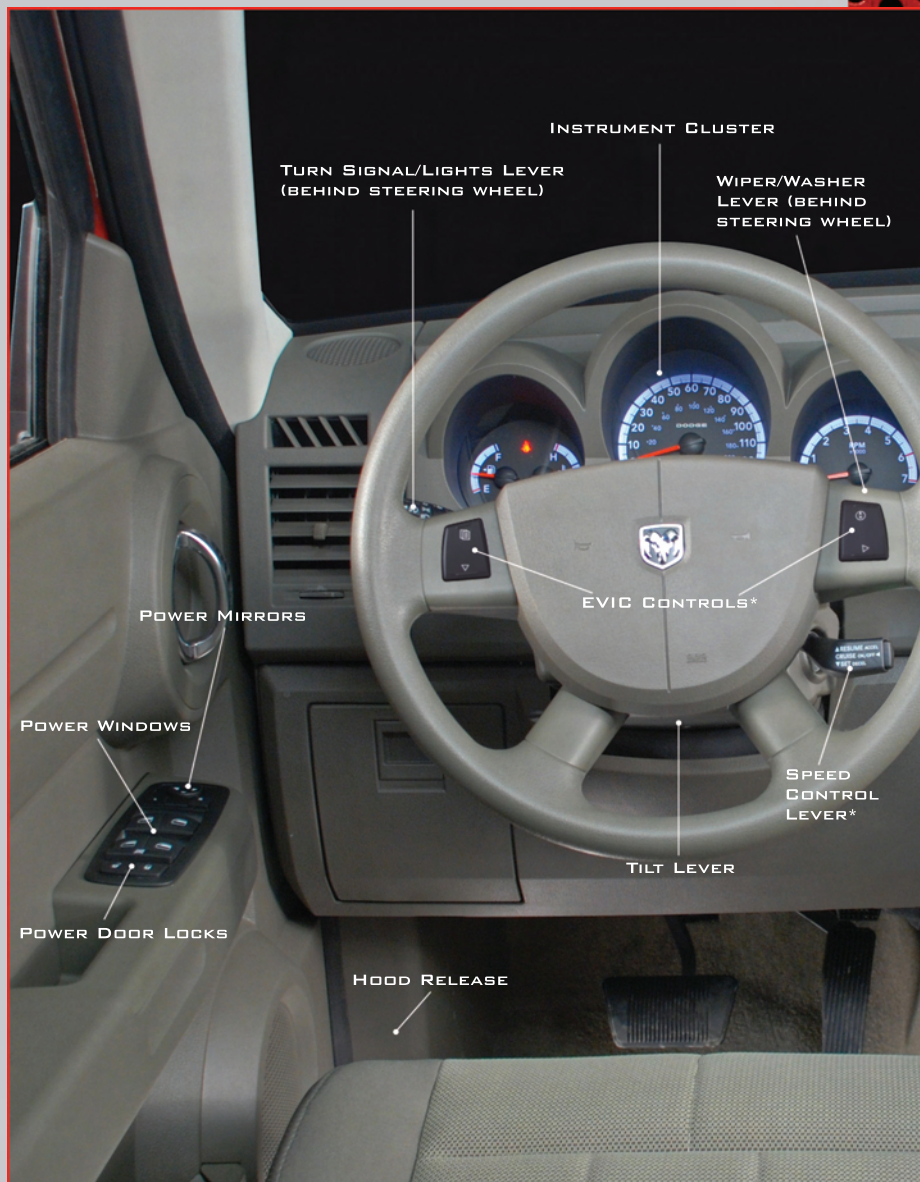

# CONTROLS AT A GLANCE

POWER OUTLET/  
CIGAR LIGHTER

AUDIO SYSTEM  
(NON-TOUCH-SCREEN RADIO SHOWN)

CLIMATE CONTROL

SWITCH PANEL  
HEATED SEATS\*  
ELECTRONIC STABILITY PROGRAM\*  
POWER INVERTER\*  
HAZARD SWITCH  
PARK ASSIST\*

TRANSMISSION GEAR SELECTOR

TRANSFER CASE SWITCH

PARK BRAKE LEVER













\*IF EQUIPPED

# CONTROLS AT A GLANCE



## INSTRUMENT CLUSTER

### Warning Lights

-  - Low Fuel Warning Light
-  - Charging System Light\*\*
-  - Oil Pressure Warning Light\*\*
-  - Anti-Lock Brake (ABS) Light\*\*
-  - Airbag Warning Light\*\*
-  - Electronic Throttle Control (ETC) Light
-  - Tire Pressure Monitoring System (TPMS) Light
-  - Engine Temperature Warning Light
-  - Transmission Temperature Warning Light
-  - Seat Belt Reminder Light
- BRAKE**
  -  - Brake Warning Light\*\*
  -  - Malfunction Indicator Light (MIL)\*\*
  -  - SERV (Service) 4WD Indicator Light







(See page 48 for more information.)



# CONTROLS AT A GLANCE



## Indicators

-  - Turn Signal Indicators
-  - High Beam Indicator
-  - Front Fog Light Indicator
-  - Vehicle Security Indicator\*
-  - TOW/HAUL Indicator
-  - 4WD LOW Indicator
-  - Electronic Stability Control (ESC) Activation/Malfunction Indicator Light
- CRUISE** - Cruise Indicator

## Odometer Messages

ECO - Fuel Saver Indicator Off  
ECO-ON - Fuel Saver Indicator On  
door - Door Ajar  
gASCAP - Fuel Cap Fault

LoWASH - Low Washer Fluid  
noFUSE\* - Fuse Fault  
CHAngE OIL\* - Change Engine Oil

\* If equipped

\*\* Bulb Check with Key On

# GETTING STARTED

## KEY FOB



### Locking And Unlocking The Doors/Liftgate

- Press the LOCK button once to lock all the doors and the liftgate. Press the UNLOCK button once to unlock the driver's door only and twice within five seconds to unlock all the doors and liftgate.
- All doors can be programmed to unlock on the first press of the UNLOCK button. Refer to Programmable Features in this guide.

### Panic Alarm

- Press the PANIC button once to turn the panic alarm on.
- Wait approximately three seconds and press the button a second time to turn the panic alarm off.

### Express Window Feature

- To remotely lower both front door windows at the same time, press and release the UNLOCK button and then immediately press and hold the UNLOCK button until the windows lower to the level desired or until they lower completely.

## WARNING!

Leaving unattended children in a vehicle is dangerous for a number of reasons. A child or others could be severely injured or killed. Children should be warned not to touch the parking brake, brake pedal, or the shift lever. Do not leave the key in the ignition. A child could operate power windows, other controls, or move the vehicle.

## REMOTE START

- Press the REMOTE START button  twice within five seconds. Pressing the REMOTE START button a third time shuts the engine off.
- To drive the vehicle, press the UNLOCK button, insert the key in the ignition and turn to the ON/RUN position.
- With remote start, the engine will only run for 15 minutes (timeout) unless the ignition key is placed in the ON/RUN position.
- The vehicle must be started with the key after two consecutive timeouts.

# GETTING STARTED

## WARNING!

- Do not start or run an engine in a closed garage or confined area. Exhaust gas contains Carbon Monoxide (CO) which is odorless and colorless. Carbon Monoxide is poisonous and can cause serious injury or death when inhaled.
- Keep Key Fob transmitters away from children. Operation of the Remote Start System, windows, door locks or other controls could cause serious injury or death.

## THEFT ALARM

### To Arm

- Press the Key Fob LOCK button or the power door lock switch while the door is open.

### To Disarm

- Press the Key Fob UNLOCK button and turn the ignition to the ON/RUN position.

## SEAT BELT

- Be sure everyone in your vehicle is in a seat and using a seat belt properly.
- Position the lap belt across your thighs, below your abdomen. To remove slack in the lap portion, pull up a bit on the shoulder belt. To loosen the lap belt if it is too tight, tilt the latch plate and pull on the lap belt. A snug belt reduces the risk of sliding under the belt in a collision.
- Position the shoulder belt on your chest so that it is comfortable and not resting on your neck. The retractor will withdraw any slack in the belt.
- A shoulder belt placed behind you will not protect you from injury during a collision. You are more likely to hit your head in a collision if you do not wear your shoulder belt. The lap and shoulder belt are meant to be used together.
- A belt that is too loose will not protect you properly. In a sudden stop you could move too far forward, increasing the possibility of injury. Wear your seat belt snugly.
- A frayed or torn belt could rip apart in a collision and leave you with no protection. Inspect the belt system periodically, checking for cuts, frays, or loose parts. Damaged parts must be replaced immediately. Do not disassemble or modify the system. Seat belt assemblies must be replaced after a collision if they have been damaged (bent retractor, torn webbing, etc.).
- The seat belts for both front seating positions are equipped with pretensioning devices that are designed to remove slack from the seat belt in the event of a collision.
- A deployed pretensioner or a deployed airbag must be replaced immediately.

# GETTING STARTED

## WARNING!

In a collision, you and your passengers can suffer much greater injuries if you are not buckled up properly. You can strike the interior of your vehicle or other passengers, or you can be thrown out of the vehicle. Always be sure you and others in your vehicle are buckled up properly.

## SUPPLEMENTAL RESTRAINT SYSTEM (SRS) — AIRBAGS

- This vehicle has Advanced Front Airbags for both the driver and right front passenger as a supplement to the seat belt restraint system. The Advanced Front Airbags will not deploy in every type of collision.
- Advanced Front Airbags are designed to provide additional protection by supplementing the seat belts in certain frontal collisions depending on the severity and type of collision. Advanced Front Airbags are not expected to reduce the risk of injury in rear, side, or rollover collisions.
- This vehicle is equipped with Supplemental Side Airbag Inflatable Curtains to protect the driver, front and rear passengers sitting next to a window.
- If the Airbag Warning Light  is not on during starting, stays on, or turns on while driving, have the vehicle serviced by an authorized service center immediately.
- Refer to the Owner's Manual on the DVD for further details regarding the Supplemental Restraint System (SRS).

## WARNING!

- Relying on the airbags alone could lead to more severe injuries in a collision. The airbags work with your seat belt to restrain you properly. In some collisions, the airbags won't deploy at all. Always wear your seat belts even though you have airbags.
- Being too close to the steering wheel or instrument panel during Advanced Front Airbag deployment could cause serious injury, including death. Airbags need room to inflate. Sit back, comfortably extending your arms to reach the steering wheel or instrument panel.
- Supplemental Side Airbag Inflatable Curtains need room to inflate. Do not lean against the door or window. Sit upright in the center of the seat.
- Being too close to the Supplemental Side Airbag Inflatable Curtain during deployment could cause you to be severely injured or killed.
- Do not drive your vehicle after the airbags have deployed. If you are involved in another collision, the airbags will not be in place to protect you.
- After any collision, the vehicle should be taken to an authorized dealer immediately.

# GETTING STARTED

## CHILD RESTRAINTS

- Children 12 years and under should ride properly buckled up in a rear seat, if available. According to crash statistics, children are safer when properly restrained in the rear seats rather than in the front.
- Every state in the United States and all Canadian provinces require that small children ride in proper restraint systems. This is the law, and you can be prosecuted for ignoring it.

### Installing The LATCH - Compatible Child Restraint System

- Your vehicle's second row passenger seats are equipped with the child restraint anchorage system called LATCH, which stands for Lower Anchors and Tether for Children.
- The rear outboard seating positions have lower anchors and all three rear seating positions have top tether anchors.
- Child seats with fixed lower attachments must be installed in the outboard positions only. Child seats with flexible lower attachments can be used in all three seating positions.
- **Never** install LATCH-compatible child seats such that two seats share a common lower anchorage.



- Loosen the child seat adjusters on the lower straps and tether straps so that you can attach the hook or connector to the lower and tether anchorages more easily.

- Attach the lower hooks or connectors over the top of the anchorage bars, pushing aside the seat cover material. The rear seat lower anchorages are round bars, located at the rear of the seat cushion where it meets the seatback. The rear seat lower anchors can be readily identified by the symbol  located on the seatback directly above the anchorages and are just visible when you lean into the rear seat to install the child restraint.
- The tether strap should be attached to the tether anchor on the rear of the seatback using the most direct path. For the outboard seating positions, route the tether underneath the head rest and attach the hook to the tether anchor located on the back of the seat.

# GETTING STARTED



- Tighten all three straps as you push the child restraint rearward and downward into the seat.

## Installing The Child Restraint Using The Vehicle Seat Belts

- To install a child restraint, first, pull enough of the seat belt webbing from the retractor to route it through the belt path of the child restraint and slide the latch plate into the buckle.
- Next, extract all the seat belt webbing out of the retractor and then allow the belt to retract into the retractor. Finally, pull on any excess webbing to tighten the lap portion around the child restraint. Any seat belt system will loosen with time, so check the belt occasionally, and pull it tight if necessary.
- Once you have completed securing the child restraint with the seat belt, secure the top tether strap. The tether strap should be attached to the tether anchor on the rear of the seatback using the most direct path. For the outboard seating positions, route the tether underneath the head rest and attach the hook to the tether anchor located on the back of the seat.

## WARNING!

- In a collision, an unrestrained child, even a tiny baby, can become a projectile inside the vehicle. The force required to hold even an infant on your lap could become so great that you could not hold the child, no matter how strong you are. The child and others could be severely injured or killed. Any child riding in your vehicle should be in a proper restraint for the child's size.
- Improper installation of a child restraint to the LATCH anchorages can lead to failure of an infant or child restraint. The child could be severely injured or killed. Follow the manufacturer's directions exactly when installing an infant or child restraint.
- An incorrectly anchored tether strap could lead to increased head motion and possible injury to the child. Use only the anchor positions directly behind the child seat to secure a child restraint top tether strap.
- Rearward-facing child seats must never be used in the front seat of a vehicle with a front passenger airbag. An airbag deployment could cause infants in this position to be severely injured or killed.

# GETTING STARTED

## FRONT SEATS

### Power Seat



- The power seat switch, located on the outboard side of the seat near the floor, controls forward/back, up/down, and tilt adjustment.

### Recliner

- Lift the recliner lever located on the outboard side of the seat, lean back and release at the desired position.

### Manual Seat Adjustment

#### Forward/Rearward



- Lift up on the adjusting bar located at the front of the seat near the floor and release at the desired position.

### Fold-Flat Front Passenger Seat



- The front passenger seat can be folded flat to allow for extended cargo space. Pull up on the recliner lever to fold down the seatback.

# GETTING STARTED

## CAUTION!

Do not place any article under a power seat or impede its ability to move as it may cause damage to the seat controls. Seat travel may become limited if movement is stopped by an obstruction in the seat's path.

## WARNING!

- Adjusting a seat while the vehicle is moving is dangerous. The sudden movement of the seat could cause you to lose control. The seat belt might not be properly adjusted, and you could be severely injured or killed. Only adjust a seat while the vehicle is parked.
- Do not ride with the seatback reclined so that the seat belt is no longer resting against your chest. In a collision, you could slide under the seat belt and be severely injured or killed. Use the recliner only when the vehicle is parked.

## REAR SEATS

### 60/40 Split Folding Rear Seat With Fold-Flat Feature

- Each rear seatback can be folded flat or reclined.

#### To Lower Rear Seatback

- With the front seats fully upright and positioned forward, pull the release strap toward the front of the vehicle and fold the rear seatback completely forward.
- Push down on the seatback to lock it in the folded position.



#### To Raise Rear Seatback

- Pull the release strap (toward the front of the vehicle).
- Raise the seatback and lock it into place.

#### Recliner Adjustment

- Pull the release strap while sitting in the rear seat to recline the seatback, release at the desired position.



# GETTING STARTED

## WARNING!

Be certain that the seatback is securely locked into position. If the seatback is not securely locked into position, the seat will not provide the proper stability for child seats and/or passengers. An improperly latched seat could cause serious injury.

## HEATED SEATS

### Front Heated Seats



- The controls for front heated seats are located near the bottom center of the instrument panel (below the heater/air conditioning controls).
- Press the switch once to select High-level heating. Press the switch a second time to select Low-level heating. Press the switch a third time to shut the heating elements Off.

## CAUTION!

Repeated overheating of the seat could damage the heating element and/or degrade the material of the seat.

## WARNING!

- Persons who are unable to feel pain to the skin because of advanced age, chronic illness, diabetes, spinal cord injury, medication, alcohol use, exhaustion or other physical conditions must exercise care when using the seat heater. It may cause burns even at low temperatures, especially if used for long periods of time.
- Do not place anything on the seat that insulates against heat, such as a blanket or cushion. This may cause the seat heater to overheat. Sitting in a seat that has been overheated could cause serious burns due to the increased surface temperature of the seat.

# GETTING STARTED

## TILT STEERING COLUMN



- The tilt lever is located on the steering column, below the turn signal lever.
- Push down on the lever to unlock the steering column.
- With one hand firmly on the steering wheel, move the steering column up or down as desired.
- Pull upward on the lever to lock the column firmly in place.

### **WARNING!**



Tilting the steering column while the vehicle is moving is dangerous. Without a stable steering column, you could lose control of the vehicle and have a collision. Adjust the column only while the vehicle is stopped. Be sure it is locked before driving.

# OPERATING YOUR VEHICLE

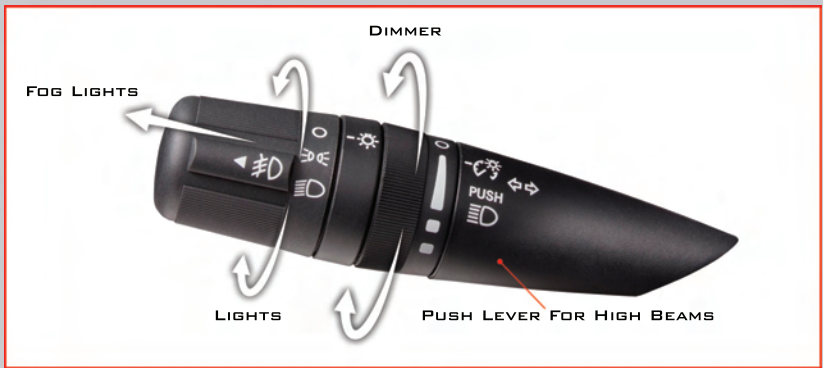
## TURN SIGNAL/LIGHTS LEVER



### Headlights/Parking Lights

- Rotate the end of the lever to the first detent for parking lights  and to the second detent for headlights .

### Instrument Panel Dimmer

- Rotate the center portion of the lever to the extreme bottom position to fully dim the instrument panel lights and prevent the interior lights from illuminating when a door is opened.
- Rotate the center portion of the lever up to increase the brightness of the instrument panel lights when the parking lights or headlights are on.
- Rotate the center portion of the lever upward to the next detent position to brighten the odometer and radio controls when the parking lights or headlights are on.
- Rotate the center portion of the lever upward to the last detent to turn on the interior lighting.

### Flash To Pass

- Pull the lever toward you to activate the high beams. The high beams will remain on until the lever is released.

### High Beam Operation

- Push the lever forward to activate the high beams.

**NOTE:** For safe driving, turn off the high beams when oncoming traffic is present to prevent headlight glare and as a courtesy to other motorists.

### Fog Lights

- Turn on the parking lights or low beam headlights and pull out the end of the lever.

# OPERATING YOUR VEHICLE

## Turn Signals/Lane Change Assist

- Tap the lever up or down once and the turn signal (right or left) will flash three times and automatically turn off.

## WIPER/WASHER LEVER



## Front Wipers

### Intermittent, Low And High Operation

- Rotate the end of the lever to the first detent position for one of five intermittent settings, the second detent for low wiper operation and the third detent for high wiper operation.

### Washer Operation

- Pull the lever toward you and hold for as long as spray is desired.

### Mist

- Pull down on the lever and release when a single wipe is desired.

## Rear Wiper

### Wiper Operation

- Rotate the center portion of the lever forward to the first detent for rear wiper operation.

### Washer Operation

- Rotate the center portion of the lever past the first detent to activate the rear washer.

# OPERATING YOUR VEHICLE

## SPEED CONTROL LEVER



### Cruise ON/OFF

- Push the ON/OFF button to activate the Speed Control.
- CRUISE will appear on the instrument cluster to indicate the Speed Control is on.
- Push the ON/OFF button a second time to turn the system off.

### Set

- With Speed Control on, push down and release the lever to set a desired speed.

### Accel/Decel

- Push and hold the lever up to accelerate or down to decelerate the vehicle; release the lever to save the new set speed.
- Once a speed is set, tapping the lever up or down will increase or decrease the set speed approximately 1 mph (2 km/h).
- Push and hold the lever up to accelerate in 5 mph (8 km/h) increments or push and hold the lever down to decelerate in 5 mph (8 km/h) increments; release the lever to save the new set speed.

### Resume

- To resume a previously selected speed in memory, push the lever up and release.

### Cancel

- Pull the lever toward you or apply the brakes to cancel the set speed and maintain the set speed in memory.
- Push the ON/OFF button to turn the system off and erase the set speed memory.

## WARNING!

- Leaving the Electronic Speed Control system on when not in use is dangerous. You could accidentally set the system or cause it to go faster than you want. You could lose control and have a collision. Always leave the Electronic Speed Control system off when you are not using it.
- Electronic Speed Control can be dangerous where the system cannot maintain a constant speed. Your vehicle could go too fast for the conditions, and you could lose control. A collision could be the result. Do not use Electronic Speed Control in heavy traffic or on roads that are winding, icy, snow-covered or slippery.

# OPERATING YOUR VEHICLE

## MANUAL CLIMATE CONTROLS



### Air Recirculation

- Use recirculation for maximum A/C operation.
- For window defogging, turn the recirculation button off.
- Recirculation is not allowed in defrost, floor, defrost/floor (mix) modes.

## AUTOMATIC TEMPERATURE CONTROLS (ATC)

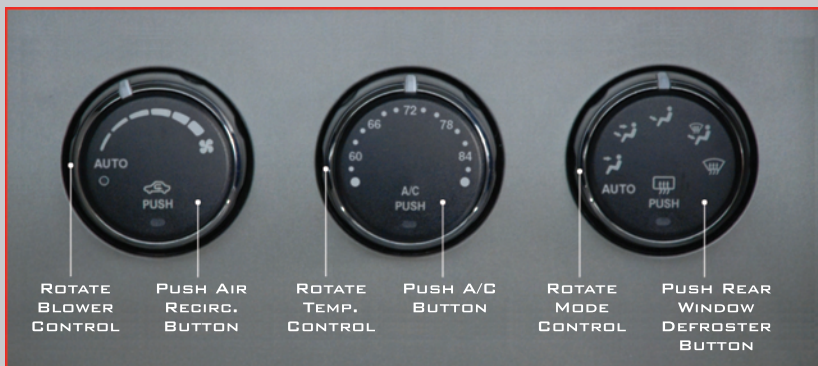

### Automatic Operation

- Turn the Mode and Blower Controls to the AUTO position.
- Select the desired temperature by rotating the Temperature Control.
- The system will maintain the set temperature automatically.

### Air Conditioning (A/C)

- If the air conditioning button is pressed while in the AUTO mode, the indicator light may flash three times to indicate the cabin air is being controlled automatically.

# OPERATING YOUR VEHICLE

## Air Recirculation

- Use recirculation for maximum A/C operation.
- For window defogging, turn the air recirculation button off.
- If the recirculation button is pressed while in the AUTO mode, the indicator light may flash three times to indicate the cabin air is being controlled automatically.

## PARKSENSE<sup>®</sup> REAR PARK ASSIST

- If an object is detected behind the rear bumper while the vehicle is in REVERSE, a warning will display in the instrument cluster and a chime will sound. The chime rate will change depending on the distance of the object, getting faster as the object gets closer to the bumper.
- When the Instrument Cluster reads either “Clean Sensor” or “Blinded”, clean off the bumper sensors to see if the condition is corrected.

## POWER SUNROOF

- The power sunroof switch is located on the overhead console.

### Opening Sunroof

#### Express

- Press the switch rearward and release. The sunroof will fully open and stop automatically.

### Closing Sunroof

#### Express

- Press the switch forward and release. The sunroof will close automatically from any position.

### Manual Open/Close

- Press and hold the switch rearward to open or forward to close the sunroof. Any release of the switch will stop the movement, and the sunroof will remain in a partially open or closed position until the switch is pressed again.

### Venting Sunroof

- Press and release the "VENT" button, and the sunroof will open to the vent position. This is called “Express Vent” and will occur regardless of sunroof position. During Express Vent operation, any movement of the switch will stop the sunroof.

### Pinch Protection Feature

- This feature will detect an obstruction in the opening of the sunroof during Express Close operation. If an obstruction in the path of the sunroof is detected, the sunroof will automatically return to the open position.

**NOTE:** Pinch protection is disabled while the switch is pressed and held during manual opening and closing of the sunroof.

# OPERATING YOUR VEHICLE

## WARNING!

- Never leave children in a vehicle with the key in the ignition switch. Occupants, particularly unattended children, can become entrapped by the power sunroof while operating the power sunroof switch. Such entrapment may result in serious injury or death.
- In a collision, there is a greater risk of being thrown from a vehicle with an open sunroof. You could also be severely injured or killed. Always fasten your seat belt properly and make sure all passengers are properly secured too.
- Do not allow small children to operate the sunroof. Never allow your fingers, other body parts, or any object to project through the sunroof opening. Injury may result.



# OPERATING YOUR VEHICLE

## WIND BUFFETING

- Wind buffeting can be described as a helicopter-type percussion sound. If buffeting occurs with the rear windows open, adjust the front and rear windows together.
- If buffeting occurs with the sunroof open, adjust the sunroof opening, or adjust any window. This will minimize buffeting.

# ELECTRONICS

## YOUR VEHICLE'S SOUND SYSTEM



STEERING WHEEL AUDIO  
CONTROLS (BACK OF  
STEERING WHEEL)

BLUETOOTH STREAMING  
AUDIO - ALLOWS YOU TO CONTROL  
YOUR BLUETOOTH DEVICE THROUGH  
THE RADIO, STEERING WHEEL AUDIO  
CONTROLS OR VOICE COMMANDS.  
SEE UCONNECT™ PHONE IN THIS  
SECTION FOR MORE DETAILS. FOR  
BLUETOOTH DEVICES SUPPORTING  
A2DP + AVCRP 1.3 PROTOCOL.

# ELECTRONICS



USB PORT ON RADIO - FOR COPYING FILES FROM A MEMORY STICK TO YOUR RADIO'S HARD DRIVE.

AUDIO JACK - WORKS WITH IPOD® DEVICES OR OTHER PLAYERS WITH A HEADPHONES JACK AND A 3.5MM CABLE.

YOUR RADIO SALES CODE

# ELECTRONICS

## NON-TOUCH-SCREEN RADIOS

### Media Center 130 (Sales Code RES)

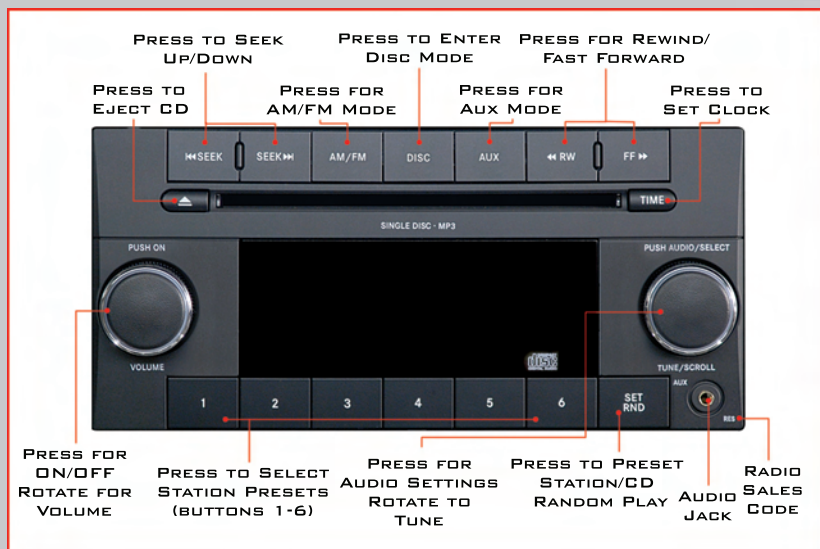

### Media Center 130 with Satellite Radio (Sales Code RES + RSC)

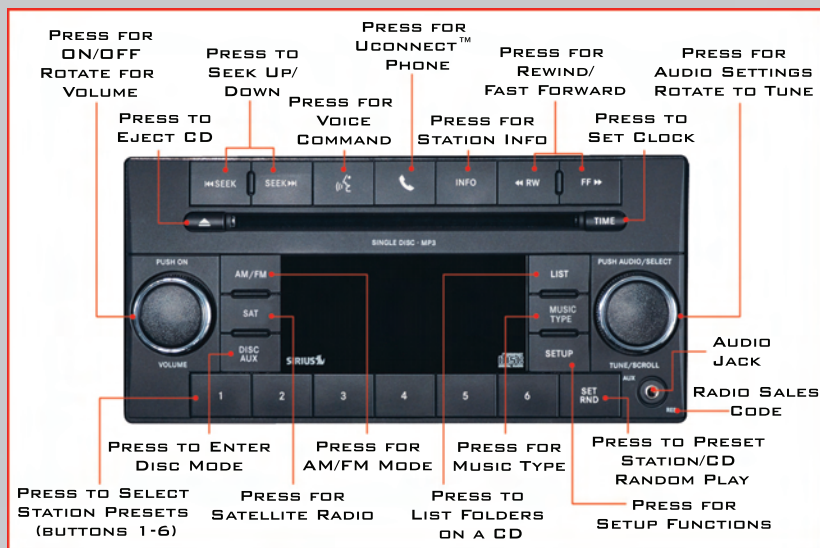

## Media Center 230 (Sales Code REQ)

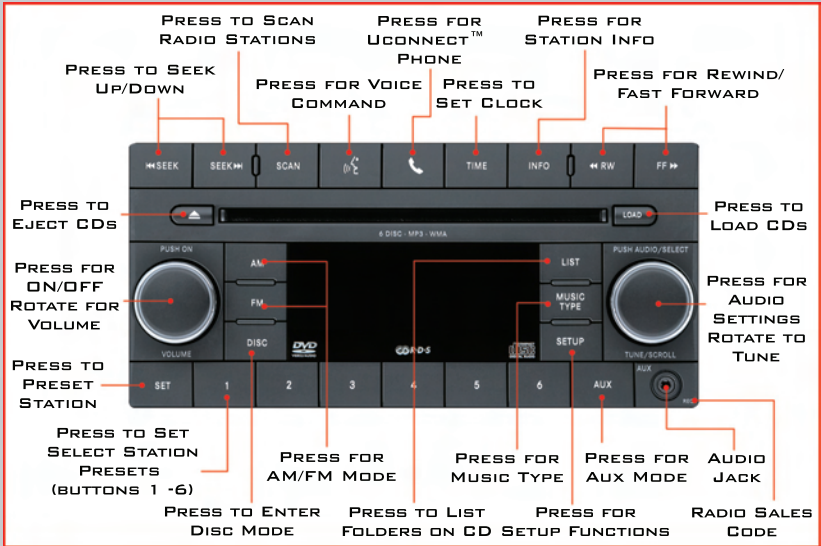

**NOTE:** Your radio may not be equipped with the Uconnect™ Voice Command and Uconnect™ Phone features. To determine if your radio has these features, press the Voice Command button on the radio. You will hear a voice prompt if you have the feature, or see a message on the radio stating “Uconnect Phone not available” if you do not.

- Your radio has many features that add to the comfort and convenience of you and your passengers. Some of these radio features should not be used when driving because they take your eyes from the road or your attention from driving.
- The radio sales code is located on the lower right side of the radio faceplate.

### Seek Up/Down Buttons

- Press to seek through radio stations in AM, FM, or SAT bands. Seek through tracks in CD mode.
- Hold either button to bypass stations without stopping.

### Audio Settings

- Press the TUNE/SCROLL control knob and BASS, MID, TREBLE, BALANCE and FADE will display. Rotate the TUNE/SCROLL control knob to select the desired setting.

# ELECTRONICS

## Audio Jack

- The Audio Jack allows a portable device, such as an MP3 player or a cassette player, to be plugged into the radio and utilize the vehicle's audio system, using a 3.5 mm audio cable, to amplify the source and play through the vehicle speakers.
- Pressing the AUX button will change the mode to auxiliary device if the Audio Jack is connected, allowing the music from your portable device to play through the vehicle's speakers.
- The functions of the portable device are controlled using the device buttons. The volume may be controlled using the radio or portable device.

## Clock Setting

- Press and hold the TIME button until the hours blink; turn the TUNE/SCROLL control knob to set the hours.
- Press the TUNE/SCROLL control knob until the minutes begin to blink; turn the TUNE/SCROLL control knob to set the minutes.
- Press the TUNE/SCROLL control knob to save the time change.
- To exit, press any button/knob or wait five seconds.

## Store Radio Presets

- Press the SET/RND button once and SET 1 will show in the display. Then select button (1–6).
- A second station may be added to each push button. Press the SET/RND button twice and SET 2 will show in the display, then select button (1–6).

## How To Load Multiple CDs/DVDs

### Media Center 230 (Sales Code REQ) Only

- Press the LOAD button and then press the button with the corresponding number (1–6) where the CD is being loaded. The radio will display PLEASE WAIT and prompt when to INSERT DISC.
- After the radio displays INSERT DISC, insert the CD into the player. The radio display will show LOADING DISC when the disc is loading and "READING DISC" when the radio is reading the disc.
- Press the eject button and then the corresponding number (1–6) to eject the desired disc.

## TOUCH-SCREEN RADIOS

### Media Center 730N CD/DVD/HDD/NAV (Sales Code RER)

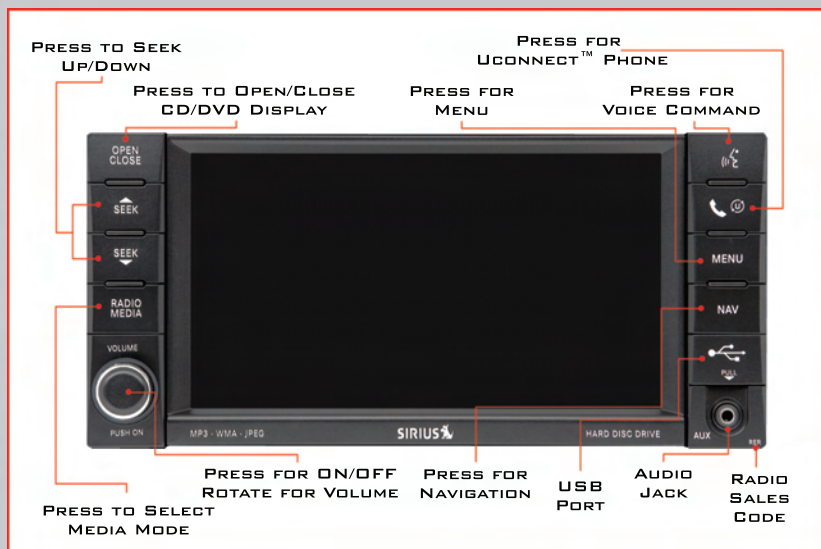

### Media Center 430/430N CD/DVD/HDD (Sales Code RBZ/RHB)

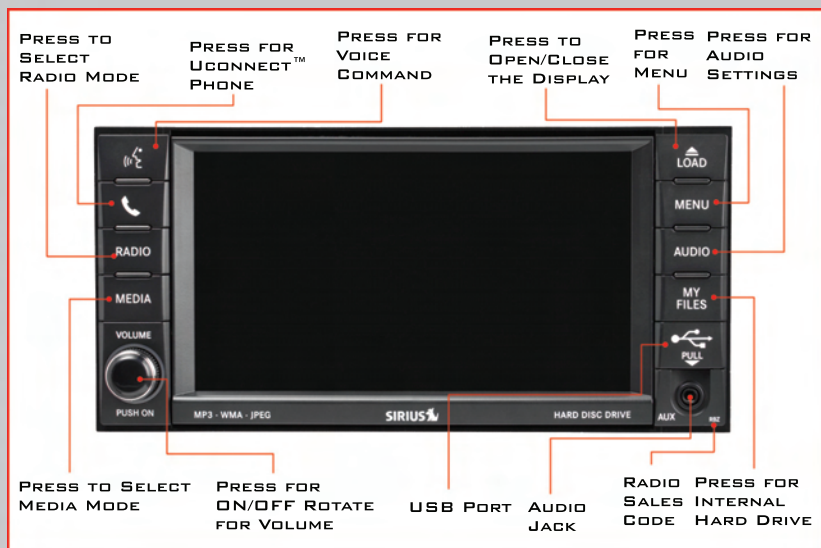

# ELECTRONICS

**NOTE:** Your radio may not be equipped with the Uconnect™ Voice Command and Uconnect™ Phone features. To determine if your radio has these features, press the Voice Command button on the radio. You will hear a voice prompt if you have the feature, or see a message on the radio stating “Uconnect Phone not available” if you do not.

- Your radio has many features that add to the comfort and convenience of you and your passengers. Some of these radio features should not be used when driving because they take your eyes from the road or your attention from driving.
- The radio sales code is located on the lower right side of the radio faceplate.

## Seek Up/Down

- Media Center 730N: Press the SEEK hard-key to seek through radio stations in AM, FM, or SAT bands. Seek through tracks in CD or iPod® modes or through songs in the HDD playlist.
- Media Center 430/430N: Press the SEEK up/down arrow soft-keys to change the currently playing station in AM, FM or SAT bands. Seek through tracks in CD or iPod® modes or through songs in the HDD playlist.

## Audio Jack

- The Audio Jack allows a portable device, such as an MP3 player or a cassette player, to be plugged into the radio and utilize the vehicle's audio system, using a 3.5 mm audio cable, to amplify the source and play through the vehicle speakers.
- Pressing the AUX button will change the mode to auxiliary device if the Audio Jack is connected, allowing the music from your portable device to be heard through the vehicle's speakers.
- The functions of the portable device are controlled using the device buttons. The volume may be controlled using the radio or portable device.

## Clock Setting

- Turn the radio on, then touch the screen where the time is displayed.
- Touch the USER CLOCK soft-key (Navigation radio only).
- To adjust the hours, touch either the HOUR FORWARD or HOUR BACKWARD soft-key.
- To adjust the minutes, touch either the MINUTE FORWARD or MINUTE BACKWARD soft-key.
- To save the new time setting, touch the screen where the word “Save” is displayed.

## Store Radio Presets

- Media Center 730N: Press the RADIO/MEDIA hard-key until AM FM SAT is displayed in the upper left corner of the screen.
- Media Center 430/430N: Press the RADIO hard-key to display AM FM SAT in the upper left corner of the screen.
- Select the radio band by touching either the AM, FM, or SAT soft-key.
- Find the station to store by either pressing the SEEK UP/DOWN hard-key (Media Center 730N), touching the right and left arrow soft-keys (Media Center 430/430N), touching the SCAN soft-key, or by using the DIRECT TUNE soft-key.



- Once the station is found, touch and hold one of the PRESET soft-keys in the list to the right, until you hear a confirmation beep.

## Hard Disk Drive Operation

### Copy Complete Audio Disc To Hard-Drive

- Media Center 730N: Press the OPEN/CLOSE hard-key.
- Media Center 430/430N: Press the LOAD hard-key.
- Insert a disc, then press the MENU hard-key.
- Touch the MY FILES soft-key, then select MY MUSIC.
- Touch the Add Music Files to HDD soft-key, then touch the From Disc soft-key in the next screen to start the process.

### Copying From USB

- The USB port on the radio face plate is for copying files to your hard drive. To access, lift up on the cover.
- Insert a USB device (e.g. thumb drive or memory stick), then select MY MUSIC.
- Touch the Add Music Files to HDD soft-key, then touch the From USB soft-key in the next screen.
- Select the folders or titles you would like to copy, then touch the DONE soft-key to start the copy process.

### Copy Pictures To The Hard-Drive

- Insert either a CD or a USB device containing your pictures in JPEG format into the USB port on the radio face.
- Touch the MY FILES soft-key, then go to the MANAGE MY FILES screen.
- Touch the MY PICTURES soft-key to get an overview of the currently stored images.
- Touch one of the ADD PICTURES soft-keys, then select the type of media inserted.
- Use the PAGE soft-keys to page through a list of pictures and press the picture you would like to import.
- Confirm your selection by touching the YES soft-key. The imported picture is now available in the MANAGE MY PICTURES screen.
- In order to display the imported picture in the radio screen, touch the desired picture soft-key.
- Select this picture by pressing the PICTURE VIEW soft-key. A check mark indicates the currently used picture.

## Cleaning Your Touch-Screen Radio

- Do not spray any liquid or caustic chemicals directly on the screen. Use a clean and dry micro fiber lens cleaning cloth in order to clean the touch-screen.
- If necessary, use a lint-free cloth dampened with a cleaning solution such as isopropyl alcohol or an isopropyl alcohol and water solution ratio of 50:50. Be sure to follow the solvent manufacturer's precautions and directions.

# ELECTRONICS

## Navigation – Media Center 730N (Sales Code RER) Only

- Navigation radios require digital data from a navigation database. The data in the navigation database is licensed from Navigation Technologies®. Not all roads are digitized.
- For software updates, visit <http://www.chrysler.com/owners> website, visit <http://www.navteq.com> website, or contact your authorized dealer for the latest available software.

**NOTE:** Many features of this radio are speed dependent. For your own safety, it is not possible to use the touch-screen keyboard to enter a name (e.g., street name) while the vehicle is in motion. Pull over at a safe location to complete your task or use Voice Command.

- The Navigation system receives GPS signals from satellites to display the position of your vehicle.

### New Destination

- Press the NAV hard-key to access the Navigation Main Menu.
- Touch the NEW DESTINATION soft-key to program a destination, then select the destination soft-key of your choice.
- Media Center 730N allows destinations to be input by voice while in motion. Press the Voice Command button on the radio to begin.

### Program/Storing Home Address

- Press the NAV hard-key to access the Navigation Main Menu.
- Touch the GUIDE ME HOME soft-key, then touch the STREET ADDRESS soft-key.
- Touch the STATE soft-key, then enter your state name into the speller; select your state from the list and press the CHANGE soft-key.
- Touch the INPUT STREET NAME soft-key and enter your street name into the speller.
- Touch the CONTINUE soft-key and enter your address into the speller; touch the CONTINUE soft-key again.
- Touch the city name and touch the SAVE soft-key to complete programming.

### Change Stored Home Address

- Press the MENU hard-key, then touch the MY FILES soft-key.
- Touch the MY ADDRESS BOOK soft-key, then touch the HOME soft-key.
- In the Home Address Information screen, touch the EDIT CONTACT soft-key, then touch the CHANGE ADDRESS soft-key in the next screen.
- Touch the INPUT STREET NAME soft-key and enter your street name into the speller.
- Touch the CONTINUE soft-key and enter your address into the speller; touch the CONTINUE soft-key again.
- Touch the city name and touch the SAVE soft-key to complete programming.

## Guide Me Home

- Press the NAV hard-key to access the Navigation Main Menu.
- Touch the GUIDE ME HOME soft-key to route you back to your home destination from your current location. Touch the GO soft-key to start your trip.

## Local Address Book Features

- Your navigation-equipped radio can store destinations into its local address book so that you can recall them later.
- To save your current location to the local address book, touch the cursor on the screen, next touch SELECT, then touch CURSOR POINT, next touch OPTIONS, then touch SAVE DESTINATION, and lastly touch ADDRESS BOOK.
- To add or delete destinations from your local address book stored on the radio, press the MENU hard key, then touch MY FILES, next touch ADDRESS BOOK, and last touch DEFAULT FOLDER (or any added folder).
- To route to a destination that is saved in your local address book, press the MENU hard key, then touch MY FILES, next touch ADDRESS BOOK, and last touch DEFAULT FOLDER and select the contact you want to route to.

## Map

- Press the NAV hard-key to access the Navigation Main Menu.
- Touch the MAP soft-key to display a map of your current position.

## Navigation – Media Center 430N (Sales Code RHB) Only

- For software updates, visit <http://www.garmin.com/chrysler> website, or contact your authorized dealer for the latest available software.
- The Navigation system receives GPS signals from satellites to display the position of your vehicle. You may experience interruptions or delays in receiving navigation information in garages, tunnels, large cities, or other situations where the vehicle does not have a direct line of sight to the sky.
- Voice Command is not available for navigation commands on this radio (although Voice Command functions for all other radio functions).

## Map

- Touch the NAV soft-key in the upper-right corner of your radio screen, to access the Navigation system.
- Touch the **View Map** soft-key to display a map of your current position.

## Entering a Destination/Finding a Point of Interest

- Touch the NAV soft-key in the upper-right corner of your radio screen, to access the Navigation system.
- Touch the **Where To?** soft-key to program a destination.
- Next touch one of the subcategories to search for your destination. Address, Points of Interest, Recently Found, Favorites and Intersection are a few of the options.
- After touching one of the subcategories, follow the on-screen steps to complete the process and be routed to your destination.

# ELECTRONICS

## Setting a Home Location

- Touch the NAV soft-key in the upper-right corner of your radio screen, to access the Navigation system.
- Touch the **Where To?** soft-key, then touch **Go Home**.
- Next, select from:
  - Enter My Address – enter an address for the location using the on-screen keyboard.
  - Use my current location – sets your current location as your Home Location.
  - Choose from Recently Found – select a location from your recently found locations.
- After you set your Home Location, touch **Where To?** , then touch **Go Home**.

## Editing Home Location

- Touch the NAV soft-key in the upper-right corner of your radio screen, to access the Navigation system.
- Touch the **Where To?** soft-key, then touch **Favorites**.
- Touch the location you want to edit.
- Next, touch **Press for More**.
- Touch **Edit**.
- Follow the on-screen steps for editing the Home Location.

## Go Home

- Touch the NAV soft-key in the upper-right corner of your radio screen, to access the Navigation system.
- Touch **Where To?** , then touch **Go Home**.

## STEERING WHEEL AUDIO CONTROLS



- The steering wheel audio controls are located on the rear surface of the steering wheel.

### Right Switch

- Press the switch up or down to increase or decrease the volume.
- Press the button in the center to change modes AM/FM/CD/SAT.

### Left Switch

- Press the switch up or down to search for the next listenable station or select the next or previous CD track.
- Press the button in the center to select the next preset station (radio) or to change CDs if equipped with a CD Changer.

## UCONNECT™ PHONE

- To determine if your vehicle is equipped with Uconnect™ Phone, press the Uconnect™ Phone button . If your vehicle has this feature, after a couple seconds you will hear a voice prompt. If not, you will see a message on the radio "Uconnect phone not available".
- The Uconnect™ Phone is a voice-activated, hands-free, in-vehicle communications system with Voice Command Capability (see Voice Command section).
- The Uconnect™ Phone allows you to dial a phone number with your mobile phone using simple voice commands.
- For vehicles equipped with Video Entertainment System (VES)™, refer to the Uconnect™ Phone section of the Uconnect™ User's Manual on the DVD for further details.
- For vehicles not equipped with VES™, refer to your vehicle Owner's Manual on the DVD for further details.

**NOTE:** The Uconnect™ Phone requires a mobile phone equipped with the Bluetooth® Hands-Free Profile, Version 0.96 or higher. For Uconnect™ customer support, call 1-877-855-8400 or visit [www.dodge.com/uconnect](http://www.dodge.com/uconnect).

# ELECTRONICS

## Phone Pairing

**NOTE:** Pairing is a one-time initial setup before using the phone. You will also need to follow the Bluetooth® instructions in your cell phone user guide to complete the phone pairing setup.

- Press the Phone button  to begin.
- Wait for the “ready” prompt and BEEP.
- (After the BEEP), say “Uconnect setup”.
- (After the BEEP), say “phone pairing”.
- (After the BEEP), say “pair a phone”.
- Follow the audible prompts.
- You will be asked to enter a four-digit Personal Identification Number (PIN), which you will later need to enter into your mobile phone. You can enter any four-digit PIN. You will not need to remember this PIN after the initial pairing process.
- You will then be prompted to give the phone pairing a name (each phone paired should have a unique name).
- Next you will be asked to give this new pairing a priority of 1 thru 7 (up to seven phones may be paired); 1 is the highest and 7 is the lowest priority. The system will only connect to the highest priority phone that exists within the proximity of the vehicle.



## Making A Phone Call

- Press the Phone button .
- (After the BEEP), say “dial” (or “call” a name).
- (After the BEEP), say number (or name).

## Phonebook Edit

- Press the Phone button .
- (After the BEEP), say “phonebook”.
- (After the BEEP), say “new entry” or “list names” or “delete”.
- Follow the prompts.

## Receiving A Call – Accept (And End)

- When an incoming call rings/is announced on Uconnect™, press the Phone button .
- To end a call, press the Phone button .

## Mute (Or Unmute) Microphone During Call

- During a call, press the Voice Command button  VR .
- (After the BEEP), say “mute” (or “mute off”).

## Transfer Ongoing Call Between Handset And Vehicle

- During a call, press the Voice Command button  VR .
- (After the BEEP), say “transfer call”.

## Changing The Volume



- Start a dialogue by pressing the Phone button , then adjust the volume during a normal call.
- Use the radio ON/OFF VOLUME rotary knob to adjust the volume to a comfortable level while the Uconnect™ system is speaking. Please note the volume setting for Uconnect™ is different than the audio system.

**NOTE:** To access the tutorial, press the Uconnect™ hard-key. After the BEEP, say “tutorial”. Press any hard-key/button or touch the display (Touch-Screen radio) to cancel the tutorial.

## WARNING!

- Any voice commanded system should be used only in safe driving conditions following local laws and phone use. All attention should be kept on the roadway ahead. Failure to do so may result in a collision causing you and others to be severely injured or killed.
- In an emergency, to use Uconnect™ Phone, your mobile phone must be:
  - turned on,
  - paired to Uconnect™ Phone,
  - and have network coverage.

## UCONNECT™ VOICE COMMAND

- The Uconnect™ Voice Command system allows you to control your AM, FM radio, satellite radio, disc player, Uconnect™ Phone, a memo recorder, and supported portable media devices.
- When you press the Voice Command button  VR located on the radio faceplate or steering wheel, you will hear a beep. The beep is your signal to give a command. If you do not say a command within a few seconds, the system will present you with a list of options. If you ever wish to interrupt the system while it lists options, press the Voice Command button  VR, listen for the BEEP, and say your command.

## Voice Command for Text Messaging

- If equipped with Uconnect™ Voice Command, your Media Center 430N radio may be able to play incoming SMS messages through the vehicle sound system.
- It also allows you to respond by selecting from various pre-defined phrases.
- Not all phones are compatible with this feature. Refer to the phone compatibility list at [www.dodge.com/uconnect](http://www.dodge.com/uconnect). Connected mobile phones must be bluetooth-compatible, and paired with your radio.

## Changing The Volume

- Start a dialogue by pressing the Voice Command button  VR, then say a command (for example, “tutorial”).

# ELECTRONICS

- Use the radio ON/OFF VOLUME rotary knob to adjust the volume to a comfortable level while the Voice Command system is speaking. The volume setting for Voice Command is different than the audio system.
- For vehicles equipped with Video Entertainment System (VES)<sup>™</sup>, refer to the Uconnect<sup>™</sup> Voice Command section of the Uconnect<sup>™</sup> User's Manual on the DVD for further details.
- For vehicles not equipped with VES<sup>™</sup>, refer to your vehicle Owner's Manual on the DVD for Uconnect<sup>™</sup> Voice Command information.

**NOTE:** To access the tutorial, press the Voice Command button  VR . After the BEEP, say "tutorial". Press any hard-key/button or touch the display (Touch-Screen radio) to cancel the tutorial.

## Bluetooth<sup>®</sup> Streaming Audio

- If equipped with Uconnect<sup>™</sup> Voice Command, your bluetooth-equipped iPod<sup>®</sup> devices, cellphones or other media players, may also be able to stream music to your vehicle's speakers. Your connected device must be bluetooth-compatible, and paired with your Media Center radio (see Uconnect<sup>™</sup> Phone for pairing instructions). Press the AUX button on the radio faceplate until "BT" is displayed on the radio screen.



## WARNING!

Any voice commanded system should be used only in safe driving conditions following local laws and phone use. All attention should be kept on the roadway ahead. Failure to do so may result in a collision causing you and others to be severely injured or killed.

## ELECTRONIC VEHICLE INFORMATION CENTER (EVIC)



- The EVIC features a driver interactive display that is located in the instrument cluster. Pressing the controls on the steering wheel allows the driver to select vehicle information and Personal Settings. For additional information, refer to Programmable Features in this guide.

- Press and release the MENU button  and the mode displayed will change between Compass/Temperature, Trip, System Status, and Personal settings.
- Press the SCROLL button  to scroll through sub menus (i.e., Trip Functions, Avg. Fuel Economy, DTE, Elapsed Time, and Units).



- Press and release the Compass/Temperature button  for instant access to the Compass/Temperature screens.
- Press the FUNCTION SELECT button  to RESET Trip Functions and change Personal Settings.

## Compass Calibration



- This compass is self-calibrating, which eliminates the need to set the compass manually. When the vehicle is new, the compass may appear erratic and the EVIC will display “CAL” until the compass is calibrated.
- You may also calibrate the compass by completing one or more 360 degree turns (in an area free from large metal or metallic objects) until the “CAL” message displayed in the EVIC turns off. The compass will now function normally.

## ECO

- The ECO message will appear in your EVIC display whenever you are driving in a fuel efficient manner.
- This feature allows you to monitor when you are driving in a fuel efficient manner, and it can be used to modify driving habits in order to increase fuel economy.

## PROGRAMMABLE FEATURES

### Electronic Vehicle Information Center (EVIC) – If Equipped

- The EVIC can be used to program the following Personal Settings. Press and release the MENU button  until Personal Settings displays, then press the SCROLL button  to scroll through the settings. Press the FUNCTION SELECT button  to change the setting.
  - Language
  - Auto Door Locks
  - Auto UNLK On Exit
  - RKE Unlock
  - Sound Horn With RKE Lock
  - Turn Headlamps On With Remote Key Unlock
  - Flash Lamp Lock
  - Headlamp Off Delay
  - Key-Off Power Delay
  - Display ECO
  - Display Units of Measure In

### Key Fob Programmable Features

- The following features may also be programmed by using the Key Fob transmitter or the ignition switch and driver's door lock switch.

**NOTE:** Pressing the LOCK button while you are inside the vehicle will activate the Vehicle Security Alarm. Opening a door with the Vehicle Security Alarm activated will cause the alarm to sound. Press the UNLOCK button to deactivate the Vehicle Security Alarm.

# ELECTRONICS

## Unlock On First Press

- To unlock either the driver's side, or all doors, on the first press of the UNLOCK button:
- Press and hold the LOCK button for at least 4 seconds, but no longer than 10 seconds. Then, press and hold the UNLOCK button while still holding the LOCK button.
- Release both buttons at the same time.

## Auto Unlock Doors On Exit

- To have all of the vehicle doors unlock when any door is opened:
- Enter your vehicle and close all the doors.
- Cycle the ignition switch between LOCK and ON and then back to LOCK four times, ending up in the LOCK position (do not start the engine).
- Press the power door UNLOCK switch to unlock the doors. A single chime will indicate that programming is complete.

## Auto Door Lock

- To have the doors lock automatically when the vehicle's speed exceeds 15 mph (24 km/h):
- Enter your vehicle and close all the doors.
- Cycle the ignition switch between LOCK and ON and then back to LOCK four times, ending up in the LOCK position (do not start the engine).
- Press the power door LOCK switch to lock the doors. A single chime will indicate that programming is complete.

## Sound Horn With Lock

- To turn the horn chirp on or off when the doors are locked:
- Press the LOCK button for at least 4 seconds, but no longer than 10 seconds. Then, press the PANIC button while still holding the LOCK button.
- Release both buttons at the same time.

## Flashing Lights With Lock

- The turn signal lights flashing, when the doors are locked or unlocked, feature can be turned on or off. To turn this feature on or off:
- Press and hold the UNLOCK button for at least 4 seconds, but no longer than 10 seconds. Then, press and hold the LOCK button while still holding the UNLOCK button.
- Release both buttons at the same time.

## UNIVERSAL GARAGE DOOR OPENER (HOMELINK<sup>®</sup>)



### Programming HomeLink<sup>®</sup>

#### Begin Programming

- The HomeLink<sup>®</sup> buttons are located in the sun visor.
  - Erase all channels before you begin programming by holding the two outside buttons for up to 20 seconds until the red indicator flashes.
  - Park your vehicle outside of the garage and turn the ignition switch to the ON/RUN position.
- Place the hand-held transmitter 1 to 3 in (3 to 8 cm) from the HomeLink<sup>®</sup> buttons while keeping the indicator light in view.
  - Simultaneously, press and hold both the chosen HomeLink<sup>®</sup> button and the hand-held transmitter button until the HomeLink<sup>®</sup> indicator flash rate changes from a slow to a rapidly blinking light, then release both the HomeLink<sup>®</sup> and the hand-held transmitter buttons. This may take up to 30 seconds, or longer in rare cases.
  - Press and hold the just-programmed HomeLink<sup>®</sup> button; if the indicator light stays on constantly, programming is complete and the garage door should open.

#### NOTE:

- Only use this transceiver with a garage door opener that has a “stop and reverse” feature as required by Federal safety standards. This includes most garage door opener models manufactured after 1982. Do not use a garage door opener without these safety features. Call toll-free 1-800-355-3515 or, on the Internet, at [www.HomeLink.com](http://www.HomeLink.com) for safety information or assistance.
- If you are having difficulty programming your HomeLink<sup>®</sup> and your garage door opener was manufactured after 1995, you may have a rolling code. Follow the steps below for Programming A Rolling Code System.

#### Programming A Rolling Code System

- At the garage door opener motor (in the garage), locate the “learn” or “programming” button. This can usually be found where the hanging antenna wire is attached to the garage door opener motor (it is NOT the button normally used to open and close the door).
- Firmly press and release the “learn” or “programming” button. The name and color of the button may vary by manufacturer. Within 30 seconds, return to the vehicle and press the programmed HomeLink<sup>®</sup> button twice (holding the button for two seconds each time). If the device is plugged in and activates, programming is complete.
- If the device does not activate, press the button a third time (for two seconds) to complete the programming.

# ELECTRONICS

## Using HomeLink®

- To operate, simply press and release the programmed HomeLink® button and the programmed device will operate.
- Refer to your Owner's Manual on the DVD for further details. If you have any problems programming HomeLink®, or require assistance, please call toll-free 1-800-355-3515 or, on the Internet, at [www.HomeLink.com](http://www.HomeLink.com).

### **WARNING!**

- Your motorized door or gate will open and close while you are programming the universal transceiver. Do not program the transceiver if people or pets are in the path of the door or gate.
- Do not run your vehicle in a closed garage or confined area while programming the transceiver. Exhaust gas from your vehicle contains Carbon Monoxide (CO) which is odorless and colorless. Carbon Monoxide is poisonous when inhaled and can cause you and others to be severely injured or killed.

## POWER OUTLET

- The power outlet is located on the instrument panel below the climate control and is powered when the ignition switch is in the ON/RUN position.
- The outlet can operate a conventional cigar lighter unit or power accessories designed for use with a standard power outlet adapter.

### NOTE:

- Do not exceed the maximum power of 160 Watts (13 Amps) at 12 Volts. If the 160 Watt (13 Amp) power rating is exceeded, the fuse protecting the system will need to be replaced.
- All accessories connected to the “battery” powered outlets should be removed or turned off when the vehicle is not in use to protect the battery against discharge.



# OFF-ROAD CAPABILITIES

## FOUR-WHEEL DRIVE OPERATION



### Operating Information/Precautions

- This is an electric shift transfer case and is operated by the transfer case control knob (located on the center console).
- The electronically shifted transfer case is designed to be driven in the two-wheel drive position (2WD) for normal street and highway conditions (dry, hard-surfaced roads).
- When additional traction is required, rotate the transfer case switch to the 4WD LOCK position to lock the front and rear driveshafts together and force the front and rear wheels to rotate at the same speed.

### 2WD To 4WD LOCK

- Shifts between 2WD and 4WD LOCK can be done with the vehicle stopped or in motion. With the vehicle in motion, the transfer case will engage/disengage faster if you momentarily release the accelerator pedal after turning the control knob.
- If the vehicle is stopped, the key must be in the ON/RUN position.
- Shifts can not be completed if the key is in the ACC position.

**NOTE:** Do not attempt to make a shift while only the front or rear wheels are spinning. Shifting while only the front or rear wheels are spinning can cause damage to the transfer case.

## CARGO AREA FEATURES

### Cargo Tie-Down Hooks

- The tie-downs located on the cargo area floor should be used to safely secure loads when the vehicle is moving.

### Cargo Load Floor



- The panel in the load floor is reversible for added utility. One side features a plastic lined tray which can hold a variety of items. The maximum load capacity of the load floor is 400 lbs (181 kg).

### WARNING!

- Cargo tie-downs are not safe anchors for a child seat tether strap. In a sudden stop or a collision, a tie-down could pull loose and allow the child seat to come loose. A child could be badly injured. Use only the anchors provided for child seat tethers.
- To help protect against personal injury, passengers should not be seated in the rear cargo area. The rear cargo space is intended for load carrying purposes only, not for passengers, who should sit in seats and use seat belts.

## TRAILER TOWING WEIGHTS (MAXIMUM TRAILER WEIGHT RATINGS)

Engine/Transmission	Model	Frontal Area	Max GTW (Gross Trailer Wt)	Tongue Wt. (See Note)
3.7L/Automatic	4x2	32 sq ft (2.97 sq m)	2,000 lbs (907 kg)	200 lbs (91 kg)
3.7L/Automatic	4x4	32 sq ft (2.97 sq m)	2,000 lbs (907 kg)	200 lbs (91 kg)
4.0L/Automatic	4x2	32 sq ft (2.97 sq m)	2,000 lbs (907 kg)	200 lbs (91 kg)
4.0L/Automatic	4x4	32 sq ft (2.97 sq m)	2,000 lbs (907 kg)	200 lbs (91 kg)

Refer to local laws for maximum trailer towing speeds.

**NOTE: The trailer tongue weight must be considered as part of the combined weight of occupants and cargo, and should never exceed the weight referenced on the Tire and Loading Information placard.**

### When Towing Trailers With Gross Trailer Weight (GTW) Between 3,500 Lbs (1 588 kg) And 5,000 Lbs (2 268 kg)

The following chart provides maximum trailer weight ratings towable for the following engine/transmission combinations, ONLY if using a weight distributing hitch.

Engine/Transmission	Model	Frontal Area	Max GTW (Gross Trailer Wt)	Tongue Wt. (See Note)
3.7L/Automatic w/Trailer Tow Package	4x2	64 sq ft (5.94 sq m)	5,000 lbs (2 268 kg)	500 lbs (227 kg)
3.7L/Automatic w/Trailer Tow Package	4x4	64 sq ft (5.94 sq m)	5,000 lbs (2 268 kg)	500 lbs (227 kg)
4.0L/Automatic w/Trailer Tow Package	4x2	64 sq ft (5.94 sq m)	5,000 lbs (2 268 kg)	500 lbs (227 kg)
4.0L/Automatic w/Trailer Tow Package	4x4	64 sq ft (5.94 sq m)	5,000 lbs (2 268 kg)	500 lbs (227 kg)

Refer to local laws for maximum trailer towing speeds.

**NOTE: The trailer tongue weight must be considered as part of the combined weight of occupants and cargo, and should never exceed the weight referenced on the Tire and Loading Information placard.**



## RECREATIONAL TOWING (BEHIND MOTORHOME, ETC.)

### Towing — Two-Wheel Drive Models

#### Recreational Towing (All Four Wheels On The Ground)

- Recreational towing is allowed ONLY if the driveshaft is removed. Towing with the rear wheels on the ground while the driveshaft is connected can result in severe transmission damage.
- The parking brake must be firmly engaged and the wheels chocked during driveshaft removal and installation. The parking brake must remain engaged unless the vehicle is securely and properly connected to the tow vehicle, or the driveshaft is completely reinstalled. See your authorized dealer for proper driveshaft removal and reinstallation procedures, including flange orientation/alignment, use of thread-locking compound, proper bolt torque specifications, etc.

**NOTE:** This vehicle may be towed on a flatbed or vehicle trailer provided all four wheels are OFF the ground.

### Towing — Four-Wheel Drive Or All-Wheel Drive Models

#### Recreational Towing (All Four Wheels On The Ground)

- Recreational towing is NOT allowed. These models do not have a NEUTRAL position in the transfer case.

**NOTE:** This vehicle may be towed on a flatbed or vehicle trailer provided all four wheels are OFF the ground.

- Refer to your Owner's Manual on the DVD for further details.

#### CAUTION!

Front or rear wheel lifts should not be used. Internal damage to the transmission or transfer case will occur if a front or rear wheel lift is used when recreational towing.

#### WARNING!

If the driveshaft is removed, the vehicle can roll even if the transmission is in PARK, which could cause serious injury or death.

# WHAT TO DO IN EMERGENCIES

## 24-HOUR TOWING ASSISTANCE

- Dial toll-free 1-800-521-2779 or 1-800-363-4869 for Canadian residents.
- Provide your name, vehicle identification number and license plate number.
- Provide your location, including telephone number, from which you are calling.
- Briefly describe the nature of the problem and answer a few simple questions.
- You will be given the name of the service provider and an estimated time of arrival. If you feel you are in an “unsafe situation”, please let us know. With your consent, we will contact local police or safety authorities.

## INSTRUMENT CLUSTER WARNING LIGHTS

### - Electronic Stability Program (ESP) Indicator Light

- If this indicator light flashes during acceleration, apply as little throttle as possible. While driving, ease up on the accelerator. Adapt your speed and driving to the prevailing road conditions. To improve the vehicle's traction when starting off in deep snow, sand or gravel, it may be desirable to switch the ESP system off.

### - Tire Pressure Monitoring System (TPMS) Light

- Each tire, including the spare (if provided), should be checked monthly, when cold and inflated to the inflation pressure recommended by the vehicle manufacturer on the vehicle placard or tire inflation pressure label. (If your vehicle has tires of a different size than the size indicated on the vehicle placard or tire inflation pressure label, you should determine the proper tire inflation pressure for those tires.)
- As an added safety feature, your vehicle has been equipped with a Tire Pressure Monitoring System (TPMS) that illuminates a low tire pressure telltale when one or more of your tires is significantly under-inflated. Accordingly, when the low tire pressure telltale illuminates, you should stop and check your tires as soon as possible, and inflate them to the proper pressure. Driving on a significantly under-inflated tire causes the tire to overheat and can lead to tire failure. Under-inflation also reduces fuel efficiency and tire tread life, and may affect the vehicle's handling and stopping ability.
- **IF THE LIGHT STARTS FLASHING INDICATING A LOW TIRE PRESSURE, ADJUST THE AIR PRESSURE IN THE LOW TIRE TO THE AIR PRESSURE SHOWN ON THE VEHICLE PLACARD OR TIRE INFLATION PRESSURE LABEL LOCATED ON THE DRIVER'S DOOR. NOTE: AFTER INFLATION, THE VEHICLE MAY NEED TO BE DRIVEN FOR 20 MINUTES BEFORE THE FLASHING LIGHT WILL TURN OFF.**
- Please note that the TPMS is not a substitute for proper tire maintenance, and it is the driver's responsibility to maintain correct tire pressure, even if under-inflation has not reached the level to trigger illumination of the TPMS low tire pressure telltale.

# WHAT TO DO IN EMERGENCIES

- Your vehicle has also been equipped with a TPMS malfunction indicator to indicate when the system is not operating properly. The TPMS malfunction indicator is combined with the low tire pressure telltale. When the system detects a malfunction, the telltale will flash for approximately one minute and then remain continuously illuminated. This sequence will continue each time the vehicle is restarted as long as the malfunction exists.
- When the malfunction indicator is illuminated, the system may not be able to detect or signal low tire pressure as intended. TPMS malfunctions may occur for a variety of reasons, including the installation of replacement or alternate tires or wheels on the vehicle that prevent the TPMS from functioning properly. Always check the TPMS malfunction telltale after replacing one or more tires or wheels on your vehicle, to ensure that the replacement or alternate tires and wheels allow the TPMS to continue to function properly.

## CAUTION!

The TPMS has been optimized for the original equipment tires and wheels. TPMS pressures and warning have been established for the tire size equipped on your vehicle. Undesirable system operation or sensor damage may result when using replacement equipment that is not of the same size, type, and/or style. Aftermarket wheels can cause sensor damage. Do not use tire sealant from a can, or balance beads if your vehicle is equipped with a TPMS, as damage to the sensors may result.

### - Engine Temperature Warning Light

- This light warns of an overheated engine condition.
- If the light turns on and a warning chime sounds while driving, safely pull over and stop the vehicle. If the A/C system is on, turn it off. Also, shift the transmission into NEUTRAL and idle the vehicle. If the temperature reading does not return to normal, turn the engine off immediately.
- We recommend that you do not operate the vehicle or engine damage will occur. Have the vehicle serviced immediately.

## WARNING!

A hot engine cooling system is dangerous. You or others could be badly burned by steam or boiling coolant. You may want to call an authorized service center for service if your vehicle overheats.

### **BRAKE** - Brake Warning Light

- The Brake Warning light illuminates when there is either a system malfunction or the parking brake is applied. If the light is on and the parking brake is not applied, it indicates a possible brake hydraulic malfunction, booster problem or an Anti-Lock Brake System problem.
- We recommend you drive to the nearest service center and have the vehicle serviced immediately.

# WHAT TO DO IN EMERGENCIES

## WARNING!

Driving a vehicle with the red brake light on is dangerous. Part of the brake system may have failed. It will take longer to stop the vehicle. You could have a collision. Have the vehicle checked immediately.

### - Malfunction Indicator Light (MIL)

- Certain conditions, such as a loose or missing gas cap, poor fuel quality, etc., may illuminate the MIL after engine start. The vehicle should be serviced if the light stays on through several typical driving cycles. In most situations, the vehicle will drive normally and not require towing.
- If the MIL flashes when the engine is running, serious conditions may exist that could lead to immediate loss of power or severe catalytic converter damage. We recommend you do not operate the vehicle. Have the vehicle serviced immediately.

### **ESP** **BAS** - Electronic Stability Program (ESP) Indicator Light/Brake Assist System (BAS)

#### Warning Light

- If the ESP/BAS warning light comes on continuously with the engine running, a malfunction has been detected.
- If this light remains on after several ignition cycles, and the vehicle has been driven several miles (kilometers) at speeds greater than 30 mph (48 km/h), we recommend you drive to the nearest service center and have the vehicle serviced immediately.

### - Charging System Light

- This light shows the status of the electrical charging system. If the charging system light remains on, it means that the vehicle is experiencing a problem with the charging system.
- We recommend you do not continue driving if the charging system light is on. Have the vehicle serviced immediately.

### - Oil Pressure Warning Light

- This light indicates low engine oil pressure. If the light turns on while driving, stop the vehicle and shut off the engine as soon as possible. A chime will sound for four minutes when this light turns on.
- We recommend you do not operate the vehicle or engine damage will occur. Have the vehicle serviced immediately.

### - Anti-Lock Brake (ABS) Light

- This light monitors the Anti-Lock Brake System (ABS).
- If the light is not on during starting, stays on, or turns on while driving, we recommend you drive to the nearest service center and have the vehicle serviced immediately.

# WHAT TO DO IN EMERGENCIES

## - Electronic Throttle Control (ETC) Light

- This light informs you of a problem with the Electronic Throttle Control (ETC) system.
- If a problem is detected, the light will come on while the engine is running. Cycle the ignition when the vehicle has completely stopped and the shift lever is placed in the PARK position; the light should turn off.
- If the light remains lit with the engine running, your vehicle will usually be drivable; however, see an authorized service center immediately. If the light is flashing when the engine is running, immediate service is required and you may experience reduced performance, an elevated/rough idle or engine stall and your vehicle may require towing.

## - Airbag Warning Light

- If the light is not on during starting, stays on, or turns on while driving, have the vehicle serviced by an authorized service center immediately.

## - SERV (Service) 4WD Indicator Light

- If the light stays on or comes on during driving, it means that the 4WD system is not functioning properly and that service is required. We recommend you drive to the nearest service center and have the vehicle serviced immediately.

## - Transmission Temperature Warning Light

- This light indicates that there is excessive transmission fluid temperature that might occur with severe usage such as trailer towing. If this light turns on, stop the vehicle and run the engine at idle, with the transmission in NEUTRAL, until the light turns off. Once the light turns off, you may continue to drive normally.

## Fuel Cap/Loose Gas Cap Message

- If a “gas cap” message (shown as gASCAP) appears, tighten the gas cap until a “clicking” sound is heard.
- Press the odometer reset button to turn the message off.
- If the message continues to appear for more than three days after tightening the gas cap, see your authorized service center.

## Oil Change Indicator Message

- If an “oil change” message (shown as CHAngE OIL) appears and a single chime sounds, it is time for your next required oil change.

### Resetting The Light After Servicing

- Turn the ignition switch to the ON/RUN position (do not start engine).
- Fully depress the accelerator pedal three times within 10 seconds.
- Turn the ignition switch to the OFF/LOCK position.

# WHAT TO DO IN EMERGENCIES

## IF YOUR ENGINE OVERHEATS

- In any of the following situations, you can reduce the potential for overheating by taking the appropriate action.
  - On the highways — slow down.
  - In city traffic — while stopped, shift transmission into NEUTRAL, but do not increase engine idle speed.

**NOTE:** There are steps that you can take to slow down an impending overheat condition:

- If your air conditioner (A/C) is on, turn it off. The A/C system adds heat to the engine cooling system and turning the A/C off can help remove this heat.
- You can also turn the Temperature Control to maximum heat, the Mode Control to floor and the Fan Control to high. This allows the heater core to act as a supplement to the radiator and aids in removing heat from the engine cooling system.
- If the temperature reading does not return to normal, turn the engine off immediately.
- We recommend that you do not operate the vehicle or engine damage will occur. Have the vehicle serviced immediately.

### CAUTION!

Driving with a hot cooling system could damage your vehicle. If the temperature gauge reads HOT (H), pull over and stop the vehicle. Idle the vehicle with the air conditioner turned off until the pointer drops back into the normal range. If the pointer remains on HOT (H), and you hear continuous chimes, turn the engine off immediately and call for service.

### WARNING!

You or others can be badly burned by hot engine coolant (antifreeze) or steam from your radiator. If you see or hear steam coming from under the hood, do not open the hood until the radiator has had time to cool. Never try to open a cooling system pressure cap when the radiator or coolant bottle is hot.

# WHAT TO DO IN EMERGENCIES

## JACKING AND TIRE CHANGING

### Jack Location



- The scissor-type jack and tire changing tools are located in the left rear trim panel behind the second row seat.

### Spare Tire Stowage

- To remove the spare tire, remove the jack-handle components from the storage bin in the left rear trim panel and assemble them.
- Lower the spare tire by turning the winch drive nut, located in the rear cargo area inside the vehicle, counterclockwise with the jack-handle assembly until the spare tire is on the ground with enough cable slack to allow you to pull the spare tire out from underneath the vehicle.
- When the spare is clear, tilt the retainer at the end of the cable and pull it through the center of the wheel.

### Preparations For Jacking

- Park on a firm, level surface. Avoid ice or slippery areas.
- Set the parking brake and shift the automatic transmission into PARK.
- Turn the ignition to LOCK and turn on the Hazard Warning flasher.



- Block both the front and rear of the wheel diagonally opposite of the jacking position. For example, if changing the right front tire, block the left rear wheel.

**NOTE:** Passengers should not remain in the vehicle when the vehicle is being jacked.

# WHAT TO DO IN EMERGENCIES

## Jacking And Tire Changing Instructions

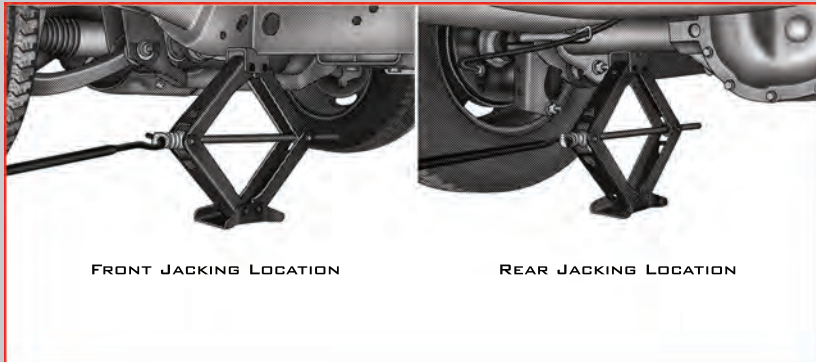

- Remove the spare tire, jack and tools from the stored location.
- Loosen (but do not remove) the wheel lug nuts by turning them counterclockwise one turn while the wheel is still on the ground.
- Assemble the jack and jacking tools. Connect the jack handle driver to the extension, then to the lug wrench.
- Locate the jack:
  - For the front tires, place it (rearward) of the notch on the body weld seam behind the wheel to be changed.
  - For the rear tires, place it under the axle by the wheel to be changed.
- Raise the vehicle by turning the jack screw clockwise. Raise the vehicle only until the tire just clears the surface and enough clearance is obtained to install the spare tire.
- Remove the lug nuts, wheel cover (if equipped) and the wheel.
- Position the spare wheel/tire on the vehicle and install the lug nuts with the cone-shaped end toward the wheel. Do NOT attempt to install a center cap or wheel cover on the compact spare. Lightly tighten the lug nuts clockwise. To avoid the risk of forcing the vehicle off the jack, do not tighten the nuts fully until the vehicle has been lowered.
- Lower the vehicle by turning the jack screw counterclockwise, and remove the jack and wheel blocks.
- Finish tightening the lug nuts. Push down on the wrench while tightening for increased leverage. Alternate nuts until each one has been tightened twice. The correct wheel nut tightness is 95 ft lbs (130 N•m). If in doubt about the correct tightness, have them checked with a torque wrench by your authorized dealer or at a service station.
- Secure the tire, jack, and tools in their proper locations.



# WHAT TO DO IN EMERGENCIES

## WARNING!

- Do not attempt to change a tire on the side of the vehicle close to moving traffic. Pull far enough off the road to avoid the danger of being hit when operating the jack or changing the wheel.
- Getting under a jacked-up vehicle is dangerous. The vehicle could slip off the jack and fall on you. You could be crushed. Never get any part of your body under a vehicle that is on a jack. If you need to get under a raised vehicle, take it to a service center where it can be raised on a lift.
- The jack is designed to use as a tool for changing tires only. The jack should not be used to lift the vehicle for service purposes. The vehicle should be jacked on a firm, level surface only. Avoid ice or slippery areas.
- If it is necessary to retrieve the spare tire from under the vehicle on the side of the vehicle close to moving traffic, pull far enough off the road to avoid the danger of being hit.
- Carefully follow these tire changing procedures to help prevent personal injury or damage to your vehicle: Always park on a firm, level surface as far from the edge of the roadway as possible before raising the vehicle.
- Raising the vehicle higher than necessary can make the vehicle less stable and could cause it to slip off the jack and hurt someone near it. Raise the vehicle only enough to remove the tire.
- A loose tire or jack, thrown forward in a collision or hard stop, could endanger the occupants of the vehicle. Always stow the jack parts and the spare tire in the places provided.

# WHAT TO DO IN EMERGENCIES

## JUMP-STARTING



- If your vehicle has a discharged battery it can be jumpstarted using a set of jumper cables and a battery in another vehicle or by using a portable battery booster pack.
- Jump-starting can be dangerous if done improperly so please follow the procedures in this section carefully.

**NOTE:** When using a portable battery booster pack follow the manufacturer's operating instructions and precautions.

### Preparations for Jump-Start

- The battery in your vehicle is located in the front of the engine compartment, behind the left headlight assembly.

**NOTE:** The positive battery post is covered with a protective cap. Lift up on the cap to gain access to the positive battery post.

- Set the parking brake, shift the automatic transmission into PARK and turn the ignition to LOCK.
- Turn off the heater, radio, and all unnecessary electrical accessories.
- If using another vehicle to jump-start the battery, park the vehicle within the jumper cables reach, set the parking brake and make sure the ignition is OFF.

### Jump-Starting Procedure

- Connect the positive (+) end of the jumper cable to the positive (+) post of the discharged vehicle.
- Connect the opposite end of the positive (+) jumper cable to the positive (+) post of the booster battery.

# WHAT TO DO IN EMERGENCIES

- Connect the negative end (-) of the jumper cable to the negative (-) post of the booster battery.
- Connect the opposite end of the negative (-) jumper cable to a good engine ground (exposed metal part of the discharged vehicle's engine) away from the battery and the fuel injection system.
- Start the engine in the vehicle that has the booster battery, let the engine idle a few minutes, and then start the engine in the vehicle with the discharged battery. Once the engine is started, remove the jumper cables in the reverse sequence:
- Disconnect the negative (-) jumper cable from the engine ground of the vehicle with the discharged battery.
- Disconnect the negative end (-) of the jumper cable from the negative (-) post of the booster battery.
- Disconnect the opposite end of the positive (+) jumper cable from the positive (+) post of the booster battery.
- Disconnect the positive (+) end of the jumper cable from the positive (+) post of the discharged vehicle.
- If frequent jump-starting is required to start your vehicle you should have the battery and charging system inspected at your authorized dealer.

## CAUTION!

- Do not use a portable battery booster pack or any other booster source with a system voltage greater than 12 Volts or damage to the battery, starter motor, alternator or electrical system may occur.
- Failure to follow these procedures could result in damage to the charging system of the booster vehicle or the discharged vehicle.
- Accessories that can be plugged into the vehicle power outlets draw power from the vehicle's battery, even when not in use (i.e., cellular phones, etc.). Eventually, if plugged in long enough, the vehicle's battery will discharge sufficiently to degrade battery life and/or prevent the engine from starting.

## WARNING!

- When temperatures are below the freezing point, electrolyte in a discharged battery may freeze. Do not attempt jump-starting because the battery could rupture or explode and cause personal injury. Battery temperature must be brought above the freezing point before attempting a jump-start.
- Take care to avoid the radiator cooling fan whenever the hood is raised. It can start anytime the ignition switch is on. You can be injured by moving fan blades.
- Remove any metal jewelry, such as watch bands or bracelets, that might make an inadvertent electrical contact. You could be severely injured.

*(Continued)*

# WHAT TO DO IN EMERGENCIES

## WARNING! *(Continued)*

- Batteries contain sulfuric acid that can burn your skin or eyes and generate hydrogen gas which is flammable and explosive. Keep open flames or sparks away from the battery.
- Do not allow vehicles to touch each other as this could establish a ground connection and personal injury could result.
- Failure to follow this procedure could result in personal injury or property damage due to battery explosion.
- Do not connect the cable to the negative post (-) of the discharged battery. The resulting electrical spark could cause the battery to explode and could result in personal injury.

## SHIFT LEVER OVERRIDE



- If a malfunction occurs and the shift lever cannot be moved out of the PARK position, you can use the following procedure to temporarily move the shift lever:
  - To access the shift lever override, remove the override cover located on the PRNDL bezel, next to the shift lever.
  - Firmly set the parking brake.
  - Turn the ignition switch to the ACC or ON position without starting the engine.

- Press and maintain firm pressure on the brake pedal.
- Using a screwdriver or similar tool, press and hold the override tab through the access port on the center console.
- Move the shift lever into the NEUTRAL position.
- The vehicle may then be started in NEUTRAL.
- Reinstall the override cover.

# WHAT TO DO IN EMERGENCIES

## TOWING A DISABLED VEHICLE

Model	Flat Towing (all four wheels on the ground)	Flatbed Towing (all four wheels suspended OFF the ground)	Front Wheels Raised, Rear Wheels on the Ground	Rear Wheels Raised, Front Wheels on the Ground
<b>Two-Wheel Drive</b>	NOT Permitted	Recommended Method	Shift lever must be in NEUTRAL, the speed less than 30 mph (48 km/h) and the distance traveled less than 15 mi (24 km).	Shift lever must be in NEUTRAL, the speed less than 30 mph (48 km/h) and the distance traveled less than 15 mi (24 km).
<b>Four-Wheel Drive</b>	NOT Permitted	Recommended Method	NOT Permitted	NOT Permitted

# WHAT TO DO IN EMERGENCIES

## FREEING A STUCK VEHICLE

- If your vehicle becomes stuck in mud, sand or snow, it can often be moved by a rocking motion. Turn your steering wheel right and left to clear the area around the front wheels. Then shift back and forth between DRIVE and REVERSE. Using minimal accelerator pedal pressure to maintain the rocking motion, without spinning the wheels, is most effective.

**NOTE:** If your vehicle is equipped with Traction Control or Electronic Stability Control (ESC), turn the system OFF before attempting to “rock” the vehicle.

### CAUTION!

- Racing the engine or spinning the wheels may lead to transmission overheating and failure. Allow the engine to idle with the shift lever in NEUTRAL for at least one minute after every five rocking-motion cycles. This will minimize overheating and reduce the risk of transmission failure during prolonged efforts to free a stuck vehicle.
- When “rocking” a stuck vehicle by moving between DRIVE and REVERSE, do not spin the wheels faster than 15 mph (24 km/h), or drivetrain damage may result.
- Revving the engine or spinning the wheels too fast may lead to transmission overheating and failure. It can also damage the tires. Do not spin the wheels above 30 mph (48 km/h) while in gear (no transmission shifting occurring).

### WARNING!

Fast spinning tires can be dangerous. Forces generated by excessive wheel speeds may cause damage, or even failure, of the axle and tires. A tire could explode and injure someone. Do not spin your vehicle's wheels faster than 30 mph (48 km/h) or for longer than 30 seconds continuously without stopping when you are stuck and do not let anyone near a spinning wheel, no matter what the speed.

# WHAT TO DO IN EMERGENCIES

## EVENT DATA RECORDER (EDR)

- This vehicle is equipped with an event data recorder (EDR). The main purpose of an EDR is to record, in certain crash or near crash-like situations, such as an air bag deployment or hitting a road obstacle, data that will assist in understanding how a vehicle's systems performed. The EDR is designed to record data related to vehicle dynamics and safety systems for a short period of time, typically 30 seconds or less. The EDR in this vehicle is designed to record such data as:
  - How various systems in your vehicle were operating;
  - Whether or not the driver and passenger safety belts were buckled/fastened;
  - How far (if at all) the driver was depressing the accelerator and/or brake pedal; and,
  - How fast the vehicle was traveling.
- These data can help provide a better understanding of the circumstances in which crashes and injuries occur.

**NOTE:** EDR data are recorded by your vehicle only if a non-trivial crash situation occurs; no data are recorded by the EDR under normal driving conditions and no personal data (e.g. name, gender, age, and crash location) are recorded. However, other parties, such as law enforcement, could combine the EDR data with the type of personally identifying data routinely acquired during a crash investigation.

- To read data recorded by an EDR, special equipment is required, and access to the vehicle or the EDR is needed. In addition to the vehicle manufacturer, other parties such as law enforcement, that have the special equipment, can read the information if they have access to the vehicle or the EDR.

# MAINTAINING YOUR VEHICLE

## OPENING THE HOOD



- Pull the release lever located below the instrument panel and in front of the driver's door.
- Raise the hood and locate the safety latch, in the middle of the hood opening.
- Move the safety latch while lifting the hood at the same time.
- Insert the support rod into the slot on the hood.
- To close the hood, remove the support rod and place it in the retaining clip, then lower the hood slowly.

### WARNING!

Be sure the hood is fully latched before driving your vehicle. If the hood is not fully latched, it could open when the vehicle is in motion and block your vision. Failure to follow this warning could result in serious injury or death.



# MAINTAINING YOUR VEHICLE

## ENGINE COMPARTMENT

### 3.7L Engine

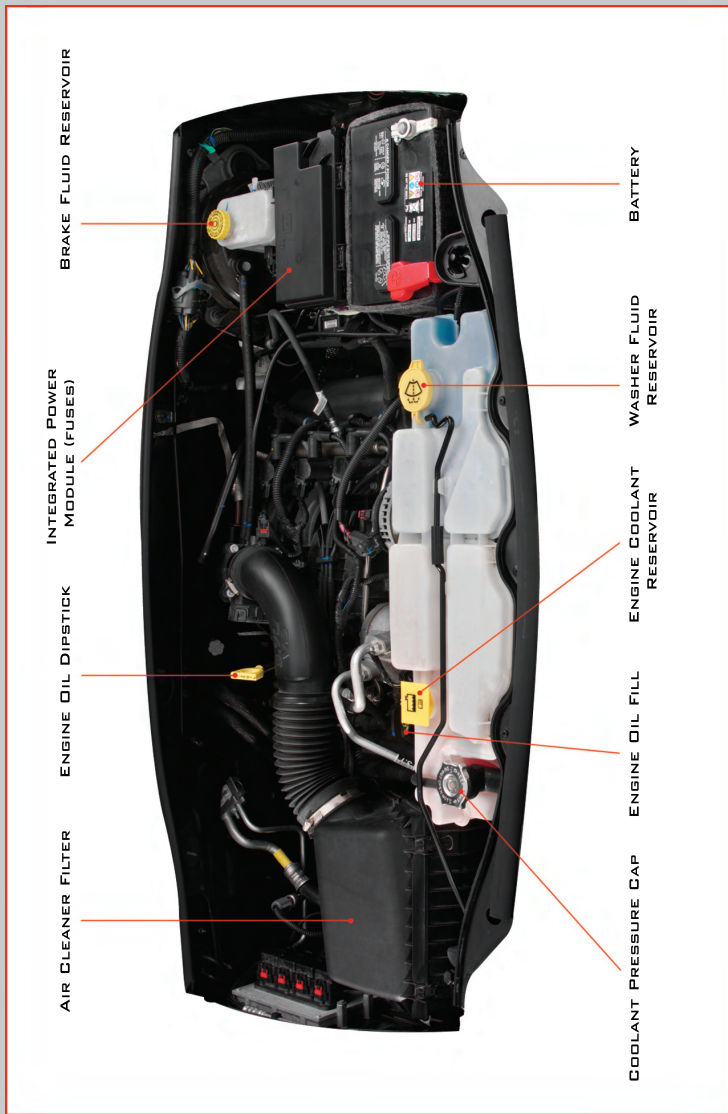

# MAINTAINING YOUR VEHICLE

## 4.0L Engine

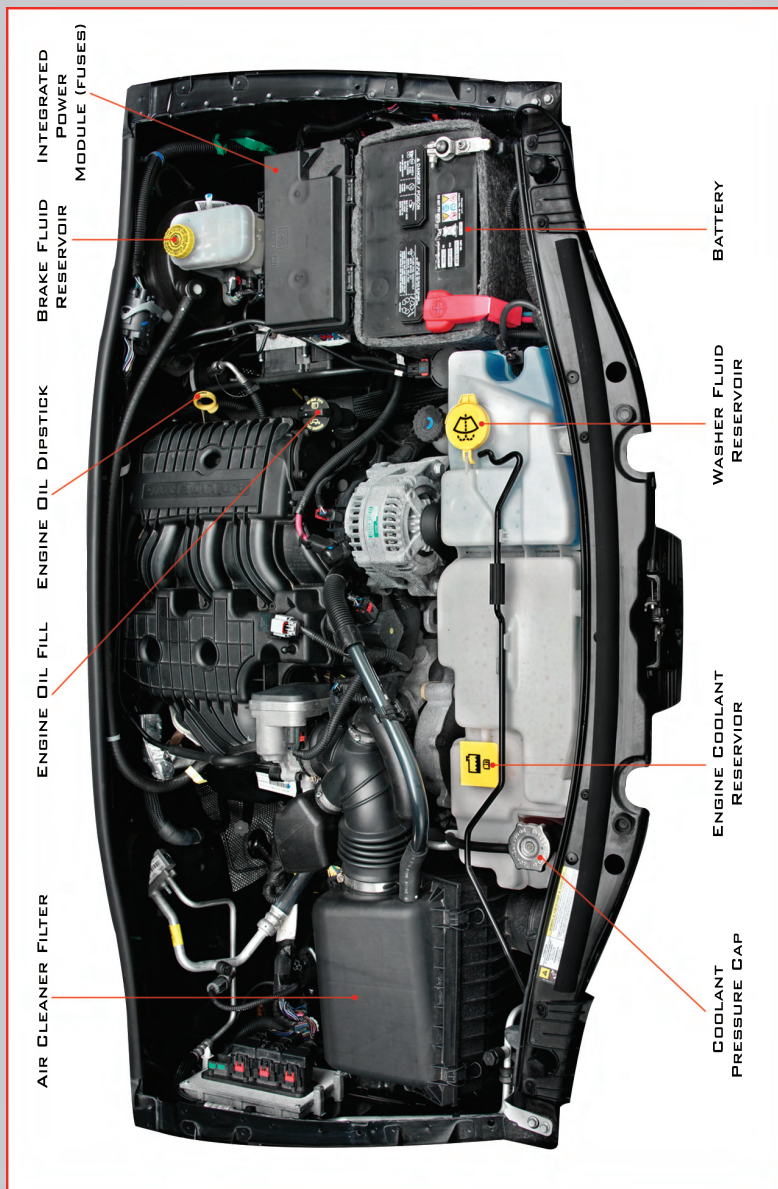

# MAINTAINING YOUR VEHICLE

## FLUIDS AND CAPACITIES

Component	Fluid, Lubricant, or Genuine Part	Capacities
Engine Coolant 3.7L, 4.0L	MOPAR® Antifreeze/Coolant Five Year/100,000 Mile Formula HOAT (Hybrid Organic Additive Technology) or equivalent.	14 Quarts (13.3 Liters) Includes heater and coolant recovery bottle filled to MAX level.
Engine Oil with Filter 3.7L	API certified 5W-20 engine oil, meeting the requirements of Chrysler Material Standard MS-6395. Refer to your oil filler cap for correct SAE grade.	5 Quarts (4.7L Liters)
Engine Oil with Filter 4.0L	API certified 10W-30 engine oil, meeting the requirements of Chrysler Material Standard MS-6395. Refer to your oil filler cap for correct SAE grade.	5.5 Quarts (5.2 Liters)
Fuel Selection 3.7L, 4.0L	87 Octane acceptable. 89 octane Recommended for 4.0L.	19.5 Gallons (73.8 Liters)
Engine Oil Filter 3.7L, 4.0L	MOPAR® Engine Oil Filter or equivalent.	—
Spark Plug 3.7L	ZFR6F-11G (Gap 0.043 in [1.09 mm])	—
Spark Plug 4.0L	ZFR5LP-13G (Gap 0.050 in [1.27 mm])	—
Automatic Transmission	MOPAR® ATF+4® Automatic Transmission Fluid or equivalent licensed ATF+4® product.	—
Transfer Case	MOPAR® ATF+4® Automatic Transmission Fluid or equivalent licensed ATF+4® product.	—
Front Axle	SAE80W-90 Multi-Purpose Type GL-5 Gear Lube or equivalent.	—
Rear Axle	MOPAR® Synthetic Gear & Axle Lubricant SAE 75W-90 or equivalent.	—

# MAINTAINING YOUR VEHICLE

Component	Fluid, Lubricant, or Genuine Part	Capacities
Brake Master Cylinder	MOPAR® DOT 3 and SAE J1703 should be used or equivalent. If DOT 3 is not available, then DOT 4 is acceptable. Use Only recommended Brake Fluids.	—
Power Steering Reservoir	MOPAR® ATF+4® Automatic Transmission Fluid or equivalent licensed ATF+4® product.	—

# MAINTAINING YOUR VEHICLE

## MAINTENANCE CHART

	Miles:		24,000		32,000		40,000		48,000		56,000		64,000		72,000		80,000		88,000		96,000		104,000	
	8,000	16,000	12	18	24	30	36	42	48	54	60	66	72	78	84	90	96	102	108	114	120	126	132	138
Or Months:	6	12	18	24	30	36	42	48	54	60	66	72	78	84	90	96	102	108	114	120	126	132	138	144
Or Kilometers:	13,000	26,000	39,000	52,000	65,000	78,000	91,000	104,000	117,000	130,000	143,000	156,000	169,000	182,000	195,000	208,000	221,000	234,000	247,000	260,000	273,000	286,000	299,000	312,000
Change the engine oil and engine oil filter.	X	X	X	X	X	X	X	X	X	X	X	X	X	X	X	X	X	X	X	X	X	X	X	X
Rotate the tires, rotate at the first sign of irregular wear, even if it occurs before scheduled maintenance.	X	X	X	X	X	X	X	X	X	X	X	X	X	X	X	X	X	X	X	X	X	X	X	X
If using your vehicle for any of the following: dusty or off-road conditions. Inspect the engine air cleaner filter; replace if necessary.		X				X				X					X									
Inspect the brake linings; replace if necessary.		X				X				X					X									
Inspect the CV joints.			X								X					X								
Inspect the exhaust system.		X	X												X									
Replace the engine air cleaner filter.										X						X								
Inspect the front and rear axle fluid, change if using your vehicle for police, taxi, fleet, off-road or frequent trailer towing.			X			X					X				X							X		
Inspect the transfer case fluid.							X															X		
Change the transfer case fluid if using your vehicle for the following: police, taxi, fleet or frequent trailer towing.														X										
Adjust the parking brake on vehicles equipped with four wheel disc brakes.							X															X		
Change the automatic transmission fluid and filter if using your vehicle for any of the following: police, taxi, fleet or frequent trailer towing.														X										
Inspect front suspension, tie rod ends, and boot seals for cracks or leaks and all parts for damage, wear, improper looseness or end play; replace if necessary.		X				X					X											X		
Flush and replace engine coolant.																						X		X

# MAINTAINING YOUR VEHICLE

	Miles: 8,000	16,000	24,000	32,000	40,000	48,000	56,000	64,000	72,000	80,000	88,000	96,000	104,000
Or Months: 6	12	18	24	30	36	42	48	54	60	66	72	78	
Or Kilometers: 13,000	26,000	39,000	52,000	65,000	78,000	91,000	104,000	117,000	130,000	143,000	156,000	169,000	
Replace the timing belt (4.0L engine).													X
Replace the spark plugs (4.0L engine).													X
Replace the spark plugs (3.7L engine).			X				X					X	
Replace the ignition cables (3.7L engine).							X						
Inspect and replace PCV valve if necessary.												X	

- Refer to the Owner's Manual on the DVD for the complete maintenance schedule.

# MAINTAINING YOUR VEHICLE

## Maintenance Record

	Odometer	Date	Signature, Authorized Service Center
8,000 Miles (13,000 km) or 6 Months			
16,000 Miles (26,000 km) or 12 Months			
24,000 Miles (39,000 km) or 18 Months			
32,000 Miles (52,000 km) or 24 Months			
40,000 Miles (65,000 km) or 30 Months			
48,000 Miles (78,000 km) or 36 Months			
56,000 Miles (91,000 km) or 42 Months			
64,000 Miles (104,000 km) or 48 Months			
72,000 Miles (117,000 km) or 54 Months			
80,000 Miles (130,000 km) or 60 Months			
88,000 Miles (143,000 km) or 66 Months			
96,000 Miles (156,000 km) or 72 Months			
104,000 Miles (169,000 km) or 78 Months			

# MAINTAINING YOUR VEHICLE

## FUSES

### Integrated Power Module (fuses)

- The Integrated Power Module is located in the engine compartment near the battery. This center contains cartridge fuses, mini-fuses and relays.

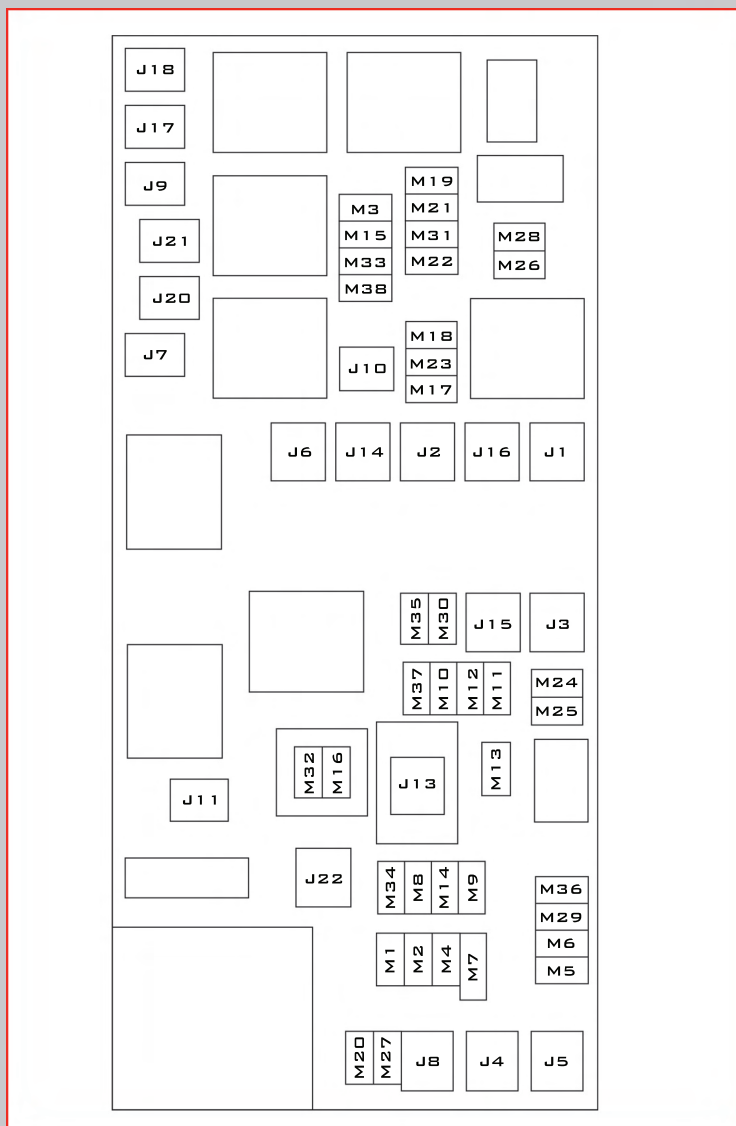



# MAINTAINING YOUR VEHICLE

Cavity	Cartridge Fuse	Mini-Fuse	Description
J1	–		–
J2	30 Amp Pink		Transfer Case/Pwr Liftgate Module
J3	–		–
J4	25 Amp Natural		Driver Door Node
J5	25 Amp Natural		Passenger Door Node
J6	40 Amp Green		Anti-Lock Brake System (ABS) Pump/ESP
J7	30 Amp Pink		Anti-Lock Brake System (ABS) Valve/ESP
J8	40 Amp Green		Power Memory Seat (If Equipped)
J9	–		–
J10	–		–
J11	30 Amp Pink		Anti-Theft Module Lock-Unlock
J13	60 Amp Yellow		Ignition Off Draw (IOD) — Main
J14	40 Amp Green		EBL (Rear Window Defogger)
J15	40 Amp Green		Front Blower
J17	40 Amp Green		Starter Solenoid
J18	20 Amp Blue		Powertrain Control Module (PCM) Trans Range
J19	60 Amp Yellow		Radiator Fan
J20	30 Amp Pink		Front Wiper LO/HI
J21	20 Amp Blue		Front/Rear Washer
J22	25 Amp Natural		Sunroof Module
M1		15 Amp Blue	Center High Mounted Stop Light (CHMSL)/Brake Switch
M2		20 Amp Yellow	Trailer Lighting
M3		20 Amp Yellow	Frnt/Rear Axle Lockers
M4		10 Amp Red	Trailer Tow
M5		25 Amp Natural	Inverter
M6		20 Amp Yellow	Power Outlet #1/Rain Sensor
M7		20 Amp Yellow	Power Outlet #2 (BATT/ACC SELECT)
M8		20 Amp Yellow	Front Heated Seat
M9		–	–
M10		15 Amp Blue	Ignition Off Draw — Vehicle Entertainment System (IOD-VES), Satellite Digital Audio Receiver (SDARS), DVD, Hands-Free Module (HFM), RADIO, Antenna (ANT), Universal Garage Door Opener (UGDO), Vanity Lamp (VANITY LP)

# MAINTAINING YOUR VEHICLE

Cavity	Cartridge Fuse	Mini-Fuse	Description
M11		10 Amp Red	(Ignition Off Draw) IOD-HVAC/ATC, MW SENSr, Underhood Lamp (UH LMP)
M12		30 Amp Green	Amplifier (AMP)
M13		20 Amp Yellow	Ignition Off Draw— Cabin Compartment Node (IOD-CCN), Wireless Control Module (WCM), SIREN, Clock Module (CLK MOD), Multifunction Control Switch (MULTIFCTN SW)
M14		20 Amp Yellow	Trailer Tow (Export Only)
M15		20 Amp Yellow	COL MOD, IR SNS, Heater Ventilation, Air Conditioning/ Automatic Temperature Control (HVAC/ATC), Rearview Mirror (RR VW MIR), Cabin Compartment Node (CCN), Transfer Case Switch (T-CASE SW), RUN/ST, Multifunction Control Switch (MULTIFCTN SW), Tire Pressure Monitor (TPM), Glow Plug Module (GLW PLG MOD) — Export Diesel Only
M16		10 Amp Red	Occupant Restraint Controller/ Occupant Classification Module (ORC/OCM)
M17		15 Amp Blue	Left Tail/License/Park Lamp (LT-TAIL/LIC/PRK LMP)
M18		15 Amp Blue	Right Tail/Park/Run Lamp (RT-TAIL/PRK/RUN LMP)
M19		25 Amp Natural	Auto Shut Down (ASD #1 and #2)
M20		15 Amp Blue	Cabin Compartment Node Interior Light (CCN INT LIGHT), Switch Bank (SW BANK), Steering Control Module (SCM)
M21		20 Amp Yellow	Auto Shut Down (ASD #3)
M22		10 Amp Red	Right Horn (RT HORN (HI/LOW))
M23		10 Amp Red	Left Horn (LT HORN (HI/LOW))
M24		25 Amp Natural	Rear Wiper (REAR WIPER)
M25		20 Amp Yellow	Fuel Pump (FUEL PUMP), Diesel Lift Pump (DSL LIFT PUMP) — Export Only
M26		10 Amp Red	Power Mirror Switch (PWR MIRR SW), Driver Window Switch (DRVR WIND SW)

# MAINTAINING YOUR VEHICLE

Cavity	Cartridge Fuse	Mini-Fuse	Description
M27		10 Amp Red	Ignition Switch (IGN SW), Window Module (WIN MOD)
M28		10 Amp Red	Next Generation Controller (NGC), Transmission Feed (TRANS FEED), J1962
M29		10 Amp Red	Occupant Classification Module (OCM)
M30		15 Amp Blue	Rear Wiper Module (RR WIPER MOD), Power Folding Mirror (PWR FOLD MIR)
M31		20 Amp Yellow	Back-Up Lamps (B/U LAMPS)
M32		10 Amp Red	Occupant Restraint Controller (ORC), TT EUROPE
M33		10 Amp Red	Next Generation Controller (NGC), Global Powertrain Engine Controller (GPEC)
M34		10 Amp Red	Park Assist (PRK ASST), Heater Ventilation, Air Conditioning Module (HVAC MOD), Headlamp Wash (HDLP WASH), Compass (COMPAS)
M35		10 Amp Red	Heated Mirrors
M36		–	–
M37		10 Amp Red	Anti-Lock Brake System (ABS), Electronic Stability Program (ESP), Stop Lamp Switch (STP LP SW), Fuel Pump Rly Hi Control
M38		25 Amp Natural	Lock/Unlock Motors (LOCK/ UNLOCK MTRS)

## CAUTION!

- When installing the integrated power module cover, it is important to ensure the cover is properly positioned and fully latched. Failure to do so may allow water to get into the integrated power module and possibly result in a electrical system failure.
- When replacing a blown fuse, it is important to use only a fuse having the correct amperage rating. The use of a fuse with a rating other than indicated may result in a dangerous electrical system overload. If a properly rated fuse continues to blow, it indicates a problem in the circuit that must be corrected.

# MAINTAINING YOUR VEHICLE

## TIRE PRESSURES

- Check the inflation pressure of each tire, including the spare tire, at least monthly and inflate to the recommended pressure for your vehicle.
- The tire pressures recommended for your vehicle are found on the “Tire and Loading Information” label located on the driver’s side door opening.

**NOTE:** Refer to the Owner’s Manual on the DVD for more information regarding tire warnings and instructions.

### WARNING!

- Overloading of your tires is dangerous. Overloading can cause tire failure, affect vehicle handling, and increase your stopping distance. Use tires of the recommended load capacity for your vehicle. Never overload them.
- Improperly inflated tires are dangerous and can cause collisions. Under-inflation is the leading cause of tire failure and may result in severe cracking, component separation, or “blow out”. Over-inflation reduces a tire’s ability to cushion shock. Objects on the road and chuck holes can cause damage that results in tire failure. Unequal tire pressures can cause steering problems. You could lose control of your vehicle. Over-inflated or under-inflated tires can affect vehicle handling and can fail suddenly, resulting in loss of vehicle control.

## WHEEL AND WHEEL TRIM CARE

- All wheels and wheel trim, especially aluminum and chrome plated wheels, should be cleaned regularly with a mild soap and water to prevent corrosion.
- To remove heavy soil and/or excessive brake dust, use MOPAR® Wheel Cleaner or equivalent or select a non-abrasive, non-acidic cleaner.

### CAUTION!

Do not use scouring pads, steel wool, a bristle brush, or metal polishes. Do not use oven cleaner. These products may damage the wheel’s protective finish. Avoid automatic car washes that use acidic solutions or harsh brushes that may damage the wheel’s protective finish. Only MOPAR® Wheel Cleaner or equivalent is recommended.

# MAINTAINING YOUR VEHICLE

## EXTERIOR BULBS

<b>LIGHT BULBS – Exterior</b>	<b>Bulb Number</b>
Backup, Tail, Stop, Turn Lamp	3057K
Center High-Mounted Stop Lamp (CHMSL)	LED (*)
Fog Lamp – If Equipped	PSX24W
Front Park/Turn Signal	3157AK
Front Side Marker	168
Headlamp – Low Beam	9008 H13
License Lamp	168

\* CHMSL is not serviceable. It is a LED lamp. To replace the LED, the entire CHMSL assembly must be replaced.

# CONSUMER ASSISTANCE

## CHRYSLER GROUP LLC CUSTOMER CENTER

P.O. Box 21-8004

Auburn Hills, MI 48321-8004

Phone: 1-800-423-6343

## CHRYSLER CANADA INC. CUSTOMER CENTER

P.O. Box 1621

Windsor, Ontario N9A 4H6

Phone: 1-800-465-2001 (English)

Phone: 1-800-387-9983 (French)

## ASSISTANCE FOR THE HEARING IMPAIRED

- To assist customers who have hearing difficulties, the manufacturer has installed special TDD (Telecommunication Devices for the Deaf) equipment at its customer center. Any hearing or speech impaired customer, who has access to a TDD or a conventional teletypewriter (TTY) in the United States, can communicate with the manufacturer by dialing 1-800-380-CHRY. Canadian residents with hearing difficulties that require assistance can use the special needs relay service offered by Bell Canada. For TTY teletypewriter users, dial 711 and for Voice callers, dial 1-800-855-0511 to connect with a Bell Relay Service operator.

### WARNING!

Engine exhaust, some of its constituents, and certain vehicle components contain, or emit, chemicals known to the State of California to cause cancer and birth defects, or other reproductive harm. In addition, certain fluids contained in vehicles and certain products of component wear contain, or emit, chemicals known to the State of California to cause cancer and birth defects, or other reproductive harm.

## PUBLICATIONS ORDERING

- **If you are the first registered retail owner of your vehicle**, you may obtain one free printed copy of the Owner's Manual, Warranty Booklet or Radio Manuals on your DVD by calling 1-800-423-6343 (U.S.) or 1-800-387-1143 (Canada) or by contacting your dealer.
- Replacement User Guide kits or DVDs or, if you prefer, additional printed copies of the Owner's Manual, Warranty Booklet or Radio Manuals may be purchased by visiting [www.techauthority.com](http://www.techauthority.com) or by calling 1-800-890-4038 (U.S.) or 1-800-387-1143 (Canada). Visa, Master Card, American Express and Discover orders are accepted. If you prefer mailing your order, please call the above numbers for an order form.

**NOTE:** A street address is required when ordering manuals (no P.O. Boxes).

# CONSUMER ASSISTANCE

## NOTE:

- The Owner's Manual and User Guide electronic files are also available on the Chrysler, Jeep and Dodge websites.
- Click on the "For Owners" tab, select "Owner/Service Manuals", then select your desired model year and vehicle from the drop down lists.

## REPORTING SAFETY DEFECTS IN THE 50 UNITED STATES AND WASHINGTON, D.C.

- If you believe that your vehicle has a defect that could cause a collision or cause injury or death, you should immediately inform the National Highway Traffic Safety Administration (NHTSA) in addition to notifying the manufacturer.
- If NHTSA receives similar complaints, it may open an investigation, and if it finds that a safety defect exists in a group of vehicles, it may order a recall and remedy campaign. However, NHTSA cannot become involved in individual problems between you, your authorized dealer, and the manufacturer.

- To contact NHTSA, you may either call the Auto Safety Hotline toll free at 1-888-327-4236 (TTY: 1-800-424-9153), or go to <http://www.safercar.gov>; or write to: Administrator, NHTSA, 1200 New Jersey Avenue, SE., West Building, Washington, D.C. 20590. You can also obtain other information about motor vehicle safety from <http://www.safercar.gov>.

## In Canada

- If you believe that your vehicle has a safety defect, you should contact the Customer Service Department immediately. Canadian customers who wish to report a safety defect to the Canadian government should contact Transport Canada, Motor Vehicle Defect Investigations and Recalls at 1-800-333-0510 or go to <http://www.tc.gc.ca/roadsafety/>
- French Canadian customers who wish to report a safety defect to the Canadian government should contact Transport Canada, Motor Vehicle Defect Investigations and Recalls at 1-800-333-0510 or go to <http://www.tc.gc.ca/securiteroutiere/>

# MOPAR ACCESSORIES

## AUTHENTIC ACCESSORIES BY MOPAR®

- The following highlights just some of the many Authentic Dodge Accessories by Mopar featuring a fit, finish, and functionality specifically for your Dodge Nitro.
- In choosing Authentic Accessories you gain far more than expressive style, premium protection, or extreme entertainment, you also benefit from enhancing your vehicle with accessories that have been thoroughly tested and factory-approved.
- For the full line of Authentic Dodge Accessories by Mopar, visit your local Dodge dealership or online at [mopar.com](http://mopar.com).

### CHROME:

- Mirror Covers
- Front Air Deflector
- Rock Rails
- Tubular Side Steps
- Fuel Door
- Wheels
- Body Side Moldings
- Front Fascia Accent

### EXTERIOR:

- Black Tubular Side Steps
- Tail Lamp Guards
- Wheels
- Front End Cover
- Hitch Receiver
- Smoke Front Air Deflector
- Molded Splash Guards
- Rear Air Deflector

### INTERIOR:

- Premium Carpet Floor Mats
- Security Cover
- Slush Mats
- Billet Aluminum Shift Knob
- Bright Pedal Kit
- Door Sill Guards
- Premium Carpet Cargo Mat
- Ambient Light Kit

### ELECTRONICS:

- Portable Navigation Systems
- Media Center 730N (Sales Code RER)
- iPod® Adapter
- Uconnect™ Web (WiFi)
- Remote Start
- Rear View Camera
- Rear Seat Video
- Heated Seats

### CARRIERS:

- Hitch-mount Bike Carrier
- Roof Top Cargo Basket
- Sport Utility Bars
- Roof-mount Ski and Snowboard Carrier
- Roof-mount Bike Carrier
- Roof Box Cargo Carrier

iPod® is a registered trademark of Apple, Inc.



# INDEX

- Air Conditioning . . . . . 20
- Airbag . . . . . 10
- Airbag Light . . . . . 51
- Alarm, Panic . . . . . 8
- Anti-Lock Brake System (ABS) . . . 50
- Arming Theft System (Security Alarm) . . . . . 9
- Automatic Temperature Control (ATC) . . . . . 20
- Automatic Transmission
  - Fluid Type . . . . . 65
- Axle Fluid . . . . . 65
- Battery
  - Charging System Light . . . . . 50
- Belts, Seat . . . . . 9
- Brake Assist System . . . . . 50
- Brake Fluid . . . . . 65
- Brake System
  - Warning Light . . . . . 49
- Bulb Replacement . . . . . 75
- Calibration, Compass . . . . . 39
- Cargo Area Features . . . . . 45
- Cargo Load Floor . . . . . 45
- Cargo Tie-Downs . . . . . 45
- Change Oil Indicator . . . . . 51
- Charging System Light . . . . . 50
- Check Engine Light (Malfunction Indicator Light) . . . . . 50
- Child Restraint . . . . . 11
- Child Restraint Tether Anchors . . . 11
- Climate Control . . . . . 20
- Clock Setting . . . . . 28,30
- Compass Calibration . . . . . 39
- Cooling System
  - Coolant Capacity . . . . . 65
- Cruise Control (Speed Control) . . . 19
- Cruise Light . . . . . 19
- Customer Assistance . . . . . 76
- Defects, Reporting . . . . . 77
- Defroster, Rear Window . . . . . 20
- Defroster, Windshield . . . . . 20
- Dimmer Control . . . . . 17
- Dimmer Switch, Headlight . . . . . 17
- Disarming, Theft System . . . . . 9
- Driver Cockpit . . . . . 4
- ECO . . . . . 39
- Electronic Speed Control (Cruise Control) . . . . . 19
- Electronic Stability Program (ESP) . . . . . 48,50
- Electronic Throttle Control Warning Light . . . . . 51
- Electronic Vehicle Information Center (EVIC) . . . . . 38,39
- Engine
  - Compartment . . . . . 63
  - Malfunction Indicator (Check Engine) . . . . . 50
  - Oil Selection . . . . . 65
  - Overheating . . . . . 52
- Event Data Recorder . . . . . 61
- Express Down Windows . . . . . 8
- Exterior Lights . . . . . 75
- Flash-To-Pass . . . . . 17
- Fluid Capacities . . . . . 65
- Fluids . . . . . 65
- Fog Lights . . . . . 17
- Folding Front Passenger Seat . . . 13
- Folding Rear Seat . . . . . 14
- Four Wheel Drive Operation . . . . 44
- Freeing A Stuck Vehicle . . . . . 60
- Front Heated Seats . . . . . 15
- Fuel
  - Filler Cap (Gas Cap) . . . . . 51
  - Specifications . . . . . 65
- Fuses . . . . . 70
- Garage Door Opener (HomeLink®) . 41
- Gas Cap (Fuel Filler Cap) . . . . . 51
- Hard Disk Drive . . . . . 31
- Headlights
  - Dimmer Switch . . . . . 17
  - High Beam . . . . . 17
- Heated Seats . . . . . 15
- High Beam/Low Beam Select (Dimmer) Switch . . . . . 17
- HomeLink® (Garage Door Opener) Transmitter . . . . . 41

# INDEX

- Hood Release . . . . . 62
- Instrument Cluster . . . . . 6
- Instrument Cluster Warning
- Lights . . . . . 6,48
- Integrated Power Module (Fuses) . . . . . 70
- Intermittent Wipers (Delay Wipers) . . . . . 18
- Introduction . . . . . 2
  
- Jack Location . . . . . 53
- Jump Starting . . . . . 56
  
- Key Fob . . . . . 8
- Key Fob Programmable Features . . 39
  
- Lane Change Assist . . . . . 18
- LATCH (Lower Anchors and Tether for CHildren) . . . . . 11
- Lights
  - Four-Wheel Drive Indicator . . . . 51
  - Headlights . . . . . 17
  - Park . . . . . 17
  - Transmission Warning . . . . . 51
  - Turn Signal . . . . . 18
  - Warning (Instrument Cluster Description) . . . . . 6
  
- Maintenance Record . . . . . 69
- Maintenance Schedule . . . . . 67
- Malfunction Indicator Light (Check Engine) . . . . . 50
- MOPAR® Accessories . . . . . 78
  
- Navigation . . . . . 32,33
  
- Oil Change Indicator . . . . . 51
- Oil Change Indicator, Reset . . . . 51
- Oil Pressure Light . . . . . 50
- Oil, Engine
  - Capacity . . . . . 65
- Overheating, Engine . . . . . 52
  
- Panic Alarm . . . . . 8
- Park Sense System, Rear . . . . . 21
  
- Phone (Pairing) . . . . . 36
- Phone (Uconnect) . . . . . 35
- Power
  - Glass Sunroof . . . . . 21
  - Outlet (Auxiliary Electrical Outlet) . . . . . 43
  - Seats . . . . . 13
  - Steering . . . . . 65
- Preparation for Jacking . . . . . 53
- Programmable Electronic Features . . . . . 39
  
- Radio Operation . . . . . 26,29
- Rain Sensitive Wiper System . . . . 18
- Rear Park Sense System . . . . . 21
- Rear Seat, Folding . . . . . 14
- Recreational Towing . . . . . 47
- Remote Starting System . . . . . 8
- Replacement Bulbs . . . . . 75
- Restraints, Child . . . . . 11
- Roll Over Warning . . . . . 3
  
- Seat Belts . . . . . 9
- Seats . . . . . 13
  - Adjustment . . . . . 13
  - Folding Front Passenger . . . . . 13
  - Heated . . . . . 15
  - Power . . . . . 13
  - Rear Folding . . . . . 14
- Setting the Clock . . . . . 28,30
- Shift Lever Override . . . . . 58
- Signals, Turn . . . . . 18
- Spare Tire . . . . . 53
- Spark Plugs . . . . . 65
- Speed Control (Cruise Control) . . 19
- Starting
  - Remote . . . . . 8
- Steering
  - Tilt Column . . . . . 16
- Steering Wheel Audio Controls . . . 35
- Store Radio Presets . . . . . 28,30
- Stuck, Freeing . . . . . 60
- Sun Roof . . . . . 21
- Supplemental Restraint System - Airbag . . . . . 10
  
- Temperature Control, Automatic (ATC) . . . . . 20

# INDEX

Theft Alarm (Security Alarm) . . . . .	9	Transfer Case	
Theft System Arming . . . . .	9	Fluid . . . . .	65
Theft System Disarming . . . . .	9	Transmission	
Tilt Steering Column . . . . .	16	Fluid . . . . .	65
Tires		Turn Signals . . . . .	18
Air Pressure . . . . .	74		
Changing . . . . .	54	Uconnect™ Phone . . . . .	35
Flat Changing . . . . .	54		
Jacking . . . . .	54	Voice Command . . . . .	37
Pressure Warning Light . . . . .	48		
Towing . . . . .	46	Warning Lights . . . . .	48
24-Hour Towing Assistance . . . . .	48	Washer, Rear . . . . .	18
Disabled Vehicle . . . . .	59	Washers, Windshield . . . . .	18
Recreational . . . . .	47	Wheel and Wheel Trim Care . . . . .	74
Towing Vehicle Behind a		Wind Buffeting . . . . .	23
Motorhome . . . . .	47	Windows, Express Down . . . . .	8
Trailer Towing		Windshield Washers . . . . .	18
Trailer and Tongue Weight . . . . .	46	Windshield Wipers . . . . .	18
Trailer Weight . . . . .	46	Wiper, Rear . . . . .	18



# NOTES



**Driving and Alcohol:** Drunken driving is one of the most frequent causes of collisions. Your driving ability can be seriously impaired with blood alcohol levels far below the legal minimum. If you are drinking, don't drive. Ride with a designated non-drinking driver, call a cab, a friend, or use public transportation.

**WARNING!**

Driving after drinking can lead to a collision. Your perceptions are less sharp, your reflexes are slower, and your judgment is impaired when you have been drinking. Never drink and then drive.



This guide has been prepared to help you get quickly acquainted with your new Dodge and to provide a convenient reference source for common questions. However, it is not a substitute for your Owner's Manual.

For complete operational instructions, maintenance procedures and important safety messages, please consult your Owner's Manual, Navigation/Media Center Manuals, Multimedia User Manual and other Warning Labels in your vehicle.

Not all features shown in this guide may apply to your vehicle. For additional information on accessories to help personalize your vehicle, visit [www.mopar.com](http://www.mopar.com) or your local Dodge dealer.

**DODGE**



11KA74-926-AA  
Nitro  
Fourth Edition  
User Guide