



**4C**

2016

Alpine® Radio

---

OWNER'S MANUAL SUPPLEMENT

# TABLE OF CONTENTS

SECTION		PAGE
1	SAFETY GUIDELINES .....	3
2	GETTING STARTED .....	19
3	HD RADIO .....	27
4	CD/MP3/WMA/AAC .....	37
5	SOUND SETTING .....	51
6	SETUP .....	87
7	BLUETOOTH HANDS FREE CALLING .....	109
8	ACCESSORIES .....	141
9	SIRIUSXM SATELLITE RADIO OPERATION (OPTIONAL) .....	167
10	ADDITIONAL INFORMATION .....	185



---

# SAFETY GUIDELINES

## CONTENTS

---

- WARNINGS/CAUTIONS/PRECAUTIONS . . . . .4
- CYBERSECURITY . . . . .16

## WARNINGS/CAUTIONS/PRECAUTIONS

### WARNING!

Always drive safely with your hands on the steering wheel and obey all applicable laws. You have full responsibility and assume all risks related to the use of the features and applications in this vehicle. Only use the features and applications in this vehicle when it is safe to do so. Failure to do so may result in an accident involving in serious injury or death.

### WARNING

This symbol means important instructions. Failure to heed them can result in serious injury or death.

**DO NOT OPERATE ANY FUNCTION THAT TAKES YOUR ATTENTION AWAY FROM SAFELY DRIVING YOUR VEHICLE.**

Any function that requires your prolonged attention should only be performed after coming to a complete stop. Always stop the vehicle in a safe location before performing these functions. Failure to do so may result in an accident.

**KEEP THE VOLUME AT A LEVEL WHERE YOU CAN STILL HEAR OUTSIDE NOISES WHILE DRIVING.**

Excessive volume levels that obscure sounds such as emergency vehicle sirens or road warning signals (train crossings, etc.) can be dangerous and may result in an accident. LISTENING AT LOUD VOLUME LEVELS IN A CAR MAY ALSO CAUSE HEARING DAMAGE.

**DO NOT DISASSEMBLE OR ALTER.**

Doing so may result in an accident, fire or electric shock.

**USE ONLY IN CARS WITH A 12 VOLT NEGATIVE GROUND.**

(Check with your dealer if you are not sure.) Failure to do so may result in fire, etc.

**KEEP SMALL OBJECTS SUCH AS BATTERIES OUT OF THE REACH OF CHILDREN.**

Swallowing them may result in serious injury. If swallowed, consult a physician immediately.

**USE THE CORRECT AMPERE RATING WHEN REPLACING FUSES.**

Failure to do so may result in fire or electric shock.

**DO NOT BLOCK VENTS OR RADIATOR PANELS.**

Doing so may cause heat to build up inside and may result in fire.

**USE THIS PRODUCT FOR MOBILE 12 VOLT APPLICATIONS.**

Use for other than its designed application may result in fire, electric shock or other injury.

**DO NOT PLACE HANDS, FINGERS OR FOREIGN OBJECTS IN INSERTION SLOTS OR GAPS.**

Doing so may result in personal injury or damage to the product.

** CAUTION**

**This symbol means important instructions. Failure to heed them can result in injury or material property damage.**

### **HALT USE IMMEDIATELY IF A PROBLEM APPEARS.**

Failure to do so may cause personal injury or damage to the product. Return it to your authorized Alpine dealer or the nearest Alpine Service Center for repairing.

### **⚠ PRECAUTIONS**

#### **Product Cleaning**

Use a soft dry cloth for periodic cleaning of the product. For more severe stains, please dampen the cloth with water only. Anything else has the chance of dissolving the paint or damaging the plastic.

#### **Temperature**

Ensure the temperature inside the vehicle is between +140° F (+60° C) and +14° F (-10° C) before turning your unit on.

#### **Moisture Condensation**

You may notice the CD playback sound wavering due to condensation. If this happens, remove the disc from the player and wait about an hour for the moisture to evaporate.

#### **Damaged Disc**

Do not attempt to play cracked, warped, or damaged discs. Playing a bad disc could severely damage the playback mechanism.

#### **Maintenance**

If you have problems, do not attempt to repair the unit yourself. Return it to your Alpine dealer or the nearest Alpine Service Station for servicing.

## Never Attempt the Following

Do not grip or pull out the disc while it is being pulled back into the player by the automatic reloading mechanism. Do not attempt to insert a disc into the unit when the unit power is off.

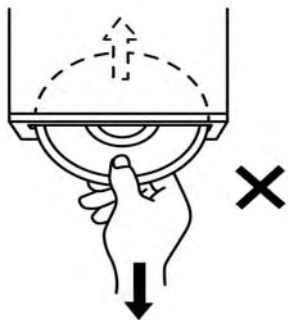

## Inserting Discs

Your player accepts only one disc at a time for playback. Do not attempt to load more than one disc.

Ensure the label side is facing up when you insert the disc. "Error" will be displayed on your player if you insert a disc incorrectly. If "Error" continues to be displayed even though the disc has been inserted correctly, push the RESET switch with a pointed object such as a ballpoint pen.

Playing a disc while driving on a very bumpy road may result in skips, but this will not scratch the disc or damage the player.

## New Discs

To prevent the CD from jamming, "Error" is displayed if discs with irregular surfaces are inserted or if discs are inserted incorrectly. When a new disc is ejected immediately after initial loading, use your finger to feel around



## 8 SAFETY GUIDELINES

the inside of the center hole and outside edge of the disc. If you feel any small bumps or irregularities, this could inhibit proper loading of the disc. To remove the bumps, rub the inside edge of the hole and outside edge of the disc with a ballpoint pen or other such instrument, then insert the disc again.

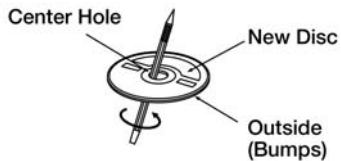
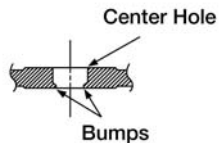

### Irregular Shaped Discs

Be sure to use round discs only for this unit and never use any special shaped discs.

Use of anything but round discs may cause damage to the mechanism.

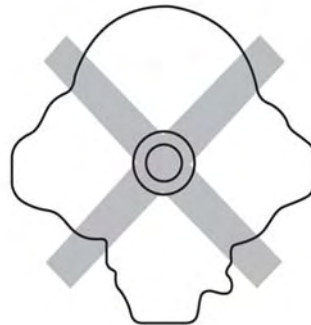

## Installation Location

Ensure this unit will not be installed in a location subjected to:

- Direct sun and heat
- High humidity and water
- Excessive dust
- Excessive vibrations

## Correct Handling

Do not drop the disc while handling. Hold the disc so you will not leave fingerprints on the surface. Do not affix tape, paper, or gummed labels to the disc. Do not write on the disc.

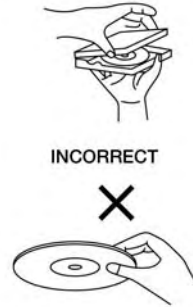

CORRECT



CORRECT



### Disc Cleaning

Fingerprints, dust, or soil on the surface of the disc could cause the CD player to skip. For routine cleaning, wipe the playing surface with a clean, soft cloth from the center of the disc to the outer edge. If the surface is heavily soiled, dampen a clean, soft cloth in a solution of mild neutral detergent before cleaning the disc.

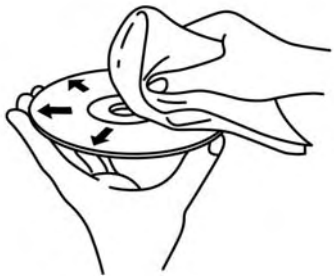

### Disc Accessories

There are various accessories available on the market for protecting the disc surface and improving sound quality. However, most of them will influence the thickness and/or diameter of the disc. Using such accessories can cause the disc to be out of standard specifications and may create operational problems. We recommend not using these accessories on discs played in Alpine CD players.

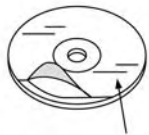

Transparent Sheet

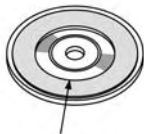

Disc Stabilizer

### On handling Compact Discs (CD/CD-R/CD-RW)

- Do not touch the surface.
- Do not expose the disc to direct sunlight.
- Do not affix stickers or labels.
- Clean the disc when it is dusty.

- Make sure that there are no bumps around the disc.
- Do not use commercially available disc accessories.

**Do not leave the disc in the car or the unit for a long time. Never expose the disc to direct sunlight.** Heat and humidity may damage the CD and you may not be able to play it again.

### To customers using CD-R/CD-RW

- If a CD-R/CD-RW cannot be played back, make sure the last recording session was closed (finalized).
- Finalize the CD-R/CD-RW if necessary, and attempt playback again.

### About media that can be played

Use only compact discs with the label side showing the CD logo marks below.



If you use unspecified compact discs, correct performance cannot be guaranteed.

You can play CD-Rs (CD-Recordables)/CD-RWs (CD-ReWritable) which have been recorded only on audio devices.

You can also play CD-Rs/CD-RWs containing MP3/WMA/AAC formatted audio files.

- Some of the following CDs may not play on this unit: Flawed CDs, CDs with fingerprints, CDs exposed to extreme temperatures or sunlight (e.g., left in the car or this unit), CDs recorded under unstable conditions, CDs on which a recording failed or a re-recording was attempted, copy-protected CDs which do not conform to the audio CD industry standard.
- Use discs with MP3/WMA/AAC files written in a format compatible with this unit. For details, refer to “About MP3/WMA/AAC” on page 44.
- ROM data other than audio files contained in a disc will not produce sound when played back.

## Protecting the USB connector

- Only a Flash Memory or iPod/iPhone can be connected to the USB port on this unit. Correct performance using other USB products cannot be guaranteed.
- If the USB connector is used, be sure to use a USB extension cable (supplied). A USB hub is not supported.
- Depending on the connected Flash Memory device, the unit may not function or some functions may not be performed.
- The audio file format that can be played back on the unit is MP3/WMA/AAC.
- Artist/song name, etc., can be displayed. Certain, special characters may not be correctly displayed.

## ⚠ On Handling Flash Memory

### CAUTION!

**Alpine accepts no responsibility for lost data, etc., even if data, etc. is lost while using this product.**

- To prevent malfunction or damage, note the following points. Read the Flash Memory Owner's Manual thoroughly. Do not touch the terminals by hand or metal. Do not subject Flash Memory to excessive shock. Do not bend, drop, disassemble, modify or soak in water.
- Avoid usage or storage in the following locations: Anywhere in the car exposed to direct sunlight or high temperatures. Anywhere the possibility of high humidity or corrosive substances are present.
- Fix the Flash Memory in a location where driver operation will not be hindered.

## 14 SAFETY GUIDELINES

- Flash Memory may not function correctly at high or low temperature.
  - Use only certified Flash Memory. Pay attention that even certified Flash Memory, may not function correctly depending on its type or state.
  - Flash Memory function is not guaranteed. Use Flash Memory according to the terms of agreement.
  - Depending on the settings of the Flash Memory type, memory state or encoding software, the unit may not play back or display properly.
  - A file that is copy-protected (copyright protection) cannot be played back.
  - Flash Memory may take time to start playback. If there is a particular file other than audio in the Flash Memory, it may take considerable time before the file is played back or searched.
  - The unit can play back “mp3”, “wma” or “m4a” file extensions.
  - Do not add the above extensions to a file other than audio data. This non-audio data will not be recognized. The resulting playback may contain noise that can damage speakers and/or amplifiers.
  - It is recommended to back up important data on a personal computer.
- Windows Media and the Windows logo are trademarks, or registered trademarks of Microsoft Corporation in the United States and/or other countries.
  - iPhone, iPod, iPod classic, iPod nano, and iPod touch are trademarks of Apple Inc., registered in the U.S. and other countries.

- “Made for iPod,” and “Made for iPhone,” mean that an electronic accessory has been designed to connect specifically to iPod, or iPhone, respectively, and has been certified by the developer to meet Apple performance standards. Apple is not responsible for the operation of this device or its compliance with safety and regulatory standards. Please note that the use of this accessory with iPod, or iPhone may affect wireless performance.
- The BLUETOOTH word mark and logos are registered trademarks owned by the Bluetooth SIG, Inc. and any use of such marks by Alpine Electronics, Inc. is under license. Other trademarks and trade names are those of their respective owners.

- MPEG Layer-3 audio coding technology licensed from Fraunhofer IIS and Thomson. Supply of this product only conveys a license for private, non-commercial use and does not convey a license nor imply any right to use this product in any commercial (i.e. revenue-generation) real time broadcasting (terrestrial, satellite, cable and/or any other media), broadcasting/streaming via internet, intranets and/or other networks or in other electronic content distribution systems, such as pay-audio or audio-on-demand applications. An independent license for such use is required. For details, please visit <http://www.mp3licensing.com>
- HD Radio Technology manufactured under license from iBiquity Digital Corporation. U.S. and Foreign Patents. HD Radio and the HD, HD Radio, and “Arc” logos are proprietary trademarks of iBiquity Digital Corp.



- Pandora, the Pandora logo, and the Pandora trade dress are trademarks or registered trademarks of Pandora Media, Inc., used with permission. Pandora is currently available exclusively in the United States.
- Sirius, XM and all related marks and logos are trademarks of Sirius XM Radio Inc. All rights reserved.
- Android is a trademark of Google Inc.

## **CYBERSECURITY**

Your vehicle may be a connected vehicle and may be equipped with both wired and wireless networks. These networks allow your vehicle to send and receive information. This information allows systems and features in your vehicle to function properly.

Your vehicle may be equipped with certain security features to reduce the risk of unauthorized and unlawful access to vehicle systems and wireless communications. Vehicle software technology continues to evolve over time and FCA US LLC, working with its suppliers, evaluates and takes appropriate steps as needed. Similar to a computer or other devices, your vehicle may require software updates to improve the usability and performance of your systems or to reduce the potential risk of unauthorized and unlawful access to your vehicle systems.

The risk of unauthorized and unlawful access to your vehicle systems may still exist, even if the most recent version of vehicle software (such as Uconnect software) is installed.

**WARNING!**

- It is not possible to know or to predict all of the possible outcomes if your vehicle's systems are breached. It may be possible that vehicle systems, including safety related systems, could be impaired or a loss of vehicle control could occur that may result in an accident involving serious injury or death.
- **ONLY** insert media (e.g., USB, SD card, or CD) into your vehicle if it came from a trusted source. Media of unknown origin could possibly contain malicious software, and if installed in your vehicle, it may increase the possibility for vehicle systems to be breached.
- As always, if you experience unusual vehicle behavior, take your vehicle to your nearest authorized dealer immediately.

**NOTE:**

- FCA or your dealer may contact you directly regarding software updates.
- To help further improve vehicle security and minimize the potential risk of a security breach, vehicle owners should:
  - Routinely check [www.driveuconnect.com/software-update](http://www.driveuconnect.com/software-update) to learn about available Uconnect software updates.
  - Only connect and use trusted media devices (e.g. personal mobile phones, USBs, CDs).

Privacy of any wireless and wired communications cannot be assured. Third parties may unlawfully intercept information and private communications without your consent. For further information, refer to "Onboard Diagnostic System (OBD II) Cybersecurity" in "Maintaining Your Vehicle" in your Owner's Manual on the DVD.



# GETTING STARTED

## CONTENTS

---

2

■ GETTING STARTED. . . . .	.20	□ Adjusting Volume . . . . .	.24
□ Turning Power On and Off. . . . .	.21	□ Lowering Volume Quickly . . . . .	.24
□ Source Selection . . . . .	.21	□ Setting The Time And Calendar . . . . .	.25
□ Detaching And Attaching The Front Panel. . . . .	.22	□ Controllable With Remote Control . . . . .	.26
□ Initial System Start-Up. . . . .	.24		

## GETTING STARTED

**WARNING!**

Always drive safely with your hands on the steering wheel and obey all applicable laws. You have full responsibility and assume all risks related to the use of the features and applications in this vehicle. Only use the features and applications in this vehicle when it is safe to do so. Failure to do so may result in an accident involving in serious injury or death.

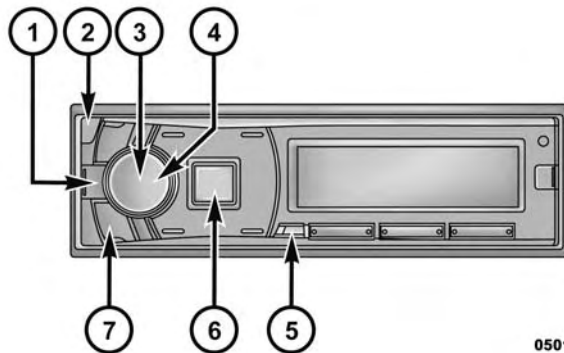

0501067419



- 1 — ON/OFF/Return
- 2 — Front Panel Release
- 3 — Rotary Encoder
- 4 — /ENTER

- 5 — MUTE
- 6 — /Source
- 7 — AUDIO/SETUP

## Turning Power On and Off

Press  to turn on the unit.

### NOTE:

- The unit can be turned on by pressing any other button except .
-  /SOURCE key blinks each time the unit is powered on.

Press and hold  for at least 2 seconds to turn off the unit.

### NOTE:

- The first time power is turned on, the volume will start from level 12.

## Source Selection

Press  /SOURCE to change the source.

HD Radio → SiriusXM\*1 → Disc → USB/iPod\*2 → BLUETOOTH Audio\*3 → PANDORA\*4 → Auxiliary\*5 → HD Radio

\*1 Displayed only when a SiriusXM Tuner is connected.

\*2 Displayed only when the iPod/iPhone is connected.

\*3 Displayed only when Bluetooth IN is set to ON, refer to “Setting The BLUETOOTH Connection (Bluetooth IN)” on page 114.

\*4 Not displayed when Alpine APP is set to OFF, refer to “Setting The Communication Mode With A Smartphone (Alpine APP)” on page 106.

\*5 Displayed only when the AUX IN is set to ON, refer to “Setting The AUX SETUP Mode” on page 91.

## Detaching And Attaching The Front Panel

### Detaching

1. Turn off the unit power.
2. Press  (OPEN) to open the front panel  
To close the front panel, press the left side until it locks.

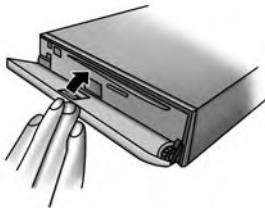

0501067420

3. Grasp the front panel firmly, slide to the left (1), and then pull to remove (2).

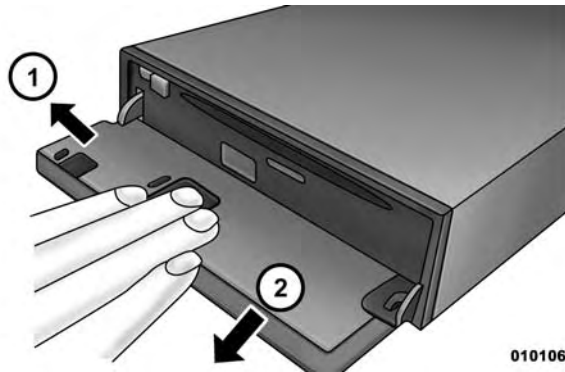

0101068313

**NOTE:**

- The front panel may become hot in normal usage (especially the connector terminals on the back of the front panel). This is not a malfunction.
- To protect the front panel, place it in the supplied carrying case.
- When detaching the front panel, do not apply excessive force as it may result in a malfunction.
- Do not leave the front panel open, or drive the car with the panel open as it may result in an accident or malfunction.

**Attaching**

1. Insert the right side of the front panel into the main unit. Align the groove on the front panel with the projections on the main unit (1).

2. Push the left side of the front panel until it locks firmly into the main unit (2).

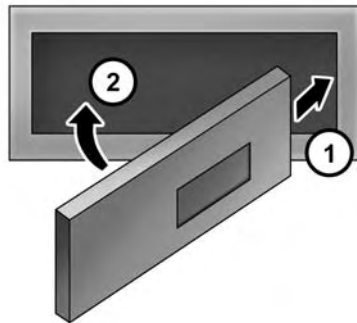

0101068314

**NOTE:**

- Before attaching the front panel, make sure that there is no dirt or dust on the connector terminals and no foreign objects between the front panel and the main unit.



## 24 GETTING STARTED

- Attach the front panel carefully, holding the sides of the front panel to avoid pushing buttons by mistake.

### Initial System Start-Up

**NOTE:** Be sure to press the RESET button when using the unit for the first time, after changing the car battery, or using the battery disconnect (anytime the vehicle loses power).

To reset the system, perform the following procedure:

1. Turn off the unit.
2. Press  (OPEN) to open the front panel, and then remove it.
3. Press RESET button (1) with a ballpoint pen or similar pointed object.



0101068312

### Adjusting Volume



Turn the Rotary encoder until the desired sound level is obtained.

### Lowering Volume Quickly

Activating the Audio Mute function will instantly lower the volume level by 20 dB.



1. Press MUTE to activate the MUTE mode.  
The audio level will decrease by about 20 dB.
2. Pressing MUTE again will return the audio back to its previous level.

### Setting The Time And Calendar

1. Press and hold AUDIO/SETUP for at least 2 seconds to activate the SETUP selection mode.
2. Turn the Rotary encoder to select the General mode, and then press  /ENTER.
3. Turn the Rotary encoder to select Clock Adjust, and then press  /ENTER.
4. Turn the Rotary encoder to set year.
5. Press  /ENTER.
6. Repeat steps 4 and 5 above to set month, date, hour and minute.

7. Press and hold AUDIO/SETUP for at least 2 seconds to return to normal mode.

#### NOTE:

- Pressing  returns to the previous SETUP mode.
- If no operation is performed for 60 seconds, SETUP is canceled.
- To synchronize the clock to another clock/watch or radio time announcement, press and hold  /ENTER for at least 2 seconds after setting the “hour.” Minutes will reset to 00. If the display shows over “30” minutes when you do this, the time will advance one hour.

### Controllable With Remote Control

This unit can be controlled with an optional Alpine remote control. For details, consult your Alpine dealer. Point the optional remote control transmitter at the remote-control sensor (1).

With an optional Alpine Steering Wheel Remote Control Interface Box, this unit is controllable from the vehicles steering wheel controls. For details, contact your Alpine dealer.

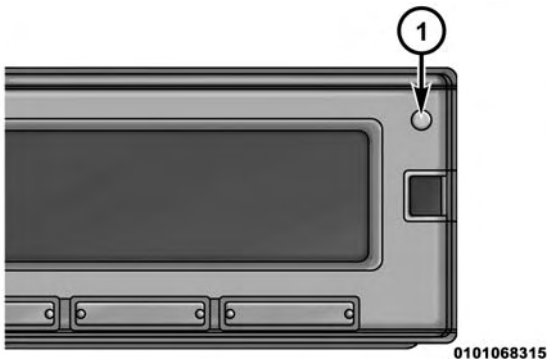

Connectable to Remote Control Interface Box

# HD RADIO

## CONTENTS

---

■ HD RADIO . . . . .	.28	□ Frequency Search Function. . . . .	.31
□ Listening To Radio . . . . .	.29	□ Receiving A Multicast Station. . . . .	.32
□ Presetting Stations Manually . . . . .	.30	□ Multicast Station Search. . . . .	.34
□ Presetting Stations Automatically . . . . .	.30	□ Storing The Tag Information. . . . .	.34
□ Tuning To Preset Stations . . . . .	.31	□ About The Feature Logos. . . . .	.36

## HD RADIO

**WARNING!**

Always drive safely with your hands on the steering wheel and obey all applicable laws. You have full responsibility and assume all risks related to the use of the features and applications in this vehicle. Only use the features and applications in this vehicle when it is safe to do so. Failure to do so may result in an accident involving in serious injury or death.

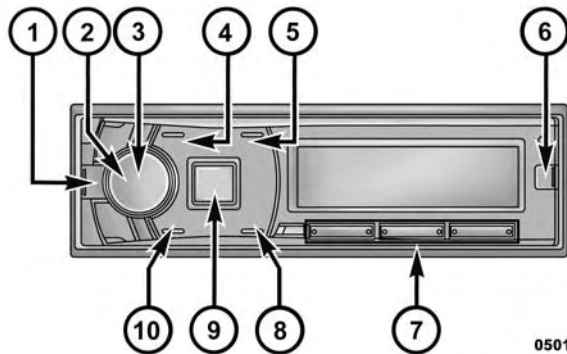

0501067424

- 1 — ON/OFF/Return
- 2 — Rotary Encoder
- 3 — /ENTER
- 4 — Fast Rewind
- 5 — Fast Forward
- 6 — VIEW/Tag

- 7 — Preset Buttons  
(1 through 6)
- 8 — BAND
- 9 — SOURCE
- 10 — TUNE/A.M.E

This unit is able to receive signals based on the terrestrial digital radio broadcasting standard.

When current AM/FM broadcasters are transmitting digital audio and data services, HD Radio signals are on-the-air in their service area. You can receive their digital broadcast and enjoy high quality sound.

Depending on the Listen Mode setting, this unit will tune to either the Digital or Analog signals. For details, please refer to “Switching The Listening Mode” on page 101.

While receiving a live, HD Radio broadcast, you can switch to either the Digital or Analog signal for listening. For details, refer to “Setting The Live mode (Live Mode)” on page 102.

### Listening To Radio

1. Press  /SOURCE to select HD Radio mode.

2. Press BAND repeatedly until the desired radio band is displayed.

FM1 → FM2 → AM → FM1

3. Press TUNE/A.ME to select the tuning mode.

DX (Distance mode) → LOCAL (Local mode) → MANUAL (Manual mode) → DX

3

#### NOTE:

- The initial mode is Distance mode.

#### Distance mode:

Both strong and weak stations will be automatically tuned in (Automatic Seek Tuning).

#### Local mode:

Only strong stations will be automatically tuned in (Automatic Seek Tuning).

**Manual mode:**

The frequency is manually tuned in steps (Manual tuning).

4. Press ◀◀ or ▶▶ to tune in the desired station.

Holding down ◀◀ or ▶▶ will change the frequency continuously.

**NOTE:**

- If SEEK type is set to Digital, only Digital HD Radio stations are found using the SEEK UP/DOWN function. Refer to “Setting The Digital Seek” on page 100.

**Presetting Stations Manually**

1. Select the radio band and tune in a desired radio station you wish to store in the preset memory.
2. Press and hold, for at least 2 seconds, any one of the preset buttons (1 through 6) into which you wish to store the station.

The selected station is stored.

The display shows the band, preset number and station frequency memorized.

**NOTE:**

- A total of 18 stations can be stored in the preset memory (6 stations for each band; FM1, FM2 and AM).
- If you store a station in a preset memory which already has a station, the current station will be cleared and replaced with the new station.

**Presetting Stations Automatically**

1. Press BAND repeatedly until the desired radio band is displayed.
2. Press and hold TUNE/A.ME for at least 2 seconds.

The tuner will automatically seek and store 6 strong stations in the selected band. They will be stored into preset buttons 1 to 6 in order of signal strength.

When the automatic memory has been completed, the tuner goes to the station stored in preset location No.1.

**NOTE:**

- If no stations are stored, the tuner returns to the station you were listening to before the auto memory procedure began.
- Sub-program service of Multicast stations are not included in the automatic memory search.

**Tuning To Preset Stations**



1. Press BAND repeatedly until the desired band is displayed.
2. Press any one of the station preset buttons (1 through 6) that has your desired radio station in memory.  
The display shows the band, preset number and frequency of the station selected.

**NOTE:**

- If the digital signal for any service becomes weak, none of the digital features are available. For example, a Multicast channel recalled from preset memory will revert to the Main Program Service with loss of the digital signal (“Signal Loss” is displayed). Upon return of the digital signal strength, the tuner will resume playback of the Multicast channel.

**Frequency Search Function**

You can search for a radio station by its frequency.

1. Press  /ENTER in Radio mode to activate the search mode.
2. Turn the Rotary encoder to select “Frequency SEARCH”, and then press  /ENTER to enter the frequency search mode. \*



\* Operation is not required when Listen Mode is set to Analog (refer to “Switching The Listening Mode”) on page 101.

3. Turn the Rotary encoder to select the desired frequency.
4. Press  /ENTER to receive the selected frequency.

**NOTE:**



- Press  in the search mode to cancel. Or, the search mode will be canceled if no operation is performed for 60 seconds.

**Receiving A Multicast Station**

Multicasting is the ability to broadcast multiple program streams over a single FM frequency. This increases the amount and diversity of content choices. A maximum of eight (8) multicast station channels can be selected on this unit.

**NOTE:**

- Make sure Listen Mode is set to other than Analog (refer to “Switching the listening mode” on page 101).

When multicast station is received, the program number and the Multicast indicator lights up. Press  or  to select the desired program service.\*

Receiving the Multicast Station Program Service.

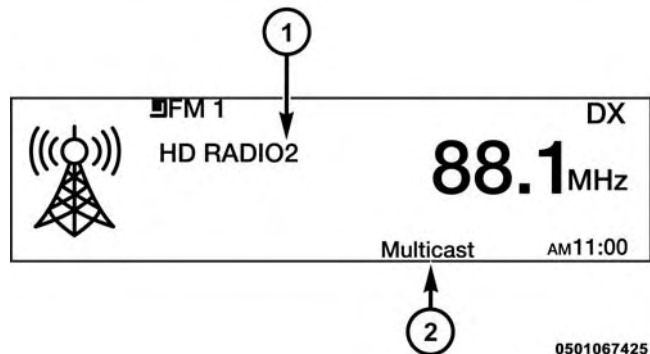

- 1 — Program No.
- 2 — Multicast Indicator

Program Service example:



Multicast Radio Station	Program No.	Program Service
88.1 MHz	1	Main Program Service
88.1 MHz	2	Sub-program Service
88.1 MHz	3	Sub-program Service
88.1 MHz		
88.1 MHz		
88.1 MHz		
88.1 MHz		
88.1 MHz	8	Sub-program Service

\* This operation can be performed only when Multi Cast Seek is set to ON (refer to "Setting The Multicast Seek" on page 99).

## Multicast Station Search

If a frequency has a Multicast station broadcast, the Multicast indicator lights up. Use the Multicast search mode to select a desired program from the Multicast stations available.

### NOTE:

- Make sure Listen Mode is set to other than Analog (refer to “Switching The Listening Mode” on page 101).
1. Choose a frequency with the Multicast indicator on.
  2. Press  /ENTER to activate the search mode.
  3. Turn the Rotary encoder to select Multi Cast Search, and then press  /ENTER to enter the Multicast search mode.
  4. Turn the Rotary encoder to select the desired station, and then press  /ENTER. The selected station is received.

### NOTE:

- Press  VIEW at step 4. You can change the display between station name, song name, artist name and program type.
- The search mode will be canceled if no operation is performed for 60 seconds.

## Storing The Tag Information

iTunes Tagging lets you tag songs heard on HD Radio stations. You can preview, buy and download later, songs from your iTunes tagged playlist the next time you sync your iPod/iPhone. If the unit is connected to a Tagging compatible iPod/iPhone, you can use the iTunes Tagging function. For details, refer to the Owner’s Manual of the Tagging compatible iPod/iPhone.

The Tag indicator will light when a song playing on an HD Radio station has tag information available.

Press and hold  /Tag to save its tag information.

If no iPod/iPhone is connected, "Tag Count X" is displayed (X is the total amount of the tag information stored in this unit).

#### NOTE:

- During tagging, the iPod/iPhone takes priority to save the tag information. If no iPod/iPhone is connected, the tag information is saved to this unit.
- When the memory of iPod/iPhone is full, "iPod Full" and "Tag Count X" are displayed. The tag information will be stored to the unit.
- If the operation is failed, "Cannot Tag" is displayed.

- This unit can store up to 50 pieces of tag information. When the memory of the unit is full, "Tag Count50" and "Memory Full" may be displayed.
- When an iPod that doesn't support the tagging function is connected, "Non-Tagging iPod" may be displayed.
- When the iPod/iPhone is disconnected from the unit during tagging, its tag information will be stored in the unit.
- If there is stored tag information on the unit, when an iPod/iPhone supporting the tag function is connected, the stored tag information will be transferred to the iPod/iPhone automatically. When the iPod/iPhone memory becomes full, "iPod Full" will be displayed, and any remaining tag information on the unit will not be transferred to the iPod/iPhone.

- If tag information already exists, “Already Tagged” will be displayed when you try to tag information again.

### **About The Feature Logos**

#### **Digital Sound )**

- Digital, CD-quality sound. HD Radio Technology enables local radio stations to broadcast a clean digital signal. AM sounds like today’s FM and FM sounds like a CD.

#### **PSD )**

- Program Service Data: Contributes to the superior user experience of HD Radio Technology. Presents song name, artist, station IDs, HD2/ HD3 Channel Guide, and other relevant data streams.

#### **HSD2/HD3 )**

- Adjacent to traditional main stations are extra local FM channels. These HD2/HD3 Channels provide new, original music as well as deep cuts into traditional genre.

#### **iTunes Tagging )**

- iTunes Tagging provides you the opportunity to discover a wide range of content and the means to “tag” that content for later review and purchase from the iTunes Store.

# CD/MP3/WMA/AAC

## CONTENTS

---

■ CD/MP3/WMA/AAC . . . . .	.38	□ Folder/File Name Search (Concerning MP3/WMA/AAC) . . . . .	.41
□ Playback. . . . .	.39	□ Search Position Memory . . . . .	.43
□ Repeat Play . . . . .	.40	□ About MP3/WMA/AAC . . . . .	.44
□ M.I.X. (Random Play) . . . . .	.40		
□ Searching For CD Text. . . . .	.41		

## CD/MP3/WMA/AAC

**WARNING!**

Always drive safely with your hands on the steering wheel and obey all applicable laws. You have full responsibility and assume all risks related to the use of the features and applications in this vehicle. Only use the features and applications in this vehicle when it is safe to do so. Failure to do so may result in an accident involving in serious injury or death.

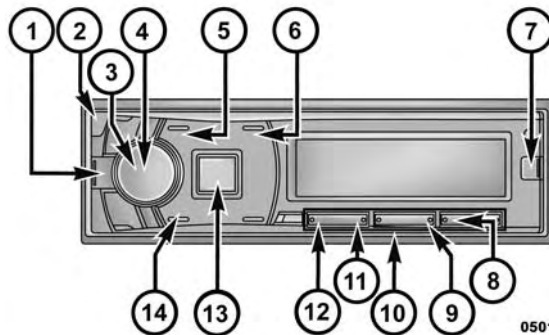

0501067426

- 1 — ON/OFF/Return
- 2 — Front Panel Release
- 3 — Rotary Encoder
- 4 — /Enter
- 5 — Fast Rewind
- 6 — Fast Forward
- 7 — View
- 8 — Random

- 9 — Repeat
- 10 — Preset Buttons  
(1 through 6)
- 11 — Forward
- 12 — Rewind
- 13 — Source
- 14 — Play/Pause

## Playback

1. Press  (OPEN).

The front panel will open.

2. Insert a disc with the label side facing up.



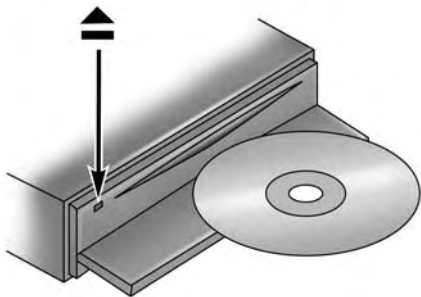









The disc will be pulled into the unit automatically.



0501067427

3. Close the front panel manually.

### NOTE:

- When a disc is already inserted, press  /SOURCE to switch to the Disc mode.
4. While playing back MP3/WMA/AAC, press Rewind  or  Forward to select the desired folder.  
Pressing and holding Rewind  or  Forward will change folders continuously.
  5. Press  or  to select the desired track (file).  
Pressing and holding  or  will fast backward/fast forward track continuously.
  6. To pause playback, press .  
Pressing  again will resume playback.
  7. After pressing  (OPEN) to open the front panel, press  to eject the disc.



**NOTE:**

- Do not remove a CD during its eject cycle. Do not load more than one disc at a time. A malfunction may result from doing either.
- Three-inch (8 cm) CDs cannot be used.
- Any file protected by DRM (Digital Rights Management) copy protection, cannot be played back on this unit.
- The track display for MP3/WMA/AAC data playback is the file numbers recorded on the disc.
- The playback time may not be correctly displayed when a VBR (Variable Bit Rate) recorded file is played back.
- Press  VIEW to switch the display. For details, refer to “Displaying The Text” on page 74.

**Repeat Play**

1. Press .

The song is played back repeatedly.

RPT\*1 → RPT  \*2 → (off) → RPT

\*1 Only a track/file is repeatedly played back.

\*2 Only files in a folder are repeatedly played back (MP3/WMA/ AAC mode only).

2. To cancel repeat play, select (off) with the above procedure.

**M.I.X. (Random Play)**

1. Press .

The songs are played back in random sequence.

MIX  \*1 → MIX ALL\*2 → (off) → MIX 



\*1 Only files in a folder are played back in random sequence (MP3/ WMA/AAC mode only).

\*2 The tracks/files are played back in random sequence.

2. To cancel M.I.X. play, select (off) with the above procedure.

### Searching For CD Text

On discs utilizing CD Text, songs can be searched and played by using their recorded titles. For discs without CD Text, searches are made using the track numbers associated with each song.

1. Press  /ENTER during play.  
This will set the search mode.
2. Turn the Rotary encoder to select the desired track, and then press  /ENTER.  
This will play the selected track.



### NOTE:

- Press  in the search mode to cancel. Or, the search mode is canceled if no operation is performed for 60 seconds.
- When CD Text Search is made during M.I.X. play, the M.I.X. play mode will be canceled.
- If any one of the preset buttons (1 through 6) is pressed in the search mode, a search can be made quickly by skipping to the specified location. For details, refer to “Direct Search Function” on page 153.



### Folder/File Name Search (Concerning MP3/WMA/AAC)

Folder and file names may be searched and displayed during playback.



### Folder Name Search Mode

1. During MP3/WMA/AAC playback, press  /ENTER to activate the search mode.
2. Turn the Rotary encoder to select Folder Name Search mode, and then press  /ENTER.
3. Turn the Rotary encoder to select the desired folder.
4. Press and hold  /ENTER for at least 2 seconds to play back the first file in the selected folder.

#### NOTE:

- If no operation is performed for 60 seconds, the search mode is canceled.
- Press  in the search mode to return to the previous mode.
- To search for files in the Folder Name Search mode, press  /ENTER. Files in the folder may be searched.
- Press  to exit Folder Name Search mode in step 3 to select File Name Search mode.
- When Folder Name Search is made during M.I.X. play, the M.I.X. play mode will be canceled.
- The root folder of a disc is displayed as “\ROOT”.
- If any one of the preset buttons (1 through 6) is pressed in the search mode, a search can be made quickly by skipping to the specified location. For details, refer to “Direct Search Function” on page 153.

## File Name Search Mode

1. During MP3/WMA/AAC playback, press  /ENTER to activate the search mode.
2. Turn the Rotary encoder to select File Name Search mode, and then press  /ENTER.
3. Select the desired file by turning the Rotary encoder.
4. Press  /ENTER to play back the selected file.

### NOTE:

- If no operation is performed for 60 seconds, the search mode is canceled.
- Press  in the search mode to return to the previous mode.

- When File Name Search is made during M.I.X. play, the M.I.X. play mode will be canceled.
- If any one of the preset buttons (1 through 6) is pressed in the search mode, a search can be made quickly by skipping to the specified location. For details, refer to “Direct Search Function” on page 153.

## Search Position Memory

During playback, you can quickly return to the last-selected hierarchy level in the search mode.

Press .

The hierarchy you selected last in the search mode is displayed.

## About MP3/WMA/AAC

### CAUTION!

Except for private use, duplicating audio data (including MP3/ WMA/AAC data) or distributing, transferring, or copying it, whether for free or for a fee, without permission of the copyright holder is strictly prohibited by the Copyright Act and by international treaty.

### What is MP3?

MP3, whose official name is “MPEG Audio Layer 3,” is a compression standard prescribed by the ISO, the International Standardization Organization and MPEG which is a joint activity institution of the IEC. MP3 files contain compressed audio data. MP3 encoding is capable of compressing audio data at extremely high ratios, reducing the size of music files to as much as

one-tenth their original size. This is achieved while still maintaining near CD quality. The MP3 format realizes such high compression ratios by eliminating the sounds that are either inaudible to the human ear or masked by other sounds.

### What is WMA?

WMA, or “Windows Media Audio,” is compressed audio data. WMA is similar to MP3 audio data.

### What is AAC?

AAC is the abbreviation for “Advanced Audio Coding”, and is a basic format of audio compression used by MPEG2 or MPEG4.

### Method for creating MP3/WMA/AAC files

Audio data is compressed using software with MP3/ WMA/AAC codecs. For details on creating MP3/ WMA/AAC files, refer to the user’s manual for that software.

MP3/WMA/AAC files that are playable on this device have the file extensions “mp3”/“wma”/“m4a”. Files with no extension cannot be played back (WMA ver. 7, 8 and 9 are supported). Protected files are not supported, neither are raw AAC files (using the “.aac” extension). There are many different versions of the AAC format. Confirm that the software being used conforms to the acceptable formats listed above. It’s possible that the format may be unplayable even though the extension is valid.

Playback of AAC files encoded by iTunes is supported.

### Supported playback sampling rates and bit rates

MP3	
Sampling rates:	48 kHz, 44.1 kHz, 32 kHz, 24 kHz, 22.05 kHz, 16 kHz, 12 kHz, 11.025 kHz, 8 kHz
Bit rates:	8 - 320 kbps
WMA	
Sampling rates:	48 kHz, 44.1 kHz, 32 kHz
Bit rates:	32 - 192 kbps
AAC	
Sampling rates:	48 kHz, 44.1 kHz, 32 kHz, 24 kHz, 22.05 kHz, 16 kHz, 12 kHz, 11.025 kHz, 8 kHz
Bit rates:	16 - 320 kbps

This device may not play back correctly depending on sampling rates. In the USB mode, the playback time may not be correctly displayed when a VBR (Variable Bit Rate) recorded file is played back.

### **ID3 tags/WMA tags**

This device supports ID3 tag v1 and v2, and WMA/AAC tag. If tag data is in an MP3/WMA/AAC file, this device can display the title (track title), artist name, and album name ID3 tag/WMA/AAC tag data. This device can only display single-byte alphanumeric characters (up to 32 for ID3 tags and up to 32 for WMA tags) and the underscore. For non-supported characters, "No Support" is displayed or the character is displayed as space.

If information contains characters other than ID3 tag information, the audio file may not be played back.

The tag information may not be correctly displayed, depending on the contents.

### **Playing back MP3/WMA/AAC**

MP3/WMA/AAC files are prepared, then written to a CD-R, CD-RW using CD-R writing software or stored to a Flash Memory. A disc can hold up to 509 files/folders (including Root Folders), and the maximum number of folders is 255.

Playback may not be performed if a disc exceeds the limitations described above.

### **Media supported**

The media that this device can play back are CD-ROMs, CD-Rs, and CD-RWs.

This device also can play back Flash Memory media.

### **Corresponding File Systems**

This device supports discs formatted with ISO9660 Level 1 or Level 2. Under the ISO9660 standard, there are some restrictions to remember. The maximum

nested folder depth is 8 (including the root directory). The number of characters for a folder/file name is limited.

Valid characters for folder/file names are letters A-Z (all caps), numbers 0-9, and ' \_ ' (underscore).

This device also can play back discs in Joliet, Romeo, etc., and other standards that conform to ISO9660. However, sometimes the file names, folder names, etc., are not displayed correctly.

This device also supports FAT 12/16/32 for Flash Memory device.

### **Formats supported**

This device supports CD-ROM XA, Mixed Mode CD, Enhanced CD (CD-Extra) and Multi-Session.

This device cannot correctly play back discs recorded with Track At Once or packet writing.

### **Order of files**

Files are played back in the order that the writing software writes them to the disc. Therefore, the playback order may not be what is expected. Verify the writing order in the software's documentation. The playback order of the folders and files is as follows.



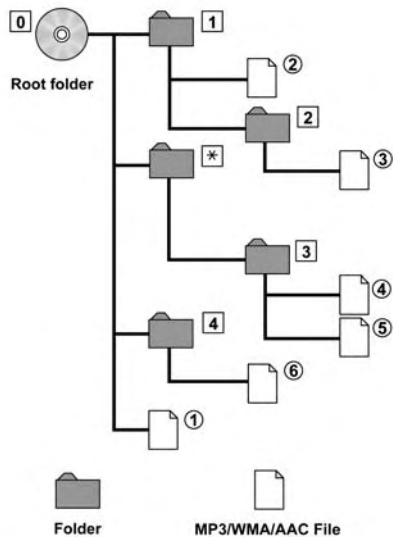

\* The folder No./ folder Name will not be displayed if no file is contained in the folder.

## Terminology

### Bit rate

This is the “sound” compression rate specified for encoding. The higher the bit rate, the higher the sound quality, but also the larger the files.

### Sampling rate

This value shows how many times per second the data is sampled (recorded). For example, music CDs use a sampling rate of 44.1 kHz, so the sound is sampled (recorded) 44,100 times per second. The higher the sampling rate, the higher the sound quality, but also the larger the volume of data.

## Encoding

Converting music CDs, WAVE (AIFF) files, and other sound files into the specified audio compression format.

## Tag

Song information such as track titles, artist names, album names, etc., written into MP3/WMA/AAC files.

## Root folder

The root folder (or root directory) is found at the top of the file system. The root folder contains all folders and files. It is created automatically for all burned discs.



# SOUND SETTING

## CONTENTS

---

■ SOUND SETTING . . . . .	.52	□ About “Text” . . . . .	.79
□ Adjusting Subwoofer Level/Bass Level/Treble Level/Balance (Between Left And Right)/Fader (Between Front And Rear)/Defeat. . . . .	.52	□ Option Menu Setting . . . . .	.80
□ Audio Setup . . . . .	.53	□ Applying TuneIt . . . . .	.83
□ About Time Correction . . . . .	.63	□ Adjusting The Sound Via Smartphone. . . . .	.84
□ About The Crossover. . . . .	.70	□ Facebook Notification Function. . . . .	.85
■ OTHER FUNCTIONS. . . . .	.74	□ Receiving Notification (Ready On Future Update) . . . . .	.85
□ Displaying The Text. . . . .	.74	□ Displaying Notification List (Ready On Future Update) . . . . .	.86
□ About The Indication Display. . . . .	.78		

## SOUND SETTING

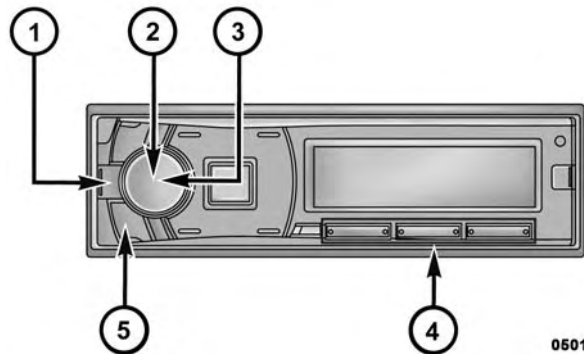

0501067428

1 — ON/OFF/Return  
 2 — Rotary Encoder  
 3 — /Enter

4 — Preset Buttons  
 (1 through 6)  
 5 — Audio/Setup

### Adjusting Subwoofer Level/Bass Level/Treble Level/Balance (Between Left And Right)/Fader (Between Front And Rear)/Defeat

1. Press AUDIO repeatedly to choose the desired mode. Each press changes the mode as follows:

SubW LEVEL\*1 → BASS\*2 → TREBLE\*2 → BALANCE  
 → FADER → DEFEAT → VOLUME → SubW LEVEL

\*1 When the Subwoofer mode is set to OFF, its level cannot be adjusted, refer to "Turning Subwoofer ON/OFF" on page 57.

\*2 Adjustable only when DEFEAT is OFF.

Subwoofer Level	0 ~ 15
Bass Level	-7 ~ 7
Treble Level	-7 ~ 7
Balance	-15 (L) ~ 15 (R)

Fader	-15 (R) ~ 15 (F)
Defeat	ON/OFF
Volume	0 ~ 35

**NOTE:**

- If no operation is performed for 5 seconds after selecting the SubW LEVEL, BASS, TREBLE, BALANCE, FADER, DEFEAT or VOLUME mode, the unit automatically returns to normal mode.
2. Turn the Rotary encoder until the desired sound is obtained in each mode.

**NOTE:**

- By setting DEFEAT ON, previously adjusted level settings of BASS and TREBLE will return to the factory defaults.

**Audio Setup**

You can flexibly customize the unit to suit your own preference and usage. From the AUDIO SETUP menu, Audio Setting can be modified.

Use steps 1 to 5 to select the category you wish to modify. For details on how to change each setting, see the following sections below.

1. Press and hold AUDIO/SETUP for at least 2 seconds to activate the SETUP mode.
2. Turn the Rotary Encoder to select Audio, and then press  /ENTER.

Audio\*1 ↔ General ↔ Display ↔ Tuner ↔  
 SiriusXM\*2 ↔ iPod&USB ↔ Application ↔ Bluetooth  
 ↔ Audio

\*1 Adjustment cannot be performed during a call.

\*2 Displayed only when a SiriusXM Tuner is connected.

3. Turn the Rotary Encoder to select the desired sound setting menu, and then press  /ENTER.

Factory's EQ\*3/\*4 ↔ Parametric EQ\*3/\*5 ↔ VOL LV ADJ ↔ Subwoofer ↔ Subwoofer Phase\*6 ↔ Subwoofer System\*6 ↔ Power IC ↔ MX Setup\*3 ↔ TCR Parameter\*3 ↔ T.Correction\*3 ↔ Spatial\*3 ↔ X-Over\*3 ↔ Factory's EQ

\*3 Adjustment cannot be performed when DEFEAT is set to ON.

\*4 Any changes made to either Factory's EQ or Parametric EQ are reflected in the others' settings.

\*5 In step 3, nine sound adjustment items can be selected in Parametric EQ mode. Turn the Rotary encoder to select the desired item, and then press  /ENTER to continue to step 4.

\*6 These functions are inoperable when Subwoofer is set to OFF.

4. Turn the Rotary Encoder to change the setting, and then press  /ENTER.
5. Press and hold AUDIO/SETUP for at least 2 seconds to return to normal mode.

#### NOTE:

- Pressing  returns to the previous Sound menu mode.
- If no operation is performed for 60 seconds, Sound menu mode is canceled.

#### Equalizer Presets (Factory's EQ)

10 typical equalizer settings are preset at the factory for a variety of musical source material. User settings are created in the Parametric EQ mode.

User ↔ Flat (Initial setting) ↔ Pops ↔ Rock ↔ News ↔ Jazz&Blues ↔ Electrical Dance ↔ Hip Hop&Rap ↔ Easy Listening ↔ Country ↔ Classical

#### NOTE:

- The 9 - Band, Parametric EQ is used to create the Factory EQ settings.

### Adjusting The Parametric Equalizer Curve (Parametric EQ)

You can modify the Equalizer settings to create a response curve more appealing to your personal taste.

1. After selecting Parametric EQ from the Audio Setup mode, turn the Rotary Encoder to select the desired band, then press **Q** /Enter.
2. Turn the Rotary Encoder to select the desired frequency within the selected band, then press **Q** /Enter.

3. Repeat step 2 to adjust the Bandwidth and Level within the selected band.

### Adjusting The Band

#### Setting contents:

Band1/Band2/Band3/Band4/Band5/Band6/Band7/  
Band8/Band9

### Adjusting The Frequency (Freq.)

Adjustable frequency bands: 20 Hz to 20 kHz

Band 1	20 Hz ~ 100 Hz (63 Hz)
Band 2	63 Hz ~ 315 Hz (125 Hz)
Band 3	125 Hz ~ 500Hz (250 Hz)
Band 4	250 Hz ~ 1 kHz (500 Hz)
Band 5	500 Hz ~ 2 kHz (1 kHz)
Band 6	1 kHz ~ 4 kHz (2 kHz)



Band 7 7: 2 kHz ~ 7.2 kHz (4 kHz)

Band 8 5.8 kHz ~ 12 kHz (8 kHz)

Band 9 9 kHz ~ 20 kHz (16 kHz)

### Setting The Bandwidth (Q)

#### Setting contents:

3.0 (Initial setting) / 4.0 / 5.0

#### NOTE:

- Settings exceeding the frequency of adjacent bands are not available.
- While adjusting the Parametric EQ, you should consider the frequency response of the connected speakers.
- When the Parametric EQ is adjusted, the adjustment for Factory's EQ becomes ineffective.

- The Parametric EQ setting can be configured when Defeat is OFF.

### Adjusting The Level

#### Setting contents:

-7 to +7 (Initial setting: 0)

#### NOTE:

- Band 2 and Band 8 are the same as the Bass and Treble controls. Their Level adjustment can also be controlled by pressing AUDIO and selecting Bass Level or Treble Level. Refer to "Adjusting Subwoofer Level/Bass Level/Treble Level/Balance (Between Left and Right)/Fader (Between Front and Rear)/Defeat" on page 52.
- Settings exceeding the frequency of adjacent bands are not available.

- While adjusting the Parametric EQ, you should consider the frequency response of the connected speakers.
- The Parametric EQ is used to create the Factory's EQ settings.

### Setting The Source Volume Level

The output level of each source is individually adjustable. For example, if the Tuner level sounds lower than Disc, its output can be adjusted without affecting the other sources.

- **Setting item:** VOL LV ADJ
- **Further setting items:** Tuner / SiriusXM / Disc / USB / iPod / BTAudio / Pandora / AUX

#### Setting contents:

-14 dB ~ +14 dB

### Turning Subwoofer ON/OFF

When the subwoofer is on, you can adjust the subwoofer output level (refer to "Adjusting Subwoofer Level/Bass Level/Treble Level/Balance (Between Left and Right)/Fader (Between Front and Rear)/Defeat" on page 52.

- **Setting item:** Subwoofer

#### Setting contents:

OFF/ON (Initial setting)

**OFF:** No subwoofer signal is output from the Subwoofer RCA Connector.

**ON:** The subwoofer signal is output from the Subwoofer RCA Connector.

### Setting The Subwoofer Phase

The subwoofer output phase is toggled Subwoofer Normal (0°) or Subwoofer Reverse (180°). To adjust the level, turn the Rotary Encoder.

- **Setting item:** Subwoofer Phase

**Setting contents:**

0° (Initial setting) / 180°

### Setting The Subwoofer System

When the subwoofer is on, you can select either System 1 or System 2 for the desired subwoofer effect.

- **Setting item:** Subwoofer System

**Setting contents:**

System 1/ System 2 (Initial setting)

#### System 1:

Subwoofer level changes according to the main volume setting.

#### System 2:

Subwoofer level change is different from the main volume setting. For example, even at low volume settings, the subwoofer is still audible.

### Setting The Media Xpander Mode (MX Setup)

MX (Media Xpander) makes vocals or instruments sound distinct regardless of the music source. The CD and iPod, etc. will be able to reproduce the music clearly even in cars with a lot of road noise.

- **Setting item:** MX Setup

1. Turn the Rotary Encoder to select the source to which you want to apply Media Xpander, and then press  /ENTER.

Analog Tuner ↔ HD1 ↔ HD2 ↔ HD3&Other ↔  
SiriusXM ↔ CD ↔ CMPM ↔ USB ↔ iPod ↔ BT  
Audio ↔ Pandora ↔ AUX

\* Be applied for MP3/WMA/AAC files in disc.

- Turn the Rotary Encoder to select the Media Xpander level, and then press  /ENTER.

OFF ↔ Level 1 ↔ Level 2 ↔ Level 3 ↔ Customize

### Customizing The Media Xpander Setting

If Customize is selected in step 2, you can modify the Media Xpander to suit your personal preference.

- Turn the Rotary Encoder to select the Band, and then press  /ENTER. Band 1 (Low frequencies) Band 3 (High frequencies)

Band 1 (Bass) ↔ Band 2 (Mid) ↔ Band 3 (High)

- Turn the Rotary Encoder to adjust the level, and then press  /ENTER.

LEVEL: 0 ~ 8

- Repeat steps 3 to 4 to complete the setting of other bands.

### Setting The Time Correction Unit (TCR Parameter)

You can change the unit, (cm or inch) of time correction.

- Setting item:** TCR Parameter

#### Setting contents:

cm (Initial setting) / inch

**cm:** Time correction value is in centimeters.

**inch:** Time correction value is in inches.

### Adjusting The Time Correction (T.Correction)

Before performing the following procedures, refer to “About Time Correction” on page 63

- After selecting T.Correction from the Audio Setup mode, turn the Rotary Encoder to select a speaker to be adjusted, and then press  /ENTER.

## 60 SOUND SETTING

F-L\*1 ↔ F-R\*2 ↔ R-L\*3 ↔ R-R\*4 ↔ SSW-L ↔ SW-R

\*1 Front-L

\*2 Front-R

\*3 Rear-L

\*4 Rear-R

2. Turn the Rotary Encoder to adjust the distance of the selected speaker, and then press  /ENTER.

0.0 cm to 336.6 cm (3.4 cm/step)

0.0 inch to 132.7 inch (1.3 inch/step)

### NOTE:

- The total adjustment distance for all speakers should be less than 510 centimeters (201 inches).

3. Repeat steps 1 and 2 to set another speaker.

By setting these values to make its sound reach the listening position at the same time as the sound of other speakers.



### Adjusting SPATIAL

This function allows you to change the sound field easily. There are three modes to choose from. For details, refer to the table below.

Mode	Effect
OFF (Initial setting)	No effect is applied. OFF status
Front Wide	Creates the effect of widening the front sound field by delaying the sound of the front speakers.
Rear Wide	Creates the effect of making the front sound image clear and far by delaying the sound of the rear speakers.

### Adjusting The Crossover Settings (X-Over)

Before performing the following procedures, refer to "About the Crossover" on page 70.

1. After selecting X-Over from the Audio Setup mode, turn the Rotary Encoder to select the desired channel, then press  /ENTER.
2. Turn the Rotary Encoder to select the desired frequency within the selected channel, then press  /ENTER.
3. Repeat step 2 to adjust the Slope and Level within the selected channel.

### Adjusting The Channel (Ch.)

#### Setting contents:

Front (HPF) / Rear (HPF) / SUBW (LPF)

### Selecting The Cut-Off Frequency (Freq.)

#### Setting contents:

20 / 25 / 31.5 / 40 / 50 / 63 / 80 (Initial setting) / 100 / 125 / 160 / 200 (Hz)

### Adjusting The Slope

#### Setting contents:

Flat (Initial setting) / 6 / 12 / 18 / 24 dB/oct.

### Adjusting the Level (Lev.)

#### Setting contents:

-12 to 0 (dB) (Initial setting: 0)

- Repeat steps 1 to 2 to make adjustment to the other channels.

### Storing The Parametric EQ/T.Correction/ X-Over Settings

The Parametric EQ/T.Correction and X-Over settings can be stored in the preset memory.

- The Parametric EQ/T.Correction/X-OVER settings can be stored in any one of the preset buttons (1 through 6). After completing any adjustment for Parametric EQ/ T.Correction/X-OVER (e.g. BAND), press and hold the desired preset button for at least 2 seconds.
- Turn the Rotary Encoder to select Protect YES/NO, and then press  /ENTER to store the adjusted contents.

Protect NO ↔ Protect YES (Initial setting)

#### NOTE:

- If Protect YES is selected, the adjusted contents are protected and stored into the preset buttons. When you want to store the parameter into a protected preset button, "Replace NO/YES" can be selected. If Protect NO is selected, the preset is stored.

- While perform this operation, all adjusted contents of Parametric EQ/ T.Correction and X-Over will be stored in the preset buttons.
- The stored contents are not deleted even when resetting the unit or disconnecting the battery.
- The stored contents can be recalled by performing operation (refer to “Recalling the Stored Parametric EQ/T.Correction/X-Over Settings” on page 63).

### Recalling The Stored Parametric EQ/ T.Correction/X-Over Settings

The stored Parametric EQ/T.Correction and X-Over settings are in the preset memory.

1. After selecting any item of the Parametric EQ/ T.Correction/X-Over mode (e.g. Band), press any one of the preset buttons (1 through 6) that has your desired characteristic in memory to recall the stored settings.

The adjusted contents of Parametric EQ/ T.Correction/X-Over stored into the preset button will be demonstrated.

2. Press the preset button again during the demonstration to recall the stored settings.

### About Time Correction

The distance between the listener and the speakers in a car vary widely due to the complex speaker placement. This difference in the distances from the speakers to the listener creates a shift in the sounds image and frequency characteristics. This is caused by the time delay between the sound reaching the listener’s right versus the left ear.

To correct this, this unit is able to delay the audio signal to the speakers closest to the listener. This effectively creates a perception of increased distance for those speakers. The listener can be placed at an equal distance between the left and right speakers for optimum staging.



Listening Position example as follows in this section:

**Example 1: Front Left Seat**

Adjust the time correction level of the front left speaker to a high value and the rear right to zero or a low value.

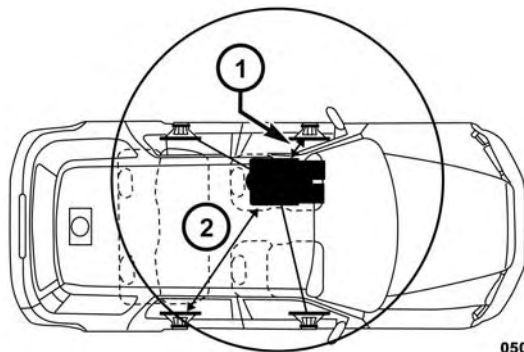

- 1 — 0.5m
- 2 — 2.25m

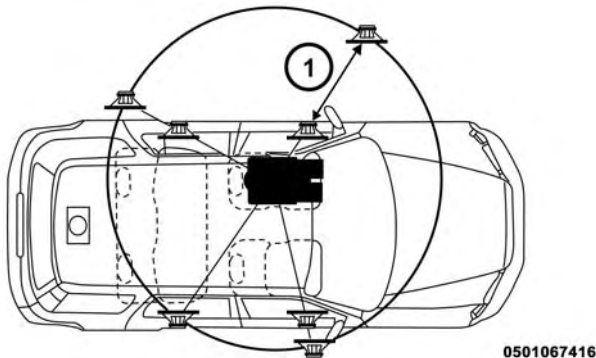

0501067416

1 — 5.1ms

The sound is not balanced because the distance between the listening position and the various speakers is different. The difference in distance between the front left

speaker and the rear right speaker is 1.75 m (68-7/8"). Here we calculate the time correction value for the front left speaker in the diagram on the above.

#### Conditions:

Farthest Speaker - listening position : 2.25 m (88-9/16")

Front left speaker - listening position : 0.5 m (19-11/16")

Calculation:  $L = 2.25 \text{ m} - 0.5 \text{ m} = 1.75 \text{ m} (68-7/8")$

Time correction =  $1.75 \div 343^* \times 1000 = 5.1 \text{ (ms)}$

\* Speed of sound: 343 m/s (765 mph) at 20°C

In other words, giving the front left speaker a time correction value of 5.1 ms makes it seem as if its distance from the listener is the same as the distance to the farthest speaker. Time correction eliminates the differences in the time required for the sound to reach the listening position. The time of the front left speaker is corrected by 5.1

ms so that its sound reaches the listening position at the same time as the sound of other speakers.

### Example 2: All Seats

Adjust the time correction level of each speaker to almost the same level.

1. Sit in the listening position (driver's seat, etc.) and measure the distance (in meters) between your head and the various speakers.
2. Calculate the difference between the distance correction value to the farthest speaker and the other speakers.

$L = (\text{distance to farthest speaker}) - (\text{distance to other speakers})$

These values are the time correction values for the different speakers. Setting these values to make each sound reach the listening position at the same time as the sound of other speakers.

### Time Correction Value List

Delay Number	Time Difference (ms)	Distance (cm)	Distance (inch)
0	0.0	0.0	0.0
1	0.1	3.4	1.3
2	0.2	6.8	2.7
3	0.3	10.2	4.0
4	0.4	13.6	5.4
5	0.5	17.0	6.7
6	0.6	20.4	8.0

Delay Number	Time Difference (ms)	Distance (cm)	Distance (inch)
7	0.7	23.8	9.4
8	0.8	27.2	10.7
9	0.9	30.6	12.1
10	1.0	34.0	13.4
11	1.1	37.4	14.7
12	1.2	40.8	16.1
13	1.3	44.2	17.4
14	1.4	47.6	18.8
15	1.5	51.0	20.1
16	1.6	54.4	21.4
17	1.7	57.8	22.8
18	1.8	61.2	24.1
19	1.9	64.6	25.5

Delay Number	Time Difference (ms)	Distance (cm)	Distance (inch)
20	2.0	68.0	26.8
21	2.1	71.4	28.1
22	2.2	74.8	29.5
23	2.3	78.2	30.8
24	2.4	81.6	32.2
25	2.5	85.0	33.5
26	2.6	88.4	34.8
27	2.7	91.8	36.2
28	2.8	95.2	37.5
29	2.9	98.6	38.9
30	3.0	102.0	40.2
31	3.1	105.4	41.5
32	3.2	108.8	42.9

Delay Number	Time Difference (ms)	Distance (cm)	Distance (inch)
33	3.3	112.2	44.2
34	3.4	115.6	45.6
35	3.5	119.0	46.9
36	3.6	122.4	48.2
37	3.7	125.8	49.6
38	3.8	129.2	50.9
39	3.9	132.6	52.3
40	4.0	136.0	53.6
41	4.1	139.4	54.9
42	4.2	142.8	56.3
43	4.3	146.2	57.6
44	4.4	149.6	59.0
45	4.5	153.0	60.3

Delay Number	Time Difference (ms)	Distance (cm)	Distance (inch)
46	4.6	156.4	61.6
47	4.7	159.8	63.0
48	4.8	163.2	64.3
49	4.9	166.6	65.7
50	5.0	170.0	67.0
51	5.1	173.4	68.3
52	5.2	176.8	69.7
53	5.3	180.2	71.0
54	5.4	183.6	72.4
55	5.5	187.0	73.7
56	5.6	190.4	75.0
57	5.7	193.8	76.4
58	5.8	197.2	77.7

Delay Number	Time Difference (ms)	Distance (cm)	Distance (inch)
59	5.9	200.6	79.1
60	6.0	204.0	80.4
61	6.1	207.4	81.7
62	6.2	210.8	83.1
63	6.3	214.2	84.4
64	6.4	217.6	85.8
65	6.5	221.0	87.1
66	6.6	224.4	88.4
67	6.7	227.8	89.8
68	6.8	231.2	91.1
69	6.9	234.6	92.5
70	7.0	238.0	93.8
71	7.1	241.4	95.1

Delay Number	Time Difference (ms)	Distance (cm)	Distance (inch)
72	7.2	244.8	96.5
73	7.3	248.2	97.8
74	7.4	251.6	99.2
75	7.5	255.0	100.5
76	7.6	258.4	101.8
77	7.7	261.8	103.2
78	7.8	265.2	104.5
79	7.9	268.6	105.9
80	8.0	272.0	107.2
81	8.1	275.4	108.5
82	8.2	278.8	109.9
83	8.3	282.2	111.2
84	8.4	285.6	112.6

Delay Number	Time Difference (ms)	Distance (cm)	Distance (inch)
85	8.5	289.0	113.9
86	8.6	292.4	115.2
87	8.7	295.8	116.6
88	8.8	299.2	117.9
89	8.9	302.6	119.3
90	9.0	306.0	120.6
91	9.1	309.4	121.9
92	9.2	312.8	123.3
93	9.3	316.2	124.6
94	9.4	319.6	126.0
95	9.5	323.0	127.3
96	9.6	326.4	128.6
97	9.7	329.8	130.0

Delay Number	Time Difference (ms)	Distance (cm)	Distance (inch)
98	9.8	333.2	131.3
99	9.9	336.6	132.7

### About The Crossover

#### Crossover (X-Over):

This unit is equipped with an active crossover. The crossover limits the frequencies delivered to the outputs. Each channel is controlled independently. Thus, each speaker pair can be driven by the frequencies for which they have been optimally designed.

The crossover adjusts the HPF (high pass filter) or LPF (low pass filter) of each band, and also the slope (how fast the filter rolls off the highs or lows).

Adjustments should be made according to the reproduction characteristics of the speakers. Depending on the speakers, a passive network may not be necessary. If you are unsure about this point, consult your authorized Alpine dealer.

	Cut-off frequency (1/3 octave steps)		Slope		Level
	HPF	LPF	HPF	LPF	
<b>Low range speaker</b>	—	20 Hz - 200 Hz	—	Flat, 6, 12, 18, 24 dB/ oct.	0 to -12 dB

<b>Rear high range speaker</b>	20 Hz - 200 Hz	—	Flat, 6, 12, 18, 24 dB/ oct.	—	0 to -12 dB
<b>Front high range speaker</b>	20 Hz - 200 Hz	—	Flat, 6, 12, 18, 24 dB/ oct.	—	0 to -12 dB



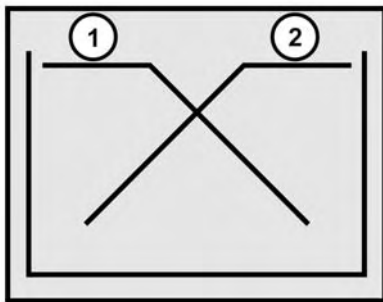

0501067429

- 1 — Low Range  
2 — High Range

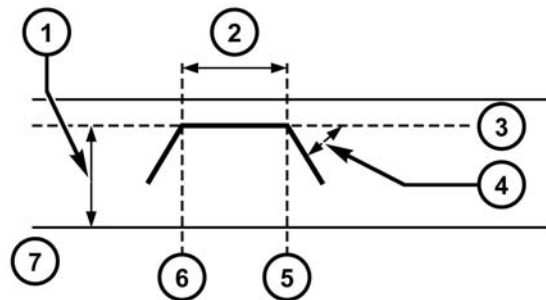

0501067430

- 1 — Level Adjusting (0 to -12 dB)  
2 — Output Frequency Range  
3 — Slope Flat  
4 — Slope Adjusting  
5 — LPF Cut-Off Frequency  
6 — HPF Cut-Off Frequency  
7 — 20 Hz

**NOTE:**

- HPF (high pass filter): Cuts the lower frequencies and allows the higher frequencies to pass.
- LPF (low pass filter): Cuts the higher frequencies and allows the lower frequencies to pass.
- Slope: The level change (in dB) for a frequency change of one octave.
- The higher the slope value, the steeper the slope becomes.
- Adjust the slope to Flat to bypass the HP or LP filters.
- Do not use a tweeter without the HPF on or set to a low frequency, as it may cause damage to the speaker due to the low frequency content.
- You cannot adjust the crossover frequency higher than the HPF or lower than the LPF.
- Adjustment should be made according to the recommended crossover frequency of the connected speakers. Determine the recommended crossover frequency of the speakers. Adjusting to a frequency range outside that recommended may cause damage to the speakers. For the recommended crossover frequencies of Alpine speakers, refer to the respective Owner's Manual. We are not responsible for damage or malfunction of speakers caused by using the crossover outside the recommended value.

## OTHER FUNCTIONS

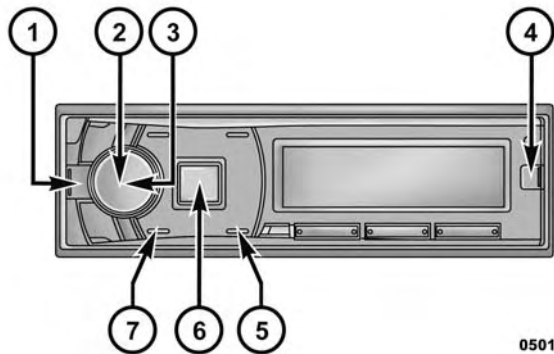

0501067431

- 1 — ⏻ ON/OFF/Return  
 2 — Rotary Encoder  
 3 — 🔍 /Enter  
 4 — 👁 View

- 5 — Band  
 6 — 📺 Source  
 7 — ▶/⏸ Play/Pause

## Displaying The Text

Text information, such as the disc name and the track name, will be displayed if playing a CD text compatible disc. It is also possible to display the folder name, the file name and the tag, etc. while playing MP3/WMA/AAC files.

Press 👁 View.

The display will change every time the button is pressed.

## NOTE:

- When the Text Scroll is set to Manual (refer to “Scroll Setting (Text Scroll)” on page 98), press and hold 👁 View for at least 2 seconds, the current text will be scrolled one time (except Radio mode).

The display in HD Radio mode:

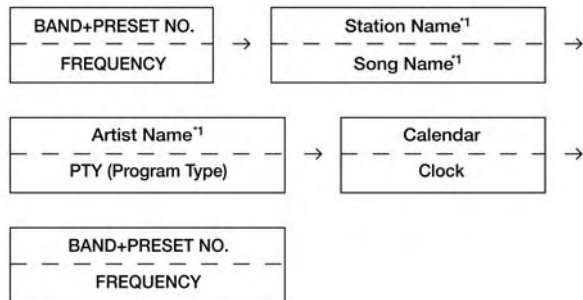

0501067432

The display in CD mode:

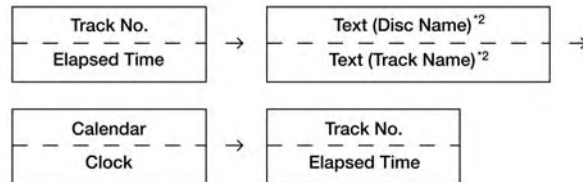

0501067433

The display in MP3/WMA/AAC mode:

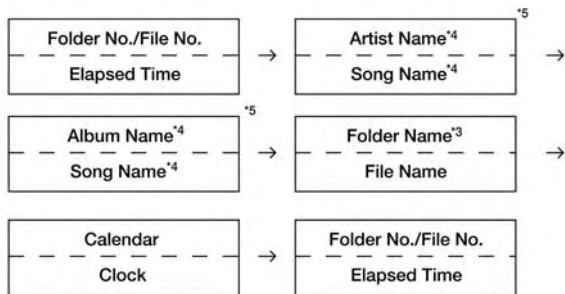

0501067434

The display in BLUETOOTH Audio mode:

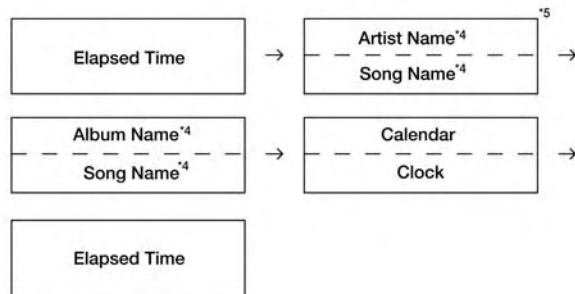

0501067435

\*1 When an HD Radio signal is received, text information such as Radio Station, Artist, etc., is displayed. If there is no text information, nothing will be displayed.

\*2 Displayed during playback of a disc with CD Text. If there is no text information, nothing will be displayed.





\*3 The root folder of disc/Flash Memory is displayed as “\ROOT”. If there is no text information, nothing will be displayed.

\*4 If an MP3/WMA/AAC file contains ID3 tag/WMA tag information, the ID3 tag/WMA tag information is displayed (e.g., song name, artist name, and album name). All other tag data is ignored. If there is no text information, nothing will be displayed.

\*5 When the Text Scroll (refer to “Scroll Setting (Text Scroll) on page 98) is set to “Auto”, the display cannot be switched by pressing  View. The display contents switch alternately.

## About The Indication Display

When displaying Text, the following indicators are lit according to the mode.

Indicator/ Mode	HD Radio Mode	CD Mode	MP3/WMA/AAC Mode	iPod/iPhone/ BLUETOOTH Au- dio Mode
	—	—	Folder Name being displayed	—
	Artist Name being displayed	—	Artist Name being displayed	Artist Name being displayed
	—	—	Album Name being displayed	Album Name being displayed
	—	—	File Name being displayed	—
	—	Text (Disc Name) being displayed	—	—

Indicator/ Mode	HD Radio Mode	CD Mode	MP3/WMA/AAC Mode	iPod/iPhone/ BLUETOOTH Audio Mode
♪	Song Name being displayed	Text (Track Name) being displayed	Song Name being displayed	Song Name being displayed
(.●)	Station Name being displayed	—	—	—
PTY	PTY (Program Type) being displayed	—	—	—

### About “Text”

Text compatible CDs contain text information such as the disc name and track name. Such text information is referred to as “text”.

### NOTE:

- Some characters may not be displayed correctly with this device, depending on the character type.
- If there is no TEXT information, the display is blank.
- The text or tag information may not be correctly displayed, depending on the contents.





## Option Menu Setting

You can quickly adjust the setting items relevant to the current SOURCE by using Option Menu.

1. Press and hold  /ENTER/OPTION for at least 2 seconds to activate the Option menu of the current source.

### NOTE:

- The option menu varies depending on the source.
2. Turn the Rotary encoder to select the desired setting item, and then press  /ENTER.
  3. Turn the Rotary encoder to change the setting, and then press  /ENTER.

After the setting, the display will return to the current source automatically.

### • Setting item:

#### HD Radio mode:

Tuner Setup\*1 ↔ VOL LV ADJ\*2 ↔ MX Setup\*3 ↔ Tuner Setup

#### SiriusXM mode:

Alert Memory\*4 ↔ SiriusXM Setup\*5 ↔ VOL LV ADJ\*2 ↔ MX Setup\*3 ↔ Alert Memory

#### DISC mode:

CD Setup\*6 ↔ VOL LV ADJ\*2 ↔ MX Setup\*3 ↔ CD Setup

#### USB mode:

USB Setup\*7 ↔ VOL LV ADJ\*2 ↔ MX Setup\*3 ↔ USB Setup

**iPod mode:**

APP Direct\*8 ↔ iPod Setup\*9 ↔ VOL LV ADJ\*2 ↔ MX Setup\*3 ↔ APP Direct

**AUX mode:**

AUX Setup\*10 ↔ VOL LV ADJ\*2 ↔ MX Setup\*3 ↔ AUX Setup

**Pandora mode:**

VOL LV ADJ\*2 ↔ MX Setup\*3 ↔ VOL LV ADJ

**BT Audio mode:**

BT Setup\*11 ↔ VOL LV ADJ\*2 ↔ MX Setup\*3 ↔ BT Setup

**Phone mode (Non-calling mode):**

Phone Setup\*12 ↔ VOL LV ADJ\*13 ↔ Phone Setup

**Phone mode (Calling mode):**

MIC Gain\*14 ↔ Call Sound\*14 Speak Switch\*15 ↔ Voice Mute\*16 ↔ Call Wait\*17 ↔ END Call\*18 ↔ VOL LV ADJ\*13 ↔ MIC Gain

\*1 The setting items are the same as Tuner setting in SETUP mode. For details, refer to “SETUP” on page 88.

\*2 You can individually emphasize or weaken the volume level of the current source to create your own tonal preference. The setting values in Option mode and in SETUP mode are linkage. Refer to “Setting the Source Volume Level” on page 57.

\*3 Refer to “Setting the Media Xpander mode (MX Setup)” on page 58.

\*4 Refer to “Storing the desired Artist and Song Alerts” on page 176.

\*5 Alert Setup, Games Alert Setup, Parental Lock and Signal Indicator can be selected in this mode. For details about these settings, refer to "SiriusXM Setting" on page 169.

\*6 Play Mode can be selected in this mode. For details, refer to "Playing MP3/WMA/AAC Data (Play Mode)" on page 92.

\*7 USB Skip can be selected in this mode. For details, refer to "Setting the USB Skip function" on page 104.

\*8 Refer to "Setting the iPod Control" on page 149.

\*9 iPod List Setup can be selected in this mode. For details, refer to "iPod/iPhone Search Mode Setting" on page 105.

\*10 AUX Name can be selected in this mode. For details, refer to "Setting the AUX NAME mode" on page 92.

\*11 FW VERSION can be selected in this mode. You can see the current firmware version about BLUETOOTH by using this setting.

\*12 Call Sound, Caller ID, PB Update, PB Order, Auto Answer, Service Name, Speaker Select and FW Version can be selected in this mode. For details about these settings, refer to "BLUETOOTH SETUP" on page 113.

\*13 The Hands free phone talk level, ring tone level and microphone gain level can be adjusted by using this setting. Changing the settings in the Option mode will also affect the same settings in the SETUP menu. Refer to "Adjusting the volume (VOL LV ADJ)" on page 119.

\*14 Refer to "Setting the BLUETOOTH sound quality" on page 118.

\*15 While calling, the call sound can be switched between the unit and Smartphone by using this setting.

This operation can also be done by pressing BAND. Refer to “Call Switching Operation” on page 137.

\*16 While calling, and the Voice Mute is activated, the microphone input will mute instantly and “VOICE MUTE” will blink. This operation can also be done by pressing . Refer to “Muting the microphone input quickly (Voice Mute)” on page 137.

\*17 If there is a waiting call, select this item to display the caller’s Name and waiting number (1 or 2). Press  VIEW and the display will switch.

\*18 Select this item to hang up the call.

#### NOTE:

- Press  to return to the previous mode.
- If no operation is performed for 60 seconds, the unit will return to normal mode automatically.

## Applying TuneIt

This unit’s sound tuning is programmable from a connected Smartphone. It is also possible to download specific parameters for certain vehicles from Alpine’s TuneIt database stored in the Cloud. Using the TuneIt App, customized parameters can also be uploaded for others to share and rate.

Through this unit, it is also possible to receive and respond to information from Alpine’s Social Network Service (SNS) available through the connected Smartphone.

The installed TuneIt App should be launched on the Smartphone before connection to the head unit. TuneIt, is downloadable from Apple’s App Store; the Android user can download it from Google Play. For details, consult your Alpine dealer.

Before these operations, set Alpine APP to USB or BT depending on the connected Smartphone. For details, refer to “Setting the communication mode with a Smartphone (Alpine APP)” on page 106

**NOTE:**

- The application program and the related specifications and data may be deleted or terminated without notice.
- Some functions of TuneIt may not be available when the Smartphone is not in service area or receives no signal.

**Adjusting The Sound Via Smartphone**

After the above procedure, you can adjust the unit’s sound function on the Smartphone.

1. Make sure the unit is powered on.
2. Launch the TuneIt App on Smartphone. Adjust the unit’s sound accordingly on the Smartphone.

During sound setting,  /SOURCE key may blink.

**NOTE:**

- Volume and sound parameter preset function cannot be adjusted via Smartphone.
- The setting cannot be done on both the Smartphone and this unit at the same time. While the sound function of this unit is set via the Smartphone, sound function settings on CDE-HD149BT will be displayed as “APP Connect”.
- When the unit is powered off or during a call, sound setting cannot be done via the Smartphone.
- This function may not be available depending on the paired Smartphone.
- Please obey all local traffic laws while using this function.

## Facebook Notification Function

Some functions may be available in a future version of TuneIt.

### NOTE:

- Depending on the paired Smartphone, the following functions may not be available even though the TuneIt version is updated.

### Receiving Notification (Ready On Future Update)

When the Smartphone connected to this unit receives notification from Facebook, it will BEEP and the SOURCE key blinks (depending on the TuneIt settings on the phone). At the same time, the user's name is shown in the display (20 characters maximum).

1. While receiving Notification from Facebook, press  /SOURCE button.

Notification Menu screen is displayed.

2. Turn the Rotary encoder to select the desired mode, and then press  /ENTER .

Like\*1 ↔ Replay ↔ Next ↔ Previous ↔ TTS Volume\*2 ↔ Like

\*1 Not displayed only when the received Notification is Message type.

\*2 It can also be set in SETUP section. For details, refer to "Setting the TTS (Text To Speech) volume" on page 108.

### Like:

The Smartphone feedbacks to Facebook with "Like", and meanwhile, the received Wall Posts or Comments is played back by TTS (Text To Speech).

### Replay:

To play back Notification by TTS (Text To Speech) again.



- Next:** To select the next Notification.
- Previous:** To select the previous Notification.
- TTS Volume:** To adjust the playback volume of TTS (Text To Speech).

**NOTE:**

- Press  to return to the previous mode.
- A new received Notification prompt will last for 30 seconds. If there is no operation within 30 seconds, the unit will return to normal mode.
- When this unit is powered off or during a call, Notification of Smartphone will not be prompted by this unit.

**Displaying Notification List (Ready On Future Update)**

You can view the received Notification from Facebook in the connected Smartphone via this unit.

1. Press and hold  /SOURCE for at least 2 seconds.  
The received Notification will be displayed according to when it was posted.
2. Turn the Rotary encoder to select the desired Notification, and then press  /ENTER .
3. Then go to step 2 of “Receiving Notification”.

**NOTE:**

- When there is no Notification, “No Notification” will be displayed.
- The displayable amount of the Notification list depends on the connected Smartphone.

# SETUP

## CONTENTS

---

■ SETUP . . . . .	.88	□ Tuner Setting . . . . .	.99
□ Setting . . . . .	.88	□ iPod&USB Setting . . . . .	.104
□ General Setting . . . . .	.89	□ Application Setting (APP). . . . .	.106
□ Display Setting . . . . .	.95		



## SETUP

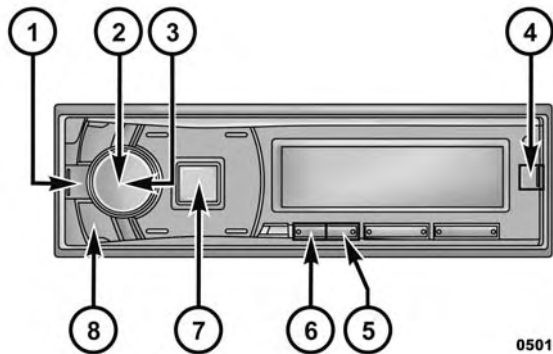

0501067436

1 — ←

2 — Rotary Encoder

3 — 🔍 /Enter

4 — 👁 View

5 — →

6 — ←

7 — 📺 Source

8 — AUDIO/SETUP

## Setting

You can flexibly customize the unit to suit your own preferences and usage. From the SETUP menu, General Setting, Display Setting, etc. can be modified.

Use steps 1 to 5 to select one of the SETUP modes to modify. See the applicable section below for details about the selected SETUP item.

1. Press and hold AUDIO/SETUP for at least 2 seconds to activate the SETUP mode.

2. Turn the Rotary encoder to select the desired item, and then press 🔍 /ENTER.

Audio\*1 ↔ General ↔ Display ↔ Tuner ↔  
 SiriusXM\*2 ↔ iPod&USB ↔ Application ↔  
 Bluetooth\*3 ↔ Audio

3. Turn the Rotary encoder to select a setting item, and then press 🔍 /ENTER.

**General:**

Clock Mode ↔ Clock Adjust\*4 ↔ Calendar ↔ AUX IN  
 ↔ AUX Name\*5 ↔ Play Mode ↔ Beep ↔ Demo ↔  
 Clock Mode

**Display:**

Illumination ↔ Dimmer ↔ Dimmer Level ↔ Scroll  
 Type ↔ Text Scroll ↔ Opening MSG ↔ Illumination

**Tuner:**

Multi Cast Seek ↔ Seek Type ↔ Listen Mode ↔ Live  
 Mode ↔ FM Tuner Setup ↔ Multi Cast Seek

**iPod&USB:**

USB Skip ↔ iPod List Setup ↔ USB Skip

**Application:**

Alpine APP ↔ TTS Volume ↔ Alpine APP

\*1 Refer to “Audio Setup”

\*2 Refer to “SiriusXM Setting”

\*3 Refer to “BLUETOOTH SETUP”

\*4 Refer to “Setting the Time and Calendar”

\*5 Displayed only when AUX IN is ON.

4. Turn the Rotary encoder to change the setting, and then press  /ENTER.
5. Press and hold AUDIO/SETUP for at least 2 seconds to return to normal mode.

**NOTE:**

- Pressing  returns to the previous SETUP mode.
- If no operation is performed for 60 seconds, SETUP is canceled.

**General Setting**

General is selected on the setup main menu in step 2.



### Setting The Clock Display (Clock Mode)

You can select the clock display type, 12-hour or 24-hour, depending on your preference.

- **Setting item:** Clock Mode

#### Setting contents:

00:00 (24-hour)/AM (Before noon) 12:00 (12-hour) (Initial setting)

1. Press and hold AUDIO/SETUP for at least 2 seconds to activate the SETUP mode.
2. Turn the Rotary encoder to select General, and press  /ENTER.
3. Turn the Rotary encoder to select Clock Mode, and press  /ENTER.

4. Turn the Rotary encoder to select either 00:00 (24-hour) or AM (Before noon) 12:00 (12-hour) (Initial setting), and press  /ENTER.
5. Press and hold AUDIO/SETUP for at least 2 seconds to return to normal mode.

### Setting of Calendar Display Pattern Switching (Calendar)

You can switch the calendar display pattern to be shown when the time is displayed.

- **Setting item:** Calendar

#### Setting contents:

mm/dd/yyyy (Initial setting) / dd/mm/yyyy / yyyy/mm/dd

**yyyy:**

Shows the year



**mm:**

Shows the month

**dd:**

Shows the day

ex. dd/mm/yyyy → 01/01/2013

1. Press and hold AUDIO/SETUP for at least 2 seconds to activate the SETUP mode.
2. Turn the Rotary encoder to select General, and press  /ENTER.
3. Turn the Rotary encoder to select Calendar, and press  /ENTER.
4. Turn the Rotary encoder to select either mm/dd/yyyy (Initial setting), dd/mm/yyyy or yyyy/mm/dd, and press  /ENTER.

**Setting The AUX SETUP mode**

You can input the audio of an external device, (such as a Portable audio player) to the AUX connector of this unit.

- **Setting item:** AUX IN

**Setting contents:**

OFF / ON (Initial setting)







**OFF:**

When set to OFF, AUX source cannot be selected.

**ON:**

Set to ON, when the portable device is connected. If  /SOURCE is pressed and AUX is selected, the sound of the portable device is input to the unit.

1. Press and hold AUDIO/SETUP for at least two 2 seconds to activate the SETUP mode.

2. Turn the Rotary encoder to select General, and press  /ENTER.
  3. Turn the Rotary encoder to select AUX IN, and press  /ENTER.
  4. Turn the Rotary encoder to select either OFF or ON (Initial setting), and press  /ENTER.
  5. Press and hold AUDIO/SETUP for at least two 2 seconds to return to normal mode.
1. Press and hold AUDIO/SETUP for at least 2 seconds to activate the SETUP mode.
  2. Turn the Rotary encoder to select General, and press  /ENTER.
  3. Turn the Rotary encoder to select AUX Name Mode, and press  /ENTER.
  4. Turn the Rotary encoder to select either Auxiliary (Initial setting), TV, DVD, Portable or Game, and press  /ENTER.
  5. Press and hold AUDIO/SETUP for at least 2 seconds to return to normal mode.

### Setting The AUX NAME Mode

You can change the AUX NAME display in the SETUP mode.

- **Setting item:** AUX Name

#### Setting contents:

Auxiliary (Initial setting) / TV / DVD / Portable / Game

### Playing MP3/WMA/AAC Data (Play Mode)

This unit can play back CDs containing both CD and MP3/WMA/AAC data (created in Enhanced CD (CD Extra) format). However, in some situations, playback of an enhanced CD may be difficult. In this case, you can

select playback of a single session only, containing the CD data. When a disc contains both CD and MP3/WMA/AAC data, playback starts from the CD data portion of the disc.

- **Setting item:** Play Mode

**Setting contents:**

CD-DA / CDDA&MP3/WMA (Initial setting)

**CD-DA:**



Only the CD data in Session 1 can be played back.

**CDDA&MP3/WMA:**

CD data, MP3/WMA/AAC files in mixed mode, and multi-session discs can be played back.

**NOTE:**

- Perform this setting before inserting a disc. If a disc has already been inserted, remove it first.

1. Press and hold AUDIO/SETUP for at least 2 seconds to activate the SETUP mode.
2. Turn the Rotary encoder to select General, and press  /ENTER.
3. Turn the Rotary encoder to select Play Mode, and press  /ENTER.
4. Turn the Rotary encoder to select either CD-DA or CDDA&MP3/WMA (Initial setting), and press  /ENTER.
5. Press and hold AUDIO/SETUP for at least 2 seconds to return to normal mode.

**Sound (Beep) Guide Function**



This function will give audible feedback with varying tones depending upon the button pressed.

- **Setting item:** Beep

**Setting contents:**

OFF / Level 1~7

**NOTE:**

- The initial setting is Level 4.
1. Press and hold AUDIO/SETUP for at least two 2 seconds to activate the SETUP mode.
  2. Turn the Rotary encoder to select General, and press  /ENTER.
  3. Turn the Rotary encoder to select Beep, and press  /ENTER.
  4. Turn the Rotary encoder to select either OFF or Level 1~7, and press  /ENTER.
  5. Press and hold AUDIO/SETUP for at least two 2 seconds to return to normal mode.

**Demonstration**



This unit has a demonstration feature for the display.

- **Setting item:** Demo

**Setting contents:**

OFF (Initial setting) / ON

**NOTE:**

- To exit Demo mode, set to Demo OFF.
1. Press and hold AUDIO/SETUP for at least 2 seconds to activate the SETUP mode.
  2. Turn the Rotary encoder to select General, and press  /ENTER.
  3. Turn the Rotary encoder to select Demo, and press  /ENTER.

4. Turn the Rotary encoder to select either OFF (Initial setting) or ON, and press  /ENTER.
5. Press and hold AUDIO/SETUP for at least 2 seconds to return to normal mode.

### Display Setting

Display is selected on the setup main menu in step 2.

### Changing Lighting Color

You can change the lighting color of the unit's buttons.

- **Setting item:** Illumination

#### Setting contents:

TYPE1 / TYPE2 / TYPE3 / TYPE4 (Initial setting)

#### TYPE1:

The color of all buttons is blue.

#### TYPE2:



The color of all buttons is green.

#### TYPE3:

The color of all buttons is amber.

#### TYPE4:

The color of all buttons is red.

1. Press and hold AUDIO/SETUP for at least 2 seconds to activate the SETUP mode.
2. Turn the Rotary encoder to select Display, and press  /ENTER.
3. Turn the Rotary encoder to select Illumination, and press  /ENTER.
4. Turn the Rotary encoder to select either TYPE1, TYPE2, TYPE3 or TYPE4 (Initial setting), and press  /ENTER.



5. Press and hold AUDIO/SETUP for at least 2 seconds to return to normal mode.

### Dimmer Control



Set the Dimmer control to Auto to decrease the illumination brightness of the unit with the head lights of the vehicle ON. This mode is useful if you feel the unit's backlighting is too bright at night.

- **Setting item:** Dimmer

#### Setting contents:

Manual / Auto (Initial setting)

1. Press and hold AUDIO/SETUP for at least 2 seconds to activate the SETUP mode.
2. Turn the Rotary encoder to select Display, and press  /ENTER.

3. Turn the Rotary encoder to select Dimmer, and press  /ENTER.
4. Turn the Rotary encoder to select either Manual or Auto (Initial setting), and press  /ENTER.
5. Press and hold AUDIO/SETUP for at least 2 seconds to return to normal mode.

### Dimmer Level Setting



In the Dimmer Level setting, three levels are available, the highest level (Level 3) being the dimmest when the car headlights are on.

- **Setting item:** Dimmer Level

#### Setting contents:

Level 1 (Initial setting) / Level 2 / Level 3

1. Press and hold AUDIO/SETUP for at least 2 seconds to activate the SETUP mode.

2. Turn the Rotary encoder to select Display, and press  /ENTER.
3. Turn the Rotary encoder to select Dimmer Level, and press  /ENTER.
4. Turn the Rotary encoder to select either Level 1 (Initial setting), Level 2 or Level 3, and press  /ENTER.
5. Press and hold AUDIO/SETUP for at least 2 seconds to return to normal mode.

### Scroll Type Setting

Choose the type you prefer from two scrolling methods.

- **Setting item:** Scroll Type

#### Setting contents:



TYPE 1 (Initial setting) / TYPE 2

#### TYPE 1:

The characters scroll from right to left, one character at a time, until the entire title has scrolled.

#### TYPE 2:

Words are built up from left to right, a single character at a time. When the display is full, it is cleared and the subsequent words are displayed the same way until all words of the title have been shown.

1. Press and hold AUDIO/SETUP for at least 2 seconds to activate the SETUP mode.
2. Turn the Rotary encoder to select Display, and press  /ENTER.
3. Turn the Rotary encoder to select Scroll Type, and press  /ENTER.
4. Turn the Rotary encoder to select either TYPE 1 (Initial setting) or TYPE 2, and press  /ENTER.

5. Press and hold AUDIO/SETUP for at least 2 seconds to return to normal mode.

### Scroll Setting (Text Scroll)

This CD player can scroll the disc and track names recorded on CD-TEXT discs, as well as text information of MP3/WMA/AAC files, folder names, tags, HD Radio broadcasts and SiriusXM.

- **Setting item:** Text Scroll

#### Setting contents:



Manual (Initial setting) / Auto

#### Manual:

The above information is scrolled only when a disc is loaded, a channel or track is changed, etc.

#### Auto:

CD text information, folder and file names, HD Radio and SiriusXM text are scrolled continuously. In addition, all tag information is automatically rotated in the display continuously, without pressing the  VIEW button. (Except SiriusXM)

1. Press and hold AUDIO/SETUP for at least 2 seconds to activate the SETUP mode.
2. Turn the Rotary encoder to select Display, and press  /ENTER.
3. Turn the Rotary encoder to select Text Scroll, and press  /ENTER.
4. Turn the Rotary encoder to select either Manual (Initial setting) or Auto, and press  /ENTER.
5. Press and hold AUDIO/SETUP for at least 2 seconds to return to normal mode.

**NOTE:**

- In parts of the display, scrolling may not occur, or scroll content may differ.

**Opening Message ON/OFF Setting**



This unit includes a special message feature with various patterns, which when enabled displays opening messages for certain occasions. For example, when you turn this unit on December 25th (according to the unit's date setting), a Christmas greeting is displayed if the Opening Message is set to ON.

- **Setting item:** Opening MSG

**Setting contents:**

OFF (Initial setting) / ON

1. Press and hold AUDIO/SETUP for at least 2 seconds to activate the SETUP mode.

2. Turn the Rotary encoder to select Display, and press  /ENTER.
3. Turn the Rotary encoder to select Opening MSG, and press  /ENTER.
4. Turn the Rotary encoder to select either OFF (Initial setting) or ON, and press  /ENTER.
5. Press and hold AUDIO/SETUP for at least 2 seconds to return to normal mode.

**Tuner Setting**

Tuner is selected on the setup main menu in step 2.



**Setting The Multicast Seek**

Multicast Seek can be set to ON/OFF.

- **Setting item:** Multi Cast Seek

**Setting contents:**

OFF / ON (Initial setting)

1. Press and hold AUDIO/SETUP for at least 2 seconds to activate the SETUP mode.
2. Turn the Rotary encoder to select Tuner Setting, and press  /ENTER.
3. Turn the Rotary encoder to select Setting the Multicast Seek, and press  /ENTER.
4. Turn the Rotary encoder to select either OFF or ON (Initial setting), and press  /ENTER.

**OFF:**

SEEK is available only for the Main Program Service. Multicast stations are ignored.

**ON:**

SEEK finds both the Main Program Service and Sub-program Service of Multicast stations.

5. Press and hold AUDIO/SETUP for at least 2 seconds to return to normal mode.

**Setting The Digital Seek**

Digital Seek can be set to ON/OFF.

- **Setting item:** Seek Type

**Setting contents:**

Hybrid (Initial setting) / Digital



**Hybrid:**

SEEK UP/DOWN is available for digital and analog radio stations. However, the strong signals have priority during SEEK.

**Digital:**

SEEK UP/DOWN is available only for the digital radio station. Any analog only stations (or very weak digital) are skipped.

1. Press and hold AUDIO/SETUP for at least 2 seconds to activate the SETUP mode.

2. Turn the Rotary encoder to select Tuner Setting, and press  /ENTER.
3. Turn the Rotary encoder to select Seek Type, and press  /ENTER.
4. Turn the Rotary encoder to select either Hybrid (Initial setting) or Digital, and press  /ENTER.
5. Press and hold AUDIO/SETUP for at least 2 seconds to return to normal mode.

### Switching The Listening Mode

The unit provides you four (4) reception methods, among which you can select an optimized method to receive the Digital signal or Analog signal according to your own preference and the signal strength.

- **Setting item:** Listen Mode

### Setting contents:

Hybrid / Digital / Digital MC (Initial setting) / Analog

### Hybrid:

Receive both digital and analog radio stations. If the digital signal is weak, this unit will switch to receive the analog radio signal automatically.

### Digital:



Keep receiving the digital radio signal, even when the digital signal is weak.

### Digital MC:

Keep receiving the digital radio signal while listen to a Sub-program Service of a Multicast station.

**Analog:**

Only receive the analog radio signal, even when the digital signal is strong.

1. Press and hold AUDIO/SETUP for at least 2 seconds to activate the SETUP mode.
2. Turn the Rotary encoder to select Tuner Setting, and press  /ENTER.
3. Turn the Rotary encoder to select Listen Mode, and press  /ENTER.
4. Turn the Rotary encoder to select either Hybrid, Digital, Digital MC (Initial setting) or Analog and press  /ENTER.
5. Press and hold AUDIO/SETUP for at least 2 seconds to return to normal mode.

**Setting The Live Mode (Live Mode)**

While receiving a live broadcast, you can select an optimized receiving method according to your own preference and the signal strength.

- **Setting item:** Live Mode

**Setting contents:**

Analog (Initial setting) / Digital / Listen Mode

**Analog:**



While receiving a live broadcast, this unit will only receive the analog radio signal even when the digital signal can be received.

**Digital:**

While receiving a live broadcast, this unit will keep receiving the digital radio signal even when the digital signal is weak.

**Listen Mode:**

While receiving a live broadcast, the setting value is the same as that in Listen Mode, refer to “Switching the listening mode” on page 101.

1. Press and hold AUDIO/SETUP for at least 2 seconds to activate the SETUP mode.
2. Turn the Rotary encoder to select Tuner Setting, and press  /ENTER.
3. Turn the Rotary encoder to select Live Mode, and press  /ENTER.
4. Turn the Rotary encoder to select either Analog (Initial setting), Digital or Listen Mode, and press  /ENTER.
5. Press and hold AUDIO/SETUP for at least 2 seconds to return to normal mode.

**Setting The TUNER (FM) Tone Quality**

This unit can set your preferred tone quality for FM radio source.

- **Setting item:** FM Tuner Setup

**Setting contents:**

Hi-Fi / Normal (Initial setting) / Stable

**Hi-Fi:**

High-quality setting

**Normal:**



Standard setting

**Stable:**

Control noise

1. Press and hold AUDIO/SETUP for at least 2 seconds to activate the SETUP mode.



2. Turn the Rotary encoder to select Tuner Setting, and press  /ENTER.
3. Turn the Rotary encoder to select FM Tuner Setup, and press  /ENTER.
4. Turn the Rotary encoder to select either Hi-Fi, Normal (Initial setting) or Stable, and press  /ENTER.
5. Press and hold AUDIO/SETUP for at least 2 seconds to return to normal mode.

**NOTE:**

- Noise may be more noticeable when Hi-Fi is set, depending on the reception status. In this case, the Normal setting is recommended.

**iPod&USB Setting**

iPod&USB is selected on the setup main menu in step 2.

**Setting The USB Skip Function**



During searching, you can skip over designated folders/files by pressing and holding Rewind ◀ / ▶ Forward for at least 2 seconds. For example, if you select 10File in the searching mode, by pressing and holding Rewind ◀ you can skip backward 10 folders/files from the current folder/file; by pressing and holding ▶ Forward you can skip forward 10 folders/files from the current folder/file. If the folders/files searched are less than the assigned skipped-over ones, pressing and holding Rewind ◀ / ▶ Forward will skip to the first or last folder/file.

- **Setting item:** USB Skip

**Setting contents:**

10File (Initial setting) / 20File / 50File / 100File

1. Press and hold AUDIO/SETUP for at least 2 seconds to activate the SETUP mode.

2. Turn the Rotary encoder to select iPod&USB, and press  /ENTER.
3. Turn the Rotary encoder to select USB Skip, and press  /ENTER.
4. Turn the Rotary encoder to select either 10File (Initial setting), 20File, 50File or 100File, and press  /ENTER.
5. Press and hold AUDIO/SETUP for at least 2 seconds to return to normal mode.



### iPod/iPhone Search Mode Setting

The unit allows you to search for the iPod/iPhone using nine different search modes.

- **Setting item:** iPod List Setup
- **Further setting items:** Playlists / Artists / Albums / Audiobooks / Podcasts / Genres / Composers / Songs / Genius Mixes

### Setting contents:

OFF / ON

1. Press and hold AUDIO/SETUP for at least 2 seconds to activate the SETUP mode.
2. Turn the Rotary encoder to select iPod&USB, and press  /ENTER.
3. Turn the Rotary encoder to select iPod List Setup, and press  /ENTER.
4. Turn the Rotary encoder to select either Playlists, Artists, Artists, Albums, Audiobooks, Podcasts, Genres, Composers, Songs, or Genius Mixes, and press  /ENTER.
5. Turn the Rotary encoder to select either OFF or ON.
6. Press and hold AUDIO/SETUP for at least 2 seconds to return to normal mode.

**NOTE:**

- When the search mode is in Playlists/Artists/Albums/Podcasts/Genres/ Songs/Genius Mixes, the initial setting is On, and when the search mode is in Audiobooks/Composers, the initial setting is Off.
- For search mode details, refer to “Searching for a desired song” on page 139.

**Application Setting (APP)**

Application is selected on the setup main menu in step 2.

**Setting The Communication Mode With A Smartphone (Alpine APP)**

Set Alpine APP to USB when an iPhone is connected, or set to BT when an Android Smartphone is paired.

- **Setting item:** Alpine APP

**Setting contents:**

OFF / USB (Initial setting) / BT

**OFF:**



No Smartphone is connected.

**USB:**

When an iPhone is connected to CDE-HD149BT's USB port, you can enjoy Pandora program the unit's sound tuning parameters, or communicate with SNS.

**BT:**

Set this when an Android Smartphone is paired with this unit via BLUETOOTH technology. At this time, you can enjoy Pandora, program the unit's sound tuning parameters, or communicate with SNS.

1. Press and hold AUDIO/SETUP for at least 2 seconds to activate the SETUP mode.
2. Turn the Rotary encoder to select Application, and press  /ENTER.
3. Turn the Rotary encoder to select Alpine APP, and press  /ENTER.
4. Turn the Rotary encoder to select either OFF, USB (Initial setting) or BT, and press  /ENTER.
5. Press and hold AUDIO/SETUP for at least 2 seconds to return to normal mode.

**NOTE:**

- After the above setting, turn the ignition key off (ACC OFF) and on again (ACC ON).
- For this function to work properly, specific applications must be installed on your Smartphone before connection. Consult your Alpine dealer or the Alpine web site for details.
- Only the iPhone and certain Android Smartphones support this function.

## Setting The TTS (Text To Speech) Volume



This function allows for readout of comments, etc., on a Smartphone, and outputs sound from the speaker of the unit.

- **Setting item:** TTS Volume

### Setting contents:

0~35

1. Press and hold AUDIO/SETUP for at least 2 seconds to activate the SETUP mode.
2. Turn the Rotary encoder to select Application, and press  /ENTER.

3. Turn the Rotary encoder to select TTS Volume, and press  /ENTER.
4. Turn the Rotary encoder to select 0~35, and press  /ENTER.
5. Press and hold AUDIO/SETUP for at least 2 seconds to return to normal mode.

### NOTE:

- The initial volume level is 12.

# BLUETOOTH HANDS FREE CALLING

## CONTENTS

---

■ BLUETOOTH HANDS FREE CALLING . . . . .	.110	□ Hands-Free Phone Control . . . . .	.127
□ Setup Before Using. . . . .	.111	□ Bluetooth Audio Operation. . . . .	.138
□ BLUETOOTH Setup . . . . .	.113		

## BLUETOOTH HANDS FREE CALLING

### NOTE:

- Always drive safely with your hands on the steering wheel and obey all applicable laws. You have full responsibility and assume all risks related to the use of the features and applications in this vehicle. Only use the features and applications in this vehicle when it is safe to do so. Failure to do so may result in an accident involving in serious injury or death.
- Any voice commanded system should be used only in safe driving conditions following all applicable laws. Your attention should be focused on safely operating the vehicle. Failure to do so may result in a collision causing serious injury or death.

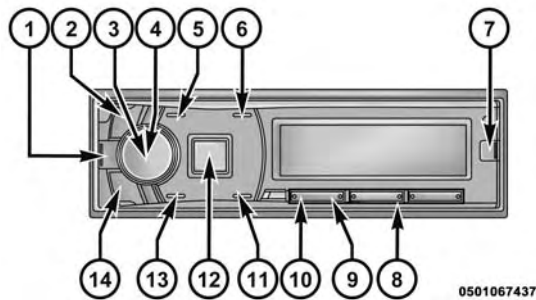

- |                                     |                      |
|-------------------------------------|----------------------|
| 1 —  ON/OFF/Return                  | 9 —  Forward         |
| 2 —  /VOICE CONTROL                 | 10 —  Rewind         |
| 3 — Rotary Encoder                  | 11 — BAND/ABC SEARCH |
| 4 —  /Enter                         | 12 —  Source         |
| 5 —  Fast Rewind                    | 13 —  Play/Pause     |
| 6 —  Fast Forward                   | 14 — AUDIO/SETUP     |
| 7 —  View                           |                      |
| 8 — Preset Buttons<br>(1 through 6) |                      |

## Setup Before Using

### About BLUETOOTH

BLUETOOTH is a wireless technology allowing communication between a mobile device or personal computer over short distances. This enables a hands-free call or data transmission between BLUETOOTH compatible devices. BLUETOOTH transmission is available in the unlicensed 2.4 GHz spectrum if the distance between devices is within 10 meters. For details, refer to the BLUETOOTH Home page (<http://www.bluetooth.com>).

#### NOTE:

- Depending on the BLUETOOTH version, a BLUETOOTH compatible device may not be able to communicate with this unit.
- Proper function of this unit with all BLUETOOTH compatible devices is not guaranteed. For handling of the BT compatible device, consult your ALPINE dealer or ALPINE website.
- Depending on the surroundings, BLUETOOTH wireless connection may be unstable.
- When you place a call, or perform setup operations, be sure to stop your car in a safe place.
- Depending on the connected BLUETOOTH compatible device(s), the function may differ. Also refer to the Owner's Manual of the connected device(s).
- When you search for this unit using the BLUETOOTH compatible phone, the unit name is displayed as "Alpine CD Receiver".



### Before Using BLUETOOTH Function

Before using the BLUETOOTH function, the following settings need to be made.

Set "Bluetooth IN" to ON when you want to use Hands-Free phone or Bluetooth Audio function. Refer to "Setting the BLUETOOTH Connection (Bluetooth IN)" on page 114.

#### NOTE:

- Before using BLUETOOTH function, it must be paired with this unit. Refer to "How to connect to a BLUETOOTH compatible device (Pairing)" on page 112.

### How To Connect To A Bluetooth Compatible Device (Pairing)

For details on the control from a BLUETOOTH compatible device, refer to the Owner's Manual of the BLUETOOTH compatible device.

### Pairing a BLUETOOTH compatible device with SSP (Secure Simple Pairing)

1. Using your BLUETOOTH compatible device, select the "Alpine CD Receiver" for pairing.
2. Turn the Rotary encoder to change the head unit display from "Pairing NO" to "Pairing YES", and then press  /ENTER.  
If "Pairing NO" is selected, the connection will be canceled.
3. If the pairing was successful, "Connected" is displayed for a few seconds. The head unit then returns to its previous state.

### Pairing a BLUETOOTH compatible device without SSP (Secure Simple Pairing)

1. Using your BLUETOOTH compatible device, select the "Alpine CD Receiver" for pairing.

2. Input the passcode (“0000”) in a BLUETOOTH compatible device.

**NOTE:**

- The passcode is fixed as “0000”.

3. If the pairing was successful, “Connected” is displayed for a few seconds. The head unit then returns to its previous state.

**NOTE:**

- If the connection is unsuccessful, “Failed” is displayed.
- After a successful pairing, the two devices should reconnect automatically whenever the vehicle’s ignition is turned ON. If the auto connection fails, try to reconnect manually.
- Set “Visible Mode” to ON to enable this unit to be recognized by a BLUETOOTH compatible device, refer to “Setting the Visible Mode” on page 117.

- You can also manually pair the BLUETOOTH devices from this unit. For details, refer to “Pairing a BLUETOOTH Device from the unit” on page 117.

**BLUETOOTH Setup**

The following steps 1 to 5 are common to the various BLUETOOTH functions. For details, refer to each individual function.

**NOTE:**

- Set “Bluetooth IN” to ON, and then perform BLUETOOTH SETUP operation. Refer to “Setting the BLUETOOTH Connection (Bluetooth IN)” on page 114.
1. Press and hold AUDIO/SETUP for at least 2 seconds to activate the SETUP mode.
  2. Turn the Rotary encoder to select “Bluetooth”, and then press  /ENTER.

The BLUETOOTH setup mode is activated.

3. Turn the Rotary encoder to select the desired items and then press  /ENTER.

#### BLUETOOTH:

Bluetooth IN\*1 ↔ Paired Device\*2 ↔ Visible Mode\*1/\*2 ↔ Search Device\*1/\*2 ↔ Call Sound\*2 ↔ Caller ID\*2 ↔ PB Update\*1/\*2 ↔ PB Order\*2 ↔ Auto Answer\*2 ↔ Service Name\*2 ↔ Speaker Select\*2 ↔ FW Version\*2 ↔ FW Update\*1/\*2 ↔ Bluetooth IN

\*1 The items are not displayed during a phone call.

\*2 The items are not displayed if “Bluetooth IN” is set to OFF. Refer to “Setting the BLUETOOTH Connection (Bluetooth IN)” on page 114.

4. Turn the Rotary encoder to change the settings.
5. Press and hold AUDIO/SETUP for at least 2 seconds.  
The SETUP mode is canceled.

#### NOTE:

- Press  to return to the previous mode.
- If no operation is performed for 60 seconds, the unit will return to normal mode automatically.

#### Setting The BLUETOOTH Connection (Bluetooth IN)

With BLUETOOTH technology, you can place a hands-free call by a BLUETOOTH-equipped Smartphone.

Audio information of a BLUETOOTH compatible Smartphone, a portable audio player, etc., is controllable/playable wirelessly from this unit.

- **Setting item:** Bluetooth IN

#### Setting contents:



OFF / ON (Initial setting)

**OFF:**

Hands-Free Phone function and Bluetooth Audio function are not used.



**ON:**

Select when you want to pair your BLUETOOTH compatible phone with this unit or use Bluetooth Audio function.

1. Press and hold AUDIO/SETUP for at least 2 seconds to activate the SETUP mode.
2. Turn the Rotary encoder to select "Bluetooth", and then press  /ENTER.
3. Turn the Rotary encoder to select Bluetooth IN and then press  /ENTER.
4. Turn the Rotary encoder to select either OFF or ON (Initial setting) and press  /ENTER.

5. Press and hold AUDIO/SETUP for at least 2 seconds to return to normal mode.

**NOTE:**



- When Bluetooth IN is set to OFF, the indicators related to Hands-free phone (  battery quantity and  signal strength) will not be displayed.

**Setting The BLUETOOTH Device**

Select one of 3 connected BLUETOOTH compatible devices that you previously registered.

- **Setting item:** Paired Device

1. Press and hold AUDIO/SETUP for at least 2 seconds to activate the SETUP mode.
2. Turn the Rotary encoder to select "Bluetooth", and then press  /ENTER.









3. Turn the Rotary encoder to select Paired Device and then press  /ENTER.
4. Turn the Rotary encoder to select a BLUETOOTH compatible device you want to use (you want to change connection) and then press  /ENTER.
5. Turn the Rotary encoder to select "Connect" to connect the selected device.

The connected device is marked with . Select "Disconnect" to disconnect this device. Select "Clear" when you want to clear the device from the device list.

6. Press and hold AUDIO/SETUP for at least 2 seconds to return to normal mode.

#### NOTE:

- If the connection is successfully changed, "Connected" is displayed for 2 seconds and the  indicator lights up, then the display returns to the SETUP screen.

- If a Smartphone is connected to this unit successfully, the  indicator lights up to show the battery charge of the connected Smartphone. The  indicator lights up when the battery charge is about 50%, the  indicator lights up when the battery charge is not enough, and it blinks as a low level warning. The  indicator goes out when the battery is drained. At this time, the BLUETOOTH function is unavailable due to the Smartphone powered off.
- Indicator  (Signal Strength) will display the current signal strength of your service provider. The  indicator goes out when the Smartphone is not in service area or receives no signal.
- Depending on the connected Smartphone, the  (battery charge), and  (signal strength) indicators may not be displayed.

- If all the 3 positions have been registered, you cannot register the 4th device. To register another device, you need to delete one of the devices from position 1 to 3 first.

### Setting The Visible Mode

You can set whether this unit can be recognized or not from a BLUETOOTH compatible device. Normally set this to ON.



- **Setting item:** Visible Mode

#### OFF:

Disable recognition of this unit from the BLUETOOTH compatible device.



#### ON:

Enable recognition of this unit from the BLUETOOTH compatible device.



1. Press and hold AUDIO/SETUP for at least 2 seconds to activate the SETUP mode.
2. Turn the Rotary encoder to select "Bluetooth", and then press  /ENTER.
3. Turn the Rotary encoder to select Visible Mode and then press  /ENTER.
4. Turn the Rotary encoder to select either OFF or ON (Initial setting) and press  /ENTER.
5. Press and hold AUDIO/SETUP for at least 2 seconds to return to normal mode.

### Pairing A Bluetooth Device From The Unit

If your BLUETOOTH device is not immediately pairing, the head unit can perform a search. The search can find paired or unpaired devices.

- **Setting item:** Search Device
1. Press and hold AUDIO/SETUP for at least 2 seconds to activate the SETUP mode.
  2. Turn the Rotary encoder to select “Bluetooth”, and then press  /ENTER.
  3. Turn the Rotary encoder to select Search Device and then press  /ENTER.
  4. When Search Device is selected and “Searching” is displayed, the search gets started.

**NOTE:**

- The “Searching” operation can be stopped by pressing .
5. Turn the Rotary encoder to select the name of the device to be connected from the Device Search list and press  /ENTER.

6. If this unit is successfully connected to a BLUETOOTH compatible device, “Connected” is displayed, and then the unit returns to normal mode.



Depending on the Smartphone, it may be necessary to input a passcode. In this case, “Pass code 0000” is displayed. Input the pass code “0000” in the BLUETOOTH compatible device to make the pairing. After the pairing is completed, the unit will automatically connect to the BLUETOOTH compatible device. If you input the wrong pass code or the communication fails, “Failed” is displayed.

**Setting The Bluetooth Sound Quality**

You can flexibly customize the sound of a call to fit your own preferences.

- **Setting item:** Call Sound

- **Further setting items:** VOL LV ADJ / Type Setup

1. Press and hold AUDIO/SETUP for at least 2 seconds to activate the SETUP mode.
2. Turn the Rotary encoder to select “Bluetooth”, and then press  /ENTER.
3. Turn the Rotary encoder to select Call Sound and then press  /ENTER.
4. Turn the Rotary encoder to select either VOL LV ADJ or Type Setup and press  /ENTER.
5. Press and hold AUDIO/SETUP for at least 2 seconds to return to normal mode.

### Adjusting The Volume (VOL LV ADJ)

You can emphasize or weaken the volume level of the Phone call, the ring tone and the microphone input to fit your own preferences.

- **Setting contents:**

#### Phone Talk:

-5 dB ~ +5 dB

#### Ring Tone:

-5 dB ~ +5 dB

#### MIC Gain:

-5 dB ~ +5 dB

### Sound Type Setting (Type Setup)

Depending on your calling environment, choose one of the settings below which gives the best sound quality.

**Setting contents:** TYPE1 (Initial setting) / TYPE2 / TYPE3 / TYPE4 / TYPE5

#### TYPE1:

Standard Mode (recommended)



**TYPE2:**

Enhances the noise reduction

**TYPE3:**

Enhances the echo-cancel

**TYPE4:**

Enhances both noise reduction and echo-cancel

**TYPE5:**

Weakens both noise reduction and echo-cancel

**NOTE:**

- The functions below are designed to improve the sound quality of the outgoing call.

Noise reduction: This function can reduce the road noise, but excessive enhancement may affect the sound quality of the call.

Echo-cancel: This function can reduce the echo, but excessive enhancement may affect the sound quality of the call.



**Setting the Caller Information Display/ Text Message Indicator ON/OFF**

You can choose whether to use these functions according to the following setting.

- **Setting item:** Caller ID

**Setting contents:**

OFF / ON (Initial setting)

1. Press and hold AUDIO/SETUP for at least 2 seconds to activate the SETUP mode.
2. Turn the Rotary encoder to select "Bluetooth", and then press  /ENTER.
3. Turn the Rotary encoder to select Caller ID and then press  /ENTER.
4. Turn the Rotary encoder to select either OFF or ON (Initial setting) and press  /ENTER.

5. Press and hold AUDIO/SETUP for at least 2 seconds to return to normal mode.

If you want to keep the ID information of the caller from others, set this item to OFF. Depending on the stored ID information, while you are dialing a number or a call is dialing in, only telephone number will be displayed or telephone name will be displayed as “NO Name”; During a call, “NO Name” will be displayed.

### Setting The Phone Book Update

You can update the phone book automatically or manually.

- **Setting item:** PB Update

**Setting contents:**

Auto / Manual

1. Press and hold AUDIO/SETUP for at least 2 seconds to activate the SETUP mode.

2. Turn the Rotary encoder to select “Bluetooth”, and then press  /ENTER.

3. Turn the Rotary encoder to select PB Update and then press  /ENTER.

4. Turn the Rotary encoder to select either Auto or Manual and press  /ENTER.

5. Press and hold AUDIO/SETUP for at least 2 seconds to return to normal mode.





### Setting The Phone Book Auto Update ON/OFF (Auto)

When you select ON in this step, whenever the vehicle’s ignition is turned ON or after the phone is reconnected with this unit, the phone book will be updated automatically.

- **Setting contents:**

OFF / ON (Initial setting)

**NOTE:**



- Updating” will be displayed during the phone book update.
1. Press and hold AUDIO/SETUP for at least 2 seconds to activate the SETUP mode.
  2. Turn the Rotary encoder to select “Bluetooth”, and then press  /ENTER.
  3. Turn the Rotary encoder to select PB Update and then press  /ENTER.
  4. Turn the Rotary encoder to select Auto and press  /ENTER.
  5. Turn the Rotary encoder to select either OFF or ON (Initial setting) and press  /ENTER.
  6. Press and hold AUDIO/SETUP for at least 2 seconds to return to normal mode.

**Setting The Phone Book Manual Update ON/OFF (Manual)**

When you select YES in this step, the phone book will be updated immediately regardless if the Auto update function is on or off.

- **Setting contents:**

NO (Initial setting) / YES

1. Press and hold AUDIO/SETUP for at least 2 seconds to activate the SETUP mode.
2. Turn the Rotary encoder to select “Bluetooth”, and then press  /ENTER.
3. Turn the Rotary encoder to select PB Update and then press  /ENTER.
4. Turn the Rotary encoder to select Manual and press  /ENTER.

5. Turn the Rotary encoder to select either NO (Initial setting) or YES and press  /ENTER.
6. Press and hold AUDIO/SETUP for at least 2 seconds to return to normal mode.

**NOTE:**

- “Updating” will be displayed during the phone book update.

**Changing The Phone Book List Order**



The phone book is listed alphabetically by the first letter of First or Last Name.

Listing by First Name is the default but Last Name can be selected.

- **Setting item:** PB Order

**Setting contents:**

First Name (Initial setting) / Last Name

1. Press and hold AUDIO/SETUP for at least 2 seconds to activate the SETUP mode.
2. Turn the Rotary encoder to select “Bluetooth”, and then press  /ENTER.
3. Turn the Rotary encoder to select PB Order and then press  /ENTER.
4. Turn the Rotary encoder to select either First Name (Initial setting) or Last Name and press  /ENTER.
5. Press and hold AUDIO/SETUP for at least 2 seconds to return to normal mode.

**NOTE:**

- “Waiting” will be displayed while the Phone book order is switching. You can cancel the “Waiting” screen to perform other operations by pressing  when the ordering is still in progress. The phone book is not accessible during this time. In addition, the ordering may affect the playback of Bluetooth Audio.

**Setting The Received Calls Automatically (Auto Answer)**



When a call is received, you can set whether to receive it automatically or not.

- **Setting item:** Auto Answer

**Setting contents:**



OFF (Initial setting) / ON

**OFF:**

When a call is received, it is not answered automatically. Press  or  /ENTER to receive the call.

**ON:**

When a call is received, it is answered automatically after about 5 seconds.

1. Press and hold AUDIO/SETUP for at least 2 seconds to activate the SETUP mode.
2. Turn the Rotary encoder to select “Bluetooth”, and then press  /ENTER.
3. Turn the Rotary encoder to select Auto Answer and then press  /ENTER.
4. Turn the Rotary encoder to select either OFF (Initial setting) or ON and press  /ENTER.

5. Press and hold AUDIO/SETUP for at least 2 seconds to return to normal mode.

**NOTE:**

- If the received call setting on the Smartphone is on, the call will be answered automatically even though this setting is set to OFF.

**Displaying The Phone Service Provider Name**

The service provider name of the connected BLUETOOTH compatible device will be displayed. If a BLUETOOTH compatible device is not connected, "ID Unsent" will be displayed.

- **Setting item:** Service Name
1. Press and hold AUDIO/SETUP for at least 2 seconds to activate the SETUP mode.
  2. Turn the Rotary encoder to select "Bluetooth", and then press  /ENTER.

3. Turn the Rotary encoder to select Service Name and then press  /ENTER.

4. Press and hold AUDIO/SETUP for at least 2 seconds to return to normal mode.

**NOTE:**

- Depending on the character type some phone service provider name cannot be displayed. "ID Unsent" will be displayed.

**Selecting The Output Speaker**

Choose the speaker in your vehicle from which you want to hear the call.

- **Setting item:** Speaker Select

**Setting contents:**

ALL (Initial setting) / F-L / F-R / F-LR

**ALL:**

The sound be output from all of speakers in car.

**F-L:**

The sound only be output from the front left speaker.



**F-R:**

The sound only be output from the front right speaker.

**F-LR:**



The sound be output from the front left and front right speaker.

1. Press and hold AUDIO/SETUP for at least 2 seconds to activate the SETUP mode.
2. Turn the Rotary encoder to select "Bluetooth", and then press  /ENTER.

3. Turn the Rotary encoder to select Speaker Select and then press  /ENTER.
4. Turn the Rotary encoder to select either ALL (Initial setting), F-L, F-R or F-LR and press  /ENTER.
5. Press and hold AUDIO/SETUP for at least 2 seconds to return to normal mode.

**Displaying The Firmware Version**

The current firmware version will be displayed.

- **Setting item:** FW Version
1. Press and hold AUDIO/SETUP for at least 2 seconds to activate the SETUP mode.
  2. Turn the Rotary encoder to select "Bluetooth", and then press  /ENTER.
  3. Turn the Rotary encoder to select FW Version and then press  /ENTER.

4. Press and hold AUDIO/SETUP for at least 2 seconds to return to normal mode.
3. Turn the Rotary encoder to select FW Update and then press  /ENTER.

### Updating The Firmware



Future BLUETOOTH firmware updates may become available for phone interoperability.

For detailed information and operation to update your BLUETOOTH firmware, please visit Alpine home page (<http://www.alpine-usa.com>).

- **Setting item:** FW Update

#### Setting contents:

NO (Initial setting) / YES

1. Press and hold AUDIO/SETUP for at least 2 seconds to activate the SETUP mode.
2. Turn the Rotary encoder to select “Bluetooth”, and then press  /ENTER.
4. Turn the Rotary encoder to select either NO (Initial setting) or YES and press  /ENTER.
5. Press and hold AUDIO/SETUP for at least 2 seconds to return to normal mode.

### Hands-Free Phone Control

#### About The Hands-Free Phone

Hands-free calls are possible when using a HSP (Head Set Profile) and HFP (Hands-Free Profile) compatible Smartphone with this unit.

#### NOTE:

- Avoid performing a hands-free call in heavy traffic or on narrow or winding streets.



- Close the windows while calling to reduce background noise.
- If both calling parties are using hands-free devices, or the call is made in a noisy location, difficulty hearing the other person's voice is normal.
- Depending on telephone line conditions or certain mobile devices used, voices may sound unnatural.
- When using a microphone, speak as directly as you can into the microphone to pick up the best sound quality.
- Certain Smartphone features are dependent on the capabilities and settings of your service provider's network. Additionally, certain features may not be activated by your service provider, and/or the provider's network settings may limit the feature's functionality.

Always contact your service provider about feature availability and functionality.

All features, functionality, and other product specifications, as well as the information contained in the Owner's Manual are based upon the latest available information and are believed to be accurate at the time of printing.

Alpine reserves the right to change or modify any information or specifications without notice or obligation.

### Answering A Call

Incoming calls are announced by the received call ring tone and a displayed message (Phone).

Press  or press  /ENTER.

The call starts.

**NOTE:**

- When “Auto Answer” is set to ON, you can receive a call automatically. Refer to “Setting the Received Calls automatically (Auto Answer)” on page 124.
- While calling, the source sound on the unit is muted. After calling, playback will resume.

**Hanging Up The Telephone**

Press  .

The call finishes.

**NOTE:**

- You can also hang up the call by pressing  .

**Voice Control Operation**

When a Smartphone equipped with voice recognition function is paired with this unit. The Smartphone can be controlled by Voice Control via this unit.

Press and hold VOICE CTRL. for at least 2 seconds to activate the Voice Recognition mode.

After the Voice Recognition mode is activated and “Speak” is displayed, you can make a phone call, play a song, etc., via this unit by inputting voice control commands\*.

\* Please refer to your Smartphone manual for other voice control commands.

**NOTE:**

- You can perform this operation only when a Voice recognition compatible Smartphone is connected. If the Smartphone is not compatible with the Voice recognition, “No Support” is displayed for 2 seconds.
- The Voice recognition function performance depends on the recognition range of the Smartphone and mounting location of the microphone. Please pay attention when the microphone is mounted.

- Voice recognition operation depends on the function of the Smartphone. For details, refer to the Owner's Manual of the Smartphone.
- If a called person that you say is not found, "No Call" is displayed for 2 seconds.
- Please obey all local traffic laws while using this function.

### Calling

Call History is recorded for the last dialed/received/missed calls (20 records for each). There are various ways of making calls based on the "Calling". The following steps 1 to 5 are common to the various ways of making these calls. For details, refer to each individual category for making calls.

1. Press  .  
The outgoing method list is displayed.
2. Turn the Rotary encoder to select the outgoing mode.

#### **Dialed:**

Dialed history

#### **Received:**

Received history

#### **Missed:**

Missed incoming history

#### **Phone Book:**

Smartphone phone book

3. Press  /ENTER  
The outgoing mode is activated, and each mode list is displayed.

**NOTE:**

- It may take some time for the list to be displayed, and also directly after connection, the list may not be brought up to date.
4. Turn the Rotary encoder to select a name or a telephone number from the list.

**NOTE:**

- You can use Phone book alphabet search function to search a name or number from Phone Book. For details, refer to “Phone book Alphabet Search Function” on page 134
5. Press  /ENTER.

The selected telephone number will be called.

If one name has several numbers registered in the telephone book, press  /ENTER after selecting the

name\*, then turn the Rotary encoder to choose the desired number and press  /ENTER, the telephone will be called.

\* If the name cannot be recognized, “NO Name” will be displayed.



**NOTE:**

- Press  to return to the previous mode.
- If no operation is performed for 60 seconds, the unit will return to normal mode automatically.

**Redialing A Number In Outgoing History**

Previously dialed telephone numbers (maximum number of call record is 20) are stored in dialed calls history. You can redial a number by searching from dialed calls history.

- **Setting item:** Dialed

1. Press .
2. Turn the Rotary encoder to select Dialed.
3. Press  /ENTER
4. Turn the Rotary encoder to select a name or a telephone number from the list.
5. Press  /ENTER

### Dialing A Number In Incoming History

Telephone numbers (maximum number of call record is 20) from received calls are stored in the Received List. You can redial these numbers by searching here.

- **Setting item:** Received

1. Press .
2. Turn the Rotary encoder to select Received.

3. Press  /ENTER



4. Turn the Rotary encoder to select a name or a telephone number from the list.

5. Press  /ENTER

### Dialing A Number In Incoming Missed Call History

Telephone numbers (maximum number of call record is 20) for received calls that are missed, are stored in the Missed List. You can redial these numbers by searching here.

- **Setting item:** Missed



1. Press .
2. Turn the Rotary encoder to select Missed.
3. Press  /ENTER

4. Turn the Rotary encoder to select a name or a telephone number from the list.
5. Press  /ENTER

### Dialing a Number In The Phone Book

Up to 1,000 names (at most 3 telephone numbers for each name) are downloadable from a Smartphone. Dial a call by selecting a person from the phone book list.

- **Setting item:** Phone Book

1. Press .
2. Turn the Rotary encoder to select Phone Book.
3. Press  /ENTER
4. Turn the Rotary encoder to select a name or a telephone number from the list.
5. Press  /ENTER

### NOTE:

- The order of the list display depends on the setting of “PB Order” (refer to “Changing the Phone book List Order”).
- If the call history or phone book of the Smartphone is added or deleted while it is connected to the unit, the list displayed on the unit may not be brought up to date. If it is not updated, you cannot correctly place a call.
- You can display the information of a number stored in phone book by pressing  VIEW. Each press changes the display as Name → Telephone NO./ Telephone label\* → Name If the information cannot be obtained, “NO Name” or “NO Number” will display.

\* The telephone label of a number depends on the number information stored in Phone book of the Smartphone, which includes 4-type icons-(Mobile), (Home), (Work), and (Other).

### Phone Book Alphabet Search Function

You can select the first three letters to search for a desired name in phone book list by using the Phone book alphabet search function.

#### For example:



Searching a name “Michael James”.

The following example explains how the search is performed.

Depending on the setting in PB Order (refer to “Changing the Phone book List Order”), the phone book is listed in first name or last name order. Please search for the first name or last name according to the setting.

1. Press ABC SEARCH while in the phone book list, the phone book alphabet search mode is activated.
  - The letter selection screen is displayed.
2. Turn the Rotary encoder to select the first letter (e.g. M), and then press **▶▶**.
3. Turn the Rotary encoder to select the second letter (e.g. I), and then press **▶▶**.
4. Turn the Rotary encoder to select the third letter (e.g. C), and then press **🔍** /ENTER.
5. Turn the Rotary encoder to select the desired name (e.g. Michael James), and then press **🔍** /ENTER to make the call.

**NOTE:**

- If the selected name has several numbers registered in phone book, you need to turn the Rotary encoder to select the desired number, and then press  /ENTER.
- Press  in step 3 or 4 to delete the current entry and return to the previous step.
- You can search for a name by its first letter, first two letters or first three letters. Press  /ENTER after entering the desired number of letters. A list displays the names beginning with the entered letter(s).





**Call Waiting Function**

If a second call is received during a current call, you can have the first caller wait momentarily while you take the second call. When you are finished with one call, you can switch to the other one.

If a second call is received during the current call (call 1), the information of second caller (call 2) is displayed instead of the current caller's name. Press  Forward, the call waiting mode is activated.

In this case, call 1 is on hold, while you take call 2.

**NOTE:**

- In the call waiting mode, press Rewind  or  Forward to switch between the current call and the person on hold.
- In the call waiting mode, press and hold Rewind  or  Forward for at least 2 seconds to hang up call 1 or call 2, and the other call will be answered automatically. The action depends on the paired device.
- In the call waiting mode, you can press  VIEW to change the display between waiting number (1 or 2) and caller name.



### Preset A Number In The Phone Menu (Shortcut Dial)

Assign numbers that you dial frequently to presets for quick recall. You can assign up to six frequently called phone numbers to number presets.

Select a number you want to preset from the Phone Menu list (Phone Book, Dialed Call, etc.). Press and hold any one of the preset buttons (1 through 6) as the one that you wish to store the number for at least 2 seconds.

The phone number you selected is stored in presets.

#### NOTE:

- If the name has several numbers registered in the phone book, press  /ENTER after selecting the name. Turn the Rotary encoder to choose the desired number. Press and hold any one of the preset buttons (1 through 6) for at least 2 seconds. The selected number is stored as a preset number.

- A total of 18 phone numbers can be stored in the preset memory ( 6 numbers for each Smartphone in the paired device list). If a Smartphone is deleted from the paired device list, the stored preset numbers of this Smartphone are deleted, even when it is paired again.
- If you store a phone number in a preset with a previously stored number, the current number will be cleared and replaced by the new one.

### Dialing The Preset Number

1. Press any one of the preset buttons (1 through 6) that has had a number stored in the phone mode.

The information (name/number) stored in the preset station is displayed.

2. Press  /ENTER or press .

The stored preset number is dialed directly.

## Adjusting The Volume When Receiving A Call

While calling, you can adjust the volume.

Turn the Rotary encoder to adjust the volume.

### NOTE:

- You may need to increase volume from your regular audio listening source level. However, increasing the volume excessively may result in feedback. Feedback is directly related to the volume. Turning down the volume as low as acceptable, will reduce it. Positioning the microphone in a direction away from the main car speakers (e.g. clipped on sun visor) may also reduce feedback at high volume.

## Muting the Microphone Input Quickly (Voice Mute)

While calling, activating the Voice Mute function will instantly mute the microphone input. Your voice will not be heard by the caller.

While calling, press **MUTE** to mute the microphone input.

Press **MUTE** again will bring the microphone input back to its previous volume level.

## Call Switching Operation

While making a call, this function allows you to initiate the transfer of the audio between the Smartphone and the speakers in the car.

While calling, press **BAND** or press and hold **MUTE** for at least 2 seconds to switch the call sound between the unit and Smartphone.

### NOTE:

- Depending on the Smartphone, this operation may not be performed.

## Bluetooth Audio Operation

Audio information of a BLUETOOTH compatible Smartphone, a portable player, etc., is controllable/playable wirelessly\* from this unit.

\* To play back audio, a Smartphone or a portable player conforming to A2DP (Advanced Audio Distribution Profile) and AVRCP (Audio/ Video Remote Control Profile) is required.

Not all functions work with all devices.

### NOTE:





- Set “Bluetooth IN” to ON when you want to use Bluetooth Audio function. Refer to “Setting the BLUETOOTH Connection (Bluetooth IN)” on page 114.
- During a call, sound on the BLUETOOTH audio source is muted.

- If you operate the Hands-free phone (e.g. searching in the phonebook) while using the Bluetooth Audio function, BLUETOOTH Audio playback may be affected.

## Recalling The Bluetooth Audio Mode

Press  /SOURCE to select the BLUETOOTH Audio mode.

## Selecting The Desired Song

1. Press  .  
Returns the beginning of the song being played back.
2. Press  .  
Forwards the next song.  
Pressing and holding  or  will fast backward/ fast forward track continuously.

**NOTE:**

- The action depends on the paired device.

**Pausing**

Press ▶/⏸ .

Playback stops. Pressing ▶/⏸ again will resume playback.

**Selecting The Desired Group (Folder)**

Press Rewind ◀ or ▶ Forward to select the desired Group (Folder).

Pressing and holding Rewind ◀ or ▶ Forward will change folders continuously.

**NOTE:**

- This function may not be available depending on the paired device.

**Searching For A Desired Song**

Artist name, album name, etc., may be searched and displayed during playback or pause.

1. Press 🔍 /ENTER to activate the search mode.
2. Turn the Rotary encoder to select the desired Group (Folder), and then press 🔍 /ENTER.

3. Turn the Rotary encoder to select the desired album, folder, etc., within the selected Group (Folder), and then press  /ENTER.
4. Repeat step 3 if necessary until the desired song is found.

**NOTE:**

- Search mode may differ depending on the connected device.
- The pause mode may be canceled after the search.
- This function may not be available depending on the paired device.

# ACCESSORIES

## CONTENTS

---

- FLASH MEMORY (Optional) . . . . .143
  - Connecting The Flash Memory (Optional) . . . . .143
  - Playback . . . . .143
  - Repeat Play. . . . .144
  - M.I.X. (Random Play) . . . . .145
  - Searching For A Desired Song . . . . .145
  - Select Folder . . . . .146
  - Search Position Memory . . . . .147
- iPod/iPhone (OPTIONAL) . . . . .147
  - Connecting An iPod/iPhone . . . . .148
  - Setting The iPod Control . . . . .149
  - Playback . . . . .150
  - Searching For A Desired Song . . . . .150
  - Direct Search Function . . . . .153
  - Change Playlist/Artist/Album/Genre/  
Composer/Episode . . . . .155
  - Alphabet Search Function . . . . .155
  - Search Position Memory . . . . .156
  - Random Play Shuffle (M.I.X.) . . . . .156
  - Repeat Play . . . . .157
  - Displaying The Text . . . . .158

## ■ PANDORA INTERNET RADIO

- (IF EQUIPPED) . . . . .160
- Listening To Pandora . . . . .161
- “Thumbs” Feedback . . . . .161
- Searching For A Desired Station . . . . .162
- QuickMix . . . . .163

- Bookmarking A Desired Song Or Artist . . . . .163
- Creating A New Station . . . . .164
- Search Position Memory . . . . .165
- Changing The Display . . . . .165

## FLASH MEMORY (Optional)

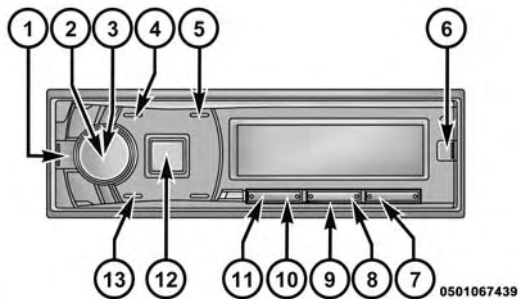

- |                    |                                     |
|--------------------|-------------------------------------|
| 1 —  ON/OFF/Return | 8 —  Repeat                         |
| 2 — Rotary Encoder | 9 — Preset Buttons<br>(1 through 6) |
| 3 —  Enter         | 10 —  Forward                       |
| 4 —  Fast Rewind   | 11 —  Rewind                        |
| 5 —  Fast Forward  | 12 —  Source                        |
| 6 —  View          | 13 —  Play/Pause                    |
| 7 —  Random        |                                     |

## Connecting The Flash Memory (Optional)

If a Flash Memory device is connected to the unit, MP3/WMA/AAC files can be played back.

### Playback

1. Press SOURCE to select the USB mode.
2. Press or to select the desired track (file). Pressing and holding or will fast backward/fast forward track continuously.
3. To pause playback, press . Pressing again will resume playback.

### NOTE:

- Any file protected by DRM (Digital Rights Management) copy protection, cannot be played back on this unit.
- The playback time may not be correctly displayed when a VBR (Variable Bit Rate) recorded file is played back.



- If there is tag information, artist name/album name/song name is displayed.
- If an MP3/WMA/AAC file contains ID3 tag/WMA tag information, the ID3 tag/WMA tag information is displayed (e.g., song name, artist name, and album name). All other tag data is ignored.
- If text information is not compatible with this unit, the display is blank.
- Before disconnecting Flash Memory, be sure to change to another source or set to pause.
- Press  View to switch the display. For additional information, refer to “Displaying the Text” on page 74.

## Repeat Play

1. Press .

The song is played back repeatedly.

RPT\*1 → RPT  \*2 → (off) → RPT

\*1 Only a file is repeatedly played back.

\*2 Only files in a folder are repeatedly played back.

2. To cancel repeat play, select (off) with the above procedure.

### NOTE:

- During repeat play, setting M.I.X. to ON will cancel the repeat play.

## M.I.X. (Random Play)

1. Press .

The songs are played back in random sequence.

MIX  \*1 → MIX ALL\*2 → (off) → MIX 

\*1 All songs in the current folder are played back in random sequence. Any one song does not play back again until all songs have been played back.

\*2 All songs in the Flash Memory are played back in random sequence. Any one song does not play back again until all songs have been played back.

2. To cancel M.I.X. play, select (off) with the above procedure.

## NOTE:

- When a song is played back during Random (M.I.X.) play in the USB mode, the song can be played back again randomly even if not all songs in the Flash Memory have been played back.
- During M.I.X. play, setting repeat play to ON will cancel the M.I.X. play.
- During repeat play, etc., the track number display for M.I.X. play may be incorrect.

## Searching For A Desired Song

Flash Memory can contain hundreds of songs. By organizing songs by folder, you can quickly find a desired folder/file. This operation is similar to search a folder/file from PC.

1. Press  /ENTER to activate the search mode.
2. Turn the Rotary Encoder to select a desired folder/file.

3. Press  /ENTER to play the selected file or enter the selected folder.

Press and hold  /ENTER for at least 2 seconds to play back all songs in the selected folder.

4. If a folder is opened in Step 3, Repeat Steps 2 to 3 until the desired folder/file is found.

#### NOTE:

- If no operation is performed for 60 seconds, the search mode is canceled.
- The root folder of Flash Memory is displayed as “\ROOT”.
- In the search mode, pressing  will return to the previous mode.
- When search is made during M.I.X. play, the M.I.X. play mode will be canceled.

- If any one of the **preset buttons (1 through 6)** is pressed in the search mode, a search can be made quickly by skipping to the specified location. For details, refer to “Direct Search Function” on page 153.

- In the search mode, a search can be made quickly by USB Skip function to find the desired folder/file. For details, refer to “Setting the USB Skip function” on page 104.

- The total folders/files should be less than 1,000 (512 files for root folder) in each search hierarchy.

#### Select Folder

Folder can be easily changed. For example, if you listen to a song from a selected folder, the folder can be changed.

Press Rewind  or  Forward to select the desired Folder.

**NOTE:**

- This function is inactive during MIX ALL playback.







**Search Position Memory**

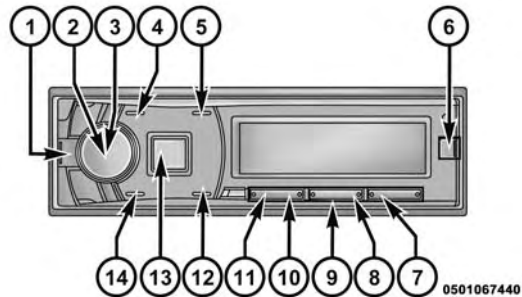



During playback, you can quickly return to the last-selected hierarchy level in the search mode.

Press .

The hierarchy you selected last in the search mode is displayed.

**iPod/iPhone (OPTIONAL)**

- 1 —  Return
- 2 — Rotary Encoder
- 3 —  Enter
- 4 —  Fast Rewind
- 5 —  Fast Forward
- 6 —  View
- 7 —  Random
- 8 —  Repeat

- 9 — Preset Buttons  
(1 through 6)
- 10 —  Forward
- 11 —  Rewind
- 12 — Band/ABC Source
- 13 —  Source
- 14 —  Play/Pause

## Connecting An iPod/iPhone

An iPod/iPhone can be connected to this unit by using the Interface cable for iPod (included with iPod/iPhone). When this unit is connected by using the cable, the controls on the iPod are not functional.

### NOTE:

- Internet and telephone functions of the iPod touch or iPhone, etc., can also be used while connected to this unit. However, using these functions will stop or pause the playing songs. Stop using any applications or the phone functions before going back to music playback on your device.
- If you connect an iPhone to this unit, it can be used as an iPod. If you use iPhone as a hands-free phone, use the unit in which the BLUETOOTH function is built.

## About iPod/iPhone models usable with this unit

- Confirmed devices regarding Made for iPod. Correct function of earlier versions cannot be guaranteed.

iPod touch (4th generation): Ver.5.1.1

iPod nano (6th generation): Ver.1.2

iPod touch (3rd generation): Ver.5.1.1

iPod nano (5th generation): Ver.1.0.2

iPod classic (160 GB) (Late 2009): Ver.2.0.4

iPod touch (2nd generation): Ver.4.2.1

iPod nano (4th generation): Ver.1.0.4

iPod classic (120 GB): Ver.2.0.1

iPod touch (1st generation): Ver.3.1.3

iPod nano (3rd generation): Ver.1.1.3

iPod classic (80 GB, 160 GB): Ver.1.1.2

- Confirmed devices regarding Made for iPhone. Correct function of earlier versions cannot be guaranteed.

iPhone 4S: Ver.5.1.1

iPhone 4: Ver.5.1.1

iPhone 3GS: Ver.5.1.1

iPhone 3G: Ver.4.2.1

iPhone: Ver.3.1.3

- For clarity in identifying your model of iPod, please see Apple's own document "Identifying iPod models" at <http://support.apple.com/kb/HT1353>.
- This unit does not support video playback from iPod/iPhone, even using a video-compatible cable.

## Setting The iPod Control

When an iPod/iPhone is connected, operate it from its own controls or from the head unit.

1. Press and hold  /ENTER/OPTION for at least 2 seconds in the iPod mode.

The Option menu for iPod mode is activated.

2. Turn the Rotary Encoder to select " **APP Direct**", and then press  /ENTER.

The iPod control mode will switch between iPod Mode and HU Mode.

### HU Mode (HEAD UNIT):

Operate the iPod/iPhone via this unit.

### iPod Mode:

Operate the iPod/iPhone using its own controls. When iPod is selected, some functions will not be operable via the head unit.

**NOTE:**

- During HU Mode, you can switch to iPod Mode directly by pressing **BAND**.
- Once the control mode is changed, this will set pause status, press **▶/||** to continue.
- Depending upon the iPod used, iPod control may not be selectable. Or, if iPod is selected, operation must still be from the head unit.

**Playback**

1. Press **☐** SOURCE to switch to the iPod mode.
2. Press **◀◀** or **▶▶** to select the desired song.  
Pressing and holding **◀◀** or **▶▶** will fast backward/fast forward the current song.
3. To pause playback, press **▶/||**.  
Pressing **▶/||** again will resume playback.

**NOTE:**

- A song playing on the iPod/iPhone while it is connected to this unit will continue to play from where it was paused after disconnection.
- If you listen to an episode from a selected podcast or audiobook, the episode can be changed by pressing Forward **◀** or **▶** Rewind.
- An episode may have several chapters. The chapter can be changed by pressing **◀◀** or **▶▶**.

**Searching For A Desired Song**

An iPod/iPhone can contain hundreds of songs. This unit utilizes various methods to make searches for desired content as simple as possible.

Each music category has its own individual hierarchy as shown below. Choose a music category from the list below to narrow searches quickly.



Hierarchy 1	Hierarchy 2	Hierarchy 3	Hierarchy 4
Playlist	Song	—	—
Artist*	Album*	Song	—
Album*	Song	—	—
Song		—	—
Podcast	Episode	—	—
Genre*	Artist*	Album*	Song
Composer*	Album*	Song	—
Audiobook	—	—	—
Genius Mix list	—	—	—

**For example:**

Searching by Artist name.

The following example explains how an Artist search is performed.

Another search mode can be used for the same operation, although the hierarchy differs.

1. Press  /ENTER to activate the search selection mode.
2. Turn the Rotary encoder to select the Artist search mode, and then press  /ENTER.





Shuffle All\*1 ↔ Playlist ↔ Artist ↔ Album  
 ↔ Song ↔ Podcast ↔ Genre ↔ Composer ↔ Au-  
 diobook ↔ Genius Mix\*2/\*3 ↔ Shuffle All\*1

\*1 Refer to “Random Play Shuffle (M.I.X.)” on page 156.



\*2 Depending on the connected iPod/iPhone, Genius Mix function may not be supported.



\*3 When an iPod/iPhone with Genius Mix list created by iTunes is connected to this unit, Genius Mix search mode can be used to search a Genius Mix list.

3. Turn the Rotary encoder to select the desired Artist, and then press  /ENTER.
4. Turn the Rotary encoder to select the desired Album, and then press  /ENTER.
5. Turn the Rotary encoder to select the desired Song, and then press  /ENTER.

The selected song is played back.

#### NOTE:

- After pressing and holding  /ENTER for at least 2 seconds while in each hierarchy (except Song, Audiobook and Genius Mix list hierarchy), all songs of the selected hierarchy are played back.
- After selecting [All] in the search mode, press and hold  /ENTER for at least 2 seconds to play back all songs in the iPod/iPhone or selected search mode.
- If no operation is performed for 60 seconds, the search mode is canceled.
- In the search mode, pressing  will return to the previous mode.
- When search is made during M.I.X. play, the M.I.X. play mode will be canceled.

- “No Song” will be displayed if there are no songs in the selected playlist in the Playlist search mode.
- “No Podcast” will be displayed if there is no podcast data in the iPod/ iPhone in the Podcast search mode.
- “No Audiobook” will be displayed if there is no audiobook data in the iPod/iPhone in the Audiobook search mode.
- “No Genius” will be displayed if there is no genius mix list data in the Genius Mix search mode.
- If “iPod name” stored in the iPod/iPhone is selected in the desired Playlist search mode, and  /ENTER is pressed, you can search for all songs in the iPod/iPhone. Also, if you press and hold  /ENTER for at least 2 seconds, all songs in the iPod/iPhone are played back.
- Depending on the iPod/iPhone, podcast search is not supported.
- During search mode, a search can be made quickly by Alphabet search function to find the desired artist or song, etc. For details, refer to “Alphabet search function” on page 155.
- If any one of the **preset buttons (1 through 6)** is pressed in the search mode, a search can be made quickly by skipping to the specified location. For details, refer to “Direct Search Function” on page 153.
- During search mode, a search can be made quickly by Alphabet search function to find the desired artist or song, etc. For details, refer to “Alphabet search function” on page 155.

### Direct Search Function

Direct search can be used to jump a fixed percentage of titles within the current search category (album, song, etc.).

In the search mode, press any one of the preset buttons (1 through 6) to quickly skip over a designated percent of your song content.

#### Song search example:

If there are 100 songs in your iPod/iPhone, they are divided into 6 groups using percentages (shown below). These groups are assigned to preset buttons 1 through 6.

#### Example 1:

Suppose the song you are searching for is located at around the middle (50%) of your library: press button 4 to jump to the 50th song and turn the Rotary Encoder to find the desired song.

#### Example 2:

Suppose the song you are searching for is located near the end (83%) of your library: press button 6 to jump to the 83rd song and turn the Rotary Encoder to find the desired song.

	All 100 songs (100%)					
	0%	17%	33%	50%	67%	83%
Preset buttons	1	2	3	4	5	6
Songs	1st song	17th song	33rd song	50th song	67th song	83rd song

**NOTE:**

- This function is also applicable to CD/MP3/WMA/AAC search.
- This function is inactive during Alphabet Search mode.
- This function is unavailable when Genius Mix list is selected.

### **Change Playlist/Artist/Album/Genre/ Composer/Episode**

Playlist/Artist/Album/Genre/Composer/Episode can be easily changed. For example, if you listen to a song from a selected album, the previous or next album can be selected.

Press Rewind ◀ or ▶ Forward to change to the previous or next Playlist/Artist/Album/Genre/Composer/Episode.

**NOTE:**

- If the song search mode was used to select a song, this function is inactive.
- If an album is selected during an artist search, other albums by that artist are searchable.
- This function is inactive during shuffle (M.I.X.) playback.

### **Alphabet Search Function**

Use the alphabet search function to search for an album, song, etc., by its first letter. Select the first letter of the desired title (album, song, etc.), and the titles beginning with this letter are listed.

1. In the search mode, press ABC SEARCH. The letter selection list is displayed.

2. Turn the Rotary Encoder to select a desired letter (e.g. M), and then press  /ENTER.

The titles beginning with “M” are listed.

3. Turn the Rotary Encoder to select the desired title.

#### NOTE:

- While in Alphabet search mode, pressing  will return to the previous mode.
- If the Playlist search mode is used to search for a song, the Alphabet search function is inactive in the song search hierarchy.
- This function is unavailable when Genius Mix list is selected.

#### Search Position Memory

During iPod/iPhone playback, you can quickly return to the last-selected hierarchy level in the search mode.

Press  .

The hierarchy you selected last in the search mode is displayed.

#### Random Play Shuffle (M.I.X.)

The Shuffle function of the iPod/iPhone is displayed as M.I.X. on this unit.

#### Shuffle Albums:



The songs on each album are played back in proper order. Upon completion of all the songs on the album, the next album is selected randomly. This continues until all albums have been played.

#### Shuffle Songs:

Song shuffle randomly plays back songs within a selected category (playlist, album, etc.). The songs within the category are played just once until all songs have been played.

1. Press .

The songs are played back in random sequence.

MIX  \*1 → MIX\*2 → (off) → MIX 

\*1 Shuffle Albums.

\*2 Shuffle Songs.

2. To cancel M.I.X. play, select (off) with the above procedure.

#### NOTE:

- If a song is selected in the album search mode before selecting M.I.X. play, the songs will not play back randomly even when Shuffle Albums is selected.

#### Shuffle All:

Shuffle All plays all songs in the iPod/iPhone randomly. Any one song does not play back again until all songs have been played back.

1. Press  /ENTER to activate the search selection mode.

2. Turn the Rotary Encoder to select Shuffle All, and then press  /ENTER.

To cancel M.I.X. play, press  to select OFF.

#### NOTE:

- If Shuffle All is selected, the selected songs being played back in the search mode are canceled.

#### Repeat Play

Only Repeat One is available for the iPod/iPhone.

**Repeat One:**

A single song is repeatedly played back.

1. Press .

The song is played back repeatedly.

RPT\* → (off) → RPT

\* Repeat One.

2. To cancel repeat play, select (off) with the above procedure.

**NOTE:**

- Depending on the connected iPod, track up/down may be not available during Repeat play.

**Displaying The Text**

You can display the tag information of a song in the iPod/iPhone.

Press  VIEW.

Each press changes the display.

**NOTE:**

- When the Text Scroll is set to Manual (refer to “Scroll Setting (Text Scroll)” on page 98), press and hold  VIEW for at least 2 seconds, the current text will be scrolled one time.

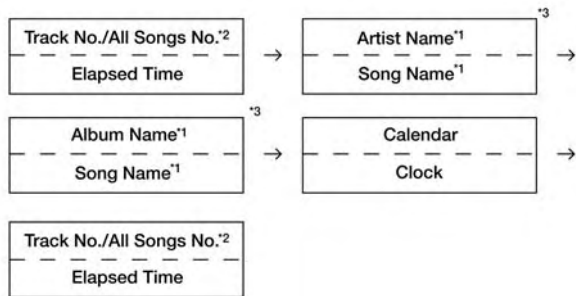

0501067442

\*1 TAG information If the Text Scroll (refer to “Scroll Setting (Text Scroll)” on page 98 ) is set to “Auto,” the tag information will scroll automatically. If there is no text information, nothing will be displayed.

\*2 The numbers of all songs displayed vary depending on the songs selected by the search.

\*3 When the Text Scroll (refer to “Scroll Setting (Text Scroll)” on page 98. ) is set to “Auto,” the display cannot be switched by pressing  VIEW. The display contents switch alternately.

#### NOTE:

- Only alphanumeric characters (ASCII) can be displayed.
- The maximum number of characters for the head unit is 64 (64 byte).
- Some characters may not be correctly displayed.
- The display is blank when text information is not compatible with this unit.

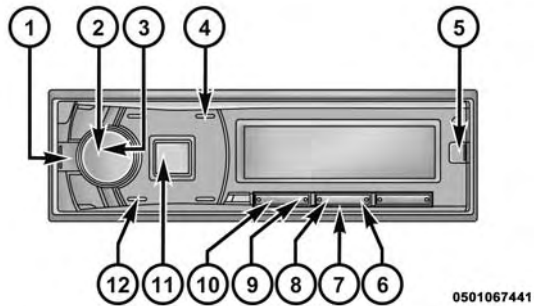

**PANDORA INTERNET RADIO (IF EQUIPPED)**

1 — ↩ Return

2 — Rotary Encoder

3 — 🔍 Enter

4 — ⏩ Fast Forward

5 — 👁 View

6 — 📺 New Station

7 — Preset Buttons

(1 through 6)

8 — 📌 Bookmark

9 — 👍 Thumbs Up

10 — 👎 Thumbs Down

11 — 📺 Source

12 — ⏸ Play/Pause

Pandora internet radio is your own FREE personalized radio now available to stream music on your Smartphone (which runs Android OS or iOS).

Just start with the name of one of your favorite artists, songs or classical composers and Pandora will create a “station” that plays their music and more music like it.





The unit enables you to interact with your Pandora account by connecting a Smartphone that has the latest version of the Pandora application installed.

**NOTE:**

- Some Pandora application functions are not available when using this unit.
- Pandora is also controllable from an iPod touch with Wi-Fi connection.
- Pandora is available on iOS and Android OS with this unit.

- Before this operation, set ALPINE APP to USB or BT depending on the connected Smartphone. For details, refer to “Application Setting (APP)” 106.
- The unit remembers the source just before turning off the power. If Pandora is the last SOURCE to be played, it will appear as the SOURCE the next time the unit is power up even if the app is not launched on your Smartphone.

### Listening To Pandora

1. Launch the Pandora Application on the Smartphone.
2. Press  /SOURCE to switch to the Pandora mode.
3. To pause playback, press . Pressing  again will resume playback.
4. To skip to the next song, press .
- Pandora audio could drop out in areas with poor phone coverage.
- The display content varies when ads are received.
- The playback time may not be correctly displayed.



### NOTE:



- The operation to replay a previous song is not available.
- Pandora limits the number of skips allowed on their service. If you attempt to skip songs beyond the limit, “Skip Limit” is displayed.

### “Thumbs” Feedback

You can personalize your stations with “Thumbs Up” or “Thumbs Down” feedback, which the system takes into account for future music selections.

During playback, press  or  for thumbs up or thumbs down.

 : The  icon appears in the display. Pandora will add similar music to your station.

 : The  icon is displayed. Pandora will ban that song from your station, and the current song is skipped. If the number of skips allowed has reached its limit, the current song continues to play back.



#### NOTE:

- In some situations, “Thumbs” feedback may not be available.

### Searching For A Desired Station

You can display your station list and select stations directly from this unit.



Alphabet Search:

1. Press  /ENTER to activate the Search mode.
2. Turn the Rotary encoder to select “A-Z”, and then press .

The “A-Z” search mode is activated and the station names are listed alphabetically.

3. Turn the Rotary encoder to select the desired station, and then press  /ENTER.  
Pandora will play that station.

#### Search by Date Added:

1. Press  /ENTER to activate the Search mode.
2. Turn the Rotary encoder to select “By Date”, and then press .

The “By Date” search mode is activated and the station names are listed by the date they were added to the account.



3. Turn the Rotary encoder to select the desired station, and then press .
- Pandora will play that station.

**NOTE:**

- If any one of the **preset buttons (1 through 6)** is pressed in the search mode, a search can be made quickly by skipping the specified number of channels. For details, refer to “Direct Search Function” on page 153.

**QuickMix**

Use QuickMix to create a playlist based on two or more of your Pandora stations. Edit your QuickMix station selections on the Pandora Compatible Application for iPhone when it is not connected to this unit.

1. Press  /ENTER to activate the Search mode.
2. Turn the Rotary encoder to select “A-Z” or “By Date”, and then press  /ENTER.

The “A-Z” or “By Date” search mode is activated and the station name is displayed.



3. Press  /ENTER while selecting “QuickMix”.

**NOTE:**

- The songs from the created stations are played back in random sequence.
- Select another station during search mode to cancel QuickMix.

**Bookmarking A Desired Song Or Artist**

The currently playing track or artist can be bookmarked and saved to your Pandora account.



1. During playback, press  (Bookmarks).  
The Pandora Bookmark screen is displayed.
2. Turn the Rotary encoder to select “Track (Bookmark)” or “Artist (Bookmark)”, and then press  /ENTER.  
The current track or artist is bookmarked. “Bookmark Track” or “Bookmark Artist” is displayed.

**NOTE:**

- Your bookmarks can be viewed on your “Profile” page at [www.pandora.com](http://www.pandora.com).
- In some situations, bookmarks may not be available.
- When Bookmark operation is failed, Bookmark N/A will be displayed.

**Creating A New Station**

Based on currently playing track or artist, you can create a new station and save to your Pandora account.

1. During playback, press  (New Station).  
The Pandora New Station screen is displayed.
2. Turn the Rotary encoder to select “Track” or “Artist”, and then press  /ENTER.

A “New Track” or “New Artist” pop-up screen.

A New Station based on current track or artist is created.

**NOTE:**

- Your New Station can be viewed on your “Profile” page at [www.pandora.com](http://www.pandora.com).
- In some situations, creating a new station function may not be available.
- If this operation fails, N/A will be displayed.
- When the Smartphone is not connected to this unit, you can create personalized Pandora stations using the Pandora Application on your Smartphone. You can also create stations on the web at [www.pandora.com](http://www.pandora.com).

## Search Position Memory

During playback, you can quickly return to the last-selected hierarchy level in the search mode.

Press .

The hierarchy you selected last in the search mode is displayed.

## Changing The Display

Press  VIEW.

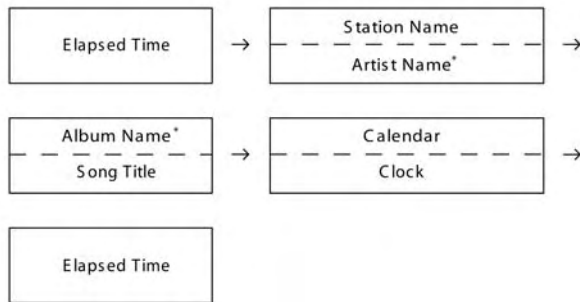

0501067446





\* TAG information If there is no text information, nothing will be displayed.

### NOTE:

- The maximum number of characters is 64 (64 byte).
- Some characters may not be correctly displayed.

### About The Indication Display

When displaying Text, the following indicators are illuminated according to the mode.

Indicator/Mode	Pandora Mode
	Station Name being displayed
	Artist Name being displayed
	Album Name being displayed
	Song Name being displayed

# SiriusXM SATELLITE RADIO OPERATION (OPTIONAL)

## CONTENTS

---

■ SiriusXM SATELLITE RADIO OPERATION (OPTIONAL) . . . . .	168
□ Receiving Channels With The SiriusXM Tuner .168	
□ SiriusXM Setting . . . . .	169
□ Managing Artist And Song Alerts . . . . .	170
□ Setting The Favorite Sports Team Alerts. . . . .	171
□ Setting The Parental Control. . . . .	172
□ Confirming The Strength Of The SiriusXM Signal. . . . .	174
□ Checking The SiriusXM Radio ID Number. . . . .	175
□ Storing Channel Presets . . . . .	175
□ Tuning Channels Using Presets . . . . .	176
□ Storing The Desired Artist And Song Alerts . . .176	
□ Receiving And Tuning To An Alert . . . . .	178
□ Search Function. . . . .	178
□ Using Jump Memory And Jump Recall Function .180	
□ Replay Function . . . . .	181
□ Parental Lock Function. . . . .	181
□ Storing iTunes Tagging Information. . . . .	182
□ Changing The Display . . . . .	183



## SiriusXM SATELLITE RADIO OPERATION (OPTIONAL)

SiriusXM Tuner operation:

### WARNING!

**Always drive safely with your hands on the steering wheel and obey all applicable laws. You have full responsibility and assume all risks related to the use of the features and applications in this vehicle. Only use the features and applications in this vehicle when it is safe to do so. Failure to do so may result in an accident involving in serious injury or death.**

When a SiriusXM Tuner is connected to this unit, the following operations may be performed.

## Receiving Channels With The SiriusXM Tuner

### About SiriusXM Satellite Radio

Everything worth listening to is on SiriusXM. Get over 130 channels, including the most commercial-free music, plus the best sports, news, talk and entertainment. A SiriusXM Tuner and Subscription are required. For more information, visit [www.siriusxm.com/activatenow](http://www.siriusxm.com/activatenow), or call 866-635-2349.

To activate SiriusXM Canada service, go [www.xmradio.ca](http://www.xmradio.ca) and click on "ACTIVATE RADIO" in the top right corner, or call 877-438-9677.

### NOTE:

- The SiriusXM Satellite Radio controls on this unit are available only when a SiriusXM Tuner is connected.
1. Press  /Source to activate the Satellite Radio (SiriusXM) mode.

2. Press **◀** or **▶** to select the desired channel.

Holding down **◀** or **▶** will rapidly browse through the channels.

Alternatively, you can enter the number of the desired channel using the numeric keypad on an optional remote control.

### SiriusXM Setting

The following steps 1 to 5 are common to the various SiriusXM functions. For details, refer to each individual function.

1. Press and hold AUDIO/SETUP for at least 2 seconds to activate the SETUP mode.
2. Turn the Rotary encoder to select "SiriusXM", and then press **Q** /Enter.

The SiriusXM setup mode is activated.

3. Turn the Rotary encoder to select the desired items and then press **Q** /Enter.

### SiriusXM:

Alert Setup ↔ Games Alert Setup ↔ Parental Lock ↔ Signal Indicator ↔ Alert Setup

4. Turn the Rotary encoder to change the settings.
5. Press and hold AUDIO/SETUP for at least 2 seconds. The SETUP mode is canceled.

### NOTE:

- Press **↶** to return to the previous mode.
- If no operation is performed for 60 seconds, the unit will return to normal mode automatically.

## Managing Artist And Song Alerts

The following operations can be performed to change the Alert settings. The Artist and Song Alerts feature allows you to mark Artists and Songs from the current channel and then the unit alerts you later when the marked Artists or Songs are playing on other channels.

- **Setting item:** Alert Setup

### Setting contents:

Alert List / Alert / All Source Alert / Delete All

### Alert List

This menu option allows you to enable the Artist/Song alert for individual Artist/Songs (ON or OFF) or to delete individual stored Artist/Song alerts (Delete).

1. Turn the Rotary encoder to select Alert List, and then press  / ENTER.

2. Turn the Rotary encoder and select a stored Artist or Song and press  / ENTER.
3. Turn the Rotary encoder to select either Alert to enable (ON) or disable (OFF) the alert for the selected Artist/Song or turn the Rotary Encoder to select Delete to delete the selected Artist/Song from memory

### Alert

This menu option allows you to temporarily disable the Artist/Song Alerts for all Artists/Songs. When the Alerts are re-enabled, individual Artist/Song Alert disabled in the Alert List menu setting remain disabled.

Turn the Rotary encoder to select ON or OFF, and then press  /ENTER.

If ON is set, the alert for all stored Artists/Songs is enabled.

If OFF is set, the alert for all stored Artists/Songs is disabled.

### All Source Alert

This menu option allows you to enable the alerts of all sources.

Turn the Rotary encoder to select ON or OFF, and then press  /ENTER.

If ON is set, the alert of all source is enabled.

If OFF is set, only the alert of SiriusXM source is enabled.

### Delete All

This operation will delete all alerts (artists, songs and team) stored in memory.



After selecting this item, turn the Rotary encoder to select YES, and then press  /ENTER.

## Setting The Favorite Sports Team Alerts

This menu option allows you to select your favorite teams, organized by leagues, so that you will be alerted later when your favorite teams are playing on other channels.

- **Setting item:** Games Alert Setup

After selecting Games Alert Setup, a sports league list will be displayed.

1. Press and hold AUDIO/SETUP for at least 2 seconds to activate the SETUP mode.
2. Turn the Rotary encoder to select "SiriusXM", and then press  /ENTER.  
The SiriusXM setup mode is activated.
3. Turn the Rotary encoder and select Games Alert Setup and press  /ENTER.

After selecting Games Alert Setup, a sports league list will be displayed.

4. Turn the Rotary encoder to select the desired league and press **Q** /ENTER.
5. Turn the Rotary encoder to select a team you want to store, and then press **Q** /ENTER.
  - A “Team Saved” pop-up screen is followed by an “X U(sed)/Y E(mpty)”.
  - X is the total number of Artist/Song/Game alert items stored in memory, and Y is the total number of memory slots still available for storage.
6. Press and hold AUDIO/SETUP for at least 2 seconds to return to normal mode.

**NOTE:**

- Select “None” on the team list if you do not want to store in memory.

## Setting The Parental Control

You can lock out channels with passcode protection. Channels that are locked cannot be accessed without entering the pass code. You can unlock a channel or change the pass code using this menu option.

- **Setting item:** Parental Lock

**Setting contents:**

Clear All / Locked Channels / Edit Code

### How to input pass code?

1. After select Parental Lock, a pass code input screen will be displayed.
2. Input the pass code using the Rotary encoder.
 

The initial default 4-digit pass code is set to 0000.

The pass code is entered one digit at a time with the Rotary encoder. For example, by turning clockwise 2 steps, the number 1 is selected.

After entering the digit, it is displayed as \* (asterisk).

3. Press **▶▶**, and then input the next digit of the pass code as described in step 2.

Press **◀◀** to delete the current entry return to the previous step.

4. Repeat steps 2 to 3 until the 4 digits of the pass code are entered, and then press **Q / ENTER**.

After the correct pass code is entered, the Clear All/Locked Channels/Edit Code items can be adjusted.

#### **Clear All:**

Unlock all locked channels.

Turn the Rotary encoder to select YES, and then press **Q / ENTER**.

#### **Locked Channels:**

After selecting this item, turn the Rotary encoder to select a channel from channel list, press **Q / ENTER** to select to lock or unlock the channel. Locked channels cannot be tuned without entering the pass code.

The locked channel will be displayed with “L” before channel No.

#### **Edit Code:**



Change the pass code.

Input the old pass code as steps 1 to 4 in “How to input pass code?”.

After the old pass code is entered, the new pass code input screen will be displayed.

Input the new pass code as steps 1 to 4 in “How to input pass code?”.

A confirm screen will be displayed and the new passcode must be entered again for confirmation. When the passcode is changed successfully, the unit will display Code Saved.

1. Press and hold AUDIO/SETUP for at least 2 seconds to activate the SETUP mode.
2. Turn the Rotary encoder to select “SiriusXM”, and then press  / ENTER.  
The SiriusXM setup mode is activated.
3. Turn the Rotary encoder and select Parental Lock and press  / ENTER.
4. Turn the Rotary encoder to select either Clear All, Locked Channels or Edit Code, and press  / ENTER.

**NOTE:**

- Keep a note of the numbers somewhere safe in case you should forget it.

**Confirming The Strength Of The SiriusXM Signal**

You can check the signal strength through this setting item.

- **Setting item:** Signal Indicator

**Signal content**

Setting Indicator

**Setting Indicator:**

This menu item displays the SiriusXM signal strength as Strong, Good, Weak or No Signal.

**NOTE:**

- If the Signal Indicator reports Weak or No Signal and your vehicle is parked outside with no obstructions to the southern sky, then your SiriusXM antenna may not be properly installed or may have become damaged.

**Checking The SiriusXM Radio ID Number**

To subscribe to the SiriusXM Satellite Radio service, it is necessary to locate and identify the Radio ID of your SiriusXM Tuner. The Radio ID contains 8 characters and can be found on the bottom of your SiriusXM Tuner or can be displayed on when selecting Channel 0 by following the steps below:

1. While in the Satellite Radio Mode, press ◀◀ or ▶▶ to select channel "0".

The unit displays "RADIO ID" and ID number at the same time.

**NOTE:**

- The Radio ID does not include the letters I, O, S or F.
2. To cancel the ID number display, select a channel other than "0".

**Storing Channel Presets**

1. Press BAND to select the desired band you want to store the preset in.

There are 3 Satellite Radio Preset bands.

Each press of BAND changes the band: SiriusXM1 → SiriusXM2 → SiriusXM3 → SiriusXM1

2. Tune to the desired channel, and then press and hold (for at least 2 seconds) one of the preset buttons (1 through 6) to store the channel.

The display then shows the stored Band and preset number (for example, SiriusXM1-3 is shown when preset 3 of BAND1 is selected).



3. Repeat the procedure to store up to 5 other channels onto the same band.

**NOTE:**

- A total of 18 channels can be stored in the preset memory, 6 Channels for each band (SiriusXM1, SiriusXM2 and SiriusXM3).
- If you store a new channel into a preset which already has a channel assigned, the current channel will be cleared and replaced with the new one.

**Tuning Channels Using Presets**

1. Press BAND to select the desired band of Presets you wish to access.
2. Press the preset buttons (1 through 6) that has your desired Satellite Radio channel stored in memory.

**Storing The Desired Artist And Song Alerts**

While listening to SiriusXM Satellite Radio, you can be alerted when your favorite songs or artists are playing on other channels. An interruption Alert will be displayed when a matching artist or song is found on another channel. For receiving interruption Alert information, refer to “Receiving and Tuning to an Alert” on page 178.

1. Press and hold  /ENTER/OPTION for at least 2 seconds when a Song or the song of an Artist you want to store is playing.

The Option mode is activated.

2. Turn the Rotary encoder to select Alert Memory, and then press  /ENTER.

- Turn the Rotary encoder to choose Save Artist? or Save Song? (when available), and then press  /ENTER.

**NOTE:**



- If both the artist name and song title are not available to save, Artist/Song will be displayed.

- The new alert was stored in memory.

An “Artist/Song Saved” pop-up screen is followed by an “X U(sed)/Y E(mpty)”.

X is the total number of song titles or artist names stored in memory, and Y is the total number of memory locations still available for storage.

**NOTE:**

- If you try to store when the memory is full, “Memory Full” is displayed followed by “Replace/Cancel”. If you want to replace an existing alert item, select “Replace” by turning Rotary encoder, and then press  /ENTER, the existing alert list stored in memory is displayed. Select one of the stored alerts using the Rotary encoder. To replace the selected alert, press  /ENTER and an “Artist/Song Saved” pop-up screen is followed by an “X U(sed)/Y E(mpty)”.
- You can manage the stored Alert memory setting on Setup mode, for details, refer to “Managing Artist and Song Alerts” on page 170.
- If no operation is performed for 60 seconds, the setting mode is canceled.

## Receiving And Tuning To An Alert

Whenever a stored sports team, artist, or song is playing on another channel, an interruption Alert appears on the unit display. To tune to the game, artist or song identified by the alert, follow the steps below:



1. Turn the Rotary encoder to select the desired game, artist or song from the list of active alerts.
2. Press  /ENTER.

### NOTE:



- If no operation is performed for 5 seconds, the unit returns to normal mode.
- Sports teams/Artist name and Song title which you have stored and which are currently playing will be displayed in a category called “My Music”/“My Games” in search mode. For details, refer to “Search Function” on page 178.

## Search Function

You can search for SiriusXM programming content by Category or by Channel.

1. Press  /ENTER in the SiriusXM mode.
2. Turn the Rotary encoder to select the desired Category, and then press  /ENTER.
3. Turn the Rotary encoder to select the desired Channel Name, and then press  /ENTER.

### Searching by Channel



1. Turn the Rotary encoder to select All Channels after step 1, and then press  / ENTER.  
All Channels will be displayed in a list.
2. Turn the Rotary encoder to select the desired channel, and then press  / ENTER to confirm.

**NOTE:**

- Press  VIEW, the information of the broadcasting channels will be displayed. You can choose the desired channel from the artist name list or song name list.

Each time you press  VIEW, the display changes as below.

Channel number/Channel name → Channel number/  
Artist name → Channel number/Song name → Chan-  
nel number/Channel name

- During channel search, pressing 1  or  2 to select another Category.

**Searching by My Music**

1. Turn the Rotary encoder to select My Music\* after step 1, and then press  / ENTER.



The artist names and song names that you have stored and are currently playing will be displayed in a list.

\* Displayed only when the stored song or artist is broadcasting.

2. Turn the Rotary encoder to select the desired artist/song, and then press  / ENTER to confirm.

The channel of the selected artist/song being broadcast is received.

**NOTE:**

- Press  VIEW, the information of the broadcasting channels will be displayed. You can choose the desired channel from the artist name list or song name list. Each time you press  VIEW, the display changes as below. Channel number/Channel name → Channel number/Artist name → Channel number/Song name → Channel number/Channel name.

## Searching By My Games

1. Turn the Rotary encoder to select My Games\* after step 1, and then press  / ENTER.

The sport teams that you have stored and the game is currently broadcasting will be displayed in a list.

\* Displayed only when the game of stored team is broadcasting.

2. Turn the Rotary encoder to select the desired team, and then press  / ENTER to confirm.

The channel of the selected game being broadcast is received.

### NOTE:

- The Search mode is canceled if no operation is performed for 60 seconds in Search mode.
- Press  in the search mode to return to the previous mode.

## Using Jump Memory And Jump Recall Function

1. While in SiriusXM mode, select your favorite SiriusXM Channel.
2. Press and hold  for at least 2 seconds.  
The channel you selected is stored as the Jump Source.
3. Press and hold BAND for at least 2 seconds to recall, and then tune to the saved Jump Source channel.

### NOTE:

- Pressing and holding BAND again for at least 2 seconds will jump back to the previous mode or SiriusXM channel.
- During saved Jump Source channel playing, search function, channel up/down, etc. are not available.

## Replay Function

In SiriusXM mode, you can pause, rewind and replay of live SiriusXM Satellite Radio.

1. While listening to a SiriusXM channel, press **▶/||** to enter the Replay mode, which mutes the audio.

The display will show “ **||** ” while in this mode.

2. Press **▶/||** again to resume playback of the stored audio from the point at which it was paused.

During playback, the SiriusXM Tuner will continue to store the channel audio until you exit the Replay mode.

During REPLAY playback:

- Fast rewind:  
Press and hold **⏮**.
- Fast forward:  
Press and hold **⏭**.

- Returning to the beginning of the current song: Press **⏮**.
- Advancing to the beginning of the next song: Press **⏭**.

### NOTE:



- If you continue to press Fast forward until the end, the Replay mode is canceled, and the unit will change to live SiriusXM radio mode.
  - If you change channels while in Replay mode, the unit will exit Replay mode to live Satellite Radio mode and clear the Replay memory.
3. Press **↵** to cancel the REPLAY mode.  
The unit returns to live SiriusXM radio mode.

## Parental Lock Function

This function can help restrict the listening of channels to children of appropriate age levels only. For information on setting the Parental Control passcode, refer to “Setting

the Parental Control” on page 172. When a locked channel is selected, a “Channel Locked” pop-up screen is displayed.

Input the 4-digit passcode you set in, and then press  /ENTER, refer to “Setting the Parental Control” on page 172.

Turn the Rotary encoder to select the number from 0-9, and then use  or  to adjust the digit. The initial number is 0000.

#### NOTE:

- If you input a wrong passcode, “Wrong Code” is displayed.
- After entering the correct passcode, you can access all locked channels without entering the passcode again until the unit is powered off and then back on.

## Storing iTunes Tagging Information

iTunes Tagging lets you tag songs heard on SiriusXM channels. Use this unit in conjunction with an optional SiriusXM Tuner and a Tagging compatible iPod/iPhone to tag the music that you listen to. This tag information is automatically transferred to your iPod/iPhone. Later, when your iPod/iPhone is connected to iTunes, you can preview, buy and download your tagged songs. For details, refer to the Owner’s Manual of the Tagging compatible iPod/iPhone.

The Tag indicator will light when a song playing on a SiriusXM channel has tag information available.

Press and hold  VIEW for at least 2 seconds to save its tag information.

If no iPod/iPhone is connected, “Tag Count X” is displayed (X is the total amount of the tag information stored in this unit).

**NOTE:**

- During tagging, the iPod/iPhone takes priority to save the tag information. If no iPod/iPhone is connected, the tag information is saved to this unit.
- When the memory of iPod/iPhone is full, “iPod Full” and “Tag Count X” are displayed. The tag information will be stored to the unit.
- If the operation is failed, “Cannot Tag” is displayed.
- This unit can store up to 50 tagged songs. When the memory of the unit is full, “Tag Count50” and “Memory Full” are displayed.
- When an iPod that doesn’t support the tagging function is connected, “Non-Tagging iPod” is displayed.
- When the iPod/iPhone is disconnected from the unit during tagging, its tag information will be stored in the unit.

- If there is stored tag information on the unit, when an iPod/iPhone supporting the tag function is connected, the stored tag information will be transferred to the iPod/iPhone automatically. When the iPod/iPhone memory becomes full, “iPod Full” will be displayed, and any remaining tag information on the unit will not be transferred to the iPod/iPhone.
- If tag information already exists, “Already Tagged” will be displayed when you try to tag information again.

**Changing The Display**

Text information, such as the channel name, artist name/feature and song/program title, is available with each SiriusXM channel. The unit can display this text information as explained below.

In SiriusXM mode, press  VIEW.





Each time you press this button, the display changes as shown below.

Channel Number/Channel Name\* → Artist Name\*/  
Song Title\* → Content info.\*/Category Name\* → Clock  
→ Channel Number/Channel Name

\* If there is no text information, nothing will be displayed.

### About The Indication Display

When displaying Text, the following indicators are lit according to the mode.

Indicator/Mode	SiriusXM Mode
CH	Channel Number being displayed
CH:	Channel Name being displayed
	Artist Name being displayed
	Song Title being displayed
	Content INFO being displayed
CAT	Category Name being displayed

# ADDITIONAL INFORMATION

## CONTENTS

---

■ IN CASE OF DIFFICULTY. . . . .	.186	□ Flash Memory Messages. . . . .	.190
□ Basic . . . . .	.186	□ iPod Messages. . . . .	.192
□ Radio . . . . .	.186	□ Bluetooth Mode. . . . .	.192
□ CD. . . . .	.187	□ SiriusXM Advisory Messages . . . . .	.192
□ MP3/WMA/AAC . . . . .	.189	□ Pandora Mode Messages . . . . .	.195
□ Audio. . . . .	.189	□ Specifications . . . . .	.196
□ iPod. . . . .	.189	□ About The Rules Of Bluetooth Electromagnetic Radiation Regulation . . . . .	.199
□ CD Player Messages . . . . .	.189		

## IN CASE OF DIFFICULTY

If you encounter a problem, turn the power off, then on again. If the unit is still not functioning normally, review the items in the following checklist. This guide will help you isolate the problem if the unit is at fault. Otherwise, make sure the rest of your system is properly connected or consult your authorized dealer.

### Basic

#### No Function or Display.

- Vehicle's ignition is off.
  - If connected following instructions, the unit will not operate with the vehicle's ignition off.
- Improper power lead (Red) and battery lead (Yellow) connections.
  - Check power lead and battery lead connections.

- Blown fuse.
  - Check the fuse of the unit; replace with the proper value if necessary.
- Internal micro-computer malfunctioned due to interference noise etc.
  - Press the RESET switch with a ballpoint pen or other pointed article. For details, refer to "Initial System Start-Up" on page 22.

### Radio

#### Unable to receive stations.

- No antenna or open connection in cable.
  - Make sure the antenna is properly connected; replace the antenna or cable if necessary.

**Unable to tune stations in the seek mode.**

- You are in a weak signal area.
  - Make sure the tuner is in the DX mode.
- If the area you are in is a primary signal area, the antenna may not be grounded and connected properly.
  - Check your antenna connections; make sure the antenna is properly grounded at its mounting location.
- The antenna may not be the proper length.
  - Make sure the antenna is fully extended; if broken, replace the antenna with a new one.

**Broadcast in noisy.**

- The antenna is not the proper length.
  - Extend the antenna fully; replace it if it is broken.
- The antenna is poorly grounded.
  - Make sure the antenna is grounded properly at its mounting location.

**CD****CD Player not functioning.**

- Out of operating temperature range +50°C (+120°F) for CD.
  - Allow the vehicle's interior (or trunk) temperature to cool.

**CD playback sound is wavering.**

- Moisture condensation in the CD Module.
  - Allow enough time for the condensation to evaporate (about 1 hour).

**CD insertion not possible.**

- A CD is already in the CD player.
  - Eject the CD and remove it.

- The CD is being improperly inserted.
  - Make sure the CD is being inserted following instructions in the CD Player Operation section.

#### **Unable to fast forward or backward the CD.**

- The CD has been damaged.
  - Eject the CD and discard it; using a damaged CD in your unit can cause damage to the mechanism.

#### **CD playback sound skips due to vibration.**

- Improper mounting of the unit.
  - Securely re-mount the unit.
- The disc is very dirty.
  - Clean the disc.
- The disc has scratches.
  - Change the disc.

- The pick-up lens is dirty.
  - Do not use a commercially available lens cleaner disc. Consult your nearest authorized dealer.

#### **CD playback sound skips without vibration.**

- The disc is dirty or scratched.
  - Clean the disc; damaged disc should be replaced.

#### **Error displays (built-in CD player only).**

- Mechanical error.
  - Press . After the error indication disappears, insert the disc again. If the above-mentioned solution does not solve the problem, consult your nearest authorized dealer.

#### **CD-R/CD-RW playback not possible.**

- Close session (finalization) has not been performed.
  - Perform finalization and attempt playback again.

## MP3/WMA/AAC

**MP3, WMA or AAC is not played back.**

- Writing error occurred. The MP3/WMA/AAC format is not compatible.
  - Make sure the MP3/WMA/AAC has been written in a supported format. Refer to “About MP3/WMA/AAC” on page 44, then rewrite in the format supported by this device.

## Audio

**The sound is not output from the speakers.**

- There is no signal output from the internal amplifier.
  - Power IC is switched to “ON”.

## iPod

**iPod does not play and no sound is output.**

- The iPod has not been recognized.
  - Reset this unit and the iPod. Refer to “Initial System Start-Up” on page 24. To reset the iPod, refer to the Owner’s Manual of the iPod.

## CD Player Messages

### No Disc



- No CD is inserted.
  - Insert a CD.
- Although a disc is inserted, “No Disc” is displayed and the unit does not start to play or eject the disc.
  - Remove the disc by following these steps: Press the  button again for at least 2 seconds. If the disc still does not eject, consult your authorized dealer.

## Error

- Mechanism error.
  1. Press the  button and eject the CD.

If not ejecting, consult your authorized dealer.
  2. When the error indication remains after ejecting, press the  button again.

If the error indication still does not turn off after pressing the  button for a few times, consult your authorized dealer.
- When “Error” is displayed:

If the disc cannot be ejected by pressing , press the RESET switch (refer to “Initial System Start-Up” on page 24) and press  again. If the disc still cannot be ejected, consult your authorized dealer.

## Protect

- A copy-protected WMA file was played back.
  - You can only play back non-copy-protected files.

## Unsupported

- A sampling rate/bit rate not supported by the unit is used.
  - Use a sampling rate/bit rate that is supported by the unit.

## Flash Memory Messages

### Error-01

- Database error or decoder error.
  - You can solve the problem by switching the source.

**Error-02**

- Communication error or boot error, etc.
  - You can solve the problem by reconnecting the Flash Memory or format the USB Memory.

**Current Error**

- Abnormal current is run to the USB connector device.
  - You can solve the problem by switching the source.

**USB Device Error**

- A USB device that is not supported by the unit is connected.
  - Connect a USB device that is supported by the unit.

**No USB Unit**

- A Flash Memory is not connected.
  - Make sure the Flash Memory device is correctly connected and the cable is not excessively bent.

**No Song**

- No song (file) is stored in the Flash Memory.
  - Connect the Flash Memory device after storing songs (files).

**Unsupported**

- A sampling rate/bit rate not supported by the unit is used.
  - Use a sampling rate/bit rate that is supported by the unit.

**Protect**

- A copy-protected WMA file was played back.
  - You can only play back non-copy-protected files.



## iPod Messages

### No USB Unit

- The iPod/iPhone is not connected.
  - Make sure the iPod/iPhone is correctly connected (refer to “Connections” on page 148). Make sure the cable is not bent excessively.

### No Song

- There are no songs in the iPod/iPhone.
  - Download songs to the iPod/iPhone and connect to this unit.

### Error-01

- Communication error or boot error, etc.
  - You can solve the problem by reconnecting the iPod/iPhone or changing source.

### Error-02

- The iPod/iPhone version is too low.
  - Update the iPod/iPhone version.

### Error-03

- The iPod/iPhone is not verified.
  - You can solve the problem by reconnecting the iPod/iPhone.

## Bluetooth Mode

### No Unit

- The BLUETOOTH device is not connected.
  - Connect the BLUETOOTH device.

## SiriusXM Advisory Messages

The following messages may be displayed while operating the unit in SiriusXM mode.

### Check Tuner

- The SiriusXM tuner is disconnected or the unit is having trouble communicating with Tuner.
  - Connect the Tuner or check the Tuner connection to the back of the unit.

### Check Antenna

- The SiriusXM Satellite Radio antenna or cable is either damaged or not connected correctly to the SiriusXM Tuner.
  - Check that the SiriusXM antenna cable is connected to the SiriusXM Tuner and check that the antenna cable is not kinked or otherwise damaged. Replace the antenna if necessary.

### No Signal

- The SiriusXM satellite signal is too weak at the current location.
  - Move the vehicle to a location with a clear view of the southern sky.
  - Make sure the Satellite Radio antenna is properly mounted and not obstructed by metal objects.

### Channel Unsubscribed

- The active channel has become unsubscribed or the requested channel is not available in your subscription package.

#### NOTE:

- The unit will revert to the previous selected channel or to channel 1 automatically.
  - Visit [www.siriusxm.com](http://www.siriusxm.com) for information on subscribing to this channel.

### Channel Unavailable

- The active channel is no longer in the SiriusXM channel lineup or the user has entered an invalid channel number.

#### NOTE:

- The unit will revert to the previous channel or to channel 1 automatically.
  - Visit [www.siriusxm.com](http://www.siriusxm.com) for information on the current channel lineup.

### Subscription Updated → Press Any Key To Continue

- Your subscription has been updated.
  - Press any button to clear this message.

### Channel Locked

- A locked channel is selected.
  - Input the pass code. On how to input pass code, refer to “Setting the Parental Control” on page 172.

#### NOTE:

- If the wrong pass code is input, “Wrong Code” will be displayed and the unit will revert to the previous selected channel.

### Memory Short

- Buffer for Replay will full within 11 seconds.

### Memory Full

- Buffer for Replay is full.

## Pandora Mode Messages

### No Pandora

- A Smartphone is not connected.
  - Make sure a Smartphone is correctly connected.



### No Station

- You have not created any personalized Pandora Stations.
  - When you are not driving, use the Pandora Compatible Application on the Smartphone to create your Pandora station(s).

### See Device

- The music cannot be played because the Pandora Compatible Application on the Smartphone requires the user's attention.
  - When you are not driving, please see the Pandora Compatible Application on the Smartphone.

### No Service

- You switched CDE-HD149BT to Pandora mode by pressing  /SOURCE with a Smartphone connected, without launching or installing the Pandora Application.
  - Launch the Pandora Application on the Smartphone.
  - Select a source other than Pandora by pressing  /SOURCE.

**Specifications****FM TUNER SECTION**

Tuning Range	87.7~107.9 MHz
Mono Usable Sensitivity	9.3 dBf (0.8 $\mu$ V/75 ohms)
50 dB Quieting Sensitivity	13.5 dBf (1.3 $\mu$ V/75 ohms)
Alternate Channel Selectivity	80 dB
Signal-to-Noise Ratio	65 dB
Stereo Separation	35 dB
Capture Ratio	2.0 dB

**AM TUNER SECTION**

Tuning Range	530~1,710 kHz
Sensitivity (IEC Standard)	22.5 $\mu$ V/27 dB

**CD PLAYER SECTION**

Frequency Response	5~20,000 Hz ( $\pm$ 1 dB)
Wow & Flutter (% WRMS)	Below measurable limits
Total Harmonic Distortion	0.008% (at 1 kHz)
Dynamic Range	95 dB (at 1 kHz)
Signal-to-Noise Ratio	105 dB
Channel Separation	85 dB (at 1 kHz)

**PICKUP**

Wave length	795 nm
Laser power	CLASS I

## USB SECTION

USB requirements	USB 1.1/2.0
Max. Power Consumption	Smartphone charge-capable
USB Class	Mass Storage
File System	FAT 12/16/32
MP3 Decoding	MPEG AUDIO Layer-3
WMA Decoding	Windows Media Audio
AAC Decoding	AAC-LC format “.m4a” file

## BLUETOOTH SECTION

BLUETOOTH Specification	Bluetooth V2.1 + EDR
Output Power	+4 dBm Max. (Power class 2)
Profile	HFP (Hands-Free Profile) HSP (Head Set Profile) A2DP (Advanced Audio Distribution Profile) AVRCP (Audio/Video Remote Control Profile)

## GENERAL

Power Requirement	14.4 V DC (11~16 V allowable)
Power Output	18 W RMS × 4*

\* Primary amplifier ratings per CEA-2006 Standard

- Power output: measured at 4 Ohms and  $\leq 1\%$  THD+N
- S/N: 80 dBA (reference: 1 W into 4 Ohms)

Maximum Pre-Output Voltage	4V/10k ohms
Bass	$\pm 9.1$ dB at 100 Hz
Treble	$\pm 9.1$ dB at 10 kHz
Loudness	10 dB at 100 Hz
Weight	1.5 kg (3 lbs. 5 oz)

## CHASSIS SIZE

Width	178 mm (7")
Height	50 mm (2")
Depth	161.5 mm (6-3/8")

## NOSEPIECE SIZE

Width	168 mm (6-5/8")
Height	45 mm (1-3/4")
Depth	24 mm (1")

**NOTE:** Due to continuous product improvement, specifications and design are subject to change without notice.

## About The Rules Of Bluetooth Electromagnetic Radiation Regulation

### USA/Canada

#### FCC CAUTION

Changes or modifications not expressly approved by the party responsible for compliance could void the user's authority to operate the equipment. This device complies with Part 15 of FCC Rules and Industry Canada licence-exempt RSS standard(s). Operation is subject to the following two conditions: (1) this device may not cause interference, and (2) this device must accept any interference, including interference that may cause undesired operation of this device.

Le présent appareil est conforme aux la partie 15 des règles de la FCC et CNR d'Industrie Canada applicables aux appareils radio exempts de licence. L'exploitation est autorisée aux deux conditions suivantes : (1) l'appareil ne doit pas produire de brouillage, et (2) l'utilisateur de l'appareil doit accepter tout brouillage radioélectrique subi, même si le brouillage est susceptible d'en compromettre le fonctionnement.



**USA/Canada**

This equipment complies with FCC/IC radiation exposure limits set forth for an uncontrolled environment and meets the FCC radio frequency (RF) Exposure Guidelines in Supplement C to OET65 and RSS-102 of the IC radio frequency (RF) Exposure rules. This equipment has very low levels of RF energy that it deemed to comply without maximum permissive exposure evaluation (MPE). But it is desirable that it should be installed and operated keeping the radiator at least 20cm or more away from person's body (excluding extremities: hands, wrists, feet and ankles).

**USA/Canada**

Cet équipement est conforme aux limites d'exposition aux rayonnements énoncées pour un environnement non contrôlé et respecte les règles des radioélectriques (RF) de la FCC lignes directrices d'exposition dans le Supplément C à OET65 et d'exposition aux fréquences radioélectriques (RF) CNR-102 de l'IC. Cet équipement émet une énergie RF très faible qui est considérée conforme sans évaluation de l'exposition maximale autorisée. Cependant, cet équipement doit être installé et utilisé en gardant une distance de 20 cm ou plus entre le dispositif rayonnant et le corps (à l'exception des extrémités : mains, poignets, pieds et chevilles).

**México**

La operación de este equipo está sujeta a las siguientes dos condiciones: (1) es posible que este equipo o dispositivo no cause interferencia perjudicial y (2) este equipo o dispositivo debe aceptar cualquier interferencia, incluyendo la que pueda causar su operación no deseada.



**4C**

16ALFA-526-AA  
©2015 FCA US LLC. All Rights Reserved.  
ALFA ROMEO is a registered trademark of  
FCA Group Marketing S.p.A., used with permission.



First Edition  
Printed in U.S.A.