

2016 USER GUIDE

# RAM TRUCKS

1500/2500/3500



GUTS · GLORY



RAM



If you are the first registered retail owner of your vehicle, you may obtain a complimentary printed copy of the Owner's Manual, Navigation/Uconnect Manuals or Warranty Booklet by calling 1-866-726-4636 (U.S.) or 1-800-387-1143 (Canada) or by contacting your dealer.

## IMPORTANT

This User Guide is intended to familiarize you with the important features of your vehicle. The DVD enclosed contains your Owner's Manual, Navigation/Uconnect Manuals, Warranty Booklets, Tire Warranty and Roadside Assistance (new vehicles purchased in the U.S.) or Roadside Assistance (new vehicles purchased in Canada) in electronic format. We hope you find it useful. U.S. residents can purchase replacement DVD kits by visiting [www.techauthority.com](http://www.techauthority.com) and Canadian residents can purchase replacement DVD kits by calling 1-800-387-1143.

The driver's primary responsibility is the safe operation of the vehicle. Driving while distracted can result in loss of vehicle control, resulting in a collision and personal injury. FCA US LLC strongly recommends that the driver use extreme caution when using any device or feature that may take their attention off the road. Use of any electrical devices, such as cellular telephones, computers, portable radios, vehicle navigation or other devices, by the driver while the vehicle is moving is dangerous and could lead to a serious collision. Texting while driving is also dangerous and should never be done while the vehicle is moving. If you find yourself unable to devote your full attention to vehicle operation, pull off the road to a safe location and stop your vehicle. Some states or provinces prohibit the use of cellular telephones or texting while driving. It is always the driver's responsibility to comply with all local laws.

# TABLE OF CONTENTS

## INTRODUCTION/WELCOME

WELCOME FROM FCA US LLC	3
-------------------------	---

## CONTROLS AT A GLANCE

DRIVER COCKPIT	6
INSTRUMENT CLUSTER	8

## GETTING STARTED

KEY FOB	10
KEYLESS ENTER-N-GO	13
REMOTE START	15
VEHICLE SECURITY ALARM	15
SEAT BELT SYSTEMS	16
SUPPLEMENTAL RESTRAINT SYSTEM (SRS) — AIR BAGS	17
CHILD RESTRAINTS	21
HEAD RESTRAINTS	29
FRONT SEATS	31
HEATED/VENTILATED SEATS	37
HEATED STEERING WHEEL	39
TILT STEERING COLUMN	40
POWER FOLDING OUTSIDE MIRRORS FOR STANDARD AND TRAILER TOW	42

## OPERATING YOUR VEHICLE

ENGINE BREAK-IN RECOMMENDATIONS	43
TURN SIGNALS/WIPER/WASHER/HIGH BEAMS LEVER	44
HEADLIGHT SWITCH	45
ELECTRONIC SPEED CONTROL	46
EIGHT-SPEED AUTOMATIC TRANSMISSION — IF EQUIPPED	49
ELECTRONIC RANGE SELECT (ERS) OPERATION	50
1500 AIR SUSPENSION SYSTEM	51
REBEL AIR SUSPENSION SYSTEM	54
2500-3500 AIR SUSPENSION SYSTEM	56
STOP/START SYSTEM — IF EQUIPPED	58
MANUAL CLIMATE CONTROLS WITHOUT TOUCHSCREEN	61
MANUAL CLIMATE CONTROLS WITH TOUCHSCREEN	62
AUTOMATIC CLIMATE CONTROLS WITH TOUCHSCREEN	64
PARKSENSE FRONT AND REAR PARK ASSIST — IF EQUIPPED	66
PARKVIEW REAR BACK UP CAMERA — IF EQUIPPED	67
POWER SLIDING REAR WINDOW	69
POWER SUNROOF	69
WIND BUFFETING	71

## ELECTRONICS

YOUR VEHICLE'S SOUND SYSTEM	72
CYBERSECURITY	74
IDENTIFYING YOUR RADIO	75
UCONNECT ACCESS	77
RADIO 3.0	90
UCONNECT 3.0	92
UCONNECT 3.0 VOICE RECOGNITION QUICK TIPS	95
UCONNECT 5.0	99
UCONNECT 5.0 VOICE RECOGNITION QUICK TIPS	104
UCONNECT 8.4A/8.4AN	111
UCONNECT 8.4A/8.4AN VOICE RECOGNITION QUICK TIPS	125
UCONNECT PHONE	144
STEERING WHEEL AUDIO CONTROLS	155
ELECTRONIC VEHICLE INFORMATION CENTER (EVIC) OR DRIVER INFORMATION DISPLAY (DID)	155
PROGRAMMABLE FEATURES	156
UNIVERSAL GARAGE DOOR OPENER (HomeLink)	159
POWER INVERTER	162
POWER OUTLETS	163
AUXILIARY SWITCHES — IF EQUIPPED	165

## OFF-ROAD CAPABILITIES

ELECTRONICALLY SHIFTED FOUR WHEEL DRIVE OPERATION	166
---	-----

## UTILITY

TONNEAU COVER	169
EASY-OFF TAILGATE	169
PICKUP BOX	170
RAMBOX	172
TOWING & PAYLOAD	176
TOW/HAUL MODE	176
INTEGRATED TRAILER BRAKE MODULE	177
RECREATIONAL TOWING (BEHIND MOTORHOME, ETC.)	179

## 1500 3.0L DIESEL

DIESEL ENGINE BREAK-IN RECOMMENDATIONS	185
DIESEL ENGINE STARTING PROCEDURES	185
DIESEL FUEL FILTER/WATER SEPARATOR	187
EXHAUST REGENERATION	188
COOL-DOWN IDLE CHART	189
ADDING FUEL — DIESEL ENGINE ONLY	190
DIESEL EXHAUST FLUID	191

# TABLE OF CONTENTS

## 6.7L CUMMINS DIESEL

DIESEL ENGINE BREAK-IN RECOMMENDATIONS	195
DIESEL ENGINE STARTING PROCEDURES	195
DIESEL EXHAUST BRAKE (ENGINE BRAKING)	197
IDLE-UP FEATURE (AUTOMATIC TRANSMISSION ONLY)	198
ENGINE MOUNTED FUEL FILTER/WATER SEPARATOR	199
UNDERBODY MOUNTED FUEL FILTER/WATER SEPARATOR	200
EXHAUST REGENERATION	201
COOL-DOWN IDLE CHART	203
ADDING FUEL — DIESEL ENGINE ONLY	203
DIESEL EXHAUST FLUID	204

## WHAT TO DO IN EMERGENCIES

ROADSIDE ASSISTANCE	209
INSTRUMENT CLUSTER WARNING LIGHTS	209
INSTRUMENT CLUSTER INDICATOR LIGHTS	215
IF YOUR ENGINE OVERHEATS	216
JACKING AND TIRE CHANGING	217
JUMP-STARTING PROCEDURES	230
EMERGENCY TOW HOOKS	233
SHIFT LEVER OVERRIDE — 6-SPEED TRANSMISSION	234
MANUAL PARK RELEASE — 8 SPEED TRANSMISSION	236
TOWING A DISABLED VEHICLE	238
FREEDING A STUCK VEHICLE	238
ENHANCED ACCIDENT RESPONSE SYSTEM (EARS)	240
EVENT DATA RECORDER (EDR)	240

## MAINTAINING YOUR VEHICLE

TO OPEN AND CLOSE THE HOOD	241
ENGINE COMPARTMENT — 3.6L	242
ENGINE COMPARTMENT — 5.7L	244
ENGINE COMPARTMENT — 6.4L	246
ENGINE COMPARTMENT — 3.0L	

DIESEL	248
ENGINE COMPARTMENT — 6.7L DIESEL WITH 68RFE TRANSMISSION	250
ENGINE COMPARTMENT — 6.7L DIESEL WITH AS69RC TRANSMISSION	252
FLUID CAPACITIES — GAS ENGINE	254
FLUIDS, LUBRICANTS, AND GENUINE PARTS — GAS ENGINE	255
FLUID CAPACITIES — 1500 3.0L DIESEL	257
FLUIDS, LUBRICANTS, AND GENUINE PARTS — 1500 3.0L DIESEL	257
FLUID CAPACITIES — 6.7L CUMMINS DIESEL ENGINE	259
FLUIDS, LUBRICANTS, AND GENUINE PARTS — 6.7L CUMMINS DIESEL ENGINE	260
MAINTENANCE PROCEDURES	262
MAINTENANCE SCHEDULE — GASOLINE ENGINE	262
MAINTENANCE SCHEDULE — 1500 3.0L DIESEL ENGINE	267
MAINTENANCE SCHEDULE — 6.7L CUMMINS DIESEL ENGINE	273
FUSES	281
TIRES — GENERAL INFORMATION	285
REPLACEMENT BULBS	288

## CUSTOMER ASSISTANCE

FCA US LLC CUSTOMER CENTER	289
FCA CANADA INC. CUSTOMER CENTER	289
ASSISTANCE FOR THE HEARING IMPAIRED	289
PUBLICATIONS ORDERING	289
REPORTING SAFETY DEFECTS IN THE UNITED STATES	290

## MOPAR® ACCESSORIES

AUTHENTIC ACCESSORIES BY MOPAR	291
--------------------------------	-----

## FAQ's

FREQUENTLY ASKED QUESTIONS	292
----------------------------	-----

INDEX	294
-------	-----

# INTRODUCTION/WELCOME

## WELCOME FROM FCA US LLC

Congratulations on selecting your new FCA US LLC ("FCA US") vehicle. Be assured that it represents precision workmanship, distinctive styling, and high quality - all essentials that are traditional to our vehicles.

Your new FCA US vehicle has characteristics to enhance the driver's control under some driving conditions. These are to assist the driver and are never a substitute for attentive driving. They can never take the driver's place. Always drive carefully.

Your new vehicle has many features for the comfort and convenience of you and your passengers. Some of these should not be used when driving because they take your eyes from the road or your attention from driving. Never text while driving or take your eyes more than momentarily off the road.

This guide illustrates and describes the operation of features and equipment that are either standard or optional on this vehicle. This guide may also include a description of features and equipment that are no longer available or were not ordered on this vehicle. Please disregard any features and equipment described in this guide that are not available on this vehicle. FCA US reserves the right to make changes in design and specifications and/or make additions to or improvements to its products without imposing any obligation upon itself to install them on products previously manufactured.

This User Guide has been prepared to help you quickly become acquainted with the important features of your vehicle. It contains most things you will need to operate and maintain the vehicle, including emergency information.

The DVD includes a computer application containing detailed Owner's information which can be viewed on a personal computer or MAC computer. The multimedia DVD also includes videos which can be played on any standard DVD player (including the Uconnect Touchscreen Radios if equipped with DVD player capabilities). Additional DVD operational information is located on the back of the DVD sleeve.

**For complete owner information, refer to your Owner's Manual on the DVD in the owner's kit provided at the time of new vehicle purchase.** For your convenience, the information contained on the DVD may also be printed and saved for future reference.

FCA US is committed to protecting our environment and natural resources. By converting from paper to electronic delivery for the majority of the user information for your vehicle, together we greatly reduce the demand for tree-based products and lessen the stress on our environment.

# INTRODUCTION/WELCOME

## VEHICLES SOLD IN CANADA

With respect to any vehicles sold in Canada, the name FCA US LLC shall be deemed to be deleted and the name FCA Canada Inc. used in substitution (excluding legal lines).

### **WARNING!**

- Pedals that cannot move freely can cause loss of vehicle control and increase the risk of serious personal injury.
- Always make sure that objects cannot fall into the driver foot well while the vehicle is moving. Objects can become trapped under the brake pedal and accelerator pedal causing a loss of vehicle control.
- Failure to properly follow floor mat installation or mounting can cause interference with the brake pedal and accelerator pedal operation causing loss of control of the vehicle.
- Never leave children alone in a vehicle, or with access to an unlocked vehicle. Allowing children to be in a vehicle unattended is dangerous for a number of reasons. A child or others could be seriously or fatally injured. Children should be warned not to touch the parking brake, brake pedal or the transmission gear selector.
- Do not leave the key fob in or near the vehicle, or in a location accessible to children. A child could operate power windows, other controls, or move the vehicle.
- Never use the 'PARK' position as a substitute for the parking brake. Always apply the parking brake fully when parked to guard against vehicle movement and possible injury or damage.
- Refer to your Owner's Manual on the DVD for further details.

## USE OF AFTERMARKET PRODUCTS (ELECTRONICS)

The use of aftermarket devices including cell phones, MP3 players, GPS systems, or chargers may affect the performance of on-board wireless features including Keyless Enter-N-Go and Remote Start range. If you are experiencing difficulties with any of your wireless features, try disconnecting your aftermarket devices to see if the situation improves. If your symptoms persist, please see an authorized dealer.

When it comes to service, remember that your authorized dealer knows your vehicle best, has factory-trained technicians and genuine MOPAR® parts, and cares about your satisfaction.



# CONTROLS AT A GLANCE

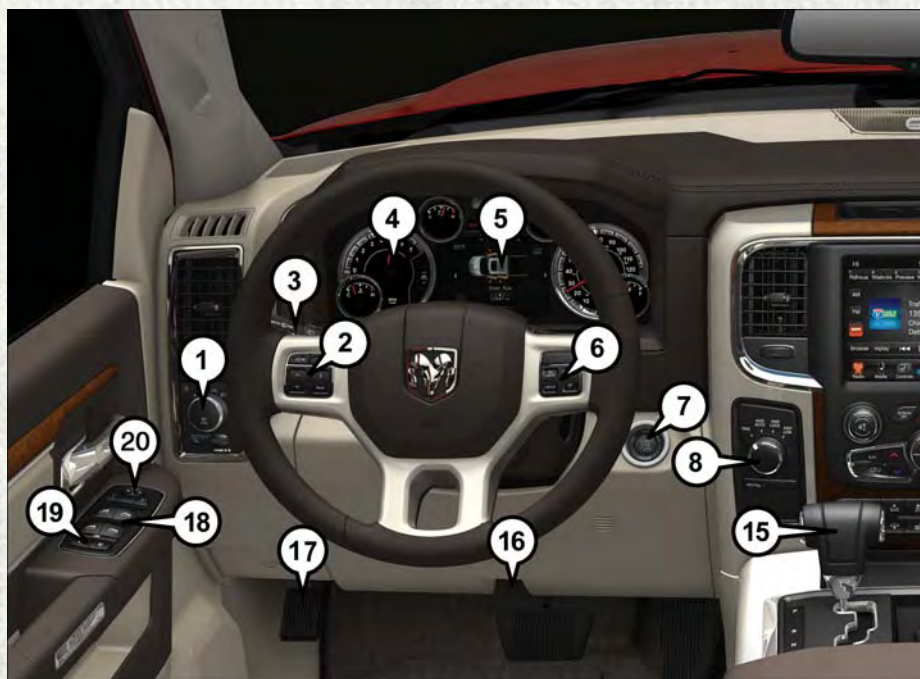

## DRIVER COCKPIT

1. Headlight Switch pg. 45
2. Electronic Vehicle Information Center (EVIC) Controls Or Driver Information Display (DID) Controls pg. 155
3. Turn Signal/Wiper/Washer/High Beams Lever pg. 44
4. Instrument Cluster pg. 8
5. Electronic Vehicle Information Center (EVIC) or Driver Information Display (DID) pg. 155
6. Electronic Speed Control pg. 46
7. Engine Starting/Stopping pg. 14
8. Four Wheel Drive Operation pg. 166
9. Uconnect Radio pg. 75
10. Climate Controls pg. 61



# CONTROLS AT A GLANCE

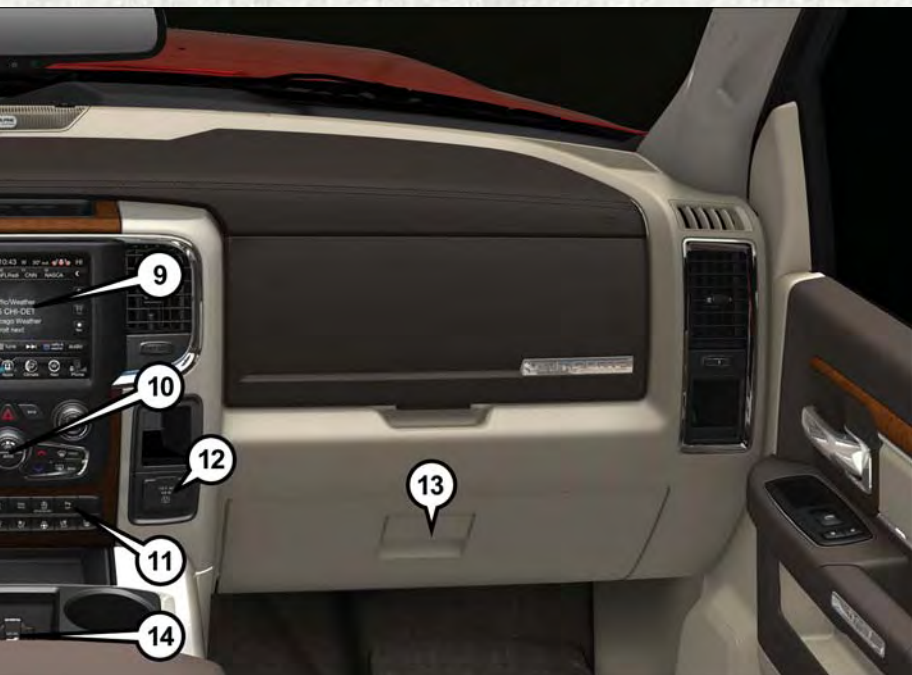

11. Switch Panel
12. Power Inverter Outlet pg. 162
13. Glove Compartment
14. Power Outlet
15. Shift Lever
16. Hood Release (below steering wheel at base of instrument panel) pg. 241
17. Parking Brake Release
18. Power Windows
19. Power Door Locks
20. Power Mirrors

# CONTROLS AT A GLANCE



## INSTRUMENT CLUSTER

1. Temperature Gauge
2. Tachometer
3. Voltmeter

(See page 209 for Instrument Cluster Warning Lights.)

# CONTROLS AT A GLANCE



4. Electronic Vehicle Information Center (EVIC) Or Driver Information Display (DID)
  5. Oil Pressure Gauge
  6. Speedometer
  7. Fuel Gauge
- (See page 215 for Instrument Cluster Indicator Lights.)

# GETTING STARTED

## KEY FOB

This feature allows the driver to operate the ignition switch with the push of a button, as long as the Remote Keyless Entry (RKE) transmitter is in the passenger compartment.

The Keyless Push Button Ignition has four operating positions, three of which are labeled and will illuminate when in position. The three positions are OFF, ACC, and ON/RUN. The fourth position is START, during start RUN will illuminate.



Key Fob

- 1 — Air Suspension
  - 2 — Unlock
  - 3 — Lock
  - 4 — Remote Start
  - 5 — Panic
-

**NOTE:**

In case the ignition switch does not change with the push of a button, the RKE transmitter (Key Fob) may have a low or dead battery. In this situation a back up method can be used to operate the ignition switch. Put the nose side (side opposite of the emergency key) of the Key Fob against the ENGINE START/STOP button and push to operate the ignition switch.

The Wireless Ignition Node (WIN) operates similar to an ignition switch. It has four operating positions, three with detents and one that is spring-loaded. The detent positions are OFF, ACC, and ON/RUN. The START position is a spring-loaded momentary contact position. When released from the START position, the switch automatically returns to the ON/RUN position.

## Locking And Unlocking The Doors

Push and release the UNLOCK button on the RKE transmitter once to unlock the driver's door. Push and release the UNLOCK button twice within five seconds to unlock all doors and the tailgate and the RamBox (if equipped). The turn signal lights will flash to acknowledge the unlock signal. The illuminated entry system will also turn on.

All doors can be programmed to unlock on the first push of the UNLOCK button. Refer to "Uconnect Customer Programmable Features" in "Electronics" for further information.

## Panic Alarm

1. Push the PANIC button once to turn the Panic Alarm on.
2. Wait approximately three seconds and push the button a second time to turn the Panic Alarm off.



- 1 — Lock
- 2 — Unlock
- 3 — Remote Start
- 4 — Emergency Key Release
- 5 — Emergency Key

# GETTING STARTED

## RKE Air Suspension (Remote Lowering Of Vehicle) — If Equipped



- This vehicle is equipped with a feature that can lower the vehicle to a height which will improve ease of passenger entry/exit and cargo loading/unloading. The feature is accessed by pushing the air suspension lowering button twice on the Key Fob.
- When remote Key Fob lowering is requested the vehicle will send a series of chirps and flashes to alert the customer that the operation has begun and will continue these alerts until it successfully lowers.
- If the feature is unable to lower the vehicle due to certain conditions not being met, the horn will chirp twice and the vehicle will not lower.

## Emergency Key

Should the battery in the vehicle or the Key Fob transmitter go dead, there is an emergency key located in the Key Fob that can be used for locking and unlocking the doors.

- To remove the emergency key, slide the button on the Key Fob with your thumb and then pull the key out with your other hand.

### WARNING!

- Never leave children alone in a vehicle, or with access to an unlocked vehicle. Allowing children to be in a vehicle unattended is dangerous for a number of reasons. A child or others could be severely injured or killed. Children should be warned not to touch the parking brake, brake pedal, or the transmission gear selector. Do not leave the Key Fob in or near the vehicle, or in a location accessible to children, and do not leave the ignition of a vehicle equipped with Keyless Enter-N-Go in the ACC or ON/RUN mode. A child could start the vehicle, operate power windows, other controls, or move the vehicle.
- Do not leave children or animals inside parked vehicles in hot weather. Interior heat build-up may cause them to be severely injured or killed.

## KEYLESS ENTER-N-GO

The Keyless Enter-N-Go system is an enhancement to the vehicle's Key Fob. This feature allows you to lock and unlock the vehicle's door(s) without having to push Key Fob lock or unlock buttons, as well as starting and stopping the vehicle with the push of a button.

### To Unlock From The Driver Or Passenger Side:

With a valid Keyless Enter-N-Go Key Fob located outside the vehicle and within 5 ft (1.5m) of the driver or passenger side door handle, grab either front door handle to unlock the door automatically.



Grab The Door Handle To Unlock

### To Lock The Vehicle's Doors:

With a valid Keyless Enter-N-Go Key Fob transmitter within 5 ft (1.5 m) of the driver or passenger front door handles, push door handle LOCK button to lock all doors.

Do NOT grab the door handle, when pushing the door handle lock button. This could unlock the door(s).



Push The Button To Lock



Do NOT Grab The Handle When Locking

#### NOTE:

- After pushing the door handle LOCK button, you must wait two seconds before you can lock or unlock the doors, using either Passive Entry door handle. This is done to allow you to check if the vehicle is locked by pulling the door handle without the vehicle reacting and unlocking.
- The Passive Entry system will not operate if the RKE transmitter battery is dead.

The vehicle doors can also be locked by using the RKE transmitter lock button or the lock button located on the vehicles interior door panel.

# GETTING STARTED

## Engine Starting/Stopping

### Starting

With a valid Keyless Enter-N-Go Key Fob inside the vehicle:

1. Shift the transmission into PARK.
2. While pushing the brake pedal, push the ENGINE START/STOP button once. If the engine fails to start, the starter will disengage automatically after 10 seconds.
3. To stop the cranking of the engine prior to the engine starting, push the button again.



Start/Stop Button

### NOTE:

In case the ignition switch does not change with the push of a button, the RKE transmitter (Key Fob) may have a low or dead battery. In this situation, a back up method can be used to operate the ignition switch. Put the nose side of the Key Fob (side opposite of the Emergency Key) against the ENGINE START/STOP button and push to operate the ignition switch.

### Stopping



1. Bring the vehicle to a complete stop.
2. Shift the transmission to PARK (P).
3. Push the ENGINE START/STOP button once. The ignition switch will return to the OFF position.

### NOTE:

If the transmission is not in PARK and the vehicle is in motion, the ENGINE START/STOP button must be held for two seconds with the vehicle speed above 5 mph (8 km/h) before the engine will shut off.



## REMOTE START

- Push REMOTE START button  on the Key Fob twice within five seconds. Pushing the REMOTE START  button a third time shuts the engine off.
- To drive the vehicle, push and release the UNLOCK button on the RKE transmitter to unlock the doors and disarm the Vehicle Security Alarm System (if equipped). Then cycle the ignition to the ON/RUN position.

With Remote Start, the engine will only run for 15 minutes (timeout) unless the ignition is cycled to the ON/RUN position.

The vehicle must be started with the Key Fob after two consecutive timeouts.

### WARNING!

- Do not start or run an engine in a closed garage or confined area. Exhaust gas contains Carbon Monoxide (CO) which is odorless and colorless. Carbon Monoxide is poisonous and can cause you or others to be severely injured or killed when inhaled.
- Keep Key Fob transmitters away from children. Operation of the Remote Start System, windows, door locks or other controls could cause you and others to be severely injured or killed.

## VEHICLE SECURITY ALARM

The Vehicle Security Alarm monitors the vehicle doors for unauthorized entry and the ignition for unauthorized operation. While the Vehicle Security Alarm is armed, interior switches for door locks and decklid release are disabled. If something triggers the alarm, the Vehicle Security Alarm will provide the following audible and visible signals: the horn will pulse, the park lamps and/or turn signals will flash, and the Vehicle Security Light in the instrument cluster will flash.

### To Arm The System:

Lock the door using either the power door lock switch (one door must be open) or the LOCK button on the Remote Keyless Entry (RKE) transmitter (doors can be open or closed), and close all doors.

The Vehicle Security Light in the instrument cluster will flash for 16 seconds. This shows that the Vehicle Security Alarm is arming. During this period, if a door is opened, the ignition is cycled to ON/RUN, or the power door locks are unlocked in any manner, the Vehicle Security Alarm will automatically disarm.

### NOTE:

- The Vehicle Security Alarm will not arm if you lock the doors with the manual door lock plungers.
- Once armed, the Vehicle Security Alarm disables the unlock switch on the driver door trim panel and passenger door trim panel.

# GETTING STARTED

## To Disarm The System:

Push the Key Fob UNLOCK button or cycle the ignition to the ON/RUN position.

The Vehicle Security Alarm is designed to protect your vehicle. However, you can create conditions where the Vehicle Security Alarm will give you a false alarm. If one of the previously described arming sequences has occurred, the Vehicle Security Alarm will arm regardless of whether you are in the vehicle or not. If you remain in the vehicle and open a door, the alarm will sound. If this occurs, disarm the Vehicle Security Alarm.

If the Vehicle Security Alarm is armed and the battery becomes disconnected, the Vehicle Security Alarm will remain armed when the battery is reconnected. The exterior lights will flash, and the horn will sound. If this occurs, disarm the Vehicle Security Alarm.

## SEAT BELT SYSTEMS

### Lap/Shoulder Belts

- All seating positions except the Quad Cab, Mega Cab and Crew Cab front center seating position have combination lap/shoulder belts.
- Be sure everyone in your vehicle is in a seat and using a seat belt properly.
- Position the lap belt so that it is snug and lies low across your hips, below your abdomen. To remove slack in the lap belt portion, pull up on the shoulder belt. To loosen the lap belt if it is too tight, tilt the latch plate and pull on the lap belt. A snug seat belt reduces the risk of sliding under the seat belt in a collision.
- Position the shoulder belt across the shoulder and chest with minimal, if any slack so that it is comfortable and not resting on your neck. The retractor will withdraw any slack in the shoulder belt.

### First Row Center Lap Belt Operating Instructions — If Equipped

The center seating position for the Quad Cab, Mega Cab and Crew Cab front seat has a lap belt only. To buckle the lap belt, slide the latch plate into the buckle until you hear a "click." To lengthen the lap belt, tilt the latch plate and pull. To remove slack, pull the loose end of the webbing. Wear the lap belt snug against the hips. Sit back and upright in the seat, then adjust the seat belt as tightly as is comfortable.

### Seat Belt Pretensioner

- The front seat belt system is equipped with pretensioning devices that are designed to remove slack from the seat belt in the event of a collision.
- A deployed pretensioner or a deployed air bag must be replaced immediately.

## WARNING!

- In a collision, you and your passengers can suffer much greater injuries if you are not properly buckled up. You can strike the interior of your vehicle or other passengers, or you can be thrown out of the vehicle. Always be sure you and others in your vehicle are buckled up properly.
- A shoulder belt placed behind you will not protect you from injury during a collision. You are more likely to hit your head in a collision if you do not wear your shoulder belt. The lap and shoulder belt are meant to be used together.
- A seat belt that is too loose will not protect you properly. In a sudden stop, you could move too far forward, increasing the possibility of injury. Wear your seat belt snugly.
- A frayed or torn seat belt could rip apart in a collision and leave you with no protection. Inspect the seat belt system periodically, checking for cuts, frays, or loose parts. Damaged parts must be replaced immediately. Do not disassemble or modify the system. Seat belt assemblies must be replaced after a collision.

## SUPPLEMENTAL RESTRAINT SYSTEM (SRS) — AIR BAGS

### Air Bag System Components

Your vehicle may be equipped with the following air bag system components:

- Occupant Restraint Controller (ORC)
- Air Bag Warning Light 
- Steering Wheel and Column
- Instrument Panel
- Knee Impact Bolsters
- Advanced Front Air Bags
- Supplemental Side Air Bags
- Front and Side Impact Sensors (if equipped)
- Seat Belt Pretensioners
- Seat Belt Buckle Switch

# GETTING STARTED

## Advanced Front Air Bags

- This vehicle has Advanced Front Air Bags for both the driver and front passenger as a supplement to the seat belt restraint systems. The Advanced Front Air Bags will not deploy in every type of collision.
- Advanced Front Air Bags are designed to provide additional protection by supplementing the seat belts. Advanced Front Air Bags are not expected to reduce the risk of injury in rear, side, or rollover collisions.
- The Advanced Front Air Bags will not deploy in all frontal collisions, including some that may produce substantial vehicle damage — for example, some pole collisions, truck underrides, and angle offset collisions.
- On the other hand, depending on the type and location of impact, Advanced Front Air Bags may deploy in crashes with little vehicle front-end damage but that produce a severe initial deceleration.
- Because air bag sensors measure vehicle deceleration over time, vehicle speed and damage by themselves are not good indicators of whether or not an air bag should have deployed.
- Seat belts are necessary for your protection in all collisions, and also are needed to help keep you in position, away from an inflating air bag.
- After any collision, the vehicle should be taken to an authorized dealer immediately.
- Do not drive your vehicle after the air bags have deployed. If you are involved in another collision, the air bags will not be in place to protect you.
- If it is necessary to modify the air bag system for persons with disabilities, contact your authorized dealer.
- Refer to the Owner's Manual on the DVD for further details regarding the Supplemental Restraint System (SRS).

### **WARNING!**

- Relying on the air bags alone could lead to more severe injuries in a collision. The air bags work with your seat belt to restrain you properly. In some collisions, the air bags won't deploy at all. Always wear your seat belts even though you have air bags.
- Being too close to the steering wheel or instrument panel during Advanced Front Air Bag deployment could cause serious injury, including death. Air bags need room to inflate. Sit back, comfortably extending your arms to reach the steering wheel or instrument panel.
- No objects should be placed over or near the air bag on the instrument panel or steering wheel because any such objects could cause harm if the vehicle is in a collision severe enough to cause the air bag to inflate.

## Supplemental Side Air Bags

- This vehicle is equipped with Supplemental Seat-Mounted Side Air Bags (SABs) located in the outboard side of the front seats. The SABs are marked with a SRS AIRBAG or AIRBAG label sewn into the outboard side of the seats.
- This vehicle is equipped with Supplemental Side Air Bag Inflatable Curtains (SABICs) located above the side windows. The trim covering the SABICs is labeled SRS AIRBAG or AIRBAG. The SABICs may help reduce the risk of partial or complete ejection of vehicle occupants through side windows in certain rollover or side impact events.
- The SABICs and SABs (“Side Air Bags”) are designed to activate in certain side impacts and certain rollover events. The Occupant Restraint Controller (“ORC”) determines whether the deployment of the Side Air Bags in a particular side impact or rollover event is appropriate, based on the severity and type of collision. Vehicle damage by itself is not a good indicator of whether or not Side Air Bags should have deployed.

### **WARNING!**

- Side Air Bags need room to inflate. Do not lean against the door or window. Sit upright in the center of the seat.
- Being too close to the Side Air Bags during deployment could cause you to be severely injured or killed.
- Relying on the Side Air Bags alone could lead to more severe injuries in a collision. The Side Air Bags work with your seat belt to restrain you properly. In some collisions, Side Air Bags won’t deploy at all. Always wear your seat belt even though you have Side Air Bags.
- This vehicle is equipped with left and right Supplemental Side Air Bag Inflatable Curtains (SABICs). Do not stack luggage or other cargo up high enough to block the deployment of the SABICs. The trim covering above the side windows where the SABIC and its deployment path are located should remain free from any obstructions.
- This vehicle is equipped with SABICs. In order for the SABICs to work as intended, do not install any accessory items in your vehicle which could alter the roof. Do not add an aftermarket sunroof to your vehicle. Do not add roof racks that require permanent attachments (bolts or screws) for installation on the vehicle roof. Do not drill into the roof of the vehicle for any reason.
- Do not use accessory seat covers or place objects between you and the Side Air Bags; the performance could be adversely affected and/or objects could be pushed into you, causing serious injury.

# GETTING STARTED

## Enhanced Accident Response System

In the event of an impact, if the communication network remains intact, and the power remains intact, depending on the nature of the event, the ORC will determine whether to have the Enhanced Accident Response System perform the following functions:

- Cut off fuel to the engine.
- Flash hazard lights as long as the battery has power or until the hazard light button is pushed. The hazard lights can be deactivated by pushing the hazard light button.
- Turn on the interior lights, which remain on as long as the battery has power.
- Unlock the power door locks.

## Enhanced Accident Response System Reset Procedure

In order to reset the Enhanced Accident Response System functions after an event, the ignition switch must be changed from ignition START or ON/RUN to ignition OFF. Carefully check the vehicle for fuel leaks in the engine compartment and on the ground near the engine compartment and fuel tank before resetting the system and starting the engine.

## Air Bag Warning Light

- The air bags must be ready to inflate for your protection in a collision. The Occupant Restraint Controller (ORC) monitors the internal circuits and interconnecting wiring associated with air bag system electrical components.
- The ORC monitors the readiness of the electronic parts of the air bag system whenever the ignition switch is in the START or ON/RUN position. If the ignition switch is in the OFF position or in the ACC position, the air bag system is not on and the air bags will not inflate.
- The ORC turns on the Air Bag Warning Light in the instrument panel for approximately four to eight seconds for a self-check when the ignition switch is first turned to the ON/RUN position. After the self-check, the Air Bag Warning Light will turn off. If the ORC detects a malfunction in any part of the system, it turns on the Air Bag Warning Light, either momentarily or continuously. A single chime will sound to alert you if the light comes on again after initial startup.
- If the Air Bag Warning Light in the instrument panel is not on during the four to eight seconds when the ignition switch is first turned to the ON/RUN position, stays on, or turns on while driving, have the vehicle serviced by an authorized service center immediately.

### NOTE:

If the speedometer, tachometer, or any engine related gauges are not working, the Occupant Restraint Controller (ORC) may also be disabled. In this condition the air bags may not be ready to inflate for your protection. Have an authorized dealer service the air bag system immediately.

## Event Data Recorder (EDR)

This vehicle is equipped with an event data recorder (EDR). The main purpose of an EDR is to record, in certain crash or near crash-like situations, such as an air bag deployment or hitting a road obstacle, data that will assist in understanding how a vehicle's systems performed. The EDR is designed to record data related to vehicle dynamics and safety systems for a short period of time, typically 30 seconds or less. The EDR in this vehicle is designed to record such data as:

- How various systems in your vehicle were operating;
- Whether or not the driver and passenger safety belts were buckled/fastened;
- How far (if at all) the driver was depressing the accelerator and/or brake pedal; and,
- How fast the vehicle was traveling.

These data can help provide a better understanding of the circumstances in which crashes and injuries occur.

### **NOTE:**

EDR data are recorded by your vehicle only if a non-trivial crash situation occurs; no data are recorded by the EDR under normal driving conditions and no personal data (e.g., name, gender, age, and crash location) are recorded. However, other parties, such as law enforcement, could combine the EDR data with the type of personally identifying data routinely acquired during a crash investigation.

To read data recorded by an EDR, special equipment is required, and access to the vehicle or the EDR is needed. In addition to the vehicle manufacturer, other parties, such as law enforcement, that have the special equipment, can read the information if they have access to the vehicle or the EDR.

## CHILD RESTRAINTS

Children 12 years or younger should ride properly buckled up in a rear seat, if available. According to crash statistics, children are safer when properly restrained in the rear seats rather than in the front.

Every state in the United States and all Canadian provinces require that small children ride in proper restraint systems. This is the law, and you can be prosecuted for ignoring it.

### **NOTE:**

- For additional information, refer to [www.Seatcheck.org](http://www.Seatcheck.org) or call: 1-866-732-8243
- Canadian residents should refer to Transport Canada's website for additional information:  
<http://www.tc.gc.ca/eng/motorvehiclesafety/safedrivers-childsafety-index-53.htm>

# GETTING STARTED

## **LATCH — Lower Anchors And Tethers For Children (Crew/Quad Cab Full Bench)**

- Your vehicle is equipped with the child restraint anchorage system called LATCH, which stands for Lower Anchors and Tethers for CHildren.
- The rear outboard seating positions have lower anchors and top tether anchors. The rear center seating position has a top tether anchor only.

## **LATCH – Lower Anchors And Tethers For Children (Crew/Mega/Quad Cab Split Bench)**

- Your vehicle is equipped with the child restraint anchorage system called LATCH, which stands for Lower Anchors and Tethers for CHildren.
- All rear seating positions have lower anchors and top tether anchors.

## **LATCH System Weight Limit**

You may use the LATCH anchorage system until the combined weight of the child and the child restraint is 65 lbs (29.5 kg). Use the seat belt and tether anchor instead of the LATCH system once the combined weight is more than 65 lbs (29.5 kg).

## **Locating LATCH Anchorages**

The lower anchorages are round bars that are found at the rear of the seat cushion where it meets the seatback. They are just visible when you lean into the rear seat to install the child restraint. You will easily feel them if you run your finger along the gap between the seatback and seat cushion.



**Lower Anchors**



## Locating Tether Anchorages

In addition, Regular Cab models have tether strap anchorages  behind the front center and right seats. Quad Cab, Mega Cab and Crew Cab models have tether strap anchorages located behind each of the rear seats.

## Center Seat LATCH (Regular/Quad/Crew Cab Full And Standard Bench)

Do not install a child restraint in the center position using the LATCH system. Use the seat belt and tether anchor to install a child seat in the center seating position.

## Center Seat LATCH (Mega/Quad/Crew Cab Split Bench)

If a child restraint installed in the center position blocks the seat belt webbing or buckle for the outboard position, do not use that outboard position. If a child seat in the center position blocks the outboard LATCH anchors or seat belt, do not install a child seat in that outboard position.

## Installing The Child Restraint Using The LATCH Lower Anchors

### NOTE:

Never “share” a LATCH anchorage with two or more child restraints.

1. Loosen the adjusters on the lower straps and on the tether strap of the child seat so that you can more easily attach the hooks or connectors to the vehicle anchorages.
2. Attach the lower hooks or connectors of the child restraint to the lower anchorages in the selected seating position.
3. If the child restraint has a tether strap, connect it to the top tether anchorage. See below for directions to attach a tether anchor.
4. Tighten all of the straps as you push the child restraint rearward and downward into the seat. Remove slack in the straps according to the child restraint manufacturer's instructions.
5. Test that the child restraint is installed tightly by pulling back and forth on the child seat at the belt path. It should not move more than 1 inch (25.4 mm) in any direction.

## Installing The Child Restraint Using The Vehicle Seat Belts (Regular Cab)

The seat belts in the passenger seating positions are equipped with a Switchable Automatic Locking Retractor (ALR) that is designed to keep the lap portion of the seat belt tight around the child restraint. Any seat belt system will loosen with time, so check the belt occasionally, and pull it tight if necessary.

# GETTING STARTED

## **Installing The Child Restraint Using The Vehicle Seat Belts (Mega/Quad/Crew Cab Full And Split Bench)**

The seat belts in the outboard passenger seating positions are equipped with a Switchable Automatic Locking Retractor (ALR). The center seating positions are equipped with a cinching latch plate. Both types of seat belts are designed to keep the lap portion of the seat belt tight around the child restraint. Any seat belt system will loosen with time, so check the belt occasionally, and pull it tight if necessary.

### **Tether Anchorage Weight Limit**

Always use the tether anchor when using the seat belt to install a forward facing child restraint, up to the recommended weight limit of the child restraint.

### **To Install A Child Seat Using An ALR:**

1. Pull enough of the seat belt webbing from the retractor to pass it through the belt path of the child restraint. Do not twist the belt webbing in the belt path.
2. Slide the latch plate into the buckle until you hear a “click.”
3. Pull on the webbing to make the lap portion tight against the child seat.
4. To lock the seat belt, pull down on the shoulder part of the belt until you have pulled all the seat belt webbing out of the retractor. Then, allow the webbing to retract back into the retractor. As the webbing retracts, you will hear a clicking sound. This means the seat belt is now in the Automatic Locking mode.
5. Try to pull the webbing out of the retractor. If it is locked, you should not be able to pull out any webbing. If the retractor is not locked, repeat the last step.
6. Finally, pull up on any extra webbing to tighten the lap portion around the child restraint while you push the child restraint rearward and downward into the vehicle seat.
7. If the child restraint has a top tether strap and the seating position has a top tether anchorage, connect the tether strap to the anchorage and tighten the tether strap. See below for directions to attach a tether anchor.
8. Test that the child restraint is installed tightly by pulling back and forth on the child seat at the belt path. It should not move more than 1 inch (25.4 mm) in any direction.

### **To Install A Child Seat Using A Cinching Latch Plate:**

1. Place the child seat in the center of the seating position.
2. Next, pull enough of the seat belt webbing from the retractor to pass it through the belt path of the child restraint. Do not twist the belt webbing in the belt path.
3. Slide the latch plate into the buckle until you hear a “click.”

4. Finally, pull up on any excess webbing to tighten the lap portion around the child restraint while you push the child restraint rearward and downward into the vehicle seat.
5. If the child restraint has a top tether strap and the seating position has a top tether anchorage, connect the tether strap to the anchorage and tighten the tether strap. See below for directions to attach a tether anchor.
6. Test that the child restraint is installed tightly by pulling back and forth on the child seat at the belt path. It should not move more than 1 inch (25.4 mm) in any direction.

## Installing The Top Tether Strap (With Either Lower Anchors Or Vehicle Seat Belt):

When installing a forward-facing child restraint, always secure the top tether strap, up to the tether anchor weight limit, whether the child restraint is installed with the lower anchors or the vehicle seat belt.

### Tether Strap Installation

#### Regular Cab Trucks:

In the regular cab truck, the top tether anchorages are located behind the center and right passenger seats. There is a plastic cover over each anchorage. To attach the tether strap of the child restraint:

#### Mega Cab Trucks:

In the regular cab truck, the top tether anchorages are located behind the center and right passenger seats. In the mega cab truck, the top tether anchorages are located behind each rear seating position. There is a plastic cover over each anchorage. To attach the tether strap of the child restraint:

1. Place the child restraint on the seat and adjust the tether strap so that it will reach over the seat back, under the head restraint and to the tether anchor directly behind the seat.
2. Route the tether strap to provide the most direct path between the anchorage and the child seat. The tether strap should go between the head restraint posts underneath the head restraint. You may need to adjust the head restraint to the upward position to pass the tether strap underneath the head restraint and between its posts.
3. Lift the cover (if equipped) and attach the hook to the square opening in the sheet metal. Tighten the tether strap according to the child seat manufacturer's instructions.

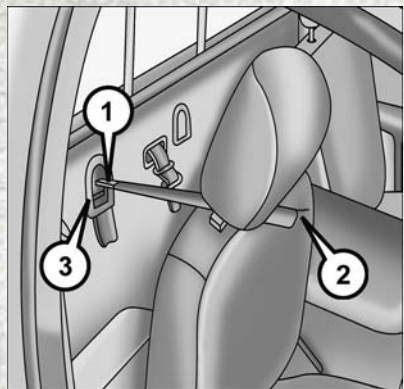

Regular Cab Tether Anchorages

# GETTING STARTED

## Quad/Crew Cab Trucks:

The top tether anchorages in this vehicle are tether strap loops located between the rear glass and the back of the rear seat. There is a tether strap loop located behind each seating position. Follow the steps below to attach the tether strap of the child restraint.

## Right or Left Outboard Seats:

1. Raise the head restraint and reach between the rear seat and rear glass to access the tether strap loop.

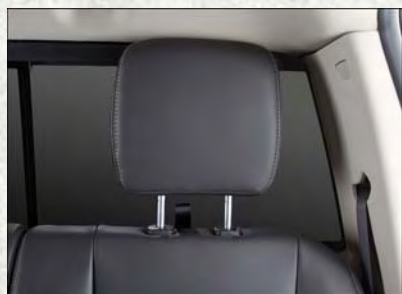

**Head Restraint In Raised Position**



**Tether Strap Loop With Center Head Restraint In Raised Position**

2. Place a child restraint on the seat and adjust the tether strap so that it will reach over the seat back, under the head restraint, through the tether strap loop behind the seat and over to the tether strap loop behind the center seat.
3. Pass the tether strap hook under the head restraint behind the child seat, through the tether strap loop behind the seat and over to the center tether strap loop.

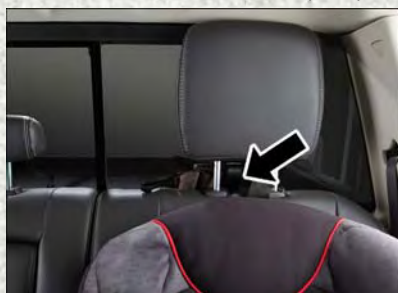

**Tether Strap Through Outboard Tether Strap Loop**

# GETTING STARTED

4. Attach the hook to the center tether strap loop (see diagram). Tighten the tether strap according to the child seat manufacturer's instructions.

**NOTE:**

If there are child seats in both of the outboard (left and right) seating positions, the tether strap hooks of both child seats should be connected to the center tether strap loop. This is the correct way to tether two outboard child seats.



**Tether Strap Through Outboard Tether Strap Loop And Attached To Center Tether Strap Loop**

**Center Seat:**

1. Raise the head restraint and reach between the rear seat and rear glass to access the tether strap loop.
2. Place a child restraint on the seat and adjust the tether strap so that it will reach over the seat back, under the head restraint, through the tether strap loop behind the seat and over to the tether strap loop behind either the right or left outboard seat.



**Tether Strap Loop With Head Restraint In Raised Position**

# GETTING STARTED

3. Pass the tether strap hook under the head restraint behind the child seat, through the tether strap loop behind the seat and over to the right or left outboard tether strap loop.
4. Attach the hook to the outboard tether strap loop (see diagram). Tighten the tether strap according to the child seat manufacturer's instructions.



**Tether Strap Through Center Tether Strap Loop**



**Tether Strap Through Center Tether Strap Loop And Attached To Outboard Tether Strap Loop**

## Installing Three Child Restraints:

1. Place a child restraint on each outboard rear seat. Route the tether straps following the directions for right and left seating positions, above.
2. Attach both hooks to the center tether strap loop, but do not tighten the straps yet.
3. Place a child restraint on the center rear seat. Route the tether strap following the directions for the center seating position, above.



**Left Outboard And Center Seating Position Shown**

4. Attach the hook to the outboard tether strap loop.
5. Tighten the tether straps according to the child seat manufacturer's instructions, tightening the right and left tether straps before the center tether strap.

## WARNING!

- In a collision, an unrestrained child, even a tiny baby, can become a projectile inside the vehicle. The force required to hold even an infant on your lap could become so great that you could not hold the child, no matter how strong you are. The child and others could be severely injured or killed. Any child riding in your vehicle should be in a proper restraint for the child's size.
- Never place a rear-facing child restraint in front of an air bag. A deploying Passenger Advanced Front Air Bag can cause death or serious injury to a child 12 years or younger, including a child in a rear-facing child restraint.
- Only use a rear-facing child restraint in a vehicle with a rear seat.
- Improper installation of a child restraint to the LATCH anchorages can lead to failure of an infant or child restraint. The child could be severely injured or killed. Follow the manufacturer's directions exactly when installing an infant or child restraint.
- An incorrectly anchored tether strap could lead to increased head motion and possible injury to the child. Use only the anchor positions directly behind the child seat to secure a child restraint top tether strap.
- If your vehicle is equipped with a split rear seat, make sure the tether strap does not slip into the opening between the seatbacks as you remove slack in the strap.

## HEAD RESTRAINTS

Head restraints are designed to reduce the risk of injury by restricting head movement in the event of a rear impact. Head restraints should be adjusted so that the top of the head restraint is located above the top of your ear.

## WARNING!

The head restraints for all occupants must be properly installed and adjusted prior to operating the vehicle or occupying a seat. Head restraints should never be adjusted while the vehicle is in motion. Driving a vehicle with the head restraints improperly adjusted or removed could cause serious injury or death in the event of a collision.

# GETTING STARTED

## Front Head Restraints

To raise the head restraint, pull upward on the head restraint. To lower the head restraint, push the adjustment button located on the base of the head restraint and push downward on the head restraint.

To remove the head restraint, raise it up as far as it can go then push the adjustment button and the release button at the base of each post while pulling the head restraint up. To reinstall the head restraint, put the head restraint posts into the holes then adjust it to the appropriate height.

### WARNING!

- A loose head restraint thrown forward in a collision or hard stop could cause serious injury or death to occupants of the vehicle. Always securely stow removed head restraints in a location outside the occupant compartment.
- ALL the head restraints MUST be reinstalled in the vehicle to properly protect the occupants. Follow the re-installation instructions above prior to operating the vehicle or occupying a seat.

### NOTE:

Do not reposition the head restraint 180 degrees to the incorrect position in an attempt to gain additional clearance to the back of the head.

## Rear Head Restraints

The rear seats are equipped with adjustable and removable head restraints. To raise the head restraint, pull upward on the head restraint. To lower the head restraint, push the adjustment button located on the base of the head restraint and push downward on the head restraint.

To remove the head restraint, push the adjustment button and the release button while pulling upward on the whole assembly. To reinstall the head restraint, put the head restraint posts into the holes and adjust it to the appropriate height.

### NOTE:

To remove outboard restraints, the rear seat bottom must be folded up.

### WARNING!

A loose head restraint thrown forward in a collision or hard stop could cause serious injury or death to occupants of the vehicle. Always securely stow removed head restraints in a location outside the occupant compartment.



## NOTE:

- The rear center head restraint (Crew Cab and Quad Cab) has only one adjustment position that is used to aid in the routing of a tether. Refer to "Occupant Restraints" in "Things to Know Before Starting Your Vehicle" in the Owner's Manual on the DVD.
- Do not reposition the head restraint 180 degrees to the incorrect position in an attempt to gain additional clearance to the back of the head.

## WARNING!

ALL the head restraints MUST be reinstalled in the vehicle to properly protect the occupants. Follow the re-installation instructions above prior to operating the vehicle or occupying a seat.

## FRONT SEATS

### Driver's Power Seat — If Equipped

Some models may be equipped with an eight-way power driver's seat. The power seat switches are located on the outboard side of the driver's seat cushion. There are two power seat switches that are used to control the movement of the seat cushion and the seatback.

#### Adjusting The Seat Forward Or Rearward

The seat can be adjusted both forward and rearward. Push the seat switch forward or rearward. The seat will move in the direction of the switch. Release the switch when the desired position has been reached.

#### Adjusting The Seat Up Or Down

The height of the seats can be adjusted up or down. Pull upward or push downward on the seat switch. The seat will move in the direction of the switch. Release the switch when the desired position is reached.

#### Tilting The Seat Up Or Down

The angle of the seat cushion can be adjusted in four directions. Pull upward or push downward on the front or rear of the seat switch, the front or rear of the seat cushion will move in the direction of the switch. Release the switch when the desired position is reached.



**Power Seat Switches**

- 1 — Power Seat Switch
- 2 — Recline Switch
- 3 — Power Lumbar Switch

# GETTING STARTED

## Reclining The Seatback

The angle of the seatback can be adjusted forward or rearward. Push the seatback switch forward or rearward, the seat will move in the direction of the switch. Release the switch when the desired position is reached.

### WARNING!

- Adjusting a seat while driving may be dangerous. Moving a seat while driving could result in loss of control which could cause a collision and serious injury or death.
- Seats should be adjusted before fastening the seat belts and while the vehicle is parked. Serious injury or death could result from a poorly adjusted seat belt.
- Do not ride with the seatback reclined so that the shoulder belt is no longer resting against your chest. In a collision you could slide under the seat belt, which could result in serious injury or death.

### CAUTION!

Do not place any article under a power seat or impede its ability to move as it may cause damage to the seat controls. Seat travel may become limited if movement is stopped by an obstruction in the seat's path.

## Passenger's Power Seat — If Equipped

Some models are equipped with a six-way power passenger seat. The power seat switch is located on the outboard side of the seat. The switch is used to control the movement of the seat and seat cushion.

## Power Lumbar — If Equipped

Vehicles equipped with power driver or passenger seats may be also be equipped with power lumbar. The power lumbar switch is located on the outboard side of the power seat. Push the switch forward to increase the lumbar support. Push the switch rearward to decrease the lumbar support.

## Driver Memory Seat — If Equipped

This feature allows the driver to store up to two different memory profiles for easy recall through a memory switch. Each memory profile contains desired position settings for the driver seat, side mirrors, adjustable pedals (if equipped) and a set of desired radio station presets. Your Remote Keyless Entry (RKE) transmitter can also be programmed to recall the same positions when the UNLOCK button is pushed.

### NOTE:

Your vehicle is equipped with two RKE transmitters, one RKE transmitter can be linked to memory position 1 and the other transmitter can be linked to memory position 2.

The memory seat buttons are located on the outboard side of the drivers seat cushion.

### Programming The Memory Feature

To create a new memory profile, perform the following:

1. Cycle the vehicles ignition to the ON/ RUN position (do not start the engine).
2. Adjust all memory profile settings to desired preferences (seat, side mirrors, adjustable pedals and radio station presets).
3. Push and release the S (Set) button on the memory switch.
4. Within five seconds, push and release either of the memory buttons (1) or (2). The Electronic Vehicle Information Center (EVIC) or Driver Information Display (DID) will display which memory position has been set.



**Memory Seat Button Location**

### NOTE:

- Memory profiles can be set without the vehicle in PARK, but the vehicle must be in PARK to recall a memory profile.
- To set a memory profile to your RKE transmitter, refer to “Linking And Unlinking The Remote Keyless Entry Transmitter To Memory” in this section.

# GETTING STARTED

## Linking And Unlinking The Remote Keyless Entry Transmitter To Memory

Your RKE transmitters can be programmed to recall one of two pre-programmed memory profiles by pushing the UNLOCK button on the RKE transmitter.

### NOTE:

Before programming your RKE transmitters to memory the feature has to be selected.

- If your vehicle is equipped with a touchscreen, you must select the “Memory To FOB” feature through the Uconnect system. Refer to “Uconnect Settings ” in “Understanding Your Instrument Panel” in the Owner’s Manual on the DVD for further information.
- If your vehicle is not equipped with a touchscreen, you must select the “Key Fob Linked To Memory” feature through the Electronic Vehicle Information Center (EVIC) or Driver Information Display (DID). Refer to “Electronic Vehicle Information Center (EVIC)” or “Driver Information Display (DID)” in “Understanding Your Instrument Panel” in the Owner’s Manual on the DVD for further information.

To program your RKE transmitters, perform the following:

1. Cycle the vehicles ignition to the Off position.
2. Select desired memory profile (1) or (2).

### NOTE:

If a memory profile has not already been set, refer to "Programming The Memory Feature" for instructions on how to set a memory profile.

3. Once the profile has been recalled, push and release the SET (S) button on the memory switch, then push and release button (1) or (2) accordingly. “Memory Profile Set” (1 or 2) will display in the instrument cluster on vehicles equipped with the EVIC/DID.
4. Push and release the LOCK button on the RKE transmitter within 10 seconds.

### NOTE:

Your RKE transmitters can be unlinked to your memory settings by pushing the SET (S) button, and within 10 seconds, followed by pushing the UNLOCK button on the RKE transmitter.

## Memory Position Recall

### NOTE:

- For vehicles equipped with an automatic transmission, the vehicle must be in PARK to recall memory positions. If a recall is attempted when the vehicle is not in PARK, a message will be displayed in the Electronic Vehicle Information Center (EVIC) or Driver Information Display (DID).
- For vehicles equipped with a manual transmission, the vehicle speed must be at 0 mph (0 km/h) to recall memory positions. If a recall is attempted with the vehicle speed above 0 mph (0 km/h), a message will display in the EVIC/DID.

## Driver One Memory Position Recall

- To recall the memory settings for driver one using the memory switch, push MEMORY button number 1 on the memory switch.
- To recall the memory settings for driver one using the RKE transmitter, push the UNLOCK button on the RKE transmitter linked to memory position 1.

## Driver Two Memory Position Recall

- To recall the memory setting for driver two using the memory switch, push MEMORY button number 2 on the memory switch.
- To recall the memory settings for driver two using the RKE transmitter, push the UNLOCK button on the RKE transmitter linked to memory position 2.

A recall can be cancelled by pushing any of the MEMORY buttons during a recall (S, 1, or 2). When a recall is cancelled, the driver's seat, and the power pedals (if equipped) stop moving. A delay of one second will occur before another recall can be selected.

## Easy Entry/Exit Seat

This feature provides automatic driver seat positioning to enhance driver mobility when entering and exiting the vehicle.

The distance the driver seat moves depends on where you have the driver seat positioned when you remove the Key Fob from the ignition (or change the ignition to OFF, for vehicles equipped with Keyless Enter-N-Go).

- When you remove the Key Fob from the ignition (or change the ignition to OFF, for vehicles equipped with Keyless Enter-N-Go), the driver seat will move about 2.4 inches (60 mm) rearward if the driver seat position is greater than or equal to 2.7 inches (67.7 mm) forward of the rear stop. The seat will return to its previously set position when you place the ignition into the ACC or RUN position.
- When you remove the Key Fob from the ignition (or change the ignition to OFF, for vehicles equipped with Keyless Enter-N-Go), the driver seat will move to a position 0.3 inches (7.7 mm) forward of the rear stop if the driver seat position is between 0.9 inches and 2.7 inches (22.7 mm and 67.7 mm) forward of the rear stop. The seat will return to its previously set position when you place the ignition to the ACC or RUN position.
- The Easy Entry/Easy Exit feature is disabled when the driver seat position is less than 0.9 inches (22.7 mm) forward of the rear stop. At this position, there is no benefit to the driver by moving the seat for Easy Exit or Easy Entry.

Each stored memory setting will have an associated Easy Entry and Easy Exit position.

### **NOTE:**

The Easy Entry/Exit feature is not enabled when the vehicle is delivered from the factory. The Easy Entry/Exit feature is enabled (or later disabled) through the programmable features in the Uconnect system. Refer to "Uconnect Settings/Customer Programmable Features" in "Understanding Your Instrument Panel" in the Owner's Manual on the DVD for further information.

# GETTING STARTED

## Manual Seat Adjuster — If Equipped

Both front seats are adjustable forward or rearward. The manual seat adjustment handle is located under the seat cushion at the front edge of each seat.

While sitting in the seat, pull up on the handle and slide the seat forward or backward. Release the bar once you have reached the desired position. Then, using body pressure, move forward and rearward on the seat to be sure that the seat adjusters have latched.



**Manual Seat Adjusting Bar/Recline Lever**

- 1 — Recline Lever
- 2 — Adjusting Bar

### **WARNING!**

- Adjusting a seat while driving may be dangerous. Moving a seat while driving could result in loss of control which could cause a collision and serious injury or death.
- Seats should be adjusted before fastening the seat belts and while the vehicle is parked. Serious injury or death could result from a poorly adjusted seat belt.

## **Dump Feature (Manual Recline Seat Only) — Standard Cab**

Actuating the recliner handle will allow the seatback to swing (dump) forward on manual recliner seats. This “dump” feature allows access to the storage bin behind the seat.

### **WARNING!**



- Do not stand or lean in front of the seat while actuating the handle. The seatback may swing forward and hit you causing injury.
- To avoid injury, place your hand on the seatback and actuate the handle, then position the seatback in the desired position.

## HEATED/VENTILATED SEATS

### Front Heated Seats

The front heated seats control buttons are located on the center instrument panel below the climate controls.

If your vehicle is equipped with a touchscreen, the front heated seats control buttons are also located within the climate or controls screen of the touchscreen.

- Press the heated seat button  once to turn the HI setting On.
- Press the heated seat button  a second time to turn the LO setting On.
- Press the heated seat button  a third time to turn the heating elements OFF.

When the HI-level setting is selected, the heater will provide a boosted heat level during the first four minutes of operation. Then, the heat output will drop to the normal HI-level. If the HI-level setting is selected, the system will automatically switch to LO-level after approximately 60 minutes of continuous operation. At that time, the display will change from HI to LO, indicating the change. The LO-level setting will turn OFF automatically after approximately 45 minutes.

#### NOTE:

The engine must be running for the heated seats to operate.

### Vehicles Equipped With Remote Start

On models that are equipped with Remote Start, the drivers seat can be programmed to come on during a remote start.



If your vehicle is equipped with a touchscreen, this feature can be programmed through the Uconnect system. Refer to “Uconnect Settings” in “Understanding Your Instrument Panel” in the Owner’s Manual on the DVD for further information.

If your vehicle is not equipped with a touchscreen, this feature can be programmed through the Electronic Vehicle Information Center (EVIC) or Driver Information Display (DID). Refer to “Electronic Vehicle Information Center (EVIC)” or “Driver Information Display (DID)” in “Understanding Your Instrument Panel” in the Owner’s Manual on the DVD for further information.

# GETTING STARTED

## Rear Heated Seats

The rear heated seat switches are located on the rear of the center console.

- Push the heated seat button  once to turn the HI setting On.
- Push the heated seat button  a second time to turn the LO setting On.
- Push the heated seat button  a third time to turn the heating elements OFF.

When the HI-level setting is selected, the heater will provide a boosted heat level during the first four minutes of operation. Then, the heat output will drop to the normal HI-level. If the HI-level setting is selected, the system will automatically switch to LO-level after a maximum of 60 minutes of continuous operation. At that time, the number of illuminated LEDs changes from two to one, indicating the change. The LO-level setting will turn OFF automatically after a maximum of 45 minutes.

### WARNING!



- Persons who are unable to feel pain to the skin because of advanced age, chronic illness, diabetes, spinal cord injury, medication, alcohol use, exhaustion or other physical conditions must exercise care when using the seat heater. It may cause burns even at low temperatures, especially if used for long periods of time.
- Do not place anything on the seat that insulates against heat, such as a blanket or cushion. This may cause the seat heater to overheat. Sitting in a seat that has been overheated could cause serious burns due to the increased surface temperature of the seat.

## Ventilated Seats — If Equipped

Located in the seat cushion are small fans that draw the air from the passenger compartment and move air through fine perforations in the seat cover to help keep the driver and front passenger cooler in higher ambient temperatures. The fans operate at two speeds, HI and LO.

The front ventilated seats control buttons are located on the center instrument panel below the climate controls.

If your vehicle is equipped with a touchscreen, the front ventilated seats control buttons are also located within the climate or controls screen of the touchscreen.

- Press the ventilated seat button  once to choose HI.
- Press the ventilated seat button  a second time to choose LO.
- Press the ventilated seat button  a third time to turn the ventilated seat OFF.

### NOTE:

The engine must be running for the ventilated seats to operate.



## Vehicles Equipped With Remote Start

On models that are equipped with remote start, the ventilated seats can be programmed to come on during a remote start.

If your vehicle is equipped with a touchscreen, this feature can be programmed through the Uconnect system. Refer to “Uconnect Settings” in “Understanding Your Instrument Panel” in the Owner’s Manual on the DVD for further information.



If your vehicle is not equipped with a touchscreen, this feature can be programmed through the Electronic Vehicle Information Center (EVIC) or Driver Information Display (DID). Refer to “Electronic Vehicle Information Center (EVIC)” or “Driver Information Display (DID)” in “Understanding Your Instrument Panel” in the Owner’s Manual on the DVD for further information.

## HEATED STEERING WHEEL

The steering wheel contains a heating element that helps warm your hands in cold weather. The heated steering wheel has only one temperature setting. Once the heated steering wheel has been turned on it will operate for approximately 30 to 80 minutes before automatically shutting off. The heated steering wheel can shut off early or may not turn on when the steering wheel is already warm.

The heated steering wheel control button is located on the center of the instrument panel below the climate controls.

If your vehicle is equipped with a touchscreen, the heated steering wheel control button is located within the climate or controls screen of the touchscreen.

- Press the heated steering wheel button  once to turn the heating element On.
- Press the heated steering wheel button  a second time to turn the heating element Off.

### NOTE:

The engine must be running for the heated steering wheel to operate.

## Vehicles Equipped With Remote Start

On models that are equipped with remote start, the heated steering wheel can be programmed to come on during a remote start.

If your vehicle is equipped with a touchscreen, this feature can be programmed through the Uconnect system. Refer to “Uconnect Settings” in “Understanding Your Instrument Panel” in the Owner’s Manual on the DVD for further information.

If your vehicle is not equipped with a touchscreen, this feature can be programmed through the Electronic Vehicle Information Center (EVIC) or Driver Information Display (DID). Refer to “Electronic Vehicle Information Center (EVIC)” or “Driver Information Display (DID)” in “Understanding Your Instrument Panel” in the Owner’s Manual on the DVD for further information.

# GETTING STARTED

## WARNING!

- Persons who are unable to feel pain to the skin because of advanced age, chronic illness, diabetes, spinal cord injury, medication, alcohol use, exhaustion, or other physical conditions must exercise care when using the steering wheel heater. It may cause burns even at low temperatures, especially if used for long periods.
- Do not place anything on the steering wheel that insulates against heat, such as a blanket or steering wheel covers of any type and material. This may cause the steering wheel heater to overheat.

## TILT STEERING COLUMN

This feature allows you to tilt the steering column upward or downward. The tilt lever is located on the steering column, below the multifunction lever.

Pull the lever toward the steering wheel to unlock the steering column. With one hand firmly on the steering wheel, move the steering column up or down, as desired. Release the lever to lock the steering column firmly in place.



**Tilt Lever Location**

- 1 — Adjustable Pedal Switch  
2 — Tilt Lever

## WARNING!

Do not adjust the steering column while driving. Adjusting the steering column while driving or driving with the steering column unlocked, could cause the driver to lose control of the vehicle. Failure to follow this warning may result in serious injury or death.

## DRIVER ADJUSTABLE PEDALS — IF EQUIPPED

The adjustable pedals system is designed to allow a greater range of driver comfort for steering wheel tilt and seat position. This feature allows the brake, accelerator, and clutch pedals (if equipped) to move toward or away from the driver to provide improved position with the steering wheel.

The adjustable pedal switch is located to the left side of the steering column.

- The pedals can be adjusted with the ignition OFF.
- The pedals **cannot** be adjusted when the vehicle is in REVERSE or when the Electronic Speed Control System is on. The following messages will be displayed on vehicles equipped with the Electronic Vehicle Information System (EVIC) or Driver Information Display (DID) if the pedals are attempted to be adjusted when the system is locked out (“Adjustable Pedal Disabled — Cruise Control Engaged” or “Adjustable Pedal Disabled — Vehicle In Reverse”).

### NOTE:

- Always adjust the pedals to a position that allows full pedal travel.
- Further small adjustments may be necessary to find the best possible seat/pedal position.
- For vehicles equipped with Driver Memory Seat, you can use your Remote Keyless Entry (RKE) transmitter or the memory switch on the driver’s door trim panel to return the adjustable pedals to pre-programmed positions. Refer to “Front Seats” in “Getting Started” for further information.

### CAUTION!

Do not place any article under the adjustable pedals or impede its ability to move as it may cause damage to the pedal controls. Pedal travel may become limited if movement is stopped by an obstruction in the adjustable pedal's path.

### WARNING!

Do not adjust the pedals while the vehicle is moving. You could lose control and have an accident. Always adjust the pedals while the vehicle is parked.

# GETTING STARTED

## POWER FOLDING OUTSIDE MIRRORS FOR STANDARD AND TRAILER TOW

If equipped with power folding mirrors, they can be electrically folded rearward and unfolded into the drive position.

The switch for the power folding mirrors is located between the power mirror switches L (left) and R (right). Push the switch once and the mirrors will fold in, push the switch a second time and the mirrors will return to the normal driving position.

If the mirror is manually folded after electrically cycled, a potential extra button push is required to get the mirrors back to the home position. If the mirror does not electrically fold check for ice or dirt build up at the pivot area which can cause excessive drag.

### Resetting the Power Folding Outside Mirrors

You may need to reset the power folding mirrors if the following occurs:

- The mirrors are accidentally blocked while folding.
- The mirrors are accidentally manually folded/unfolded.
- The mirrors come out of the unfolded position.
- The mirrors shake and vibrate at normal driving speeds.

To reset the power folding mirrors: Fold and unfold them by pushing the button (this may require multiple button pushes). This resets them to their normal position.

#### NOTE:

- The power fold mirrors are designed to operate while the vehicle is stationary or traveling at moderate speeds. If you attempt to power fold the mirrors at high speeds they may not fully open or close. You should slow down to a moderate speed and complete the operation.
- When pushing the power fold button 10 or more times in one minute the system shuts down for one minute to protect the motors from over heating.



Power Folding Mirror Switch

# OPERATING YOUR VEHICLE

## ENGINE BREAK-IN RECOMMENDATIONS

A long break-in period is not required for the engine and drivetrain (transmission and axle) in your vehicle.

Drive moderately during the first 300 miles (500 km). After the initial 60 miles (100 km), speeds up to 50 or 55 mph (80 or 90 km/h) are desirable.

While cruising, brief full-throttle acceleration within the limits of local traffic laws contributes to a good break-in. Wide-open throttle acceleration in low gear can be detrimental and should be avoided.

The engine oil installed in the engine at the factory is a high-quality energy conserving type lubricant. Oil changes should be consistent with anticipated climate conditions under which vehicle operations will occur. Refer to "Maintaining Your Vehicle," for the recommended viscosity and quality grades.

### NOTE:

A new engine may consume some oil during its first few thousand miles (kilometers) of operation. This should be considered a normal part of the break-in and not interpreted as an indication of an engine problem or malfunction.

### CAUTION!

Never use Non-Detergent Oil or Straight Mineral Oil in the engine or damage may result.

## Diesel Engine Break-In Recommendations

- For 3.0L diesel engine break-in recommendations, refer to Diesel Engine Break-In Recommendations on pg. 185
- For 6.7L Cummins diesel engine break-in recommendations, refer to Diesel Engine Break-In Recommendations on pg. 195

# OPERATING YOUR VEHICLE

## TURN SIGNALS/WIPER/WASHER/HIGH BEAMS LEVER



Turn Signal/Wiper/Washer/High Beam Lever

### Turn Signals/Lane Change Assist

Tap the lever up or down once and the turn signal (right or left) will flash three times and automatically turn off.

### Wipers

#### Intermittent, Low And High Operation

- Rotate the end of the lever to the first detent position for one of five intermittent settings, the second detent for low wiper operation and the third detent for high wiper operation.

#### Washer Operation

- Push the end of the lever inward to the second detent and hold for as long as spray is desired.

#### Mist Feature

- When a single wipe to clear off road mist or spray from a passing vehicle is needed, push the washer knob, located on the end of the multifunction lever, inward to the first detent and release. The wipers will cycle one time and automatically shut off.

### High Beams

- Push the lever away from you to activate the high beams.

A high beam symbol will illuminate in the cluster to indicate the high beams are on.

#### NOTE:

For safe driving, turn off the high beams when oncoming traffic is present to prevent headlight glare and as a courtesy to other motorists.



# OPERATING YOUR VEHICLE

## HEADLIGHT SWITCH

### NOTE:

If your vehicle is equipped with illuminated approach lights under the outside mirrors, they can be turned off through the instrument cluster or the Uconnect radio. For further information, refer to the Owner's Manual on the DVD.

### Automatic Headlights/Parking Lights/Headlights

- Rotate the headlight switch, located on the instrument panel to the left of the steering wheel, to the first detent  for parking lights and to the second detent for headlights .
- With the parking lights or low beam headlights on, push the headlight switch once for fog lights.
- Rotate the headlight switch to AUTO for Automatic headlights.
- When set to AUTO, the system automatically turns the headlights on or off based on ambient light levels.

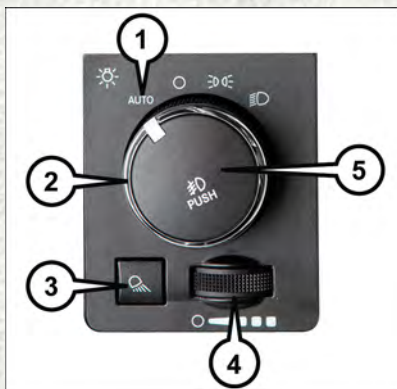

Headlight Switch

- 1 — Auto
- 2 — Rotate Headlight Switch
- 3 — Push Cargo Light
- 4 — Rotate Dimmer
- 5 — Push Fog Light

### Automatic High Beams

The Automatic High Beams system provides increased forward lighting at night by automating high beam control through the use of a digital camera mounted above the inside rearview mirror. This camera detects vehicle specific light and automatically switches from high beams to low beams until the approaching vehicle is out of view. This feature is programmable through the Uconnect system. Refer to "Uconnect Settings" in "Understanding Your Instrument Panel" in the Owner's Manual on the DVD for further details.

### Instrument Panel Dimmer

- Rotate the dimmer control to the extreme left position to fully dim the instrument panel lights and prevent the interior lights from illuminating when a door is opened.
- Rotate the dimmer control right to increase the brightness of the instrument panel when the parking lights or headlights are on.
- Rotate the dimmer control right to the next detent position to fully brighten the odometer and radio when the parking lights or headlights are on.

# OPERATING YOUR VEHICLE

- Rotate the dimmer control right to the last detent position to turn on the interior lighting.
- If your vehicle is equipped with a touchscreen, the dimming is programmable through the Uconnect system. Refer to “Uconnect Settings” in “Understanding Your Instrument Panel” in the Owner’s Manual on the DVD for further details.

## Cargo Light With Bed Lights — If Equipped

The cargo light and bed lights (if equipped) are turned on by pushing on the cargo lights button.

The cargo light and bed lights (if equipped) will also turn on for approximately 60 seconds when a RKE transmitter UNLOCK button is pushed, as part of the Illuminated Entry feature.

## ELECTRONIC SPEED CONTROL

When engaged, the Electronic Speed Control takes over accelerator operations at speeds greater than 25 mph (40 km/h).

The Electronic Speed Control buttons are located on the right side of the steering wheel.

### NOTE:

In order to ensure proper operation, the Electronic Speed Control System has been designed to shut down if multiple Speed Control functions are operated at the same time. If this occurs, the Electronic Speed Control System can be re-activated by pushing the Electronic Speed Control ON/OFF button and resetting the desired vehicle set speed.

## To Activate

Push the ON/OFF button. The Cruise Indicator Light in the instrument cluster will illuminate. To turn the system off, push the ON/OFF button a second time. The Cruise Indicator Light will turn off. The system should be turned off when not in use.



**Electronic Speed Control Buttons**

- 1 — Push Cancel
- 2 — Push On/Off
- 3 — Push Resume/Accel
- 4 — Push Set/Decel



## WARNING!

Leaving the Electronic Speed Control system on when not in use is dangerous. You could accidentally set the system or cause it to go faster than you want. You could lose control and have an accident. Always leave the system OFF when you are not using it.

### To Set A Desired Speed

Turn the Electronic Speed Control ON. When the vehicle has reached the desired speed, push the SET (-) button and release. Release the accelerator and the vehicle will operate at the selected speed.

#### NOTE:

The vehicle should be traveling at a steady speed and on level ground before pushing the SET (-) button.

### To Deactivate

A soft tap on the brake pedal, pushing the CANCEL button, or normal brake pressure while slowing the vehicle will deactivate the Electronic Speed Control without erasing the set speed from memory.

Pushing the ON/OFF button or turning the ignition switch OFF erases the set speed from memory.

### To Resume Speed

To resume a previously set speed, push the RES (+) button and release. Resume can be used at any speed above 20 mph (32 km/h).

### To Vary The Speed Setting

#### To Increase Speed

When the Electronic Speed Control is set, you can increase speed by pushing the RES (+) button.

The drivers preferred units can be selected through the instrument panel settings if equipped. Refer to "Understanding Your Instrument Panel" in the Owner's Manual on the DVD for more information. The speed increment shown is dependant on the chosen speed unit of U.S. (mph) or Metric (km/h):

#### U.S. Speed (mph)

- Pushing the RES (+) button once will result in a 1 mph increase in set speed. Each subsequent tap of the button results in an increase of 1 mph.
- If the button is continually pushed, the set speed will continue to increase until the button is released, then the new set speed will be established.

# OPERATING YOUR VEHICLE

## Metric Speed (km/h)

- Pushing the RES (+) button once will result in a 1 km/h increase in set speed. Each subsequent tap of the button results in an increase of 1 km/h.
- If the button is continually pushed, the set speed will continue to increase until the button is released, then the new set speed will be established.

## To Decrease Speed

When the Electronic Speed Control is set, you can decrease speed by pushing the SET (-) button.

The drivers preferred units can be selected through the instrument panel settings if equipped. Refer to “Understanding Your Instrument Panel” in the Owner’s Manual on the DVD for more information. The speed increment shown is dependant on the chosen speed unit of U.S. (mph) or Metric (km/h):

## U.S. Speed (mph)

- Pushing the SET (-) button once will result in a 1 mph decrease in set speed. Each subsequent tap of the button results in a decrease of 1 mph.
- If the button is continually pushed, the set speed will continue to decrease until the button is released, then the new set speed will be established.

## Metric Speed (km/h)

- Pushing the SET (-) button once will result in a 1 km/h decrease in set speed. Each subsequent tap of the button results in a decrease of 1 km/h.
- If the button is continually pushed, the set speed will continue to decrease until the button is released, then the new set speed will be established.

## To Accelerate For Passing

Press the accelerator as you would normally. When the pedal is released, the vehicle will return to the set speed.

## Using Electronic Speed Control On Hills

The transmission may downshift on hills to maintain the vehicle set speed.

### **NOTE:**

The Electronic Speed Control system maintains speed up and down hills. A slight speed change on moderate hills is normal.

On steep hills, a greater speed loss or gain may occur so it may be preferable to drive without Electronic Speed Control.

# OPERATING YOUR VEHICLE

## WARNING!

Electronic Speed Control can be dangerous where the system cannot maintain a constant speed. Your vehicle could go too fast for the conditions, and you could lose control and have an accident. Do not use Electronic Speed Control in heavy traffic or on roads that are winding, icy, snow-covered or slippery.

## EIGHT-SPEED AUTOMATIC TRANSMISSION — IF EQUIPPED

Your vehicle may be equipped with a fuel efficient eight-speed transmission. The electronic transmission gear selector is located on the instrument panel. The transmission gear (PRND) is displayed both above the shifter control and in the Electronic Vehicle Information Center (EVIC)/Driver Information Display (DID).

- To select a gear range, simply rotate the gear selector.

### NOTE:

You must press the brake pedal to shift the transmission out of PARK or from NEUTRAL into DRIVE or REVERSE.

- To shift past multiple gear ranges at once (such as PARK to DRIVE), simply rotate the switch to the appropriate detent.
- Select the DRIVE range for normal driving.



Rotary Gear Selector

# OPERATING YOUR VEHICLE

## ELECTRONIC RANGE SELECT (ERS) OPERATION

Electronic Range Select (ERS) allows you to limit the highest available transmission gear, and can be activated during any driving condition. When towing a trailer or operating the vehicle in off-road conditions, using ERS shift control will help you maximize both performance and engine braking.

- Toggle the switch on the column shift lever down (-) or up (+) to select the desired top gear.
- For maximum deceleration (engine braking) toggle the switch on the column shift lever down (-) and hold. Your vehicle will automatically select the lowest safe gear for optimal engine braking.
- To disable ERS, push and hold the column shift lever switch up (+) until "D" is displayed in the odometer.



**ERS Control On The Shift Lever**

Switching between ERS and DRIVE mode can be done at any vehicle speed. Refer to your Owner's Manual on the DVD for further details.

# OPERATING YOUR VEHICLE

## Electronic Range Select (ERS) Operation — Eight-Speed Transmission

The Electronic Range Select (ERS) shift control allows the driver to limit the highest available gear when the transmission shifter switch is in the DRIVE position

You can switch between DRIVE and ERS mode at any vehicle speed.

- Tapping the ERS (-) switch (on the steering wheel) will activate ERS mode.
- Once in ERS mode, tapping the ERS (-) or (+) switch will change the top available gear.
- To exit ERS mode, simply push and hold the ERS (+) switch until “D” is once again displayed in the transmission gear position indicator in the instrument cluster.



ERS Control

## 1500 AIR SUSPENSION SYSTEM

The air suspension system provides full time load leveling capability along with the benefit of being able to adjust vehicle height by the push of a button.

Automatic height changes will occur based on vehicle speed and the current vehicle height. The indicator lamps and EVIC/DID messages will operate the same for automatic changes and user requested changes.

### Description

**Normal Ride Height (NRH)** - This is the standard position of the suspension and is meant for normal driving.

**Off-Road 1 (OR1) (Raises the vehicle approximately 1 in (26 mm))** - This position should be the primary position for all off-road driving until Off Road 2 (OR2) is needed. A smoother and more comfortable ride will result. To enter OR1, push the “Up” button once from the NRH



1500 Air Suspension Controls

- 1 — Off-Road 1 Indicator
- 2 — Off-Road 2 Indicator
- 3 — Up Button
- 4 — Down Button
- 5 — Entry/Exit Mode Indicator
- 6 — Normal Ride Height Indicator

# OPERATING YOUR VEHICLE

position while the vehicle speed is below 35 mph (56 km/h). When in the OR1 position, if the vehicle speed remains between 40 mph (64 km/h) and 50 mph (80 km/h) for greater than 20 seconds or if the vehicle speed exceeds 50 mph (80 km/h), the vehicle will be automatically lowered to NRH. Off-Road 1 may not be available due to vehicle payload, an EVIC/DID message will be displayed when this occurs. Refer to “Electronic Vehicle Information Center (EVIC)/Driver Information Display (DID)” in “Understanding Your Instrument Panel” in the Owner’s Manual on the DVD for further information.

**Off-Road 2 (OR2) (Raises the vehicle approximately 2 in (51 mm))** - This position is intended for off-roading use only where maximum ground clearance is required. To enter OR2, push the “Up” button twice from the NRH position or once from the OR1 position while vehicle speed is below 20 mph (32 km/h). While in OR2, if the vehicle speed exceeds 25 mph (40 km/h) the vehicle height will be automatically lowered to OR1. Off-Road 2 may not be available due to vehicle payload, an EVIC/DID message will be displayed when this occurs. Refer to “Electronic Vehicle Information Center (EVIC)/Driver Information Display (DID)” in “Understanding Your Instrument Panel” in the Owner’s Manual on the DVD for further information.

**Aero Mode (Lowers the vehicle approximately .6 in (15 mm) – 1500 Models Only** - This position provides improved aerodynamics by lowering the vehicle. The vehicle will automatically enter Aero Mode when the vehicle speed remains between 62 mph (100 km/h) and 66 mph (106 km/h) for greater than 20 seconds or if the vehicle speed exceeds 66 mph (106 km/h). The vehicle will return to NRH from Aero Mode if the vehicle speed remains between 30 mph (48 km/h) and 35 mph (56 km/h) for greater than 20 seconds or if the vehicle speed falls below 30 mph (48 km/h).

## **NOTE:**

Automatic Aero Mode may be disabled through vehicle settings in the Electronic Vehicle Information Center (EVIC)/Driver Information Display (DID) when equipped with Uconnect 3.0, or your Uconnect Radio when equipped with Uconnect 5.0, 8.4A, or 8.4AN.

**Entry/Exit Mode (Lowers the vehicle approximately 2 in (51 mm))** - This position lowers the vehicle for easier passenger entry and exit as well as lowering the rear of the vehicle for easier loading and unloading of cargo. To enter Entry/Exit Mode, push the “Down” button once from the NRH while the vehicle speed is below 33 mph (53 km/h). Once the vehicle speed goes below 15 mph (24 km/h) the vehicle height will begin to lower. If the vehicle speed remains between 15 mph (24 km/h) and 25 mph (40 km/h) for greater than 60 seconds, or the vehicle speed exceeds 25 mph (40 km/h) the Entry/Exit change will be cancelled. To return to Normal Height Mode, push the “Up” button once while in Entry/Exit or drive the vehicle over 15 mph (24 km/h). Entry/Exit mode may not be available due to vehicle payload, an EVIC/DID message will be displayed when this occurs. Refer to “Electronic Vehicle Information Center (EVIC)/Driver Information Display (DID)” in “Understanding Your Instrument Panel” in the Owner’s Manual on the DVD for further information.

## Air Suspension Modes

The Air Suspension system has multiple modes to protect the system in unique situations:

### Tire Jack Mode

To assist with changing a spare tire, the air suspension system has a feature which allows the automatic leveling to be disabled. Refer to “Electronic Vehicle Information Center (EVIC)/Driver Information Display (DID)” in “Understanding Your Instrument Panel” in the Owner’s Manual on the DVD for further information.

#### **NOTE:**

This mode is intended to be enabled with engine running.

### Transport Mode

To assist with flat bed towing, the air suspension system has a feature which will put the vehicle into Entry/Exit height and disable the automatic load leveling system. Refer to “Electronic Vehicle Information Center (EVIC)/Driver Information Display (DID)” in “Understanding Your Instrument Panel” in the Owner’s Manual on the DVD for further information.

#### **NOTE:**

This mode is intended to be enabled with engine running.

### Wheel Alignment Mode

Before performing a wheel alignment, this mode must be enabled. Refer to “Electronic Vehicle Information Center (EVIC)/Driver Information Display (DID)” in “Understanding Your Instrument Panel” in the Owner’s Manual on the DVD for further information.

#### **NOTE:**

This mode is intended to be enabled with engine running.

### Protection Mode

In order to “protect” the air suspension system, the vehicle will enter Protection Mode when the payload has been exceeded or load leveling cannot be achieved. Refer to “Electronic Vehicle Information Center (EVIC)/Driver Information Display (DID)” in “Understanding Your Instrument Panel” in the Owner’s Manual on the DVD for further information.

#### **NOTE:**

This mode is intended to be enabled with engine running.

# OPERATING YOUR VEHICLE

## REBEL AIR SUSPENSION SYSTEM

The air suspension system provides full time load leveling capability along with the benefit of being able to adjust vehicle height by the push of a button.

Automatic height changes will occur based on vehicle speed and the current vehicle height. The indicator lamps and EVIC/DID messages will operate the same for automatic changes and user requested changes.

### Description

**Normal Ride Height (NRH)** – This is the standard position of the suspension and is meant for normal driving.

**Off-Road (OR)** (Raises the vehicle approximately 1 in [26 mm]) – This position is intended for off-roading use only where maximum ground clearance is required. To enter OR, push the “Up” button once from the NRH position while vehicle speed is below 20 mph (32 km/h). While in OR, if the vehicle speed exceeds 25 mph (40 km/h) the vehicle height will be automatically lowered to NRH. Off-Road may not be available due to vehicle payload, an EVIC/DID message will be displayed when this occurs. Refer to “Electronic Vehicle Information Center (EVIC) or Driver Information Display (DID)” in “Understanding Your Instrument Panel” in your Owner’s Manual on the DVD for further information.

**Aero Mode** (Lowers the vehicle approximately .6 in [15 mm]) – This position provides improved aerodynamics by lowering the vehicle. The vehicle will automatically enter Aero Mode when the vehicle speed remains between 62 mph (100 km/h) and 66 mph (106 km/h) for greater than 20 seconds or if the vehicle speed exceeds 66 mph (106 km/h). The vehicle will return to NRH from Aero Mode if the vehicle speed remains between 30 mph (48 km/h) and 35 mph (56 km/h) for greater than 20 seconds or if the vehicle speed falls below 30 mph (48 km/h).

### NOTE:

Automatic Aero Mode may be disabled through vehicle settings on your Uconnect Radio when equipped with Uconnect 5.0, 8.4A, or 8.4AN. Refer to “Uconnect Settings” in “Understanding Your Instrument Panel” in your Owner’s Manual on the DVD for further information.



**Rebel Air Suspension Controls**

- 1 — Normal Ride Height Indicator Lamp (Customer selectable)
- 2 — Off-Road Indicator Lamp (Customer selectable)
- 3 — Up Button
- 4 — Down Button
- 5 — Entry/Exit Mode Indicator Lamp (Customer selectable)
- 6 — Aero Mode Indicator Lamp (Customer selectable)



# OPERATING YOUR VEHICLE

**Entry/Exit Mode (Lowers the vehicle approximately 3 in [73 mm])** – This position lowers the vehicle for easier passenger entry and exit as well as lowering the rear of the vehicle for easier loading and unloading of cargo. To enter Entry/Exit Mode, push the “Down” button twice from the NRH while the vehicle speed is below 33 mph (53 km/h). Once the vehicle speed goes below 15 mph (24 km/h) the vehicle height will begin to lower. If the vehicle speed remains between 15 mph (24 km/h) and 25 mph (40 km/h) for greater than 60 seconds, or the vehicle speed exceeds 25 mph (40 km/h) the Entry/Exit change will be cancelled. To return to Normal Height Mode, push the “Up” button twice while in Entry/Exit or drive the vehicle over 15 mph (24 km/h). Entry/Exit mode may not be available due to vehicle payload, an EVIC/DID message will be displayed when this occurs. Refer to “Electronic Vehicle Information Center (EVIC) or Driver Information Display (DID)” in “Understanding Your Instrument Panel” in your Owner’s Manual on the DVD for further information.

## **Air Suspension Modes**

The Air Suspension system has multiple modes to protect the system in unique situations:

### **Tire/Jack Mode**

To assist with changing a spare tire, the air suspension system has a feature which allows the automatic leveling to be disabled. Refer to “Electronic Vehicle Information Center (EVIC) or Driver Information Display (DID)” in “Understanding Your Instrument Panel” in your Owner’s Manual on the DVD for further information.

#### **NOTE:**

This mode is intended to be enabled with engine running.

### **Transport Mode**

To assist with flat bed towing, the air suspension system has a feature which will put the vehicle into Entry/Exit height and disable the automatic load leveling system. Refer to “Electronic Vehicle Information Center (EVIC) or Driver Information Display (DID)” in “Understanding Your Instrument Panel” in your Owner’s Manual on the DVD for further information.

#### **NOTE:**

This mode is intended to be enabled with engine running and all doors closed.

### **Wheel Alignment Mode**

Before performing a wheel alignment this mode must be enabled. Refer to “Electronic Vehicle Information Center (EVIC) or Driver Information Display (DID)” in “Understanding Your Instrument Panel” in your Owner’s Manual on the DVD for further information.

#### **NOTE:**

This mode is intended to be enabled with engine running and all doors closed.

# OPERATING YOUR VEHICLE

## Protection Mode

In order to “protect” the air suspension system, the vehicle will enter Protection Mode when load leveling cannot be achieved. Some driving may be required to clear the protection mode telltale in the EVIC/DID. Refer to “Electronic Vehicle Information Center (EVIC) or Driver Information Display (DID)” in “Understanding Your Instrument Panel” in your Owner’s Manual on the DVD for further information.

### NOTE:

If equipped with a touch screen radio all enabling/disabling of air suspension features must be done through the radio. Refer to “Uconnect Settings” in “Understanding Your Instrument Panel” in your Owner’s Manual on the DVD for further information.

## 2500-3500 AIR SUSPENSION SYSTEM

The air suspension system provides full time rear load leveling capability for all loading conditions including towing.

## Description

**Normal Ride Height (NRH)** - This is the standard position of the suspension and is meant for normal driving.

**Trailer Mode (Lowers the vehicle approximately 1 in (25 mm))** - This position will lower the rear suspension and provide load leveling for all loading conditions including towing a trailer. After the “ALT TRAILER HEIGHT” button has been pushed, it will blink continuously until the trailer height has been achieved. The

system requires that the ignition be in the ON/RUN position or the engine running with zero vehicle speed for all user requested changes. After the engine is turned off, it may be noticed that the air suspension system operates briefly, this is normal. The system is correcting the position of the vehicle to ensure a proper appearance.

**Trailer Decoupling/Unloading** - The air suspension system will load level (lower/exhaust only) for up to 10 minutes after the vehicle is turned off. This allows for easy removal of a trailer and/or load from the back of the truck by maintaining the ride height. After 10 minutes you will need to turn the ignition to the run position for the air suspension to maintain ride height. If the air suspension system is disabled using the settings menu (Tire Jack Mode, Transport Mode or Alignment Mode) the system will remain disabled when the vehicle is turned off. Reactivating the air suspension can be accomplished via the settings menu or driving the vehicle above 5 mph (8 km/h) for Tire Jack Mode or Alignment Mode and 16 mph (26 km/h) for Transport Mode.



**Alt Trailer Height Button**

**NOTE:**

While loading, engine must be running for air suspension to maintain the ride height. Refer to your Owner's Manual on the DVD for further details.

## Air Suspension Modes

The Air Suspension system has multiple modes to protect the system in unique situations:

### Tire Jack Mode

To assist with changing a spare tire, the air suspension system has a feature which allows the automatic leveling to be disabled. Refer to "Electronic Vehicle Information Center (EVIC)/Driver Information Display (DID)" in "Understanding Your Instrument Panel" in the Owner's Manual on the DVD for further information.

**NOTE:**

This mode is intended to be enabled with engine running.

### Transport Mode

To assist with flat bed towing, the air suspension system has a feature which will put the vehicle into Entry/Exit height and disable the automatic load leveling system. Refer to "Electronic Vehicle Information Center (EVIC)/Driver Information Display (DID)" in "Understanding Your Instrument Panel" in the Owner's Manual on the DVD for further information.

**NOTE:**

This mode is intended to be enabled with engine running.

### Wheel Alignment Mode

Before performing a wheel alignment, this mode must be enabled. Refer to "Electronic Vehicle Information Center (EVIC)/Driver Information Display (DID)" in "Understanding Your Instrument Panel" in the Owner's Manual on the DVD for further information.

**NOTE:**

This mode is intended to be enabled with engine running.

### Protection Mode

In order to "protect" the air suspension system, the vehicle will enter Protection Mode when the payload has been exceeded or load leveling cannot be achieved. Refer to "Electronic Vehicle Information Center (EVIC)/Driver Information Display (DID)" in "Understanding Your Instrument Panel" in the Owner's Manual on the DVD for further information.

**NOTE:**

This mode is intended to be enabled with engine running.

# OPERATING YOUR VEHICLE

## STOP/START SYSTEM — IF EQUIPPED

The Stop/Start function is developed to save fuel and reduce emissions. The system will stop the engine automatically during a vehicle stop if the required conditions are met. Releasing the brake pedal will automatically re-start the vehicle.

### Automatic Mode

The Stop/Start feature is enabled after every normal customer engine start. It will remain in STOP/START NOT READY until you drive forward with a vehicle speed greater than 5 mph (8 km/h). At that time, the system will go into STOP/START READY and if all other conditions are met, can go into an STOP/START AUTO STOP ACTIVE “Autostop” mode.

#### To Activate The Autostop Mode, The Following Must Occur:

1. The system must be in STOP/START READY state. A STOP/START READY message will be displayed in the Electronic Vehicle Information Center (EVIC)/ Driver Information Display (DID) within the Stop/Start section. Refer to “Electronic Vehicle Information Center (EVIC) or Driver Information Display (DID)” in “Electronics” for further information.
2. The vehicle must be completely stopped.
3. The transmission Gear Selector must be in DRIVE and the brake pedal depressed.

The engine will shut down, the tachometer will move to the zero position and the stop/start telltale will illuminate indicating you are in an Autostop. While in an Autostop, the Climate Controls system may automatically adjust airflow to maintain cabin comfort. Customer settings will be maintained upon return to an engine running condition.

### Possible Reasons The Engine Does Not Autostop

Prior to engine shut down, the system will check many safety and comfort conditions to see if they are fulfilled. In following situations, the engine will not stop:

- Driver's seat belt is not buckled.
- Driver's door is not closed.
- Outside temperature is less than 1°F (-17°C) or greater than 104°F (40°C).
- Battery temperature too warm or cold.
- The vehicle is on a steep grade.
- Cabin heating or cooling is in process and an acceptable cabin temperature has not been achieved.
- HVAC is set to full defrost mode at a high blower speed.
- Engine has not reached normal operating temperature.
- Battery discharged.
- The transmission is not in DRIVE.

# OPERATING YOUR VEHICLE

- Hood is open.
- Vehicle is in 4LO transfer case mode.

Other factors which can inhibit AutoStop include: fuel level, accelerator pedal input, engine temp too high and steering angle.

It may be possible for the vehicle to be driven several times without the STOP/START system going into a STOP/START READY state under more extreme conditions of the items listed above.

## **To Start The Engine While In Autostop Mode**

While in DRIVE, the engine will start when the brake pedal is released or the throttle pedal is depressed. The transmission will automatically reengage upon engine restart. During this transition, the brakes will hold the vehicle to avoid undesired vehicle movement.

### **Conditions That Will Cause The Engine To Start Automatically While In Autostop Mode**

The engine will start automatically when:

- The transmission selector is moved from DRIVE to REVERSE or NEUTRAL
- To maintain cabin temperature near the HVAC settings
- HVAC is set to full defrost mode
- Autostop time exceeds 5 minutes
- Battery voltage drops too low
- Low brake vacuum (e.g. after several brake pedal applications)
- STOP/START OFF switch is pushed
- 4WD system is put into 4LO mode
- The emissions system requires it
- A STOP/START system error occurs

### **Conditions That Force An Automatic Shift To Park While In Autostop Mode**

The engine will not start automatically and the transmission will be placed in PARK if:

- The driver door is open and brake pedal released
- The driver door is open and the driver seat belt is unbuckled
- The engine hood has been opened
- A STOP/START system error occurs

The engine may then be restarted by moving the transmission shift selector out of PARK (e.g. to DRIVE) or, in some cases, only by a KEY START. The Electronic Vehicle Information Center (EVIC)/Driver Information Display (DID) will display a SHIFT OUT OF PARK message, or a STOP/START KEY START REQUIRED message, to indicate which action is required.

# OPERATING YOUR VEHICLE

Refer to “Electronic Vehicle Information Center (EVIC) or Driver Information Display (DID)” in “Understanding Your Instrument Panel” in your Owner’s Manual on the DVD for further information.

## To Manually Turn Off The Stop Start System

1. Push the STOP/START Off switch (located on the switch bank). The light on the switch will illuminate.
2. The STOP/START OFF message will appear in Electronic Vehicle Information Center (EVIC)/Driver Information Display (DID). Refer to “Electronic Vehicle Information Center (EVIC) or Driver Information Display (DID)” in “Electronics” for further information.
3. At the next vehicle stop (after turning off the STOP/START system) the engine will not be stopped.
4. If the STOP/START system is manually turned off, the engine can only be started and stopped by cycling the ignition switch.
5. The STOP/START system will reset itself back to an ON condition every time the key is turned off and back on.



**STOP/START OFF Switch**

## To Manually Turn On The Stop Start System

1. Push the STOP/START Off switch (located on the switch bank).
2. The light on the switch will turn off.

## System Malfunction

If there is a malfunction in the STOP/START system, the system will not shut down the engine. A “SERVICE STOP/START SYSTEM” message will appear in the Electronic Vehicle Information Center (EVIC)/Driver Information Display (DID). Refer to “Electronic Vehicle Information Center (EVIC)” or “Driver Information Display (DID)” in “Electronics” for further information.

The system will need to be checked by your authorized dealer.

# OPERATING YOUR VEHICLE

## MANUAL CLIMATE CONTROLS WITHOUT TOUCHSCREEN



Manual Climate Controls

- |                                   |                           |
|-----------------------------------|---------------------------|
| 1 — Rotate Blower Control         | 4 — Push A/C Button       |
| 2 — Push Air Recirculation Button | 5 — Rotate Mode Control   |
| 3 — Rotate Temperature Control    | 6 — Push Defroster Button |

### Air Recirculation /Max A/C

- Use Recirculation for maximum A/C operation.
- For window defogging, turn the Recirculation button off.
- Recirculation is not allowed in defrost.
- Recirculation is allowed in floor mode and defrost/floor (mix modes) for approximately five minutes.

### Heated Mirrors

The mirrors are heated to melt frost or ice. This feature is activated whenever you turn on the defroster.

# OPERATING YOUR VEHICLE

## MANUAL CLIMATE CONTROLS WITH TOUCHSCREEN



### Uconnect 8.4 Manual Climate Controls

- |                              |                                  |
|------------------------------|----------------------------------|
| 1 — Max A/C Button           | 6 — Blower Speed Up Button       |
| 2 — A/C Button               | 7 — Mode Control Buttons         |
| 3 — Air Recirculation Button | 8 — Blower Speed Down Button     |
| 4 — Front Defroster Button   | 9 — OFF Button                   |
| 5 — Defroster Button         | 10 — Temperature Control Buttons |



# OPERATING YOUR VEHICLE



Climate Control Knobs

- 1 — A/C Button
- 2 — Temperature Control Buttons
- 3 — Front Defroster Button
- 4 — Defroster Button

- 5 — Rotate Blower Control
- 6 — OFF Button
- 7 — Air Recirculation Button

## Air Recirculation

- Use Recirculation for maximum A/C operation.
- For window defogging, turn the Recirculation button off.

## Heated Mirrors

The mirrors are heated to melt frost or ice. This feature is activated whenever you turn on the defroster.

# OPERATING YOUR VEHICLE

## AUTOMATIC CLIMATE CONTROLS WITH TOUCHSCREEN



Uconnect 8.4 Automatic Climate Controls

- |                              |                                |
|------------------------------|--------------------------------|
| 1 — MAX A/C Button           | 8 — Passenger Temperature Down |
| 2 — A/C Button               | 9 — SYNC Button                |
| 3 — Air Recirculation Button | 10 — Blower Control Buttons    |
| 4 — AUTO Button              | 11 — Mode Control Buttons      |
| 5 — Front Defroster Button   | 12 — OFF Button                |
| 6 — Defroster Button         | 13 — Driver Temperature Down   |
| 7 — Passenger Temperature Up | 14 — Driver Temperature Up     |

# OPERATING YOUR VEHICLE



**Climate Control Knobs**

- |                              |                                |
|------------------------------|--------------------------------|
| 1 — A/C Button               | 7 — Defroster Button           |
| 2 — Driver Temperature Up    | 8 — Passenger Temperature Down |
| 3 — OFF Button               | 9 — AUTO Button                |
| 4 — Blower Control Knob      | 10 — Driver Temperature Down   |
| 5 — Passenger Temperature Up | 11 — Recirculation Button      |
| 6 — Front Defroster Button   |                                |

## **Air Conditioning (A/C)**

- If the air conditioning button is pressed while in AUTO mode, the system will exit AUTO mode and stay in A/C. The mode and blower will be set at the closest mode and blower position that the system was operating in AUTO.

## **SYNC Temperature Button**

- Press the “SYNC” button on the touchscreen to control the driver and passenger temperatures simultaneously. Press the “SYNC” button on the touchscreen a second time to control the temperatures individually.

# OPERATING YOUR VEHICLE

## Air Recirculation

- Use Recirculation for maximum A/C operation.
- For window defogging, turn the Recirculation button off.
- If the Recirculation button is pushed while in the AUTO mode, the indicator light may flash three times to indicate the cabin air is being controlled automatically.

## Heated Mirrors

The mirrors are heated to melt frost or ice. This feature is activated whenever you turn on the defroster.

## PARKSENSE FRONT AND REAR PARK ASSIST — IF EQUIPPED

The ParkSense Park Assist system provides visual and audible indications of the distance between the rear and/or front fascia and a detected obstacle when backing up or moving forward, e.g. during a parking maneuver. Refer to ParkSense System Usage Precautions for limitations of this system and recommendations.

ParkSense will retain the last system state (enabled or disabled) from the last ignition cycle when the ignition is changed to the ON/RUN position.

ParkSense can be active only when the shift lever is in REVERSE or DRIVE. If ParkSense is enabled at one of these shift lever positions, the system will remain active until the vehicle speed is increased to approximately 7 mph (11 km/h) or above. A display warning will appear in the Electronic Vehicle Information Center (EVIC) or Driver Information Display (DID) indicating the vehicle is above ParkSense operating speed. The system will become active again if the vehicle speed is decreased to speeds less than approximately 6 mph (9 km/h).

## Cleaning The ParkSense Sensors

If "PARKSENSE UNAVAILABLE WIPE REAR SENSORS" or "PARKSENSE UNAVAILABLE WIPE FRONT SENSORS" appears in the "Electronic Vehicle Information Center (EVIC) or Driver Information Display (DID)," clean the ParkSense sensors with water, car wash soap and a soft cloth. Do not use rough or hard cloths. Do not scratch or poke the sensors. Otherwise, you could damage the sensors.

# OPERATING YOUR VEHICLE

## PARKVIEW REAR BACK UP CAMERA — IF EQUIPPED

Your vehicle may be equipped with the ParkView Rear Back Up Camera that allows you to see a image of the rear surroundings of your vehicle whenever the shift lever is put into REVERSE or whenever it is initiated through "Backup Camera" button in the "Controls" menu. Whenever the shift lever is put into REVERSE, the image will be displayed in the rearview mirror display (if equipped) or Uconnect screen (if equipped) along with a caution note to "check entire surroundings" across the top of the screen. After five seconds this note will disappear.

The ParkView camera is located to the left of the tailgate handle.

When the vehicle is shifted out of REVERSE (with camera delay turned OFF), the rear camera mode is exited and the navigation or audio screen appears again.

When the vehicle is shifted out of REVERSE (with camera delay turned ON), The rear camera image will be displayed for up to 10 seconds after shifting out of "REVERSE" unless the forward vehicle speed exceeds 8 mph (13 km/h), the transmission is shifted into "PARK" or the ignition is switched to the OFF position.

Whenever the Rear View Camera image is activated through "Backup Camera" button in the "Controls" menu, a display timer for the image is initiated. The image will continue to be displayed until the display timer exceeds 10 seconds and the vehicle speed is above 8 mph (13 km/h) or the touchscreen button "X" to disable display of the Rear View camera image is pressed.

### NOTE:

If the vehicle speed remains below 8 mph (13 km/h), the Rear View camera image will be displayed continuously until deactivated via. the touchscreen button "X".

If equipped with a Cargo Camera, a touchscreen button  to indicate the current active Camera image being displayed is made available whenever the Rear View camera image is displayed.

If equipped with a Cargo Camera, a touchscreen button  to switch the display to Cargo camera image is made available whenever the Rear View Camera image is displayed.

A touchscreen button "X" to disable display of the camera image is made available when the vehicle is not in REVERSE gear.

# OPERATING YOUR VEHICLE

When enabled, active guide lines are overlaid on the image to illustrate the width of the vehicle and its projected backup path based on the steering wheel position. The active guide lines will show separate zones that will help indicate the distance to the rear of the vehicle.

## NOTE:

For further information about how to access and change the programmable features of the ParkView Rear Backup Camera, refer to "Uconnect Settings" in "Understanding Your Instrument Panel" for further information.

## CAUTION!

- To avoid vehicle damage, ParkView should only be used as a parking aid. The ParkView camera is unable to view every obstacle or object in your drive path.
- To avoid vehicle damage, the vehicle must be driven slowly when using ParkView to be able to stop in time when an obstacle is seen. It is recommended that the driver look frequently over his/her shoulder when using ParkView.

## WARNING!

Drivers must be careful when backing up even when using the ParkView Rear Back Up Camera. Always check carefully behind your vehicle, and be sure to check for pedestrians, animals, other vehicles, obstructions, or blind spots before backing up. You are responsible for the safety of your surroundings and must continue to pay attention while backing up. Failure to do so can result in serious injury or death.

## NOTE:

If snow, ice, mud, or any foreign substance builds up on the camera lens, clean the lens, rinse with water, and dry with a soft cloth. Do not cover the lens.

Turning Rear View Camera image On:

1. Press the "Controls" button located on the bottom of the Uconnect display.
2. Press the "Backup Camera" button  to turn the Rear View Camera system ON.

## NOTE:

Once initiated by the "Backup Camera" button, the Rear View Camera image may be deactivated by pressing the "X" soft button. On deactivation, the previous selected screen will appear.

# OPERATING YOUR VEHICLE

## POWER SLIDING REAR WINDOW

The switch for the power sliding rear window is located on the overhead console.

- Push the switch right to open the glass and pull the switch left to close the glass.



Power Sliding Rear Window Switch

## POWER SUNROOF

- The power sunroof switch is located on the overhead console.

### Opening Sunroof

#### Express Open

Push the switch rearward and release it within one-half second. The sunroof will fully open and stop automatically.

#### Manual Open

Push and hold the switch rearward to open the sunroof. Any release of the switch will stop the movement, and the sunroof will remain in a partially open position until the switch is pushed again.

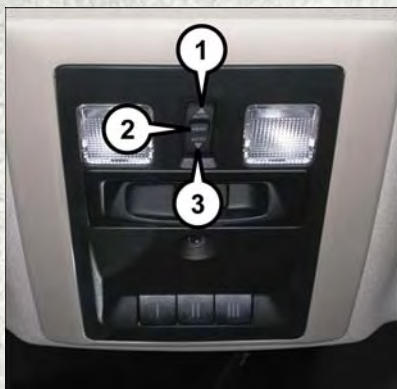

Power Sunroof Switch

- 1 — Opening Sunroof
- 2 — Venting Sunroof
- 3 — Closing Sunroof

# OPERATING YOUR VEHICLE

## Venting Sunroof

Push and release the button and the sunroof will open to the vent position.

This is called “Express Vent” and will occur regardless of sunroof position. During Express Vent operation, any movement of the switch will stop the sunroof.

## Closing Sunroof

### Express Closing

Push the switch forward and release it within one-half second. The sunroof will fully close automatically from any position.

### Manual Closing

Push and hold the switch forward to close the sunroof. Any release of the switch will stop the movement, and the sunroof will remain in a partially closed position until the switch is pushed again.

## Pinch Protection Feature

This feature will detect an obstruction in the opening of the sunroof during Express Close operation. If an obstruction in the path of the sunroof is detected, the sunroof will automatically retract. Remove the obstruction if this occurs. Next, push the switch forward and release to Express Close.

### NOTE:

If three consecutive sunroof close attempts result in Pinch Protect reversals, the fourth close attempt will be a Manual Close movement with Pinch Protect disabled.



## WARNING!

- Do not let children play with the sunroof. Never leave children unattended in a vehicle, or with access to an unlocked vehicle. Do not leave the Key Fob in or near the vehicle, and do not leave the ignition of a vehicle equipped with Keyless Enter-N-Go in the ACC or ON/RUN mode. Occupants, particularly unattended children, can become entrapped by the power sunroof while operating the power sunroof switch. Such entrapment may result in serious injury or death.
- In a collision, there is a greater risk of being thrown from a vehicle with an open sunroof. You could also be severely injured or killed. Always fasten your seat belt properly and make sure all passengers are properly secured.
- Do not allow small children to operate the sunroof. Never allow your fingers, other body parts, or any object to project through the sunroof opening. Injury may result.

## WIND BUFFETING

Wind buffeting can be described as a helicopter-type percussion sound. If buffeting occurs with the rear windows open, adjust the front and rear windows together.

If buffeting occurs with the sunroof open, adjust the sunroof opening, or adjust any window. This will minimize buffeting.

# ELECTRONICS



## YOUR VEHICLE'S SOUND SYSTEM

1. Uconnect Voice Command Button pg. 126
2. Uconnect Phone Button pg. 126
3. Steering Wheel Audio Controls (Left — Behind Steering Wheel) pg. 155
4. Steering Wheel Audio Controls (Right — Behind Steering Wheel) pg. 155
5. Volume Knob/Audio Mute Button
6. Screen Off Button



- 7. Back Button
- 8. Tune/Scroll Knob — Browse/Enter Button
- 9. Uconnect 8.4 Radio pg. 114
- 10. Power Inverter (If Equipped) pg. 162
- 11. USB Port pg. 103
- 12. SD Card pg. 103
- 13. Aux Jack pg. 103
- 14. USB Charge Only Port pg. 163

## CYBERSECURITY

Your vehicle may be a connected vehicle and may be equipped with both wired and wireless networks. These networks allow your vehicle to send and receive information. This information allows systems and features in your vehicle to function properly.

Your vehicle may be equipped with certain security features to reduce the risk of unauthorized and unlawful access to vehicle systems and wireless communications. Vehicle software technology continues to evolve over time and FCA US LLC, working with its suppliers, evaluates and takes appropriate steps as needed. Similar to a computer or other devices, your vehicle may require software updates to improve the usability and performance of your systems or to reduce the potential risk of unauthorized and unlawful access to your vehicle systems.

The risk of unauthorized and unlawful access to your vehicle systems may still exist, even if the most recent version of vehicle software (such as Uconnect software) is installed.

### WARNING!

- It is not possible to know or to predict all of the possible outcomes if your vehicle's systems are breached. It may be possible that vehicle systems, including safety related systems, could be impaired or a loss of vehicle control could occur that may result in an accident involving serious injury or death.
- ONLY insert media (e.g., USB, SD card, or CD) into your vehicle if it came from a trusted source. Media of unknown origin could possibly contain malicious software, and if installed in your vehicle, it may increase the possibility for vehicle systems to be breached.
- As always, if you experience unusual vehicle behavior, take your vehicle to your nearest authorized dealer immediately.

### NOTE:

- FCA or your dealer may contact you directly regarding software updates.
- To help further improve vehicle security and minimize the potential risk of a security breach, vehicle owners should:
  - Routinely check [www.driveuconnect.com/software-update](http://www.driveuconnect.com/software-update) to learn about available Uconnect software updates.
  - Only connect and use trusted media devices (e.g. personal mobile phones, USBs, CDs).

Privacy of any wireless and wired communications cannot be assured. Third parties may unlawfully intercept information and private communications without your consent. For further information, refer to "Privacy Practices – If Equipped with Uconnect 8.4 radio" in "All About Uconnect Access" in your Owner's Manual Radio Supplement and "Onboard Diagnostic System (OBD II) Cybersecurity" in "Maintaining Your Vehicle" in your Owner's Manual on the DVD.

## IDENTIFYING YOUR RADIO

### Radio 3.0

- Two buttons on the faceplate on either side of the display



Radio 3.0

### Uconnect 3.0

- Two buttons on the faceplate on either side of the display
- Phone pick up button on the faceplate



Uconnect 3.0

### Uconnect 5.0

- 5" Touchscreen
- Three buttons on the faceplate on either side of the display



Uconnect 5.0

# ELECTRONICS

## Uconnect 8.4A

- 8.4" Touchscreen
- HD Button will NOT be visible on right side of screen when viewing AM or FM
- SiriusXM Travel Link feature NOT listed within Apps



Uconnect 8.4A

## Uconnect 8.4AN

- 8.4" Touchscreen
- HD Button will be visible on right side of screen when viewing AM or FM
- SiriusXM Travel Link feature listed within Apps



Uconnect 8.4AN

## UCONNECT ACCESS

### Uconnect Access — If Equipped (Available On Uconnect 8.4A/8.4AN — U.S. Residents Only)

#### WARNING!

- ALWAYS obey traffic laws and pay attention to the road. Some Uconnect Access services, including 9-1-1 and Assist, will NOT work without an operable 1X (voice/data) or 3G (data) network connection.
- ALWAYS drive safely with your hands on the steering wheel. You have full responsibility and assume all risks related to the use of the Uconnect features and applications in this vehicle. Only use Uconnect when it is safe to do so. Failure to do so may result in an accident involving serious injury or death.

#### NOTE:

Your vehicle may be transmitting data as authorized by the subscriber.

Uconnect Access enhances your ownership and driving experience by connecting your vehicle to an operable 1X (voice/data) or 3G (data) network. When connected to an operable 1X (voice/data) or 3G (data) network, you can:

- Place a call to a local 9-1-1 Operator for emergency assistance.
- Remotely lock/unlock your doors and start your vehicle from virtually anywhere, using the Uconnect Access App from your device. You can also do so by logging into Mopar Owner Connect, or by calling Uconnect Care when your vehicle has an operable 1X (voice/data) or 3G (data) network connection. Services can only be used where coverage is available; see coverage map for details.
- Turn your vehicle into a WiFi Hotspot and connect your devices to the internet.
- Receive text or email notifications if your vehicle's theft alarm goes off.
- Receive stolen vehicle assistance, using GPS technology to help authorities locate your vehicle if it is stolen.
- Listen to your text messages or send free-form text messages with your voice while keeping your hands on the wheel, using the Voice Texting feature. Requires a device that supports Bluetooth Message Access Profile (MAP).
- Search for places to eat, shop, relax and play with Yelp, using your voice or on-screen menu. Then navigate to them (navigation standard on Uconnect 8.4AN, optional on Uconnect 8.4A).
- Get operator assistance using the ASSIST button on your interior rearview mirror.

## **Before you drive, familiarize yourself with the easy-to-use Uconnect Access.**

1. The ASSIST and 9-1-1 buttons are located on your rearview mirror. The ASSIST button is used for contacting Roadside Assistance, Vehicle Care and Uconnect Care. The 9-1-1 button connects you to emergency services.

### **NOTE:**

Vehicles sold in Canada and Mexico DO NOT have 9-1-1 call system capabilities. 9-1-1 or other emergency line operators in Canada and Mexico may not answer or respond to 9-1-1 system calls.

2. The Uconnect “Apps  ” button in the center of the menu bar of the radio touchscreen. This is where you can begin your registration process, manage your Apps and purchase WiFi on demand.
3. The Uconnect Voice Command and Uconnect Phone buttons are located on the left side of your steering wheel. These buttons let you use your voice to give commands, make phone calls, send and receive text messages hands-free, enter navigation destinations, and control your radio and media devices.

## **Included Trial Period For New Vehicles**

Your new vehicle may come with an included trial period for use of the Uconnect Access Services starting at the date of vehicle purchase (date based on vehicle sales notification from your dealer). **To activate the trial, you must first register with Uconnect Access.** After the trial period, if you wish to continue your Uconnect Access Services you can choose to purchase a subscription.

## **Features And Packages**

- After the trial period, you can subscribe to continue your service by visiting the Uconnect Store located within the Mopar Owner Connect website [moparownerconnect.com](http://moparownerconnect.com). If you need assistance, U.S. residents can call Uconnect Care at 1-855-792-4241 .
- For the latest information on packages and pricing information: U.S. residents visit [DriveUconnect.com](http://DriveUconnect.com).



## Uconnect Access Registration (Uconnect 8.4A/8.4AN, U.S. 48 Contiguous States, Alaska And Hawaii)

To unlock the full potential of Uconnect Access in your vehicle, you first need to register with Uconnect Access.

1. Push the ASSIST button on your rearview mirror.
2. Press the “Uconnect Care” button on the touchscreen.
3. A helpful Uconnect Care Agent will register your vehicle and handle all of the details.

**Signing up is easy!** Simply follow the steps above. Or, press the “Apps  ” button on the touchscreen, then select the Uconnect registration app to “Register By Web” and complete the process using your device or computer.



**ASSIST Button**

**Why sign up for Uconnect Access?** Here are just a few examples of things you'll be able to do:

- Know that help, if you need it, is only a button press away.
- Lock and unlock your vehicle doors from hundreds of miles away.
- Discover great, new places around you using Yelp.
- Dictate and send text messages by speaking out loud (all while keeping both hands on the wheel!)
- Enjoy the best in music and entertainment from around the world with apps like Pandora.

For further information please visit [DriveUconnect.com](http://DriveUconnect.com).

## Download The Uconnect Access App

You're only a few steps away from using remote commands and playing your favorite music in your vehicle.

To link your internet radio accounts:

1. Download the **Uconnect Access App** on your device.
2. Press the Via Mobile icon on the navigation bar at the bottom of the app.
3. Press the app you'd like to connect to your vehicle.
4. Enter your login information for the selected app and press Link.
5. Next time you're in your vehicle, enable Bluetooth, pair your device and select the Via Mobile app you want to play from the Uconnect touchscreen to stream your personalized music.



### NOTE:

- You can also complete this process on the web. Simply visit [moparownerconnect.com](http://moparownerconnect.com) log in and click **Set Up Via Mobile Profile** (under Quick Links).
- Once you download the app to your compatible device, you will also be able to start your vehicle and lock/unlock its doors from virtually anywhere.

## Via Mobile Apps — If Equipped

- **Aha by HARMAN** — Aha by HARMAN makes it easy to instantly access your favorite Web content on the go. Choose from over 40,000+ stations spanning internet radio, personalized music, news, entertainment, hotels, weather, audiobooks, Facebook, Twitter, and more.
- **iHeartRadio** — iHeartRadio provides instant access to more than 1,500 live radio stations from across the country and allows listeners to create custom music stations inspired by their favorite artists or songs.
- **Pandora** — Pandora gives people the music and comedy they love anytime, anywhere. Personalized stations launch instantly, with the input of a favorite artist, track, comedian, or genre.
- **Slacker Radio** — Enjoy millions of songs and hundreds of handcrafted stations.

### NOTE:

For detailed information on how to use Via Mobile apps visit the Mopar Owner Connect website [moparownerconnect.com](http://moparownerconnect.com) and log in using the username and password you set up when registering for Uconnect Access.



## Renewing Subscriptions And Purchasing WiFi Hotspot (Uconnect 8.4A/8.4AN, U.S. 48 Contiguous States, Alaska And Hawaii)

Subscriptions, and WiFi Hotspot, can be purchased from the Uconnect Store within your vehicle, and online at Mopar Owner Connect. If you need help push the ASSIST button on the rearview mirror, then select Uconnect Care (or dial 1-855-792-4241).

### NOTE:

You must set up a Uconnect Access Payment Account online (log in to [moparownerconnect.com](http://moparownerconnect.com), go to Edit Profile, then Uconnect Payment Account, to set up and manage your Payment Account).

# ELECTRONICS

## Getting Started With Apps

Applications (Apps for short) in your Uconnect Access system are designed to deliver the features and services that you want. There are two basic categories:

1. **Built-In Features** — use the 1X (voice/data) or 3G (data) network on your Uconnect 8.4A or 8.4AN radio.
2. **Uconnect Access Via Mobile** — use the Uconnect Access App and your device's data plan to access your personal Pandora, iHeartRadio, Aha and Slacker accounts from the vehicle and control them using the touchscreen. Customer's data plan charges will apply. Available on Uconnect 8.4A and 8.4AN Radios (if equipped).

### Apps Main Menu

Press the “Apps  ” button on the touchscreen to open the Apps main menu, in this screen you will be able to access all of your available Apps. To access an App directly, press the corresponding button on the touchscreen and you will be directed to that App. To view the rest of your Apps, press the page forward or page back button.

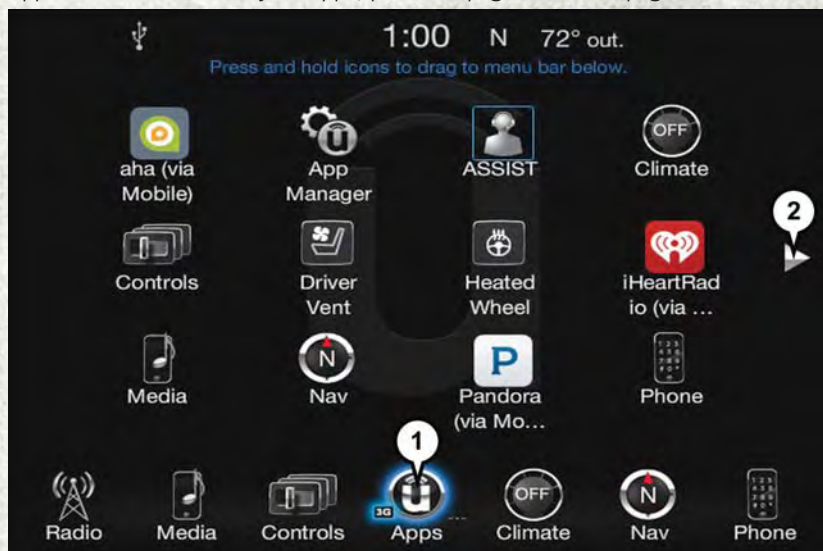

### Uconnect Apps

1 — Apps Button

2 — Page Forward Button

## App Manager

Press the “App Manager” button to access the following categories:

**Favorite Apps** — This is the default screen when you first press the “App Manager” button on the touchscreen, and is a good place to put the apps you use most frequently. To make an App a “favorite”, press the “Settings” button on the touchscreen to the right of the App.

**All Apps** — All of your available Apps will reside in the “All Apps” folder.

**Running Apps** — Press this tab to see which apps are currently running.

## Maintaining Your Uconnect Access Account

### Selling Your Vehicle

When you sell your vehicle, we recommend that you remove your Uconnect Access Account information from the vehicle. You can do this on the Mopar Owner Connect website [moparownerconnect.com](http://moparownerconnect.com). Removing your account information cancels your subscription and makes your vehicle factory-ready for a new owner/subscriber.

For additional information on Uconnect:

- U.S. residents - visit [DriveUconnect.com](http://DriveUconnect.com) or call 1-877-855-8400 .
- Canadian Residents - visit [DriveUconnect.ca](http://DriveUconnect.ca) or call, 1-800-465-2001 (English) or 1-800-387-9983 (French).

## Built-In Features

### WARNING!

- ALWAYS obey traffic laws and pay attention to the road. Some Uconnect Access services, including 9-1-1 and Assist, will NOT work without an operable 1X (voice/data) or 3G (data) network connection.
- ALWAYS drive safely with your hands on the steering wheel. You have full responsibility and assume all risks related to the use of the Uconnect features and applications in this vehicle. Only use Uconnect when it is safe to do so. Failure to do so may result in an accident involving serious injury or death.
- Ignoring the rearview mirror light could mean you may not have 9-1-1 Call service if needed. If the rearview mirror light is illuminated, have an authorized dealer service the 9-1-1 Call system immediately.
- The Occupant Restraint Controller (ORC) turns on the Air Bag Warning Light on the instrument panel if a malfunction is detected in any part of the airbag system. If the Air Bag Warning Light is illuminated, the air bag system may not be working properly and the 9-1-1 system may not send a signal to a 9-1-1 operator if an air bag is deployed. If the Air Bag Warning Light is illuminated, have an authorized dealer service your vehicle immediately.
- If anyone in the vehicle could be in danger (e.g., fire or smoke is visible, dangerous road conditions or location), do not wait for voice contact from a 9-1-1 operator. All occupants should exit the vehicle immediately and move to a safe location.
- The 9-1-1 Call system is embedded into the vehicle's electrical system. Do not add aftermarket electrical equipment to the vehicle's electrical system. This may prevent your vehicle from sending a signal to initiate an emergency call. To avoid interference that can cause the 9-1-1 Call system to fail, never add aftermarket equipment (e.g., two-way mobile radio, CB radio, data recorder, etc.) to your vehicle's electrical system or modify the antennas on your vehicle.
- IF YOUR VEHICLE LOSES BATTERY POWER FOR ANY REASON (INCLUDING DURING OR AFTER AN ACCIDENT), the Uconnect features, apps and services, among others, will not operate.

**NOTE:**

Your vehicle may be transmitting data as authorized by the subscriber.

1. **Assist Call (8.4AN)** — The rearview mirror contains an ASSIST push button which automatically connects the vehicle occupants to one of these predefined destinations for immediate support:

- **Roadside Assistance Call** — If you get a flat tire, or need a tow, you'll be connected to someone who can help anytime. Additional fees may apply. Additional information in this section.
- **Uconnect Access Care** — In vehicle support for Uconnect Access System, Apps and Features.
- **Vehicle Care** — Total support for your FCA US LLC vehicle.



**ASSIST And 9-1-1 Buttons**

2. **Emergency 9-1-1 Call (If Equipped)** — The rearview mirror contains a 9-1-1 button that, when pressed, may place a call from your vehicle to a local 9-1-1 operator to request help from local police, fire or ambulance personnel. If this button is accidentally pressed, you will have 7 seconds to stop the call. To cancel, press the 9-1-1 Call button again or press the "Cancel" button shown on the touchscreen. After 7 seconds has passed, the 9-1-1 call will be placed and only the 9-1-1 operator can cancel it. The LED light on the rearview mirror will turn green once a connection to a 9-1-1 operator has been made. The green LED light will turn off once the 9-1-1 call is terminated. Have an authorized dealer service the vehicle if the rearview mirror light is continuously red. On equipped vehicles, this feature requires a functioning electrical system and an operable 1X (voice/data) or 3G (data) network connection to function properly. **If a connection is made between a 9-1-1 operator and your vehicle, you understand and agree that 9-1-1 operators may, like any other 9-1-1 call, record conversations and sounds in and near your vehicle upon connection.**
3. **Roadside Assistance (If Equipped)** — If your vehicle is equipped with this feature and has an operable 1X (voice/data) or 3G (data) network connection, you may be able to connect with Roadside Assistance by pushing the "ASSIST" button on the rearview mirror. You will be presented with Assist Care options. Make a selection by pressing the prompts displayed on the radio. If Roadside Assistance is provided to your vehicle, you agree to be responsible for any additional roadside assistance service costs that you may incur. In order to provide Uconnect Services to you, we may record and monitor your conversations with Roadside Assistance, Uconnect Care or Vehicle Care, whether such conversations are initiated through the Uconnect Services in your vehicle, your device or via a landline device, and

- 1 — ASSIST Button
- 2 — 9-1-1 Button

may share information obtained through such recording and monitoring in accordance with regulatory requirements. You acknowledge, agree and consent to any recording, monitoring or sharing of information obtained through any such call recordings.

4. **Yelp** — Customers have the ability to search for nearby destinations or a Point Of Interest (POI) either by category or custom search by using keywords (for example, “Italian restaurant”). Searching can be done by either voice or by using the touch-screen keypad. Using the touchscreen, launch Yelp by selecting the “Apps  ” icon, then press “Yelp.” To use voice recognition, push the VR button on the steering wheel and say “launch Yelp,” then follow the instructions on the Teleprompter.
5. **Security Alarm Notification** — The Security Alarm Notification feature notifies you via email or text (SMS) message when the vehicle’s factory-installed security alarm system has been set-off. There are a number of reasons why your alarm may have been triggered, one of which could be that your vehicle was stolen. If so, please see the details of the Stolen Vehicle Assistance service below. When you register, Security Alarm Notification is automatically set to send you an email at the mail address you provide should the alarm go off. You may also opt to have a text message sent to your device.
6. **Stolen Vehicle Assistance** — If your vehicle is stolen, contact local law enforcement immediately to file a stolen vehicle report. Once this report has been filed, Uconnect care can help locate your vehicle. The Uconnect Care agent will ask for the stolen vehicle report number issued by local law enforcement. As long as your vehicle has an operable 1X (voice/data) or 3G (data) network connection, the Uconnect Care Agent may be able to locate the stolen vehicle and work with law enforcement to help recover it. Your vehicle must have an operable 1X (voice/data) or 3G (data) network connection and must be registered with Uconnect Access with an active subscription that includes the applicable feature.
7. **WiFi Hotspot** — WiFi Hotspot is an in-vehicle feature that connects your device to an operable 1X (voice/data) or 3G (data) network using Uconnect Access and is ready to go where ever you are. Once your vehicle is registered for Uconnect Access, you can purchase a Wifi Hotspot subscription at the Uconnect Store. After you've made your purchase, turn on your signal and connect your passengers devices. It's never been easier to bring your home or office with you.

## WARNING!

NEVER use the WiFi Hotspot when you are driving the vehicle. As the driver, you should only use the WiFi Hotspot when the vehicle is parked in a safe location. Failure to do so may result in an accident involving serious injury or death.

### NOTE:

Your vehicle must have a working electrical system for any of the in vehicle Uconnect features to operate.



## Uconnect Access Remote Features

If you own a compatible iPhone or Android powered device, the Uconnect Access App allows you to remotely lock or unlock your doors, start your engine or activate your horn and lights from virtually anywhere. Your vehicle must be equipped with remote start and your vehicle must have an operable 1X (voice/data) or 3G (data) network connection). Services can only be used where coverage is available; see coverage map for details. You can download the App from Mopar Owner Connect or from the App Store (iPhone) or Google Play store. Visit [UconnectPhone.com](http://UconnectPhone.com) to determine if your device is compatible. For Uconnect Phone customer support and to determine if your device is compatible.

U.S. residents - visit [UconnectPhone.com](http://UconnectPhone.com) or call 1-877-855-8400.

**Remote Start (If Equipped)** — This feature provides the ability to start the engine on your vehicle, without the keys and from virtually any distance. You can send a request to your vehicle in one of two ways:

1. Using the Uconnect Access App from a compatible device.
2. From the Mopar Owner Connect website.
  - After 15 minutes if you have not entered your vehicle with the key, the engine will shut off automatically.
  - You can also send a command to turn-off an engine that has been remote started.
  - This remote function requires your vehicle to be equipped with a factory-installed Remote Start system. To utilize this feature after the Uconnect Access App is downloaded, login with your user name and password.

### NOTE:

Your four digit Uconnect Security PIN is required to confirm the request.

- You can set-up notifications for your account to receive an email or text (SMS) message every time a command is sent. Login to Mopar Owner Connect [moparownerconnect.com](http://moparownerconnect.com) and click on Edit Profile to manage Uconnect Notifications.

**Remote Door Lock/Unlock** — This feature provides the ability to lock or unlock the door on your vehicle, without the keys and from virtually any distance. You can send a request to your vehicle in one of three ways:

1. Using the Uconnect Access App from a compatible device.
2. From the Mopar Owner Connect website.
3. By contacting the Uconnect Care on the phone.

To use this feature after the Uconnect Access App is downloaded, login using your user name and password. You will need your four digit Uconnect Security PIN to confirm the request. Press the “closed lock” icon on your Uconnect Access App to lock the doors, and press the “open Lock” icon to unlock the driver’s door.

You can set-up notifications for your account to receive an email or text (SMS) message every time a command is sent. Login to Mopar Owner Connect [moparownerconnect.com](http://moparownerconnect.com) and click on Edit Profile to manage Uconnect Notifications.

**Remote Horn And Lights** — It's easy to locate a vehicle in a dark, crowded or noisy parking area by activating the horn and lights. It may also help if you need to draw attention to your vehicle for any reason. You can send a request to your vehicle in one of three ways:

1. Using the Uconnect Access App from a compatible device.
2. From the Mopar Owner Connect website.
3. By contacting the Uconnect Care on the phone.

To use this feature after the Uconnect Access App is downloaded, login using your user name and password. You will need your four digit Uconnect Security PIN to confirm the request. You can set-up notifications for your account to receive an email or text (SMS) message every time a command is sent. Login to Mopar Owner Connect [moparownerconnect.com](http://moparownerconnect.com) and click on Edit Profile to manage Uconnect Notifications.

**Voice Texting** — Want to dictate a personal message? Register with Uconnect Access to take advantage of a new, cloudbased Voice Texting service, an enhancement to Voice Text Reply.

Voice Texting allows you to compose a new text or reply to an incoming text message. Before you attempt to use the Voice Texting feature, check to ensure you have the following:

1. A paired, Bluetooth enabled device with the Message Access Profile (MAP). Not all Bluetooth enabled devices support MAP, including all iPhones (Apple iOS). Visit [UconnectPhone.com](http://UconnectPhone.com) for system and device compatibility information.
2. An active Uconnect Access trial or paid subscription.
3. Accept the "Allow MAP" profile request on your device. (Please refer to device manufacturer instructions for details).

**To Send A Text Message:**

1. Push the Uconnect Phone Button  on the steering wheel.
2. Wait for the beep.
3. Say "Text."
4. Uconnect will prompt you "Say the phone number, or full name and phone type of the contact you want to send a message to."
5. Wait for the beep and say a contact that is in your phonebook, or a mobile phone number that you would like to send the message to.
6. Uconnect will prompt you "Please say the message that you would like to send." (If you do not hear this prompt, you may not have an active subscription with Uconnect Access).
7. Wait for the beep, and then dictate any message up to 140 characters. If you exceed 140 characters, you will hear the following prompt: "Message was too long; your message will be truncated."
8. Uconnect will then repeat the message back to you.
9. Uconnect will prompt you: "To add to your message, say "Continue"; To delete the current message and start over, say "Start Over"; to send the current message, say "Send"; to hear the message again, say "Repeat".
10. If you are happy with your message and would like to send it, wait for the beep and say "Send".
11. Uconnect will then say "Sending your message."

**Sample Commands For Voice Text Reply And Voice Texting**

Example Command	Action
"Text John Smith"	Send a message to specific contact in address book
"Text 123 456 7890"	Send 123 456 7890 a message from your phonebook
"Show messages"	See recent text messages listed by number on Uconnect screen
"Listen to/view (message number four, for example)"	Hear messages or read it on Uconnect screen
"Reply"	Send a voice text reply to a current message
"Forward text/message to "John Smith"	Forward current text to specific contact in address book
"Forward text/message to "123 456 7890"	Forward current text to specific phone number

## RADIO 3.0

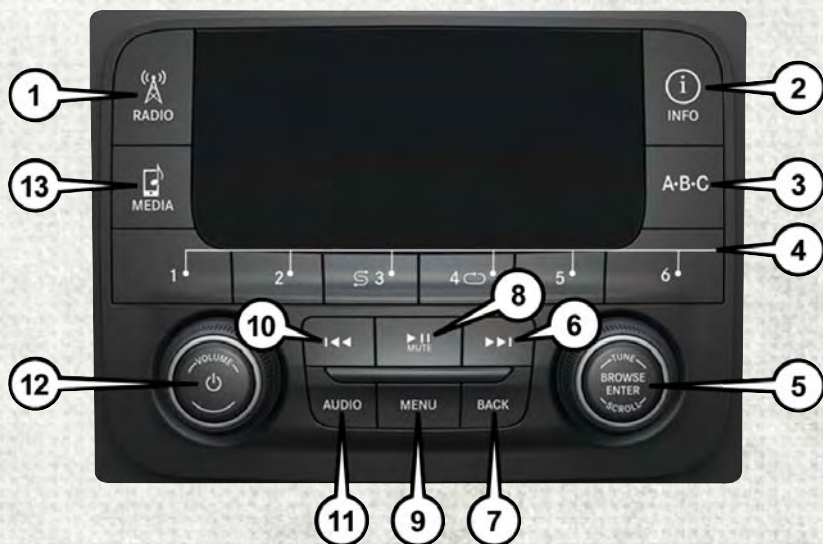

Radio 3.0

- |   |                                     |
|---|-------------------------------------|
| 1 — RADIO Button                              | 8 — Play/Pause — Mute Button        |
| 2 — INFO Button                               | 9 — MENU Button                     |
| 3 — A-B-C Button                              | 10 — SEEK Down Button               |
| 4 — Preset Buttons                            | 11 — AUDIO Button                   |
| 5 — BROWSE/ENTER Button —<br>TUNE/SCROLL Knob | 12 — ON/OFF Button — Volume<br>Knob |
| 6 — SEEK Up Button                            | 13 — MEDIA Button                   |
| 7 — BACK Button                               |                                     |

### Clock Setting

1. Push the Menu button at the bottom of the radio, and push the Enter/Browse button for System Settings. Next, select the Time and Format setting and then select Set Time by pushing the Enter/Browse button.
2. Adjust the hours or minutes by turning the Tune/Scroll knob, then pushing the Enter/Browse button to move to the next entry. You can also select 12hr or 24hr format by turning the Tune/Scroll knob, then pushing the Enter/Browse button on the desired selection.
3. Once the time is set press the “Back” button to exit the time screen.

## Audio Setting

- Push the MENU button on the radio faceplate.
- The Audio Menu shows the following options for you to customize your audio settings.

### Treble, Mid, Bass, Fade, Balance, Speed Adjusted Volume, Loudness and AUX Offset

- Select the desired setting to adjust, then push the ENTER/BROWSE button. Turn the TUNE/SCROLL knob to adjust the setting + or - . Push the “Back” button when done.

## Radio Operation

### Seek Up/Down Buttons

- Push the up or down button to seek through radio stations in AM, FM or SXM bands.
- Hold either button to bypass stations without stopping.

### Store Radio Presets Manually

The Presets are available for all Radio Modes, and are activated by pushing any of the six Preset buttons. The Radio stores up to 18 presets in each of the Radio modes. Push the A-B-C button on the faceplate to select the A, B or C preset list.

To store a radio preset manually, follow the steps below:

1. Tune to the desired station.
2. Push and hold the desired numbered button for more than two seconds, or until you hear a confirmation beep.

## Disc Operation (If Equipped)

Your vehicle may have a remote CD player located in the lower center console storage bin, or in the lower center bench seat bin.

- CD/Disc Mode is entered by either inserting a CD/Disc or by pushing the MEDIA button located on the side of the display. Once in Media Mode, select “Disc.”

Gently insert one CD into the CD player with the CD label facing as indicated on the illustration located on the Disc player.

### Seek Up/Down Buttons

- Push to seek through CD tracks.
- Hold either button to bypass tracks without stopping.

## USB/Audio Jack (AUX) Manual Operation

To select a specific audio source, push the MEDIA button on the faceplate and select from the following modes:

### USB/iPod

- USB/iPod Mode is entered by either inserting a USB Jump Drive or iPod cable into the USB port or by pushing the MEDIA button located left of the display.

# ELECTRONICS

## Audio Jack (AUX)

- The AUX allows a device such as an MP3 player or an iPod to be plugged into the radio and utilize the vehicle's audio system, using a 3.5 mm audio cable, to amplify the source and play through the vehicle's speakers.
- The functions of the device are controlled using the device buttons, not the buttons on the radio. The volume may be controlled using the radio or the device.

## UCONNECT 3.0

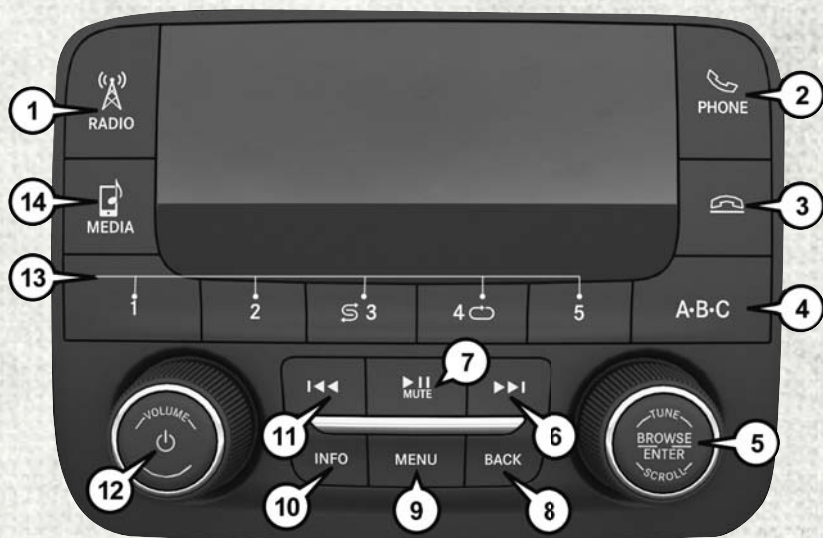

Uconnect 3.0 Radio

- |   |                                     |
|---|-------------------------------------|
| 1 — RADIO Button                              | 8 — BACK Button                     |
| 2 — Phone Pick-Up Button                      | 9 — MENU Button                     |
| 3 — Phone Hang-Up Button                      | 10 — INFO Button                    |
| 4 — A-B-C Button                              | 11 — SEEK Down Button               |
| 5 — BROWSE/ENTER Button —<br>TUNE/SCROLL Knob | 12 — ON/OFF Button — Volume<br>Knob |
| 6 — SEEK Up Button                            | 13 — Preset Buttons                 |
| 7 — Play/Pause — Mute Button                  | 14 — MEDIA Button                   |

## Clock Setting

1. Push the Menu button at the bottom of the radio, and push the Enter/Browse button for System Settings. Next, select the Time and Format setting and then select Set Time by pushing the Enter/Browse button.
2. Adjust the hours or minutes by turning the Tune/Scroll knob, then pushing the Enter/Browse button to move to the next entry. You can also select 12hr or 24hr format by turning the Tune/Scroll knob, then pushing the Enter/Browse button on the desired selection.
3. Once the time is set press the "Back" button to exit the time screen.

## Audio Setting

- Push the MENU button on the radio faceplate.
- The Audio Menu shows the following options for you to customize your audio settings.

### Treble, Mid, Bass, Fade, Balance, Speed Adjusted Volume, Loudness and AUX Offset

- Select the desired setting to adjust, then push the ENTER/BROWSE button. Turn the TUNE/SCROLL knob to adjust the setting + or - . Push the "Back" button when done.

## Radio Operation

### Seek Up/Down Buttons

- Push the up or down button to seek through radio stations in AM, FM or SXM bands.
- Hold either button to bypass stations without stopping.

### Store Radio Presets Manually

The Presets are available for all Radio Modes, and are activated by pushing any of the six Preset buttons. The Radio stores up to 18 presets in each of the Radio modes. Push the A-B-C button on the faceplate to select the A, B or C preset list.

To store a radio preset manually, follow the steps below:

1. Tune to the desired station.
2. Push and hold the desired numbered button for more than two seconds, or until you hear a confirmation beep.

## Disc Operation (If Equipped)

Your vehicle may have a remote CD player located in the lower center console storage bin, or in the lower center bench seat bin.

- CD/Disc Mode is entered by either inserting a CD/Disc or by pushing the MEDIA button located on the side of the display. Once in Media Mode, select “Disc.”

Gently insert one CD into the CD player with the CD label facing as indicated on the illustration located on the Disc player.

### Seek Up/Down Buttons

- Push to seek through CD tracks.
- Hold either button to bypass tracks without stopping.

## USB/Audio Jack (AUX) Manual Operation

To select a specific audio source, push the MEDIA button on the faceplate and select from the following modes:

### USB/iPod

- USB/iPod Mode is entered by either inserting a USB Jump Drive or iPod cable into the USB port or by pushing the MEDIA button located left of the display.

### Audio Jack (AUX)

- The AUX allows a device such as an MP3 player or an iPod to be plugged into the radio and utilize the vehicle's audio system, using a 3.5 mm audio cable, to amplify the source and play through the vehicle's speakers.
- The functions of the device are controlled using the device buttons, not the buttons on the radio. The volume may be controlled using the radio or the device.



## Uconnect 3.0 VOICE RECOGNITION QUICK TIPS

### Introducing Uconnect

Start using Uconnect Voice Recognition with these helpful quick tips. It provides the key Voice Commands and tips you need to know to control your Uconnect 3.0 system.



Uconnect 3.0

## Get Started

1. U.S. residents can visit **UconnectPhone.com** to check device and feature compatibility and to find device pairing instructions.
2. Reduce background noise. Wind and passenger conversations are examples of noise that may impact recognition.
3. Speak clearly at a normal pace and volume while facing straight ahead. The microphone is positioned on the rearview mirror and aimed at the driver.
4. Each time you give a Voice Command, you must first push either the VR or Phone button, wait until **after** the beep, then say your Voice Command.
5. You can interrupt the help message or system prompts by pushing the VR or Phone button and saying a Voice Command from current category.

All you need to control your Uconnect system with your voice are the buttons on your steering wheel.

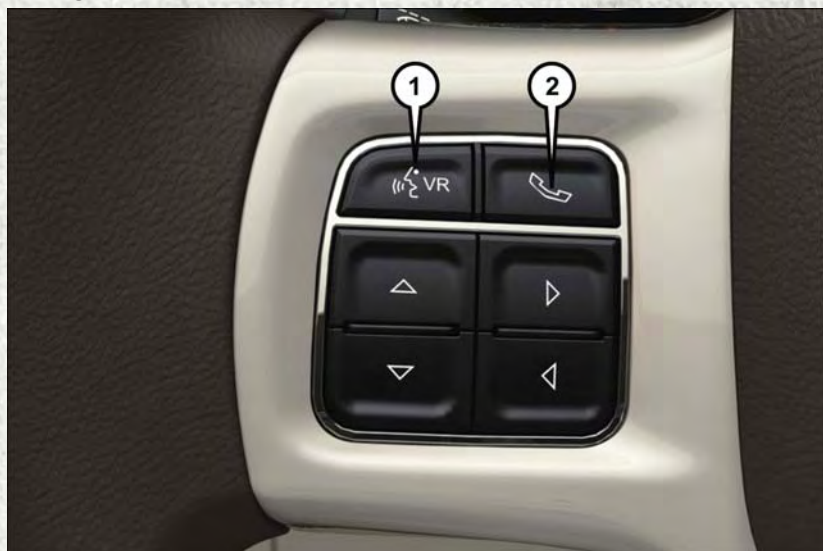

**Uconnect VR And Phone Buttons**

- 1 — Push To Begin Radio Or Media Functions  
2 — Push To Initiate, Answer, Or End A Phone Call, Send Or Receive A Text
-

## Radio

Use your voice to quickly get to the AM, FM or SiriusXM Satellite Radio stations you would like to hear. (Subscription or included SiriusXM Satellite Radio trial required.)

Push the VR button . After the beep, say:

- **Tune to** ninety-five-point-five FM
- **Tune to** Satellite Channel Hits 1

**TIP:** At any time, if you are not sure of what to say or want to learn a Voice Command, push the VR button  and say **“Help.”** The system will provide you with a list of commands.

## Media

Uconnect offers connections via USB, SD, Bluetooth and auxiliary ports (If Equipped). Voice operation is only available for connected USB and iPod devices. (Remote CD player optional and not available on all vehicles.)

Push the VR button . After the beep, say one of the following commands and follow the prompts to switch your media source or choose an artist.

- **Change source** to Bluetooth
- **Change source** to iPod
- **Change source** to USB
- **Play artist** Beethoven; **Play album** Greatest Hits; **Play song** Moonlight Sonata; **Play genre** Classical

**TIP:** Press the Browse button on the touchscreen to see all of the music on your iPod or USB device. Your Voice Command must match **exactly** how the artist, album, song and genre information is displayed.

## Phone

Making and answering hands-free phone calls is easy with Uconnect. When the Phonebook button is illuminated on your touchscreen, your system is ready.

U.S. residents can visit [UconnectPhone.com](http://UconnectPhone.com) to check device and feature compatibility and to find device pairing instructions.

Push the Phone button . After the beep, say one of the following commands...

- **Call** John Smith
- **Dial** 123-456-7890 and follow the system prompts
- **Redial** (call previous outgoing phone number)
- **Call back** (call previous incoming phone number)

**TIP:** When providing a Voice Command, push the Phone button  and say “**Call,**” then pronounce the name **exactly** as it appears in your phone book. When a contact has multiple phone numbers, you can say “**Call John Smith work.**”

## Voice Text Reply

Uconnect will announce **incoming** text messages. Push the Phone button  and say **Listen**. (Must have compatible device paired to Uconnect system.)

1. Once an incoming text message is read to you, push the Phone button . After the beep, say: **Reply**.
2. Listen to the Uconnect prompts. After the beep, repeat one of the pre-defined messages and follow the system prompts.

**TIP:** Your device must have the full implementation of the **Message Access Profile (MAP)** to take advantage of this feature. For details about MAP, visit [UconnectPhone.com](http://UconnectPhone.com) for U.S. residents. Apple iPhone iOS6 or later supports reading **incoming** text messages only.

PRE-DEFINED VOICE TEXT REPLY RESPONSES		
Yes.	Stuck in Traffic.	See you later.
No.	Start without me.	I'll be Late.
Okay.	Where are you?	I will be <number> minutes late.
Call me.	Are you there yet?	
I'll call you later.	I need directions.	See you in <number> of minutes.
I'm on my way.	Can't talk right now.	Thanks.
I'm lost.		

## Additional Information

© 2015 FCA US LLC. All rights reserved. Mopar, Mopar Owner Connect and Uconnect are registered trademarks of FCA US LLC. Android is a trademark of Google Inc. SiriusXM and all related marks and logos are trademarks of SiriusXM Radio Inc. Yelp, Yelp logo, Yelp burst and related marks are registered trademarks of Yelp.

Uconnect System Support:

- U.S. residents visit [DriveUconnect.com](http://DriveUconnect.com) or call: 1-877-855-8400 (24 hours a day 7 days a week)
- Canadian residents visit [DriveUconnect.ca](http://DriveUconnect.ca) or call: 1-800-465-2001 (English) or 1-800-387-9983 (French)

Mon. – Fri., 8:00 am – 8:00 pm, ET

Sat., 9:00 am – 5:00 pm, ET

Sun., Closed

Uconnect Access Services Support. 1-855-792-4241 Please have your Uconnect Security PIN ready when you call.

## UCONNECT 5.0



Uconnect 5.0 Radio

- |                                     |                                  |
|-------------------------------------|----------------------------------|
| 1 — RADIO Button                    | 6 — Back Button                  |
| 2 — COMPASS Button                  | 7 — Screen OFF Button            |
| 3 — SETTINGS Button                 | 8 — Mute Button — Volume Control |
| 4 — MORE Button                     | 9 — Uconnect Phone Button        |
| 5 — Browse/Enter — Tune/Scroll Knob | 10 — MEDIA Button                |

**CAUTION!**

Do NOT attach any object to the touchscreen, doing so can result in damage to the screen.

## Clock Setting

To start the clock setting procedure, perform the following:

1. Push the **SETTINGS** button on the faceplate on the right side of the display, then press the “Clock & Date” button on the touchscreen.
2. Press the “Set Time & Format” button on the touchscreen.
3. Press the “Up” or “Down” arrows to adjust the hours or minutes, next select the “AM” or “PM” button on the touchscreen. You can also select 12hr or 24hr format by pressing the desired button on the touchscreen.
4. Once the time is set press the “Done” button on the touchscreen to exit the time screen.

### NOTE:

In the Clock Setting Menu you can also select Display Clock. Display Clock turns the clock display in the status bar on or off.

## Equalizer, Balance And Fade

1. Push the **SETTINGS** button on the faceplate on the right side of the unit.
2. Then scroll down and press the “Audio” button on the touchscreen to get to the Audio menu.
3. The Audio Menu shows the following options for you to customize your audio settings.

### Equalizer

- Press the “Equalizer” button on the touchscreen to adjust the Bass, Mid and Treble. Use the “+” or “-” button on the touchscreen to adjust the equalizer to your desired settings. Press the “Done” button on the touchscreen when finished.

### Balance/Fade

- Press the “Balance/Fade” button on the touchscreen to adjust the sound from the speakers. Use the “arrow” button on the touchscreen to adjust the sound level from the front and rear or right and left side speakers. Press the Center “C” button on the touchscreen to reset the balance and fade to the factory setting. Press the “Done” button on the touchscreen when finished.

### Speed Adjustable

- Press the “Speed Adjusted Volume” button on the touchscreen to select between OFF, 1, 2 or 3. This will decrease the radio volume relative to a decrease in vehicle speed. Press the “Done” button on the touchscreen when finished.

### Loudness

- Press the “Loudness” button on the touchscreen to select the Loudness feature. When this feature is activated it improves sound quality at lower volumes.

## Radio Operation



Uconnect 5.0 Radio Screen

- 1 — Radio Station Presets
- 2 — Show All Presets
- 3 — Seek Up
- 4 — Audio Settings

- 5 — Station Info
- 6 — Direct Tune
- 7 — Radio Band
- 8 — Seek Down

### Seek Up/Down Buttons

- Press the up or down button to seek through radio stations in AM, FM or SXM bands.
- Hold either button to bypass stations without stopping.

### Store Radio Presets Manually

The Radio stores up to 12 presets in each of the Radio modes. There are four visible presets at the top of the radio screen. Pressing the "All" button on the touchscreen on the radio home screen will display all of the preset stations for that mode.

To store a radio preset manually, follow the steps below:

1. Tune to the desired station
2. Press and hold the desired preset button on the touchscreen for more than two seconds or until you hear a confirmation beep.

## SiriusXM Premier Over 160 channels

Get every channel available on your satellite radio, and enjoy all you want, all in one place. Hear commercial-free music plus sports, news, talk and entertainment. Get all the premium programming, including Howard Stern, every NFL game, Oprah Radio, every MLB and NHL game, every NASCAR race, Martha Stewart and more. And get 20+ extra channels, including SiriusXM Latino, offering 20 channels of commercial free music, news, talk, comedy, sports and more dedicated to Spanish language programming.

To access SiriusXM Satellite Radio, push the RADIO button on the faceplate and then the SXM button on the touchscreen.

SiriusXM services require subscriptions, sold separately after the 12-month trial included with the new vehicle purchase. **If you decide to continue your service at the end of your trial subscription, the plan you choose will automatically renew and bill at then-current rates until you call SiriusXM at 1-866-635-2349 for U.S. residents and 1-888-539-7474 for Canadian residents to cancel. See SiriusXM Customer Agreement for complete terms at [www.siriusxm.com](http://www.siriusxm.com) for U.S. residents and [www.siriusxm.ca](http://www.siriusxm.ca) for Canadian residents.** All fees and programming subject to change. Our satellite service is available only to those at least 18 and older in the 48 contiguous USA and D.C. Our Sirius satellite service is also available in PR (with coverage limitations). Our Internet radio service is available throughout our satellite service area and in AK and HI. © 2015 Sirius XM Radio Inc. Sirius, XM and all related marks and logos are trademarks of Sirius XM Radio Inc.

## Disc Operation (If Equipped)

Your vehicle may have a remote CD player located in the lower center console storage bin, or in the lower center bench seat bin.

- CD/Disc Mode is entered by either inserting a CD/Disc or by pushing the MEDIA button located on the side of the display. Once in Media Mode, select “Disc.”
- Gently insert one CD into the CD player with the CD label facing as indicated on the illustration located on the Disc player.

## Seek Up/Down Buttons

- Press to seek through Disc tracks.
- Hold either button to bypass tracks without stopping.

## Browse

- Press the “Browse” button on the touchscreen to scroll through and select a desired track on the Disc. Press the “Exit” button on the touchscreen if you want to cancel the browse function.



**USB/Audio Jack (AUX)/SD CARD — If Equipped**

To select a specific audio source, push the MEDIA button on the faceplate. To allow music to play from your device through the vehicle's speakers, press the "Source" button then select one of the following modes:

**USB/iPod**

- USB/iPod Mode is entered by either inserting a USB Jump Drive or iPod cable into the USB port or by pushing the MEDIA button on the faceplate located left of the display.

**Audio Jack (AUX)**

- The AUX allows a device, such as an MP3 player or an iPod, to be plugged into the radio and utilize the vehicle's audio system, using a 3.5 mm audio cable, to amplify the source and play through the vehicle speakers.
- The functions of the device are controlled using the device buttons, not the buttons on the radio. The volume may be controlled using the radio or device.

**SD Card**

- Play songs stored on an SD card inserted into the SD card slot.
- Song playback can be controlled using the radio or Steering Wheel Audio Controls to play, skip to the next or previous track, browse, and list the contents.

**Bluetooth**

- If using a Bluetooth-equipped device, you may also be able to stream music to your vehicle's sound system.

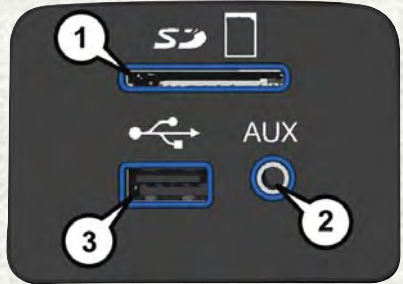
**Uconnect Media Hub**

- 1 — SD Card Port
- 2 — Audio/AUX Jack
- 3 — USB Port

# ELECTRONICS

## Uconnect 5.0 VOICE RECOGNITION QUICK TIPS

### Introducing Uconnect

Start using Uconnect Voice Recognition with these helpful quick tips. It provides the key Voice Commands and tips you need to know to control your Uconnect 5.0 system.

Key Features:

- 5" touchscreen
- Three buttons on either side of the display



Uconnect 5.0

## Get Started

1. U.S. residents can visit **UconnectPhone.com** to check device and feature compatibility and to find device pairing instructions.
2. Reduce background noise. Wind and passenger conversations are examples of noise that may impact recognition.
3. Speak clearly at a normal pace and volume while facing straight ahead. The microphone is positioned on the rearview mirror and aimed at the driver.
4. Each time you give a Voice Command, you must first press either the VR or Phone button, wait until **after** the beep, then say your Voice Command.
5. You can interrupt the help message or system prompts by pressing the VR or Phone button and saying a Voice Command from current category.

All you need to control your Uconnect system with your voice are the buttons on your steering wheel.

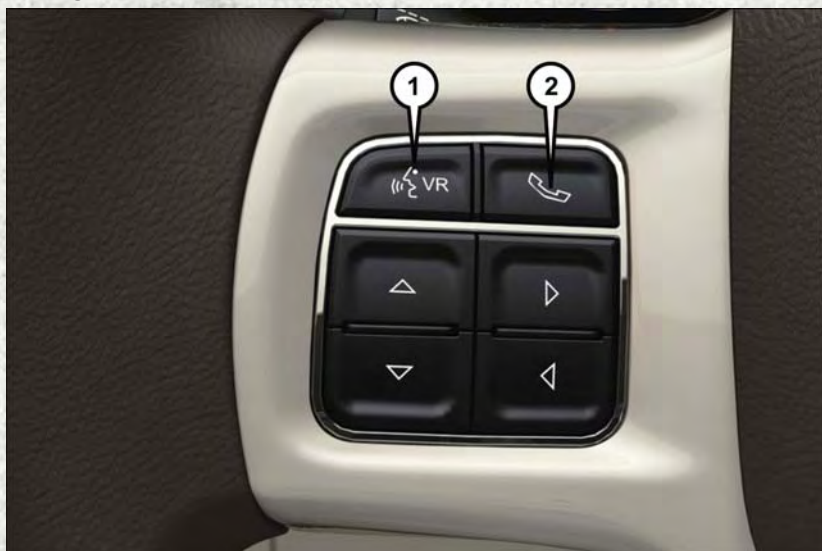

**Uconnect VR/Phone Buttons**

- 1 — Push To Begin Radio Or Media Functions  
2 — Push To Initiate, Answer, Or End A Phone Call, Send Or Receive A Text
-

## Basic Voice Commands

The basic Voice Commands below can be given at any point while using your Uconnect system.

Push the VR button . After the beep, say:

- **Cancel** to stop a current voice session
- **Help** to hear a list of suggested Voice Commands
- **Repeat** to listen to the system prompts again

Notice the visual cues that inform you of your voice recognition system's status. Cues appear on the touchscreen.

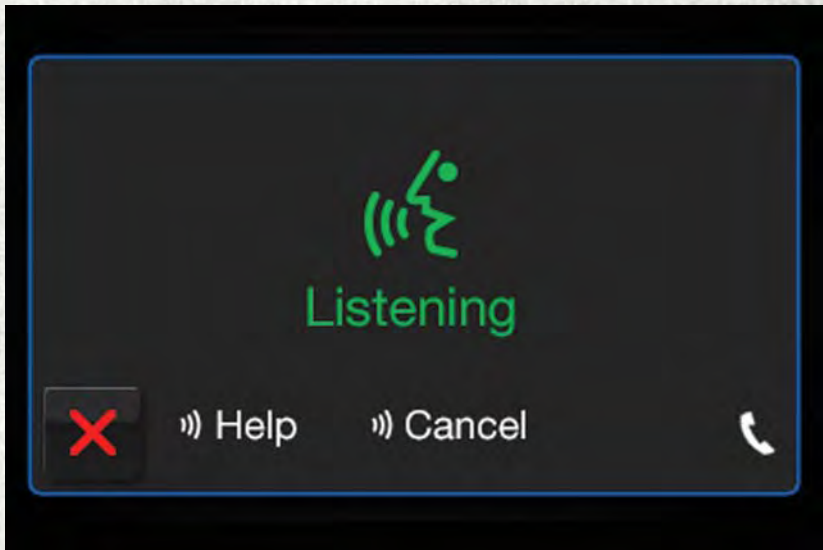

Uconnect 5.0 Visual Cues

## Radio

Use your voice to quickly get to the AM, FM or SiriusXM Satellite Radio stations you would like to hear. (Subscription or included SiriusXM Satellite Radio trial required.)

Push the VR button . After the beep, say:

- **Tune to** ninety-five-point-five FM
- **Tune to** Satellite Channel Hits 1

**TIP:** At any time, if you are not sure of what to say or want to learn a Voice Command, push the VR button  and say **"Help."** The system will provide you with a list of commands.



Uconnect 5.0 Radio

## Media

Uconnect offers connections via USB, SD, Bluetooth and auxiliary ports (If Equipped). Voice operation is only available for connected USB and iPod devices. (Remote CD player optional and not available on all vehicles.)

Push the VR button . After the beep, say one of the following commands and follow the prompts to switch your media source or choose an artist.

- **Change source** to Bluetooth
- **Change source** to iPod
- **Change source** to USB
- **Play artist** Beethoven; **Play album** Greatest Hits; **Play song** Moonlight Sonata; **Play genre** Classical

**TIP:** Press the Browse button on the touchscreen to see all of the music on your iPod or USB device. Your Voice Command must match **exactly** how the artist, album, song and genre information is displayed.

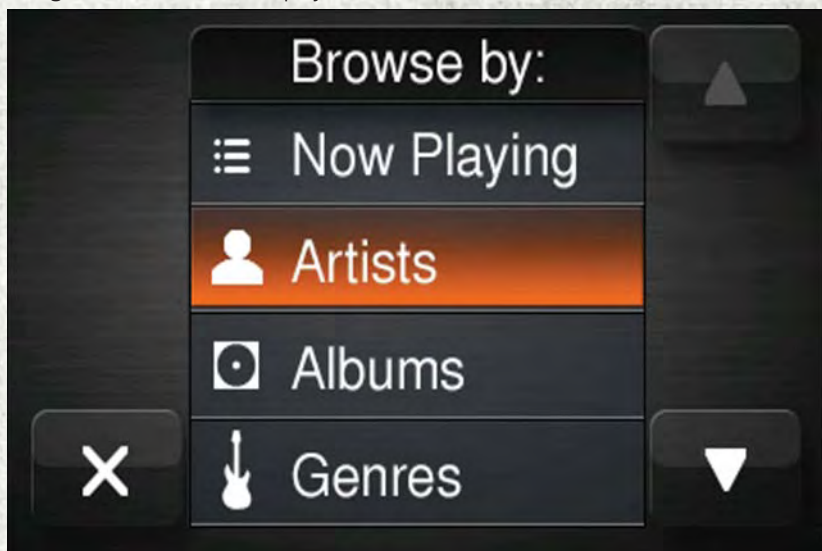

Uconnect 5.0 Media

## Phone

Making and answering hands-free phone calls is easy with Uconnect. When the Phonebook button is illuminated on your touchscreen, your system is ready.

U.S. residents can visit [UconnectPhone.com](http://UconnectPhone.com) to check device and feature compatibility and to find device pairing instructions.

Push the Phone button . After the beep, say one of the following commands...

- **Call** John Smith
- **Dial** 123-456-7890 and follow the system prompts
- **Redial** (call previous outgoing phone number)
- **Call back** (call previous incoming phone number)

**TIP:** When providing a Voice Command, push the Phone button  and say **“Call,”** then pronounce the name **exactly** as it appears in your phone book. When a contact has multiple phone numbers, you can say **“Call John Smith work.”**



Uconnect 5.0 Phone

## Voice Text Reply

Uconnect will announce **incoming** text messages. Push the Phone button  and say **Listen**. (Must have compatible device paired to Uconnect system.)

1. Once an incoming text message is read to you, push the Phone button . After the beep, say: **Reply**.
2. Listen to the Uconnect prompts. After the beep, repeat one of the pre-defined messages and follow the system prompts.

**TIP:** Your device must have the full implementation of the **Message Access Profile (MAP)** to take advantage of this feature. For details about MAP, visit [UconnectPhone.com](http://UconnectPhone.com) for U.S. residents. Apple iPhone iOS6 or later supports reading **incoming** text messages only.

PRE-DEFINED VOICE TEXT REPLY RESPONSES		
Yes.	Stuck in Traffic.	See you later.
No.	Start without me.	I'll be Late.
Okay.	Where are you?	I will be <number> minutes late.
Call me.	Are you there yet?	
I'll call you later.	I need directions.	See you in <number> minutes.
I'm on my way.	Can't talk right now.	
I'm lost.		Thanks.

## Additional Information

© 2015 FCA US LLC. All rights reserved. Mopar, Mopar Owner Connect and Uconnect are registered trademarks of FCA US LLC. Android is a trademark of Google Inc. SiriusXM and all related marks and logos are trademarks of SiriusXM Radio Inc. Yelp, Yelp logo, Yelp burst and related marks are registered trademarks of Yelp.

Uconnect System Support:

- U.S. residents visit [DriveUconnect.com](http://DriveUconnect.com) or call: 1-877-855-8400 (24 hours a day 7 days a week)
- Canadian residents visit [DriveUconnect.ca](http://DriveUconnect.ca) or call: 1-800-465-2001 (English) or 1-800-387-9983 (French)

Mon. – Fri., 8:00 am – 8:00 pm, ET

Sat., 9:00 am – 5:00 pm, ET

Sun., Closed

Uconnect Access Services Support: 1-855-792-4241. Please have your Uconnect Security PIN ready when you call.



## Uconnect 8.4A/8.4AN

### Uconnect 8.4A/8.4AN At A Glance



Uconnect 8.4AN Radio Screen

### CAUTION!

Do NOT attach any object to the touchscreen, doing so can result in damage to the screen.

#### Setting The Time

- Model 8.4AN synchronizes time automatically via GPS, so it should not require any time adjustment. If you do need to set the time manually, follow the instructions below for Model 8.4A.
- For Model 8.4A, turn the unit on, then press the time display at the top of the screen. Press “Yes.”
- If the time is not displayed at the top of the screen, press the “Settings” button on the touchscreen. In the Settings screen, press the “Clock” button on the touchscreen, then check or uncheck this option.
- Press “+” or “-” next to Set Time Hours and Set Time Minutes to adjust the time.
- If these features are not available, uncheck the Sync Time box.
- Press “X” to save your settings and exit out of the Clock Setting screen.

## **Background Themes**

- Screen background themes are selectable from a pre-loaded list of themes. If you'd like to set a theme, follow the instructions below.
- Press the "Settings" button on the touchscreen.
- Press the "Display" button on the touchscreen.
- Then press "Set Theme" button on the touchscreen and select a theme.

## **Audio Settings**

- Press of the "Audio" button on the touchscreen to activate the Audio settings screen to adjust Balance\Fade, Equalizer, and Speed Adjusted Volume.
- You can return to the Radio screen by pressing the "X" located at the top right.

## **Balance/Fade**

- Press the "Balance/Fade" button on the touchscreen to Balance audio between the front speakers or fade the audio between the rear and front speakers.
- Pressing the "Front," "Rear," "Left," or "Right" buttons on the touchscreen or press and drag the Speaker Icon to adjust the Balance/Fade.

## **Equalizer**

- Press the "Equalizer" button on the touchscreen to activate the Equalizer screen.
- Press the "+" or "-" buttons on the touchscreen, or press and drag over the level bar for each of the equalizer bands. The level value, which spans between plus or minus 9, is displayed at the bottom of each of the Bands.

## **Speed Adjusted Volume**

- Press the "Speed Adjusted Volume" button on the touchscreen to activate the Speed Adjusted Volume screen. The Speed Adjusted Volume is adjusted by pressing the volume level indicator. This alters the automatic adjustment of the audio volume with variation to vehicle speed.

## Personalized Menu Bar

The Uconnect features and services in the main menu bar are easily changed for your convenience. Simply follow these steps:

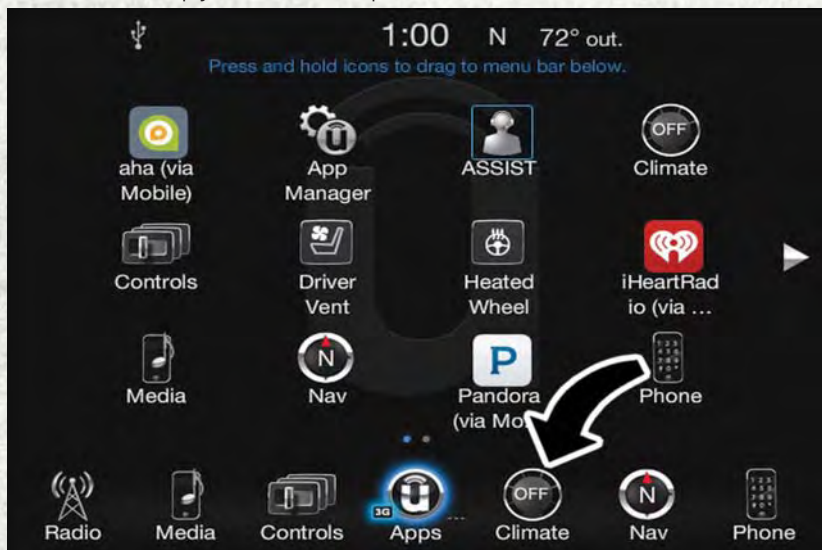

Uconnect 8.4A/8.4AN Main Menu

1. Press the “Apps  ” button to open the App screen.
2. Press and hold, then drag the selected App to replace an existing shortcut in the main menu bar.

The replaced shortcut will now be an active App/shortcut on the main menu bar.

## Radio



Uconnect 8.4AN Radio

- |                               |                                    |
|-------------------------------|------------------------------------|
| 1 — Radio Station Presets     | 7 — Audio Settings                 |
| 2 — Toggle Between Presets    | 8 — Seek Up                        |
| 3 — Status Bar                | 9 — Direct Tune To A Radio Station |
| 4 — View Small Navigation Map | 10 — Seek Down                     |
| 5 — HD Radio                  | 11 — Browse And Manage Presets     |
| 6 — Main Category Bar         | 12 — Radio Bands                   |

- To access the Radio mode, press the “Radio” button on the touchscreen.

### Selecting Radio Stations

- Press the desired radio band (AM, FM or SXM) button on the touchscreen.

### Seek Up/Seek Down

- Press the Seek up or down arrow buttons on the touchscreen for less than two seconds to seek through radio stations.
- Press and hold either arrow button on the touchscreen for more than two seconds to bypass stations without stopping. The radio will stop at the next listenable station once the arrow button on the touchscreen is released.

### **Direct Tune**

- Tune directly to a radio station by pressing the “Tune” button on the screen, and entering the desired station number.

### **Store Radio Presets Manually**

Your radio can store 36 total preset stations, 12 presets per band (AM, FM and SXM). They are shown at the top of your radio screen. To see the 12 preset stations per band, press the arrow button on the touchscreen at the top right of the screen to toggle between the two sets of six presets.

To store a radio preset manually, follow the steps below:

1. Tune to the desired station.
2. Press and hold the desired numbered button on the touchscreen for more than two seconds or until you hear a confirmation beep.

### **HD Radio — If Equipped**

- HD Radio (available on Uconnect 8.4AN) operates similar to conventional radio except it allows broadcasters to transmit a high-quality digital signal.
- With an HD radio receiver, the listener is provided with a clear sound that enhances the listening experience. HD radio can also transmit data such as song title or artist.

### **SiriusXM Premier Over 160 Channels**

Get every channel available on your satellite radio, and enjoy all you want, all in one place. Hear commercial-free music plus sports, news, talk and entertainment. Get all the premium programming, including Howard Stern, every NFL game, Oprah Radio, every MLB and NHL game, every NASCAR race, Martha Stewart and more. And get 20+ extra channels, including SiriusXM Latino, offering 20 channels of commercial free music, news, talk, comedy, sports and more dedicated to Spanish language programming.

- To access SiriusXM Satellite Radio, press the “SXM” button on the touchscreen on the main Radio screen.

The following describes features that are available when in SiriusXM Satellite Radio mode:

#### **Seek Up/Seek Down**

- Press the Seek arrow buttons on the touchscreen for less than two seconds to seek through channels in SXM mode.
- Press and hold either arrow button on the touchscreen for more than two seconds to bypass channels without stopping. The radio will stop at the next listenable channel once the arrow button on the touchscreen is released.

## Direct Tune

- Tune directly to a SXM channel by pressing the “Tune” button on the touchscreen on the screen, and entering the desired station number.

## Jump

- Automatically tells you when Traffic & Weather for a favorite city is available, and gives you the option to switch to that channel. Press “Jump” to activate the feature. After listening to Traffic and Weather, press “Jump” again to return to the previous channel.

## Fav

- Activates the favorites menu. You can add up to 50 favorite artists or songs. Just press “Add Fav Artist” or “Add Fav Song” while the song is playing. You will then be alerted any time one of these songs, or works by these artists, is playing on other SiriusXM channels.

## Album Art

- When arriving at a station, the Channel Art will be displayed to the left of the station information. After 5 seconds the Channel Art will be replaced with the Album Art (if available).

## SiriusXM Parental Controls

- You can skip or hide certain channels from view if you do not want access to them. Press the “Apps” button on the touchscreen, then the “Settings” button on the touchscreen, next press the “Sirius Setup” button on the touchscreen, then select Channel Skip. Press the box check-mark next to the channel you want skipped. They will not show up in normal usage.
- SiriusXM also offers the option to permanently block selected channels. Call (1-888-601-6297 for U.S. customers, 1-877-438-9677 for Canadian customers) and request the Family-Friendly Package.

## Browse

Lets you browse the SiriusXM channel listing or Genre listing. Favorites, Game Zone, Weather and Jump settings also provide a way to browse the SiriusXM channel list.

<b>Browse Sub-Menu</b>	<b>Sub-Menu Description</b>
All	Shows the channel listing.
Genre	Provides a list of all genres, and lets you jump to a channel within the selected genre.
Presets	Lets you scroll the list of Preset satellite channels. Press the channel, or press Enter on the Tune knob, to go to that channel. Press the trash can icon to delete a preset. Your presets are also shown at the top of the main Satellite Radio screen.

Browse Sub-Menu	Sub-Menu Description
Favorites	Lets you manage artists and songs in the Favorites list and configure Alert Settings to let you know when favorite songs or artists are playing on other channels. Also, view a list of channels airing any of your Favorites.
Game Zone	Provides alerts when your favorite sports teams are starting a game which is being aired on other SiriusXM channels, or when their game score is announced. You can select and manage your Teams list here, and configure alerts.
Jump	Lets you select your favorite cities for Traffic & Weather information, which is used by the Jump feature on the main satellite radio screen.

### Replay

Lets you replay up to 44 minutes of the content of the current SiriusXM channel.

Replay Option	Option Description
Play/Pause	Press to Pause content playback. Press Pause/Play again to resume playback.
Rewind/RW	Rewinds the channel content in steps of five seconds. Press and hold to rewind continuously, then release to begin playing content at that point.
Fast Forward/FW	Forwards the content, and works similarly to Rewind/RW. However, Fast Forward/FW can only be used when content has been previously rewind.
Replay Time	Displays the amount of time in the upper center of the screen by which your content lags the Live channel.
Live	Resumes playback of Live content at any time while replaying rewind content.

- SiriusXM services require subscriptions, sold separately after the 12-month trial included with the new vehicle purchase. **If you decide to continue your service at the end of your trial subscription, the plan you choose will automatically renew and bill at then-current rates until you call SiriusXM at 1-866-635-2349 for U.S. residents and 1-888-539-7474 for Canadian residents to cancel. See SiriusXM Customer Agreement for complete terms at [www.siriusxm.com](http://www.siriusxm.com) (U.S. residents) or [siriusxm.ca](http://siriusxm.ca) (Canadian residents).** All fees and programming subject to change. Our satellite service is available only to those at least 18 and older in the 48 contiguous USA and D.C. Our Sirius satellite service is also available in PR (with coverage limitations). Our Internet radio service is available throughout our satellite service area and in AK and HI. ©2015 Sirius XM Radio Inc. Sirius, XM and all related marks and logos are trademarks of Sirius XM Radio Inc.

## Disc Operation (If Equipped)

- Your vehicle may have a remote CD player located in the lower center console storage bin, or in the lower center bench seat bin.
- CD/Disc Mode is entered by either inserting a CD/Disc or by pressing the MEDIA button. Once in Media Mode, select “Disc.”
- Gently insert one CD into the CD player with the CD label facing as indicated on the illustration located on the Disc player.

## Seek Up/Down Buttons

- Press to seek through Disc tracks.
- Hold either button to bypass tracks without stopping.

## Browse

- Press the “Browse” button on the touchscreen to scroll through and select a desired track on the Disc. Press the “Exit” button on the touchscreen if you wish to cancel the browse function.

## MEDIA HUB — USB/Audio Jack (AUX)/SD CARD — If Equipped

There are many ways to play music from MP3 players, USB devices, or SD Cards through your vehicle's sound system. Press your Media button on the touchscreen to begin.

### Audio Jack (AUX)

- The AUX allows a device to be plugged into the radio and utilize the vehicle's sound system, using a 3.5 mm audio cable, to amplify the source and play through the vehicle speakers.
- Pressing the “AUX” button on the touchscreen will change the mode to auxiliary device if the audio jack is connected, allowing the music from your device to be heard through the vehicle's speakers. To activate the AUX, plug in the audio jack.
- The functions of the device are controlled using the device buttons. The volume may be controlled using the radio or device.
- To route the audio cable out of the center console, use the access cut out in the front of the console.

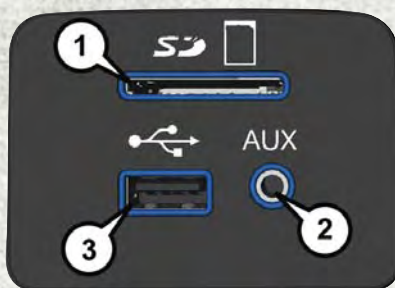

Uconnect Media Hub

- 1 — SD Card Port
- 2 — Audio/AUX Jack
- 3 — USB Port



## USB Port

- Connect your compatible device using a USB cable into the USB Port. USB Memory sticks with audio files can also be used. Audio from the device can be played on the vehicles sound system while providing metadata (artist, track title, album, etc.) information on the radio display.
- When connected, the compatible USB device can be controlled using the radio or Steering Wheel Audio Controls to play, skip to the next or previous track, browse, and list the contents.
- The battery charges when plugged into the USB port (if supported by the specific device).
- To route the USB cable out of the center console, use the access cut out.

### NOTE:

When connecting your device for the first time, the system may take several minutes to read your music, depending on the number of files. For example, the system will take approximately five minutes for every 1,000 songs loaded on the device. Also during the reading process, the Shuffle and Browse functions will be disabled. This process is needed to ensure the full use of your features and only happens the first time it is connected. After the first time, the reading process of your device will take considerably less time unless changes are made or new songs are added to the playlist.

## SD Card

- Play songs stored on an SD card inserted into the SD card slot.
- Song playback can be controlled using the radio or Steering Wheel Audio Controls to play, skip to the next or previous track, browse, and list the contents.

## Bluetooth Streaming Audio

- If equipped with Uconnect Voice Command, your Bluetooth-equipped device may also be able to stream music to your vehicle's sound system. Your connected device must be Bluetooth-compatible and paired with your system (see Uconnect Phone for pairing instructions). You can access the music from your connected Bluetooth device by pressing the Bluetooth  button on the touchscreen while in Media mode.

## Media Controls



### Media Controls

- |                             |  |
|-----------------------------|--|
| 1 — Repeat Music Track      | 5 — Show Songs Currently In Cue To Be Played |
| 2 — Music Track And Time    | 6 — Browse Music By                          |
| 3 — Shuffle Music Tracks    | 7 — Music Source                             |
| 4 — Music Track Information |  |

The controls are accessed by pressing the desired button on the touchscreen and choosing between Disc, AUX, USB, Bluetooth or SD Card.

#### NOTE:

Uconnect will automatically switch to the appropriate mode when something is first connected or inserted into the system.

## Navigation

- The information in the section below is only applicable if you have the 8.4AN system or the Navigation has been activated on your 8.4A system.
- If you have a Uconnect 8.4A system your radio is “Navigation-Ready,” and can be equipped with Navigation at an extra cost. Please see your dealer for details.

Press the “Nav” button on the touchscreen in the menu bar to access the Navigation system.

### Changing The Navigation Voice Prompt Volume

1. Press the “View Map” button on the touchscreen from the Nav Main Menu.
2. With the map displayed, press the “Settings” button on the touchscreen in the lower right area of the screen.
3. In the Settings menu, press the “Guidance” button on the touchscreen.
4. In the Guidance menu, adjust the Nav Volume by pressing the “+” or “-” buttons on the touchscreen.



### Uconnect 8.4AN Navigation

- 1 — Find A Destination
- 2 — View Map
- 3 — Information
- 4 — Emergency

- 5 — Navigation Settings
- 6 — Stop A Route
- 7 — Detour A Route
- 8 — Repeat Route Guidance Prompt

## Finding Points Of Interest

- From the main Navigation menu, press the “Where To?” button on the touchscreen, then press the “Points of Interest” button on the touchscreen.
- Select a Category and then a subcategory, if necessary.
- Select your destination and press the “Yes” button on the touchscreen.

## Finding A Place By Spelling The Name

- From the Main Navigation Menu press the “Where to?” button on the touchscreen, press the “Points of Interest” button on the touchscreen, then press the “Spell Name” button on the touchscreen.
- Enter the name of your destination.
- Press the “List” button on the touchscreen.
- Select your destination and press the “Yes” button on the touchscreen.

## One-Step Voice Destination Entry

- Enter a navigation destination without taking your hands off the wheel.
- Just push the Uconnect Voice Command  button on the steering wheel, wait for the beep and say something like, “**Find Address** 800 Chrysler Drive Auburn Hills MI.”

### NOTE:

Destination entry is not available while your vehicle is in motion. However, you can also use Voice Commands to enter an address while moving. Refer to Common Navigation Voice Commands in the Uconnect Voice Command section.

## Setting Your Home Location

- Press the “Nav” button on the touchscreen in the menu bar to access the Navigation system and the Main Navigation menu.
- Press the “Where To?” button on the touchscreen, then press the “Go Home” button on the touchscreen.
- You may enter your address directly, use your current location as your home address, or choose from recently found locations.
- To delete your Home location (or other saved locations) so you can save a new Home location, press the “Where To?” button on the touchscreen from the Main Navigation menu, then press the “Go Home” button on the touchscreen, and in the Yes screen press the “Options” button on the touchscreen. In the Options menu press the “Clear Home” button on the touchscreen. Set a new Home location by following the previous instructions.

## Go Home

- A Home location must be saved in the system. From the Main Navigation menu, press the “Where To?” button on the touchscreen, then press the “Go Home” button on the touchscreen.



Uconnect 8.4AN Map

- |                               |                                |
|-------------------------------|--------------------------------|
| 1 — Distance To Next Turn     | 5 — Your Location On The Map   |
| 2 — Next Turn Street          | 6 — Navigation Main Menu       |
| 3 — Estimated Time Of Arrival | 7 — Current Street Location    |
| 4 — Zoom In And Out           | 8 — Navigation Routing Options |

Your route is marked with a blue line on the map. If you depart from the original route, your route is recalculated. A speed limit icon could appear as you travel on major roadways.

## Adding A Stop

- To add a stop you must be navigating a route.
- Press the “Menu” button on the touchscreen to return to the Main Navigation menu.
- Press the “Where To?” button on the touchscreen, then search for the extra stop. When another location has been selected, you can choose to cancel your previous route, add as the first destination or add as the last destination.
- Press the desired selection and press the “Yes” button on the touchscreen.

## Taking A Detour

- To take a detour you must be navigating a route.
- Press the “Detour” button on the touchscreen.

### NOTE:

If the route you are currently taking is the only reasonable option, the device may not calculate a detour. For more information, see your Uconnect User's Manual.

## SiriusXM Traffic (8.4AN & US Market Only)

### Don't Drive Through Traffic. Drive Around It.

Avoid congestion before you reach it. By enhancing your vehicle's navigation system with the ability to see detailed traffic information, you can pinpoint traffic incidents, determine average traffic speed and estimate travel time along your route. Since the service is integrated with a vehicle's navigation system, SiriusXM Traffic can help drivers pick the fastest route based on traffic conditions.

- Detailed information on traffic speed, accidents, construction, and road closings.
- Traffic information from multiple sources, including police and emergency services, cameras and road sensors.
- Coast-to-coast delivery of traffic information.
- View conditions for points along your route and beyond. Available in over 130 markets.

## SiriusXM Travel Link (8.4AN & US Market Only)

In addition to delivering over 130 channels of the best sports, entertainment, talk, and commercial-free music, SiriusXM offers premium data services that work in conjunction with compatible navigation systems. SiriusXM Travel Link brings a wealth of useful information into your vehicle and right to your fingertips.

- **Fuel Prices** — Check local gas and diesel prices in your area and route to the station of your choice.
- **Movie Listings** — Check local movie theatres and listings in your area and route to the theater of your choice.
- **Sports Scores** — In-game and final scores as well as weekly schedules.
- **Weather** — Check variety of local and national weather information from radar maps to current and 5-day forecast.

SiriusXM Travel Link feature is completely integrated into your vehicle. A few minutes after you start your vehicle, Travel Link information arrives and updates in the background. You can access the information whenever you like, with no waiting.

To access SiriusXM Travel Link, press “Apps” button on the touchscreen, then press the “SiriusXM Travel Link” button on the touchscreen.

**NOTE:**

SiriusXM Travel Link requires a subscription, sold separately after the five (5) year trial subscription included with your vehicle purchase.

SiriusXM Travel Link is only available in the United States.

<b>Fuel Prices</b>	Check local gas and diesel prices in your area and route to the station of your choice.
<b>Movie Listings</b>	Check local movie theatres and listings in your area and route to the theater of your choice.
<b>Sports Scores</b>	In-game and final scores as well as weekly schedules.
<b>Weather</b>	Check variety of local and national weather information from radar maps to current and 5-day forecast.

## UCONNECT 8.4A/8.4AN VOICE RECOGNITION QUICK TIPS

### Introducing Uconnect

Start using Uconnect Voice Recognition with these helpful quick tips. It provides the key Voice Commands and tips you need to know to control your Uconnect 8.4AN system.

If you see the  icon on your touchscreen, you have the Uconnect 8.4AN system. If not, you have a Uconnect 8.4A system.



Uconnect 8.4AN



## Get Started

1. U.S. residents can visit **UconnectPhone.com** to check device and feature compatibility and to find device pairing instructions.
2. Reduce background noise. Wind and passenger conversations are examples of noise that may impact recognition.
3. Speak clearly at a normal pace and volume while facing straight ahead. The microphone is positioned on the rearview mirror and aimed at the driver.
4. Each time you give a Voice Command, you must first push either the VR or Phone button, wait until **after** the beep, then say your Voice Command.
5. You can interrupt the help message or system prompts by pushing the VR or Phone button and saying a Voice Command from current category.

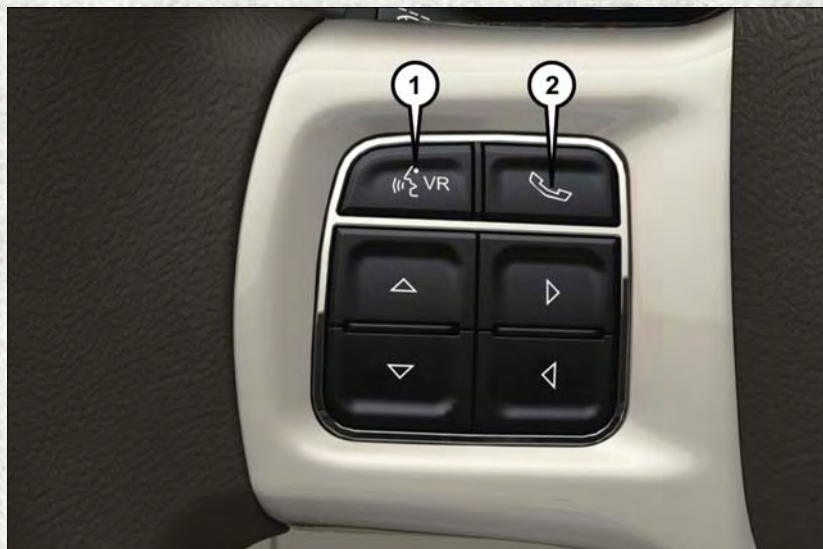
All you need to control your Uconnect system with your voice are the buttons on your steering wheel.



**Uconnect VR And Phone Buttons**

1. Uconnect Voice Recognition Button  .
  - a. Short Press: **Push and release** the VR button to begin Radio, Climate, Navigation, and other embedded functions. After you hear the single beep, say a command.
  - b. Long Press: **Push and hold, then release** the VR button for Siri functions. After you hear the familiar Siri "double beep," say a command.
2. Uconnect Phone Button  , Push to initiate, answer, or end a phone call, send or receive a text.



## Basic Voice Commands

The basic Voice Commands below can be given at any point while using your Uconnect system.

Push the VR button . After the beep, say:

- **Cancel** to stop a current voice session
- **Help** to hear a list of suggested Voice Commands
- **Repeat** to listen to the system prompts again

Notice the visual cues that inform you of your voice recognition system's status. Cues appear on the touchscreen.



Uconnect 8.4A/8.4AN

# ELECTRONICS

## Radio

Use your voice to quickly get to the AM, FM or SiriusXM Satellite Radio stations you would like to hear. (Subscription or included SiriusXM Satellite Radio trial required.)

Push the VR button . After the beep, say:

- **Tune to** ninety-five-point-five FM
- **Tune to** Satellite Channel Hits 1

**TIP:** At any time, if you are not sure of what to say or want to learn a Voice Command, push the VR button  and say **“Help.”** The system will provide you with a list of commands.



Uconnect 8.4A/8.4AN Radio

## Media

Uconnect offers connections via USB, SD, Bluetooth and auxiliary ports (If Equipped). Voice operation is only available for connected USB and iPod devices.

Push the VR button . After the beep, say one of the following commands and follow the prompts to switch your media source or choose an artist.

- **Change source** to Bluetooth
- **Change source** to iPod
- **Change source** to USB
- **Play artist** Beethoven; **Play album** Greatest Hits; **Play song** Moonlight Sonata; **Play genre** Classical

**TIP:** Press the Browse button on the touchscreen to see all of the music on your iPod or USB device. Your Voice Command must match **exactly** how the artist, album, song and genre information is displayed.



Uconnect 8.4A/8.4AN Media

# ELECTRONICS

## Phone

Making and answering hands-free phone calls is easy with Uconnect. When the Phonebook button is illuminated on your touchscreen, your system is ready.

U.S. residents can visit:

- [UconnectPhone.com](http://UconnectPhone.com) for device compatibility and pairing instructions.

Canadian residents can visit:

- [UconnectPhone.com](http://UconnectPhone.com) for device compatibility and pairing instructions.

Push the Phone button. After the beep, say one of the following commands...

- **Call** John Smith
- **Dial** 123-456-7890 and follow the system prompts
- **Redial** (call previous outgoing phone number)
- **Call back** (call previous incoming phone number)

**TIP:** When providing a Voice Command, push the Phone button and say **"Call,"** then pronounce the name **exactly** as it appears in your phone book. When a contact has multiple phone numbers, you can say **"Call John Smith work."**



Uconnect 8.4A/8.4AN Phone

## Siri Eyes Free — If Equipped

Siri lets you use your voice to send text messages, select media, place phone calls and much more. Siri uses your natural language to understand what you mean and will respond back to confirm your requests. The system is designed to keep your eyes on the road and your hands on the wheel by letting Siri help you perform useful tasks.

To enable Siri push and hold, then release the Uconnect Voice Recognition (VR) button on the steering wheel. After you hear a double beep you can ask Siri to play podcasts and music, get directions, read text messages and many other useful requests.



Siri Eyes Free Available

## Getting Started

Ensure Siri is enabled on your iPhone.



### Enable Siri

- 1 — Select Settings on your iPhone  
2 — Select General
- 3 — Select Siri  
4 — Enable Siri

1. Pair your Siri enabled device to the vehicle's sound system. Refer to "Uconnect Phone" in "Electronics" for a detailed pairing procedure.



### Pair Your iPhone

2. Push and Hold, then release the Uconnect Voice Recognition (VR) button (Ⓜ️ VR on the steering wheel. After you hear the familiar Siri "double beep," say a command.

**NOTE:**

A **push and release** of the Ⓜ️ VR button will start normal embedded VR functions. The **push and hold, then release** of the Ⓜ️ VR button will start Siri functions.



3. After the double beep, begin speaking to Siri.

Examples of Siri commands and questions:

- "Play Rolling Stones"
- "Send text message to John"
- "Read text message from Sarah"
- "Take me to the nearest coffee shop"

**NOTE:**

- Speak clearly at a normal pace and volume while facing straight ahead to ensure your command is understood.
- Siri is available on iPhone 4S and later.



Siri Eyes Free

## Voice Text Reply

Uconnect will announce **incoming** text messages. Push the Phone button  and say **Listen**. (Must have compatible device paired to Uconnect system.)

1. Once an incoming text message is read to you, push the Phone button . After the beep, say: **Reply**.
2. Listen to the Uconnect prompts. After the beep, repeat one of the pre-defined messages and follow the system prompts.

PRE-DEFINED VOICE TEXT REPLY RESPONSES		
Yes.	Stuck in Traffic.	See you later.
No.	Start without me.	I'll be Late.
Okay.	Where are you?	I will be <number> minutes late.
Call me.	Are you there yet?	
I'll call you later.	I need directions.	See you in <number> minutes.
I'm on my way.	Can't talk right now.	Thanks.
I'm lost.		

**TIP:** Your device must have the full implementation of the **Message Access Profile (MAP)** to take advantage of this feature. For details about MAP, visit [UconnectPhone.com](http://UconnectPhone.com) for U.S. residents. Apple iPhone iOS6 or later supports reading **incoming** text messages only. To enable this feature on your Apple iPhone, follow these 4 simple steps:

1. Select "Settings."
2. Select "Bluetooth."
3. Select the (i) for the paired vehicle.
4. Turn on "Show Notifications."

**TIP:** Voice Text Reply is not compatible with iPhone, but if your vehicle is equipped with Siri Eyes Free, you can use your voice to send a text message.



iPhone Notification Setting



## Climate (8.4A/8.4AN)

Too hot? Too cold? Adjust vehicle temperatures hands-free and keep everyone comfortable while you keep moving ahead. (If vehicle is equipped with climate control.)

Push the VR button . After the beep, say one of the following commands:

- **Set driver temperature to 70 degrees**
- **Set passenger temperature to 70 degrees**

**TIP:** Voice Command for Climate may only be used to adjust the interior temperature of your vehicle. Voice Command will not work to adjust the heated seats or steering wheel (if equipped).





Uconnect 8.4A/8.4AN Climate

# ELECTRONICS

## Navigation (8.4A/8.4AN)

The Uconnect navigation feature helps you save time and become more productive when you know exactly how to get to where you want to go. (Navigation is optional on the Uconnect 8.4A system. See your dealer to activate navigation at any time.)

1. To enter a destination, push the VR button . After the beep, say:
  - For the 8.4A Uconnect System, say: **Enter state**.
  - For the 8.4AN Uconnect System, say: **Find Address** 800 Chrysler Drive Auburn Hills, Michigan.
2. Then follow the system prompts.

**TIP:** To start a Point Of Interest (POI) search, push the VR button . After the beep, say "**Find nearest** coffee shop."



Uconnect 8.4A/8.4AN Navigation

## Uconnect Access — If Equipped (8.4A/8.4AN)

### WARNING!

ALWAYS obey traffic laws and pay attention to the road. Some Uconnect Access services, including 9-1-1 and Assist, will NOT work without an operable 1X (voice/data) or 3G (data) network connection.

#### NOTE:

Your vehicle may be transmitting data as authorized by the subscriber.

An included trial and/or subscription is required to take advantage of the Uconnect Access services in the next section of this guide. To register with Uconnect Access, press the “Apps” button on the 8.4-inch touchscreen to get started. Detailed registration instructions can be found on the next page.

#### NOTE:



- If your vehicle is not connected to an operable 1X (voice/data) or 3G (data) network, the signal strength bars on the “Apps” button on the touchscreen will show a single bar and a prohibition symbol to indicate your vehicle is not connected to an operable 1X (voice/data) or 3G (data) network.

- Uconnect Access is available only on properly equipped vehicles purchased within the continental United States, Alaska and Hawaii when connected to an operable 1X (voice/data) or 3G (data) network. Services can only be used where coverage is available; see coverage map for details.

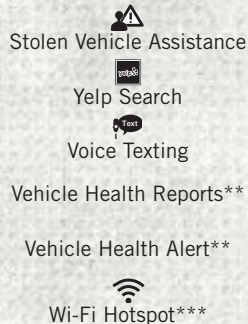
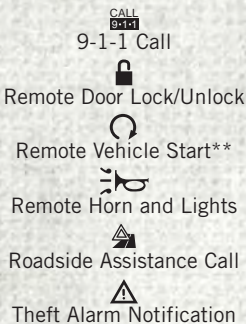

\*\*If vehicle is properly equipped.

\*\*\*Extra charges apply.

## Register (8.4A/8.4AN)

To unlock the full potential of Uconnect Access in your vehicle, you first need to register with Uconnect Access.

1. Push the ASSIST button on your rearview mirror.



### Uconnect 8.4 Registration

2. Press the “Uconnect Care” button on the touchscreen.
3. A helpful Uconnect Care Agent will register your vehicle and handle all of the details.

**Signing up is easy!** Simply follow the steps above. Or, press the “Apps  ” button on the touchscreen, then select the Uconnect registration app to “Register By Web” to complete the process using your device or computer.

For further information please visit [www.driveuconnect.com](http://www.driveuconnect.com)

## Mobile App (8.4A/8.4AN)

You're only a few steps away from using remote commands and playing your favorite music in your vehicle.

To link your internet radio accounts:

1. Download the **Uconnect Access App** on your device.
2. Press the Via Mobile icon on the navigation bar at the bottom of the app.
3. Press the app you'd like to connect to your vehicle.
4. Enter your login information for the selected app and press Link.
5. Next time you're in your vehicle, enable Bluetooth, pair your device and select the Via Mobile app you want to play from the Uconnect touchscreen to stream your personalized music.

### NOTE:

- You can also complete this process on the web. Simply visit [moparownerconnect.com](http://moparownerconnect.com) log in and click **Set Up Via Mobile Profile** (under Quick Links).
- Once you download the app to your compatible device, you will also be able to start your vehicle and lock/unlock its doors from virtually anywhere.



Mobile App

## Voice Texting (8.4A/8.4AN)

You must be registered with Uconnect Access and have a compatible MAP – enabled device to use your voice to send a personalized text message. (Not compatible with iPhone.)

1. To send a message, push the Phone button . After the beep, say: “**Send message** to John Smith.”
2. Listen to the prompt. After the beep, dictate the message you would like to send. Wait for Uconnect to process your message.
3. The Uconnect system will repeat your message and provide a variety of options to add to, delete, send or hear the message again. After the beep, tell Uconnect what you’d like to do. For instance, if you’re happy with your message, after the beep, say “**Send.**”

You must be registered with Uconnect Access and have a compatible MAP – enabled device to use your voice to send a personalized text message. For details about MAP, visit [UconnectPhone.com](http://UconnectPhone.com). Apple iPhone iOS6 or later supports reading incoming text messages only. To enable this feature on your Apple iPhone, follow these 4 simple steps:

1. Select “Settings.”
2. Select “Bluetooth.”
3. Select the (i) for the paired vehicle.
4. Turn on “Show Notifications.”

### TIP:



- Voice Texting is not compatible with iPhone, but if your vehicle is equipped with Siri Eyes Free, you can use your voice to send a text message.
- Messages are limited to 140 characters.
- The Messaging button on the touchscreen must be illuminated to use the feature.



iPhone Notification Setting

## Yelp (8.4A/8.4AN)

Once registered with Uconnect Access, you can use your voice to search for the most popular places or things around you.

1. Push the VR button . After the beep, say: **Launch YELP.**
2. Once the YELP home screen appears on the touchscreen, push the VR button , then say: **YELP search.**
3. Listen to the system prompts and after the beep, tell Uconnect the place or business that you'd like Uconnect to find.

**TIP:** Once you perform a search, you can reorganize the results by selecting either the Best Match, Rating or Distance tab on the top of the touchscreen display.



Yelp

## SiriusXM Travel Link (8.4A/8.4AN — US Market Only)

Need to find a gas station, view local movie listings, check a sports score or the 5 - day weather forecast? SiriusXM Travel Link is a suite of services that brings a wealth of information right to your Uconnect 8.4AN system. (Not available for 8.4A system.)

Push the VR button . After the beep, say one of the following commands:

- Show fuel prices
- Show 5 - day weather forecast
- Show extended weather

**TIP:** Traffic alerts are not accessible with Voice Command.



SiriusXM Travel Link



## Additional Information

© 2015 FCA US LLC. All rights reserved. Mopar, Mopar Owner Connect and Uconnect are registered trademarks of FCA US LLC. Android is a trademark of Google Inc. SiriusXM and all related marks and logos are trademarks of SiriusXM Radio Inc. Yelp, Yelp logo, Yelp burst and related marks are registered trademarks of Yelp.

Uconnect System Support:

- U.S. residents visit [DriveUconnect.com](http://DriveUconnect.com) or call: 1-877-855-8400 (24 hours a day 7 days a week)
- Canadian residents visit [DriveUconnect.ca](http://DriveUconnect.ca) or call: 1-800-465-2001 (English) or 1-800-387-9983 (French)

Mon. – Fri., 8:00 am – 8:00 pm, ET

Sat., 9:00 am – 5:00 pm, ET

Sun., Closed

Uconnect Access Services Support: 1-855-792-4241. Please have your Uconnect Security PIN ready when you call.

## UCONNECT PHONE

### Uconnect Phone (Bluetooth Hands Free Calling)



Uconnect 5.0 Phone Menu

- |   |  |
|---|--|
| 1 — Call/Redial/Hold                    | 7 — Uconnect Phone Settings Menu         |
| 2 — Mobile Phone Signal Strength        | 8 — Text Messaging                       |
| 3 — Currently Paired Mobile Phone       | 9 — Direct Dial Pad                      |
| 4 — Mobile Phone Battery Life           | 10 — Recent Call Log                     |
| 5 — Mute Microphone                     | 11 — Browse Phone Book<br>(Contains 911) |
| 6 — Transfer To/From Uconnect<br>System | 12 — End Call                            |



**Uconnect 8.4A/8.4AN Phone Menu**

- |   |   |
|---|---|
| 1 — Favorite Contacts                   | 12 — Browse Phone Book Entries<br>(Contains 9-1-1)  |
| 2 — Mobile Phone Battery Life           | 13 — End Call   |
| 3 — Currently Paired Mobile Phone       | 14 — Call/Redial/Hold   |
| 4 — Mobile Phone Signal Strength        | 15 — Do Not Disturb   |
| 5 — Mute Microphone                     | 16 — Reply with Text Message  |
| 6 — Transfer To/From Uconnect<br>System | * — Conference call feature only<br>available on GSM mobile devices                                   |
| 7 — Conference Call*                    | ** — Text messaging feature not<br>available on all mobile phones<br>(requires Bluetooth MAP profile) |
| 8 — Manage Paired Mobile Phones         |   |
| 9 — Text Messaging**                    |   |
| 10 — Direct Dial Pad                    |   |
| 11 — Recent Call Log                    |   |

The Uconnect Phone feature enables you to place and receive hands-free mobile phone calls. Drivers can also place mobile phone calls using their voice or by using the buttons on the touchscreen (see Voice Command section).

The hands-free calling feature is made possible through Bluetooth technology — the global standard that enables different electronic devices to connect to each other wirelessly.

If the Uconnect Phone Button exists on your steering wheel, you then have the Uconnect Phone features.

Refer to the “Understanding The Features Of Your Vehicle” section of your vehicle's Owner's Manual on the DVD for further details.

## NOTE:

- The Uconnect Phone requires a mobile phone equipped with the Bluetooth Hands-Free Profile, Version 1.0 or higher.
- Most mobile phones/devices are compatible with the Uconnect system, however some mobile phones/devices may not be equipped with all of the required features to utilize all of the Uconnect system features.
- For Uconnect Customer Care:
  - U.S. residents visit [UconnectPhone.com](http://UconnectPhone.com) or call 1-877-855-8400.
  - Canadian Residents visit [UconnectPhone.com](http://UconnectPhone.com) or call, 1-800-465-2001 (English) or 1-800-387-9983 (French).

## Pairing (Wirelessly Connecting) Your Mobile Phone To The Uconnect System

Mobile phone pairing is the process of establishing a wireless connection between a cellular phone and the Uconnect system.

## NOTE:

- To use the Uconnect Phone feature, you first must determine if your mobile phone and software are compatible with the Uconnect system. Please visit [UconnectPhone.com](http://UconnectPhone.com) for complete mobile phone compatibility information.
- Mobile phone pairing is not available while the vehicle is in motion.
- A maximum of 10 mobile phones can be paired to the Uconnect system.

## Start Pairing Procedure On The Radio

### Uconnect 5.0:

1. Place the ignition in the ACC or ON position.
2. Press the “Phone” button.
3. Select “Settings.”
4. Select “Paired Phones.”
5. Select “Add device.”
  - Uconnect Phone will display an “In progress” screen while the system is connecting.



Uconnect 5.0

**Uconnect 8.4A, 8.4AN:**

1. Place the ignition in the ACC or ON position.
2. Press the "Phone" button in the Menu Bar on the touchscreen.
3. Select "Settings."
4. Select "Paired Phones."
5. Select "Add device."
  - Uconnect Phone will display an "In progress" screen while the system is connecting.

**Uconnect 8.4A & 8.4AN****Pair Your iPhone:**

To search for available devices on your Bluetooth enabled iPhone:

1. Press the Settings button.
2. Select Bluetooth.
  - Ensure the Bluetooth feature is enabled. Once enabled, the mobile phone will begin to search for Bluetooth connections.
3. When your mobile phone finds the Uconnect system, select "Uconnect".

**Bluetooth On/Uconnect Device****Complete The iPhone Pairing Procedure:**

1. When prompted on the mobile phone, accept the connection request from Uconnect Phone.

**NOTE:**

Some mobile phones will require you to enter the PIN number.

**Pairing Request**

## Select The iPhone's Priority Level

When the pairing process has successfully completed, the system will prompt you to choose whether or not this is your favorite mobile phone. Selecting "Yes" will make this mobile phone the highest priority. This mobile phone will take precedence over other paired mobile phones within range and will connect to the Uconnect system automatically when entering the vehicle. Only one mobile phone and/or one Bluetooth audio device can be connected to the Uconnect system at a time. If "No" is selected, simply select "Uconnect" from the mobile phone/audio device Bluetooth screen, and the Uconnect system will reconnect to the Bluetooth device.

## Pair Your Android Device:

To search for available devices on your Bluetooth enabled Android Device:

1. Push the Menu button.
2. Select Settings.
3. Select Connections.
4. Turn Bluetooth setting to "On."
  - Ensure the Bluetooth feature is enabled. Once enabled, the mobile phone will begin to search for Bluetooth connections.
5. Once your mobile phone finds the Uconnect system, select "Uconnect".
  - You may be prompted by your mobile phone to download the phonebook, check "Do Not Ask Again" to automatically download the phonebook. This is so you can make calls by saying the name of your contact.



Uconnect Device

## Complete The Android Pairing Procedure:

1. Confirm the passkey shown on the mobile phone matches the passkey shown on the Uconnect system then accept the Bluetooth pairing request.

### NOTE:

Some mobile phones require the PIN to be entered manually, enter the PIN number shown on the Uconnect screen.

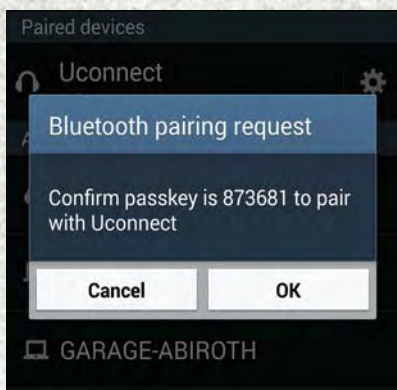

Pairing Request

## Select The Android Mobile Phone's Priority Level

When the pairing process has successfully completed, the system will prompt you to choose whether or not this is your favorite mobile phone. Selecting “Yes” will make this mobile phone the highest priority. This mobile phone will take precedence over other paired mobile phones within range and will connect to the Uconnect system automatically when entering the vehicle. Only one mobile phone and/or one Bluetooth audio device can be connected to the Uconnect system at a time. If “No” is selected, simply select “Uconnect” from the mobile phone/audio device Bluetooth screen, and the Uconnect system will reconnect to the Bluetooth device.

You are now ready to make hands-free calls. Press the Uconnect “Phone” button on your steering wheel to begin.

### NOTE:

Refer to [UconnectPhone.com](http://UconnectPhone.com) website for additional information on mobile phone pairing and for a list of compatible phones.

## Common Phone Commands (Examples)

- “Call John Smith”
- “Call John Smith mobile”
- “Dial 1 248 555 1212”
- “Redial”

## Mute (Or Unmute) Microphone During Call

- During a call, press the “Mute” button on the Phone main screen to mute and unmute the call.

## Transfer Ongoing Call Between Handset And Vehicle

- During an on-going call, press the “Transfer” button on the Phone main screen to transfer an on-going call between handset and vehicle.

## Phonebook

The Uconnect system will automatically sync your phonebook from your paired phone, if this feature is supported by your phone. Phonebook contacts are updated each time that the phone is connected. If your phone book entries do not appear, check the settings on your phone. Some phones require you to enable this feature manually.

- Your phonebook can be browsed on the Uconnect system touchscreen, but editing can only be done on your phone. To browse, press the “Phone” button on the touchscreen, then the “Phonebook” button on the touchscreen.

Favorite phonebook entries can be saved as Favorites for quicker access. Favorites are shown at the top of the main phone screen.



## Voice Command Tips

- Speaking complete names (i.e; Call John Doe vs. Call John) will result in greater system accuracy.
- You can “link” commands together for faster results. Say “Call John Doe, mobile,” for example.
- If you are listening to available voice command options, you do not have to listen to the entire list. When you hear the command that you need, push the  VR button on the steering wheel, wait for the beep and say your command.

## Changing The Volume

- Start a dialogue by pushing the Phone button , then say a command for example - "Help".
- Use the radio VOLUME/MUTE rotary knob to adjust the volume to a comfortable level while the Uconnect system is speaking. Please note the volume setting for Uconnect is different than the audio system.

### NOTE:

To access help, push the Uconnect Phone button  on the steering wheel and say "help." Push the Uconnect Phone Pickup button  or the VR button  and say "cancel" to cancel the help session.

## Using Do Not Disturb

With Do Not Disturb, you can disable notifications from incoming calls and texts, allowing you to keep your eyes on the road and hands on the wheel. For your convenience there is a counter display to keep track of your missed calls and text messages while you were using Do Not Disturb.

Do Not Disturb can automatically reply with a text message, a call or both, when declining an incoming call and send it to voicemail.

Automatic reply messages can be:

- “I am driving right now, I will get back to you shortly.”
- Create a custom auto reply message up to 160 characters.

While in Do Not Disturb, Conference Call can be selected so you can still place a second call without being interrupted by incoming calls.

### NOTE:

- Only the beginning of your custom message will be seen on the touchscreen.
- Reply with text message is not compatible with iPhones.
- Auto reply with text message is only available on phones that supporting Bluetooth MAP.



## Incoming Text Messages

After pairing your Uconnect system with a Bluetooth enabled mobile device with the Message Access Profile (MAP), the Uconnect system can announce a new incoming text message and read it to you over the vehicle's audio system.

### NOTE:

Only incoming text messages received during the current ignition cycle can be viewed/read.

To enable incoming text messaging:

### iPhone

1. Press the settings button on the mobile phone.
2. Select Bluetooth.
  - Ensure Bluetooth is enabled, and the mobile phone is paired to the Uconnect system.
3. Select ⓘ located under DEVICES next to Uconnect.
4. Turn "Show Notifications" to On.



**Enable iPhone Incoming Text Messages**

## Android Devices

1. Push the Menu button on the mobile phone.
2. Select Settings.
3. Select Connections.
4. Turn "Show Notifications" to On.
  - A pop up will appear asking you to accept a request for permission to connect to your messages. Select "Don't ask again" and press OK.

### NOTE:

All incoming text messages received during the current ignition cycle will be deleted from the Uconnect system when the ignition is turned to the Off position.

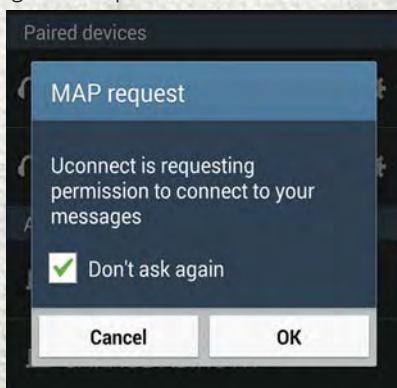

Enable Android Device Incoming Text Messages

## Voice Text Reply (Not Compatible With iPhone)

### NOTE:

Voice texting reply and voice texting features require a compatible mobile device enabled with Bluetooth Message Access Profile (MAP). iPhone, and some other smartphones, may not entirely support Bluetooth MAP. Visit [UconnectPhone.com](http://UconnectPhone.com) for the latest system and device compatibility.

- Due to the extremely large number of mobile phone manufacturers, your mobile device may not be listed. For further assistance, contact Uconnect Customer Care @ 1-877-855-8400 for U.S. residents or, 1-800-465-2001 (English) / 1-800-387-9983 (French) for Canadian residents.

Once your Uconnect system is paired with a compatible mobile device, the system can announce a new incoming text message, and read it to you over the vehicle audio system. You can reply to the message using Voice Recognition by selecting, or saying, one of the 18 pre-defined messages.

**Here's How:**

1. Push the Uconnect Phone button  and wait for the beep, then say "reply." Uconnect will give the following prompt: "Please say the message you would like to send."
2. Wait for the beep and say one of the pre-defined messages. (If you are not sure, you can say "help"). Uconnect will then read the pre-defined messages allowed.
3. As soon as you hear the message you would like to send, you can interrupt the list of prompts by pushing the Uconnect phone button and saying the phrase. Uconnect will confirm the message by reading it back to you.
4. Push the Phone button and say "Send."

**PRE-DEFINED VOICE TEXT REPLY RESPONSES**

Yes.	Stuck in Traffic.	See you later.
No.	Start without me.	I'll be Late.
Okay.	Where are you?	I will be <5, 10, 15,...etc.> minutes late.
Call me.	Are you there yet?	
I'll call you later.	I need directions.	See you in <5, 10, 15,...etc.> of minutes.
I'm on my way.	Can't talk right now.	
I'm lost.		Thanks.

**NOTE:**

To make the SMS voice reading function available, the SMS notification option on phone must be enabled; this option is usually available on the phone, in the Bluetooth connections menu for a device registered as Uconnect. After enabling this function on the mobile phone, it must be disconnected and reconnected with the Uconnect system in order to make it effective.

## Helpful Tips And Common Questions To Improve Bluetooth Performance With Your Uconnect System

### Mobile Phone won't reconnect to system after pairing:

- Set mobile phone to auto-connect or trusted device in mobile phone Bluetooth settings (Blackberry devices).
- Perform a factory reset on your mobile phone. Refer to your mobile phone manufacturer or cellular provider for instructions.
- Many mobile phones do not automatically reconnect after being restarted (hard reboot). Your mobile phone can still be connected manually. Close all applications that may be operating (refer to mobile phone manufacturer's instructions), and follow "Pairing (Wirelessly Connecting) Your Mobile Phone To The Uconnect System".

### Mobile Phone won't pair to system:

- Perform a hard reset in the mobile phone by removing the battery (if removable — see your mobile phone's owner manual).
- Delete pairing history in mobile phone and Uconnect system; usually found in phone's Bluetooth connection settings.
- Verify you are selecting "Uconnect" in the discovered Bluetooth devices on your mobile phone.
- If your vehicle system generates a pin code the default is 0000.

### Mobile Phonebook didn't download:

- Check "Do not ask again," then accept the "phonebook download" request on your mobile phone.
- Up to 5,000 contact names with four numbers per contact will transfer to the Uconnect 8.4A/8.4AN system phonebook.
- Up to 2,000 contact names with six numbers per contact will transfer to the Uconnect 5.0 system phonebook.

### Text messaging won't work:

- Check "Do not ask again," then accept the "connect to your messages" request on your mobile phone.
- Verify that your mobile phone has the Bluetooth feature (Message Access Profile).

### Can't make a conference call:

- CDMA (Code-Division Multiple Access) carriers do not support conference calling. Refer to your mobile phone user's manual for further information.

### Making calls while connected to AUX:

- Plugging in your mobile phone to AUX while connected to Bluetooth will disable Hands-Free Calling. Do not make calls while your mobile phone is plugged into the AUX jack.

## STEERING WHEEL AUDIO CONTROLS

The steering wheel audio controls are located on the rear surface of the steering wheel.

### Right Switch

- Push the switch up or down to increase or decrease the volume.
- Push the button in the center to change modes AM/FM/CD/SXM.

### Left Switch

- Push the switch up or down to search for the next listenable station.
- Push the button in the center to select the next preset station.



Steering Wheel Audio Controls

## ELECTRONIC VEHICLE INFORMATION CENTER (EVIC) OR DRIVER INFORMATION DISPLAY (DID)

The EVIC/DID features an interactive display that is located in the instrument cluster. Pushing the controls on the left side of the steering wheel allows the driver to select vehicle information and Personal Settings. Refer to “EVIC/DID Programmable Features” in this section for further information.

- Push and release the **UP**  $\triangle$  arrow button to scroll upward through the main menus and submenus (Digital Speedometer, Vehicle Info, Fuel Economy Info, Trip A, Trip B, Stop/Start, Trailer Tow, Audio, Stored Messages, Screen Setup, Vehicle Settings).
- Push and release the **DOWN**  $\nabla$  arrow button to scroll downward through the main menus and submenus.
- Push and release the **RIGHT**  $\triangleright$  arrow button for access to main menus, submenus or to select a personal setting in the setup menu. Push and hold the **RIGHT**  $\triangleright$  arrow button for two seconds to reset features.



EVIC/DID Controls

- Push and release the **LEFT**  $\triangleleft$  arrow button to scroll back to a previous menu or submenu.







## Compass Calibration

This compass is self-calibrating, which eliminates the need to set the compass manually. When the vehicle is new, the compass may appear erratic, and the EVIC/DID will display “CAL” until the compass is calibrated.

You may also calibrate the compass by completing one or more 360 degree turns (in an area free from large metal or metallic objects) until the “CAL” message displayed in the EVIC/DID turns off. The compass will now function normally.

## PROGRAMMABLE FEATURES

### EVIC/DID Programmable Features

The EVIC/DID can be used to view or change the following settings. Push the **UP**  or **DOWN**  arrow button until System Setup displays, then push the **RIGHT**  arrow button. Scroll through the settings using the **UP**  or **DOWN**  arrow button. Push the **RIGHT**  arrow button to change the setting. Push the **LEFT**  arrow button to scroll back to a previous menu or sub menu.

- Language Select
- Units
- ParkSense
- Tilt Mirror In Reverse
- Rain Sensing Wipers
- Hill Start Assist
- Headlights Off Delay
- Illuminated Approach
- Headlights On With Wipers
- Automatic Highbeams
- Flash Lights With Lock
- Auto Lock Doors
- Auto Unlock Doors
- Sound Horn With Remote Start
- Sound Horn With Remote Lock
- Remote Unlock Sequence
- Key Fob Linked To Me
- Passive Entry
- Remote Start Comfort System
- Easy Exit Seat
- Key-Off Power Delay
- Commercial Settings
- Air Suspension Display Alerts
- Aero Ride Height Mode
- Tire/Jack Mode
- Transport Mode
- Wheel Alignment Mode
- Horn With Remote Lower
- Lights With Remote Lower
- Trailer Select
- Brake Type
- Trailer Name
- Compass Variance
- Calibrate Compass
- Fuel Saver Display
- Park Assist Front Chime Volume
- Park Assist Rear Chime Volume

## Uconnect Customer Programmable Features

The Uconnect system allows you to access Customer Programmable feature settings such as Display, Voice, Clock, Safety & Driving Assistance, Lights, Doors & Locks, Auto-On Comfort, Engine Off Options, Compass Settings (Uconnect 5.0,) Trailer Brake, Suspension, Audio, Phone/Bluetooth, SiriusXM Setup, Restore Settings, Clear Personal Data, and System Information through buttons on the touchscreen.

- Push the **SETTINGS** button (Uconnect 5.0), or press the “Apps” button (Uconnect 8.4) located near the bottom of the touchscreen, then press the “Settings” button on the touchscreen to access the Settings screen. When making a selection, scroll up or down until the preferred setting is highlighted, then press the preferred setting until a check-mark appears next to the setting, showing that setting has been selected. The following feature settings are available:
  - Display
  - Voice
  - Clock
  - Safety & Driving Assistance
  - Lights
  - Doors & Locks
  - Auto-On Comfort
  - Engine Off Options
  - Trailer Brake
  - Suspension
  - Audio
  - Phone/Bluetooth
  - SiriusXM Setup
  - Restore Settings
  - Clear Personal Data
  - System Information
  - Compass Settings (Uconnect 5.0)

### NOTE:



Depending on the vehicles options, feature settings may vary.

Refer to “Uconnect Settings/Customer Programmable Features” found within “Understanding Your Instrument Panel” located in your Owner’s Manual on the DVD for further information.





## Instrument Cluster Reconfigurable Screen Setup

The following settings allow you to change what information is displayed in the instrument cluster as well as the location that information is displayed.

### Digital Speedometer

- Push the **UP**  or **DOWN**  arrow button until the Digital display icon is highlighted in the EVIC/DID. Push the **RIGHT**  arrow button to change the display between km/h and mph.

## Vehicle Info (Customer Information Features)

- Push the **UP**  or **DOWN**  arrow button until the Vehicle Info icon is highlighted in the EVIC/DID Display. Push the **RIGHT**  or **LEFT**  arrow button to scroll through the following Vehicle Info submenus:
  - Tire Pressure Monitor System
  - Air Suspension — If Equipped
  - Coolant Temperature (Diesel Only)
  - Transmission Temperature (Automatic Transmission Only)
  - Oil Temperature
  - Oil Pressure
  - Oil Life
  - Fuel Filter Life (Diesel Only)
  - Battery Voltage
  - Exhaust Brake (Diesel Only)
  - Turbo Boost (Diesel Only)
  - Gauge Summary
  - Engine Hours



## Trip A

- Push the **UP**  or **DOWN**  arrow button until the Trip A icon is highlighted in the EVIC/DID. Push and hold the **RIGHT**  arrow button to reset the Trip A information.



## Trip B

- Push the **UP**  or **DOWN**  arrow button until the Trip B icon is highlighted in the EVIC/DID. Push and hold the **RIGHT**  arrow button to reset the Trip B information.



## Fuel Economy

- Push the **UP**  or **DOWN**  arrow button until the Fuel Economy icon is highlighted. The screen will display the following:
  - Average Fuel Economy/Miles Per Gallon
  - Range To Empty (RTE)
  - Current Miles Per Gallon (MPG)
  - Dual Tanks- If Equipped (Heavy Duty Only)

## Stop/Start

- Push the **UP**  or **DOWN**  arrow button until the Stop/Start icon is highlighted in the EVIC/DID. Push the **RIGHT**  arrow button to display the Stop/Start status.

## Trailer Tow

- Push the **UP**  or **DOWN**  arrow button until the Trailer Tow icon is highlighted. The screen will display the following information:
  - Trailer Trip Distance



## Audio

- Push the **UP**  $\triangle$  or **DOWN**  $\nabla$  arrow button until the Audio display icon is highlighted in the EVIC/DID. This screen will display the current media source.

## Screen Setup

- Push the **UP**  $\triangle$  or **DOWN**  $\nabla$  arrow button until the Screen Setup display icon is highlighted in the EVIC/DID. Push the **RIGHT**  $\triangleright$  arrow button to enter the Screen Setup sub-menu. The Screen Setup feature allows you to change what information is displayed in the instrument cluster as well as the location that information is displayed.

## UNIVERSAL GARAGE DOOR OPENER (HOMELINK)

HomeLink replaces up to three hand-held transmitters that operate devices such as garage door openers, motorized gates, lighting or home security systems. The HomeLink unit is powered by your vehicle's 12 Volt battery.

The HomeLink buttons that are located in the overhead console or sunvisor designate the three different HomeLink channels.

The HomeLink indicator is located above the center button.

### Before You Begin Programming HomeLink

Ensure that your vehicle is parked outside of the garage before you begin programming.

For efficient programming and accurate transmission of the radio-frequency signal, it is recommended that a new battery be placed in the hand-held transmitter of the device that is being programmed to the HomeLink system.

To erase the channels, place the ignition switch into the ON/RUN position, then push and hold the two outside HomeLink buttons (I and III) for up to 20 seconds or until the red indicator flashes.

#### NOTE:

Erasing all channels should only be performed when programming HomeLink for the first time. Do not erase channels when programming additional buttons.

If you have any problems, or require assistance, please call toll-free 1-800-355-3515 or, on the Internet at [HomeLink.com](http://HomeLink.com) for information or assistance.



Universal Garage Door Opener (HomeLink) Buttons

## Programming A Rolling Code

### NOTE:

For programming Garage Door Openers that were manufactured after 1995. These Garage Door Openers can be identified by the “LEARN” or “TRAIN” button located where the hanging antenna is attached to the Garage Door Opener. It is NOT the button that is normally used to open and close the door. The name and color of the button may vary by manufacturer.

1. Place the ignition switch into the ON/RUN position.
2. Place the hand-held transmitter 1 to 3 inch (3 to 8 cm) away from the HomeLink button you wish to program while keeping the HomeLink indicator light in view.
3. Simultaneously press and hold both the Homelink button you want to program and the hand-held transmitter button.
4. Continue to hold the buttons until the EVIC/DID display changes from “CHANNEL # TRAINING” to “CHANNEL # TRAINED”, then release both buttons.

### NOTE:

If the EVIC/DID displays “DID NOT TRAIN” repeat from Step 2.

5. At the garage door opener motor (in the garage), locate the “LEARN” or “TRAINING” button. This can usually be found where the hanging antenna wire is attached to the garage door opener motor. Firmly press and release the “LEARN” or “TRAINING” button.

### NOTE:

You have 30 seconds in which to initiate the next step after the LEARN button has been pressed.

6. Return to the vehicle and press the programmed HomeLink button twice (holding the button for two seconds each time). The EVIC/DID will display “CHANNEL # TRANSMIT”. If the garage door opener/device activates, programming is complete.

### NOTE:

If the device does not activate, press the button a third time (for two seconds) to complete the training.

7. To program the remaining two HomeLink buttons, repeat each step for each remaining button. DO NOT erase the channels.

## Programming A Non-Rolling Code

### NOTE:

For programming Garage Door Openers manufactured before 1995.

1. Turn the ignition switch to the ON/RUN position.
2. Place the hand-held transmitter 1 to 3 inch (3 to 8 cm) away from the HomeLink button you wish to program while keeping the HomeLink indicator light in view.
3. Simultaneously press and hold both the HomeLink button you want to program and the hand-held transmitter button.
4. Continue to hold both buttons until the EVIC/DID display changes from "CHANNEL # TRAINING" to "CHANNEL # TRAINED", then release both buttons.
5. Press and hold the programmed HomeLink button and observe the indicator light.

### NOTE:

If the EVIC/DID displays "DID NOT TRAIN" repeat from Step 2.

- To program the two remaining HomeLink buttons, repeat each step for each remaining button. DO NOT erase the channels.

## Using HomeLink

To operate, push and release the programmed HomeLink button. Activation will now occur for the programmed device (i.e., garage door opener, gate operator, security system, entry door lock, home/office lighting, etc.). The hand-held transmitter of the device may also be used at any time.

### WARNING!

- Your motorized door or gate will open and close while you are programming the universal transceiver. Do not program the transceiver if people or pets are in the path of the door or gate.
- Do not run your vehicle in a closed garage or confined area while programming the transceiver. Exhaust gas from your vehicle contains Carbon Monoxide (CO) which is odorless and colorless. Carbon Monoxide is poisonous when inhaled and can cause you and others to be severely injured or killed.

## POWER INVERTER

A 115 Volt, 150 Watt power inverter outlet is located on the lower instrument panel next to the climate control knob. This outlet can power cellular phones, electronics and other low power devices requiring power up to 150 Watts.

To turn on the power outlet, simply plug in the device. The outlet automatically turns off when the device is unplugged.

### NOTE:

The power inverter is designed with built-in overload protection. If the power rating of 150 Watts is exceeded, the power inverter will automatically shut down. Once the electrical device has been removed from the outlet, the inverter should automatically reset.



Power Inverter

### WARNING!

To Avoid Serious Injury or Death DO NOT:

- insert any objects into the receptacles
- touch with wet hands

Close the lid when not in use. If this outlet is mishandled, it may cause an electric shock and failure.

## POWER OUTLETS

The auxiliary 12 Volt (13 Amp) power outlets can provide power for in-cab accessories designed for use with the standard “cigar lighter” plug. The 12 Volt power outlets have a cap attached to the outlet indicating “12V DC”, together with either a key symbol or a battery symbol.

The auxiliary power outlets can be found in the following locations:

- Lower left and lower right in the center of the instrument panel – if equipped with a column or a eight-speed electronic shifter.
- Inside the top storage tray.



**Power Outlet — Center Console**

- Rear of the center console storage compartment.



**Power Outlet — Rear Console**

# ELECTRONICS

- Inside the upper lid of the center storage compartment.

## NOTE:

- Do not exceed the maximum power of 160 Watts (13 Amps) at 12 Volts. If the 160 Watt (13 Amp) power rating is exceeded, the fuse protecting the system will need to be replaced.
- Power outlets are designed for accessory plugs only. Do not insert any other object in the power outlet as this will damage the outlet and blow the fuse. Improper use of the power outlet can cause damage not covered by your new vehicle warranty.
- The rear center console power outlet can be switched to “battery” powered all the time by switching the power outlet rear center console fuse in the fuse panel.



**Power Outlet (USB Charge Only Port) — Storage Compartment**

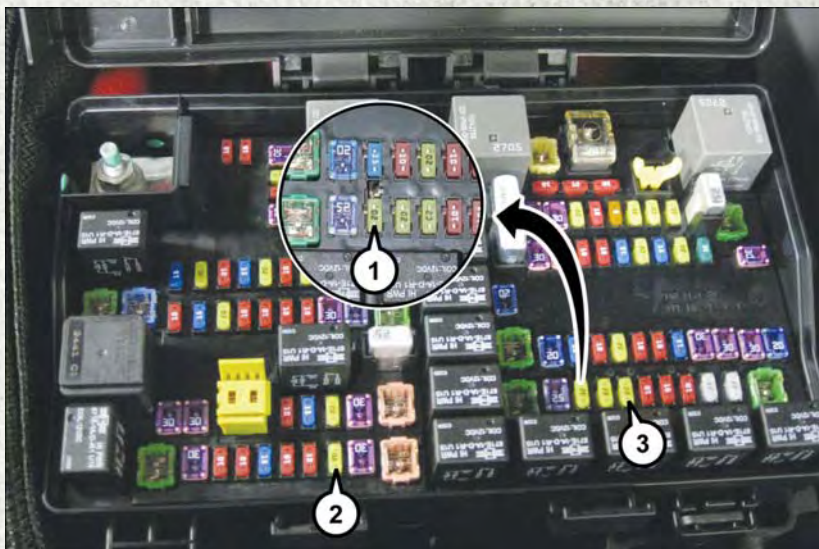

**Power Outlet Fuse Locations**

- 1 — F90 – F91 Fuse 20A Yellow Power Outlet Rear Center Console
- 2 — F104 Fuse 20A Yellow Power Outlet Center Console
- 3 — F93 Fuse 20A Yellow Cigar Lighter Instrument Panel

## AUXILIARY SWITCHES — IF EQUIPPED

There can be up to five auxiliary switches located in the lower switch bank of the instrument panel which can be used to power various electronic devices and PTO (Power Take Off) – If Equipped. If Power Take Off is equipped, it will take the place of the fifth Auxiliary switch. Connections to the switches are found under the hood in the connectors attached to the auxiliary Power Distribution Center.

You have the ability to configure the functionality of the auxiliary switches via the Electronic Vehicle Information Center (EVIC) or Driver Information Display (DID). All switches can now be configured for setting the switch type operation to latching or momentary, power source of either battery or ignition, and ability to hold last state across key cycles.

### **NOTE:**

Holding last state conditions are met when switch type is set to latching and power source is set to ignition.

For further information on using the auxiliary switches, please refer to the Ram Body Builders Guide by accessing [www.rambodybuilder.com](http://www.rambodybuilder.com) and choosing the appropriate links.

# OFF-ROAD CAPABILITIES

## ELECTRONICALLY SHIFTED FOUR WHEEL DRIVE OPERATION

The four position electronically shifted transfer case provides four mode positions:

- Two-wheel drive high range (2WD)
- Four-wheel drive high range (4WD LOCK)
- Four-wheel drive low range (4WD LOW)
- NEUTRAL (N)

This transfer case is intended to be driven in the 2WD position for normal street and highway conditions, such as dry, hard-surfaced roads.

When additional traction is required, the 4WD LOCK and 4WD LOW positions can be used to lock the front and rear drive-shafts together.

When operating your vehicle in 4WD LOW, do not exceed 25 mph (40 km/h).

### Shifting Procedure

Shifting between 2WD and 4WD LOCK can be made with the vehicle stopped or in motion at speeds up to 55 mph (88 km/h).

Shifting between 2WD or 4WD LOCK into 4WD LOW must be made with the transmission in NEUTRAL and the vehicle stopped or rolling at 2 to 3 mph (3 to 5 km/h).

### NOTE:

It is preferred to have the engine running and the vehicle moving at 2 to 3 mph (3 to 5 km/h).



**Four-Position/Part Time Transfer Case**

- 1 — Neutral Button
- 2 — Rotary 2WD/4WD Control Knob

## WARNING!

You or others could be injured if you leave the vehicle unattended with the transfer case in the NEUTRAL position without first fully engaging the parking brake. The transfer case NEUTRAL position disengages both the front and rear driveshafts from the powertrain and will allow the vehicle to move regardless of the transmission position. The parking brake should always be applied when the driver is not in the vehicle.



# OFF-ROAD CAPABILITIES

These five position electronically shifted transfer cases provide five mode positions:

- Two-wheel drive high range (2WD)
- Four-wheel drive automatic range (4WD AUTO)
- Four-wheel drive lock range (4WD LOCK)
- Four-wheel drive low range (4WD LOW)
- NEUTRAL (N)

These electronically shifted transfer cases are designed to be driven in the two-wheel drive position (2WD) or four-wheel drive position (4WD AUTO) for normal street and highway conditions on dry, hard-surfaced roads.

Driving the vehicle in 2WD will have greater fuel economy benefits as the front axle is not engaged in 2WD.



**Five-Position/On-Demand Transfer Case**

- 1 — Neutral Button
- 2 — Rotary 2WD/4WD Control Knob



**Five-Position/On-Demand Transfer Case — Eight Speed Transmission Only**

# OFF-ROAD CAPABILITIES

## Shifting Procedure

Shifting between 2WD and 4WD AUTO or 4WD LOCK can be made with the vehicle stopped or in motion at speeds up to 55 mph (88 km/h).

Shifting between 2WD, 4WD AUTO and 4WD LOCK into 4WD LOW must be made with the transmission in NEUTRAL and the vehicle stopped or rolling at 2 to 3 mph (3 to 5 km/h).

### NOTE:

It is preferred to have the engine running and the vehicle moving at 2 to 3 mph (3 to 5 km/h).

## WARNING!

You or others could be injured if you leave the vehicle unattended with the transfer case in the NEUTRAL position without first fully engaging the parking brake. The transfer case NEUTRAL position disengages both the front and rear driveshafts from the powertrain and will allow the vehicle to move regardless of the transmission position. The parking brake should always be applied when the driver is not in the vehicle.

## TONNEAU COVER

The Tonneau Cover can be removed and reinstalled by using the locking clamps located underneath the Tonneau Cover.

**NOTE:**

Be sure that the Tonneau Cover is secured before driving.

## EASY-OFF TAILGATE

To simplify mounting of a camper unit with an overhang, the tailgate can be removed.

**NOTE:**

If your vehicle is equipped with a rear camera or RKE the electrical connector must be disconnected prior to removing the tailgate.

### Removing The Tailgate

1. Disconnect the wiring harness for the rear camera or RKE (if equipped).
2. Unlatch the tailgate and remove the support cables by releasing the lock tang from the pivot.
3. Raise the right side of the tailgate until the right side pivot clears the hanger bracket.
4. Slide the entire tailgate to the right to free the left side pivot.
5. Remove the tailgate from the vehicle.

**NOTE:**

Do not carry the tailgate loose in the truck pickup box.

### Locking Tailgate

The lock is located next to the tailgate handle. The tailgate can be locked using the vehicle key.

#### **WARNING!**

To avoid inhaling carbon monoxide, which is deadly, the exhaust system on vehicles equipped with "Cap or Slide-In Campers" should extend beyond the overhanging camper compartment and be free of leaks.

## PICKUP BOX

The pickup box has many features designed for utility and convenience.

### NOTE:

If you are installing a Toolbox, Ladder Rack or Headache Rack at the front of the Pickup Box, you must use Mopar Box Reinforcement Brackets that are available from your authorized dealer.

You can carry wide building materials (sheets of plywood, etc.) by building a raised load floor. Place lumber across the box in the indentations provided above the wheel housings and in the bulkhead dividers to form the floor.

### WARNING!

- The pickup box is intended for load carrying purposes only, not for passengers, who should sit in seats and use seat belts.
- Care should always be exercised when operating a vehicle with unrestrained cargo. Vehicle speeds may need to be reduced. Severe turns or rough roads may cause shifting or bouncing of the cargo that may result in vehicle damage. If wide building materials are to be frequently carried, the installation of a support is recommended. This will restrain the cargo and transfer the load to the pickup box floor.
- If you wish to carry more than 600 lbs (272 kg) of material suspended above the wheelhouse, supports must be installed to transfer the weight of the load to the pickup box floor or vehicle damage may result. The use of proper supports will permit loading up to the rated payload.
- Unrestrained cargo may be thrown forward in an accident causing serious or fatal injury.

There are stampings in the sheet metal on the inner side bulkheads of the box in front of and behind both wheel housings. Place wooden boards across the box from side to side to create separate load compartments in the pickup box.

There are four tie-down cleats bolted to the lower sides of the pickup box that can sustain loads up to 1000 lbs (450 kg) total.

## Cargo Camera — If Equipped

Your vehicle may be equipped with the Cargo Camera that allows you to see an image of the inside of the pickup box. The image will be displayed in the Uconnect screen.

A display timer is initiated when the cargo camera image is displayed. The image will continue to be displayed until the display timer exceeds 10 seconds and the vehicle speed is above 8 mph (13 km/h) or the touchscreen button "X" to disable display of the Cargo Camera image is pressed.

**NOTE:**

If the vehicle speed remains below 8 mph (13 km/h), the cargo camera image will be displayed continuously until the touchscreen button "X" to disable display of the Cargo Camera image is pressed.

The Cargo Camera is located in the bottom center area of the center high-mounted stoplamp (CHMSL).

A touchscreen button  to indicate the current active Camera image being displayed is made available whenever the Cargo camera image is displayed.

Also, a touchscreen button  to switch the display to Rear View camera image is made available whenever the Cargo camera image is displayed.

A touchscreen button "X" to disable display of the camera image is made available when the vehicle is not in REVERSE gear.

**NOTE:**

If snow, ice, mud, or any foreign substance builds up on the camera lens, clean the lens, rinse with water, and dry with a soft cloth. Do not cover the lens.

**Turning Cargo Camera On Or Off — With Uconnect 8.4A/8.4AN**

1. Press the "Controls" button located on the bottom of the Uconnect display.
2. Press the "Cargo Camera" button  to turn the Cargo Camera system ON.

**NOTE:**

Once initiated by the "Cargo Camera" button, the Cargo Camera image may be deactivated by pressing the "X" soft button. On deactivation, the previous selected screen will appear.



**Cargo Camera Display**

## RAMBOX



**RamBox Features**

- 1 — Bed Extender
  - 2 — Bed Rail Tie-Down System Adjustable Cleats
  - 3 — Storage Bin
  - 4 — Push The Button To Open
- 

The RamBox system is an integrated pickup box storage and cargo management system consisting of three features:

- Integrated box side storage bins
- Cargo extender/divider
- Bed rail tie-down system

## RamBox Integrated Box Side Storage Bins

The cargo storage bins provide watertight, lockable, illuminated storage for up to 150 lbs (68 kg) of evenly distributed cargo.

- To open a storage bin, push and release the button located on the lid.
- The interior of the RamBox will automatically illuminate when the lid is opened. Pushing the switch once will turn off the bin lights, pushing the switch again will turn the lights back on.
- Storage bins feature two removable drain plugs (to allow water to drain from bins). To remove plug, pull up on the edge. To install, push plug downward into drain hole.

The RamBox storage bins can be locked and unlocked using the vehicle key or the remote keyless entry transmitter.

### NOTE:

Provisions are provided in the bins for cargo dividers and shelf supports. These accessories (in addition to other RamBox accessories) are available from MOPAR.

## RamBox Storage Bin Cover Emergency Release Lever

As a security measure, a Storage Bin Cover Emergency Release is built into the storage bin cover latching mechanism.

### NOTE:

In the event of an individual being locked inside the storage bin, the storage bin cover can be opened from inside of the bin by pulling on the glow-in-the-dark lever attached to the storage bin cover latching mechanism.

## Bed Extender

The bed extender has three functional positions:

- Storage Position
- Divider Position
- Extender Position

### Storage Position

The storage position for the bed extender is at the front of the truck bed.

To install the bed extender into the storage position, perform the following:

1. Make sure the center handle is unlocked using the vehicle key and rotate the center handle vertically to release the extender side gates.
2. With the side gates open, position the extender fully forward in the bed against the front panel.
3. Rotate the side gates closed allowing the outboard ends to be positioned in front of the cargo tie-down loops.

4. Rotate the center handle horizontally to secure the side gates in the closed position.
5. Lock the center handle using the vehicle key to secure the panel into place and assist against theft.

## **Divider Position**

There are 11 divider slots along the bed inner panels which allow for various positions to assist in managing your cargo.

To install the bed extender into a divider position perform the following:

1. Make sure the center handle is unlocked using the vehicle key and rotate the center handle vertically to release the extender side gates.
2. With the side gates open, position the extender so the outboard ends align with the intended slots in the sides of the bed.
3. Rotate the side gates closed so that the outboard ends are secured into the intended slots of the bed.
4. Rotate the center handle horizontally to secure the side gates in the closed position.
5. Lock the center handle to secure the panel into place and assist against theft.

## **Extender Position**

The bed extender will add an additional 15 in (38 cm) in the back of the truck when additional cargo room is needed.

To install the bed extender into the extender position, perform the following:

1. Lower the tailgate.
2. Make sure the center handle is unlocked and rotate the center handle vertically in order to release the extender side gates.
3. Fit the end of the side gate ends onto the pin and handle.
4. Rotate the handles to the horizontal position to secure into place.

## **Bed Rail Tie-Down System**

There are two adjustable cleats on each side of the bed that can be used to assist in securing cargo.

Each cleat must be located and tightened down in one of the detents, along either rail, in order to keep cargo properly secure.

- To move the cleat to any position on the rail, turn the nut counterclockwise, approximately three turns. Then, pull out on the cleat and slide it to the detent nearest the desired location. Make sure the cleat is seated in the detent and tighten the nut.



- To remove the cleats from the utility rail, remove the end cap by pushing up on the locking tab, located on the bottom of the end cap. Slide the cleat off the end of the rail.

**CAUTION!**

Failure to follow the following items could cause damage to the vehicle:

- Assure that all cargo inside the storage bins is properly secured.
- Do not exceed cargo weight rating of 150 lb (68 kg) per bin.
- Leaving the lid open for extended periods of time could cause the vehicle battery to discharge. If the lid is required to stay open for extended periods of time, it is recommended that the bin lights be turned off manually using the on/off switch.
- Ensure cargo bin lids are closed and latched before moving or driving vehicle.
- Loads applied to the top of the bin lid should be minimized to prevent damage to the lid and latching/hinging mechanisms.
- Damage to the RamBox bin may occur due to heavy/sharp objects placed in bin that shift due to vehicle motion. In order to minimize potential for damage, secure all cargo to prevent movement and protect inside surfaces of bin from heavy/sharp objects with appropriate padding.
- The maximum load per cleat should not exceed 250 lbs (113 kg) and the angle of the load on each cleat should not exceed 60 degrees above horizontal, or damage to the cleat or cleat rail may occur.
- Do not use a storage bin latch as a tie down.
- To reduce the risk of potential injury or property damage:
  - Cargo must be secured.
  - Do not exceed cargo load rating of your vehicle.
  - Secure all loads to truck utilizing cargo tie-downs.
  - Extender should not be used as cargo tie-down.
  - When vehicle is in motion do not exceed 150 lbs (68 kg) load on the tailgate.
  - The bed extender is not intended for off road use.
  - When not in use, the extender/divider should be in stowed or divider position with the tailgate closed.
  - When in use, all handles are to be in the locked position.

**WARNING!**

- Always close the storage bin covers when your vehicle is unattended or in motion.
- Do not allow children to have access to the storage bins. Once in the storage bin, young children may not be able to escape. If trapped in the storage bin, children can die from suffocation or heat stroke.
- In a collision, serious injury could result if the storage bin covers are not properly latched.

## TOWING & PAYLOAD

### NOTE:

For additional trailer towing information (maximum trailer weight ratings) refer to the following website addresses:

- [ramtrucks.com/en/towing\\_guide/](http://ramtrucks.com/en/towing_guide/)
- [ramtruck.ca](http://ramtruck.ca) (Canada)
- [rambodybuilder.com](http://rambodybuilder.com)

## TOW/HAUL MODE

When driving in hilly areas, towing a trailer, carrying a heavy load, etc., and frequent transmission shifting occurs, push the TOW/HAUL switch to select TOW/HAUL mode. This will improve performance and reduce the potential for transmission overheating or failure due to excessive shifting. When operating in TOW/HAUL mode, transmission upshifts are delayed, and the transmission will automatically downshift (for engine braking) during steady braking maneuvers.

The “TOW/HAUL Indicator Light” will illuminate in the instrument cluster to indicate that TOW/HAUL mode has been activated. Pushing the switch a second time restores normal operation. If the TOW/HAUL mode is desired, the switch must be pushed each time the engine is started.



**TOW/HAUL Switch**

## INTEGRATED TRAILER BRAKE MODULE

The Integrated Trailer Brake Controller allows you to automatically or manually activate the Electric Trailer Brakes and Electric Over Hydraulic Trailer Brakes for a better braking performance when towing a trailer.

### NOTE:

The Integrated Trailer Brake Controller is located in the center stack below the climate controls.

This module will have four different options depending on the type of trailer you want to tow and can be selected through the 3.5" Electronic Vehicle Information Center (EVIC) or touchscreen radio.

- Light Electric
- Heavy Electric
- Light EOH (Electric Over Hydraulic)
- Heavy EOH (Electric Over Hydraulic)

### Setting With The Uconnect Touchscreen Radio

To make the proper selection in the Uconnect touchscreen radio, push the More button on the faceplate (Uconnect 5.0) or press the "Apps" button on the touchscreen (Uconnect 8.4), then press the "Settings" button on the touchscreen to display the menu setting screen and press "Trailer Brake". For additional information, refer to your Owner's Manual on the DVD.

### Setting With 3.5" EVIC

1. Push the RIGHT arrow on the steering wheel to enter "VEHICLE SETTINGS".
2. Push the UP or DOWN buttons until Trailer Brake Type appears on the screen.
3. Push the RIGHT arrow and then push the UP or DOWN buttons until the proper Trailer Brake Type appears on the screen. For additional information, refer to your Owner's Manual on the DVD.

## GAIN Adjustment Buttons (+/-)

Pushing the +/- buttons, located on the left side of the module, will increase/decrease the brake control power output to the trailer brakes in 0.5 increments. The GAIN setting can be increased to a maximum of 10 or decreased to a minimum of 0 (no trailer braking).

Refer to your Owner's Manual on the DVD for further details.



**Adjustment Buttons**

- 1 — Decrease (-)
- 2 — Increase (+)

### **WARNING!**

Connecting a trailer that is not compatible with the ITBM system may result in reduced or complete loss of trailer braking. There may be an increase in stopping distance or trailer instability which could result in personal injury.

## RECREATIONAL TOWING (BEHIND MOTORHOME, ETC.)

### Towing This Vehicle Behind Another Vehicle

Towing Condition	Wheels OFF The Ground	Two-Wheel Drive Models	Four-Wheel Drive Models
Flat Tow	NONE	<b>NOT ALLOWED</b>	<b>See Instructions</b> <ul style="list-style-type: none"> <li>• Automatic transmission in PARK</li> <li>• Manual transmission in gear (NOT in NEUTRAL)</li> <li>• Transfer case in NEUTRAL (N)</li> <li>• Tow in forward direction</li> </ul>
Dolly Tow	Front	<b>NOT ALLOWED</b>	<b>NOT ALLOWED</b>
	Rear	OK	<b>NOT ALLOWED</b>
On Trailer	ALL	OK	OK

#### NOTE:

- When recreational towing your vehicle, always follow applicable state and provincial laws. Contact state and provincial Highway Safety offices for additional details.
- Vehicles equipped with air suspension must be placed in Transport mode before tying them down (from the body) on a trailer or flatbed truck. Refer to “Air Suspension – If Equipped” for more information. If the vehicle cannot be placed in Transport mode (for example, engine will not run), tie-downs must be fastened to the axles (not to the body). Failure to follow these instructions may cause fault codes to be set and/or cause loss of proper tie-down tension.

## Recreational Towing — Two-Wheel Drive Models

**DO NOT flat tow this vehicle. Damage to the drivetrain will result.**

Recreational towing (for two-wheel drive models) is allowed **ONLY** if the rear wheels are **OFF** the ground. This may be accomplished using a tow dolly or vehicle trailer. If using a tow dolly, follow this procedure:

**NOTE:**

If vehicle is equipped with air suspension, ensure the vehicle is set to Normal Ride Height.

1. Properly secure the dolly to the tow vehicle, following the dolly manufacturer's instructions.
2. Drive the rear wheels onto the tow dolly.
3. Firmly apply the parking brake. Place automatic transmission in PARK, manual transmission in gear (not in NEUTRAL).
4. Properly secure the rear wheels to the dolly, following the dolly manufacturer's instructions.
5. Turn the ignition switch to the OFF position and remove the Key Fob.
6. Install a suitable clamping device, designed for towing, to secure the front wheels in the straight position.

### **CAUTION!**

- Towing with the rear wheels on the ground will cause severe transmission damage. Damage from improper towing is not covered under the New Vehicle Limited Warranty.
- Do not disconnect the driveshaft because fluid may leak from the transmission, causing damage to internal parts.

## Recreational Towing — Four-Wheel Drive Models

### NOTE:

Both the manual shift and electronic shift transfer cases must be shifted into NEUTRAL (N) for recreational towing. Automatic transmissions must be shifted into PARK for recreational towing. Manual transmissions must be placed in gear (NOT in NEUTRAL) for recreational towing. Refer to the following for the proper transfer case NEUTRAL (N) shifting procedure for your vehicle.

### CAUTION!

- Front or rear wheel lifts should not be used while recreational towing. Towing with only one set of wheels on the ground (front or rear) will cause severe damage to the transmission and or transfer case. Tow with all four wheels either **ON** the ground, or **OFF** the ground (using a vehicle trailer). Damage from improper towing is not covered under the New Vehicle Limited Warranty.
- Do not disconnect the driveshaft because fluid may leak from the transmission, causing damage to internal parts.
- Front or rear wheel lifts should not be used. Internal damage to the transmission or transfer case will occur if a front or rear wheel lift is used when recreational towing.
- Tow only in the forward direction. Towing this vehicle backwards can cause severe damage to the transfer case.
- Before recreational towing, the transfer case must be in NEUTRAL. To be certain the transfer case is fully in NEUTRAL, perform the procedure outlined under “Shifting Into NEUTRAL”. Internal transmission damage will result, if the transfer case is not in NEUTRAL during towing.
- Manual transmissions must be placed in gear (not in Neutral) for recreational towing.
- Before recreational towing, perform the procedure outlined under “Shifting Into NEUTRAL” to be certain that the transfer case is fully in NEUTRAL. Otherwise, internal damage will result.
- Towing this vehicle in violation of the above requirements can cause severe transmission and/or transfer case damage. Damage from improper towing is not covered under the New Vehicle Limited Warranty.
- Do not disconnect the rear driveshaft because fluid will leak from the transfer case, causing damage to internal parts.
- Do not use a bumper-mounted clamp-on tow bar on your vehicle. The bumper face bar will be damaged.

## Shifting Into NEUTRAL (N)

Use the following procedure to prepare your vehicle for recreational towing.

### WARNING!

You or others could be injured or killed if you leave the vehicle unattended with the transfer case in the NEUTRAL (N) position without first fully engaging the parking brake. The transfer case NEUTRAL (N) position disengages both the front and rear drive shaft from the powertrain, and will allow the vehicle to roll, even if the automatic transmission is in PARK (or manual transmission is in gear). The parking brake should always be applied when the driver is not in the vehicle.

### CAUTION!

It is necessary to follow these steps to be certain that the transfer case is fully in NEUTRAL (N) before recreational towing to prevent damage to internal parts.

1. Bring the vehicle to a complete stop, with the engine running. Firmly apply the parking brake.
2. Shift the transmission to NEUTRAL.

### NOTE:

If vehicle is equipped with air suspension, ensure the vehicle is set to Normal Ride Height.

3. Press and hold the brake pedal.
4. Depress the clutch pedal on a manual transmission.
5. With manual shift transfer case, shift the transfer case lever into NEUTRAL (N).
  - With electronic shift transfer case, push and hold the transfer case NEUTRAL (N) button. Some models have a small, recessed "N" button (at the center of the transfer case switches) that must be pushed using a ballpoint pen or similar object. Other models have a rectangular NEUTRAL switch, below the rotary transfer case control knob. The NEUTRAL (N) indicator light will blink while the shift is in progress. The light will stop blinking (stay on solid) when the shift to NEUTRAL (N) is complete. After the shift is completed and the NEUTRAL (N) light stays on, release the NEUTRAL (N) button.
6. Release the parking brake.
7. Shift the transmission into REVERSE.
8. Release the brake pedal (and clutch pedal on manual transmissions) for five seconds and ensure that there is no vehicle movement.
9. Repeat steps 7 and 8 with automatic transmission in DRIVE or manual transmission in first gear.



10. Shift the transmission to NEUTRAL. Firmly apply the parking brake. Turn OFF the engine. For vehicles with Keyless Enter-N-Go, push and hold the ENGINE START/STOP button until the engine shuts off.
11. Shift the transmission into PARK or place manual transmission in gear (NOT in Neutral). On 8-speed transmissions the shifter will automatically select PARK when the engine is turned off.
12. Turn the ignition switch to the OFF position, then cycle the Key or the Keyless Enter-N-Go button to the RUN position and back to the OFF position. Remove the Key Fob from the ignition switch.
13. Attach the vehicle to the tow vehicle using a suitable tow bar.
14. Release the parking brake.

**NOTE:**

With electronic shift transfer case:

- Steps 2 through 4 are requirements that must be met before pushing the NEUTRAL (N) button, and must continue to be met until the shift has been completed. If any of these requirements are not met before pushing the NEUTRAL (N) button or are no longer met during the shift, the NEUTRAL (N) indicator light will flash continuously until all requirements are met or until the NEUTRAL (N) button is released.
- The ignition switch must be in the ON/RUN position for a shift to take place and for the position indicator lights to be operable. If the ignition switch is not in the ON/RUN position, the shift will not take place and no position indicator lights will be on or flashing.
- A flashing NEUTRAL (N) position indicator light indicates that shift requirements have not been met.
- If the vehicle is equipped with air suspension, the engine should be started and left running for a minimum of 60 seconds (with all the doors closed) at least once every 24 hours. This process allows the air suspension to adjust the vehicle's ride height to compensate for temperature effects.

**Shifting Out Of NEUTRAL (N)**

Use the following procedure to prepare your vehicle for normal usage:

1. Bring the vehicle to a complete stop, leaving it connected to the tow vehicle.
2. Firmly apply the parking brake.
3. Press and hold the brake pedal.
4. Start the engine. Shift the transmission into NEUTRAL. Depress the clutch pedal on a manual transmission.
  - With manual shift transfer case, shift the transfer case lever to the desired position.

- With electronic shift transfer case with rotary selector switch, push and hold the transfer case NEUTRAL (N) button until the NEUTRAL (N) indicator light turns off. After the NEUTRAL (N) indicator light turns off, release the NEUTRAL (N) button. After the NEUTRAL (N) button has been released, the transfer case will shift to the position indicated by the selector switch.
- With electronic shift transfer case with push-button selector switch, push and hold the switch for the desired transfer case position, until the NEUTRAL (N) indicator light turns off and the desired position indicator light turns on.

**NOTE:**

When shifting out of transfer case NEUTRAL (N), turning the engine OFF is not required, but may be helpful to avoid gear clash. With the 8-speed automatic transmission, the engine must remain running, since turning the engine OFF will shift the transmission to PARK (and the transmission must be in NEUTRAL for the transfer case to shift out of NEUTRAL).

5. Turn the engine OFF. Shift automatic transmission into PARK. On 8-speed transmissions the shifter will automatically select PARK when the engine is turned off.
6. Release the brake pedal (and clutch pedal on a manual transmission).
7. Disconnect vehicle from the tow vehicle.
8. Start the engine.
9. Press and hold the brake pedal.
10. Release the parking brake.
11. Shift the transmission into gear, release the brake pedal (and clutch pedal on manual transmissions), and check that the vehicle operates normally.

**NOTE:**

With electronic shift transfer case:

- Steps 3 and 4 are requirements that must be met before pushing the button to shift out of NEUTRAL (N), and must continue to be met until the shift has been completed. If any of these requirements are not met before pushing the button or are no longer met during the shift, the NEUTRAL (N) indicator light will flash continuously until all requirements are met or until the button is released.
- The ignition switch must be in the ON/RUN position for a shift to take place and for the position indicator lights to be operable. If the ignition switch is not in the ON/RUN position, the shift will not take place and no position indicator lights will be on or flashing.
- A flashing NEUTRAL (N) position indicator light indicates that shift requirements have not been met.

## DIESEL ENGINE BREAK-IN RECOMMENDATIONS

The 3.0 turbocharged diesel engine does not require a break-in period due to its construction. Normal operation is allowed, providing the following recommendations are followed:

- Warm up the engine before placing it under load.
- Do not operate the engine at idle for prolonged periods.
- Use the appropriate transmission gear to prevent engine lugging.
- Observe vehicle oil pressure and temperature indicators.
- Check the coolant and oil levels frequently.
- Vary throttle position at highway speeds when carrying or towing significant weight.

### NOTE:

Light duty operation such as light trailer towing or no load operation will extend the time before the engine is at full efficiency. Reduced fuel economy and power may be seen at this time.

The engine oil installed in the engine at the factory is a high-quality energy conserving type lubricant. Oil changes should be consistent with anticipated climate conditions under which vehicle operations will occur. The recommended viscosity and quality grades are shown under “FLUIDS AND CAPACITIES”, under “MAINTAINING YOUR VEHICLE” in this User Guide. NON-DETERGENT OR STRAIGHT MINERAL OILS MUST NEVER BE USED.

## DIESEL ENGINE STARTING PROCEDURES

### Normal Starting Procedure

1. Apply the parking brake.
2. Ensure the shift lever is in the PARK position.
3. Press and hold the brake pedal while pushing the ENGINE START/STOP button once and the system will engage the starter to crank the engine.

### NOTE:

- A delay of the start of up to five seconds is possible under very cold conditions. The “Wait to Start” telltale will be illuminated during the pre-heat process. When the engine Wait To Start light goes off the engine will automatically crank.
  - If you wish to stop the cranking of the engine prior to the engine starting, push the button again.
4. Check that the oil pressure warning light has turned off.
  5. Release the parking brake.

## CAUTION!

If the “Water in Fuel Indicator Light” remains on, DO NOT START the engine before you drain the water from the fuel filters to avoid engine damage. Refer to “Maintenance Procedures/Draining Fuel/Water Separator Filter” in “Maintaining Your Vehicle” in your Diesel Supplement on the DVD for further information.

### Extreme Cold Weather

The engine block heater is a resistance heater installed in the water jacket of the engine. It requires a 110–115 Volt AC electrical outlet with a grounded, three-wire extension cord.

Its use is recommended for environments that routinely fall below -10°F. It should be used when the vehicle has not been running overnight or longer periods and should be plugged in two hours prior to start. Its use is required for cold starts with temperatures under -20°F.

A 12 Volt heater built into the fuel filter housing aids in preventing fuel gelling. It is controlled by a built-in thermostat.

A Diesel Pre-Heat system both improves engine starting and reduces the amount of white smoke generated by a warming engine.

#### NOTE:

The engine block heater cord is a factory installed option. If your vehicle is not equipped, heater cords are available from your authorized MOPAR dealer.

### Winter Front Usage

A winter front or cold weather cover is to be used in ambient temperatures below 32°F (0°C), especially during extended idle conditions to reduce condensation build-up within engine crankcase. If a winter front or cold weather cover is to be used, a percentage of the total grille opening area must be left uncovered to provide sufficient air flow to the charge air cooler and automatic transmission oil cooler. The percentage of opening must be increased with the increasing ambient air temperature and/or engine load. If the cooling fan can be heard cycling frequently, increase the size of the opening in the winter front. A suitable cold weather cover is available from your MOPAR dealer.

### Water In Fuel Message

If a Water In Fuel message or  indicator appears in the cluster and a chime sounds five times, the fuel/water separator will need to be drained immediately to prevent engine damage.

Refer to “Draining Fuel Water Separator” in this guide for draining instructions or see your dealer.

## DIESEL FUEL FILTER/WATER SEPARATOR

### Draining Fuel/Water Separator

If the “Water in Fuel” indicator light  is illuminated and an audible chime is heard five times, you should stop the engine and drain the water from the separator.

The drain plug is located on the bottom of the Fuel Filter and Water Separator assembly which is located above the rear axle next to the fuel tank.

Loosen the drain plug (located on the bottom filter assembly) then turn the ignition switch to the ON/RUN position to allow any accumulated water to drain.

When clean fuel is visible, close the drain and switch the ignition to the OFF position.

Refer to the Diesel Supplement on the DVD for further details.

### Fuel Filter Replacement

1. Ensure engine is turned off.
2. Place drain pan under the fuel filter assembly.
3. Open the water drain valve, and let any accumulated water drain.
4. Close the water drain valve.
5. Remove bottom cover using a strap wrench. Rotate counterclockwise for removal. Remove the used o-ring and discard it.
6. Remove the used filter cartridge from the housing and dispose of according to your local regulations.
7. Wipe the sealing surfaces of the lid and housing clean.
8. Install new o-ring back into ring groove on the filter housing and lubricate with clean engine oil.

#### NOTE:

The WIF (Water In Fuel) sensor is re-usable. Service kit comes with new o-ring for filter canister and WIF (Water In Fuel) sensor.

#### CAUTION!

- Diesel fuel will damage blacktop paving surfaces. Drain the filter into an appropriate container.
- Do not prefill the fuel filter when installing a new fuel filter. There is a possibility debris could be introduced into the fuel filter during this action. It is best to install the filter dry and allow the in-tank lift pump to prime the fuel system.
- If the “Water In Fuel Indicator Light” remains on, DO NOT START the engine before you drain water from the fuel filter to avoid engine damage.

# 1500 3.0L DIESEL

## EXHAUST REGENERATION

This engine meets all required EPA diesel engine emissions standards. To achieve these emissions standards, your vehicle is equipped with a state-of-the-art engine and exhaust system. These systems are seamlessly integrated into your vehicle and managed by the Powertrain Control Module (PCM). Additionally, your vehicle has the ability to alert you to additional maintenance required on your vehicle or engine. Refer to the following messages that may be displayed on your Driver Information Display (DID).

### **Exhaust System — Regeneration Required Now**

This message indicates that the Diesel Particulate Filter (DPF) reached 80% of its maximum storage capacity.

By simply driving your vehicle at highway speeds for up to 20 minutes, you can remedy the condition in the particulate filter system and allow your diesel engine and exhaust after-treatment system to cleanse the filter to remove the trapped PM and restore the system to normal operating condition.

### **Exhaust System — Regeneration in Process Exhaust Filter XX% Full**

Indicates that the Diesel Particulate Filter (DPF) is self-cleaning. Maintain your current driving condition until regeneration is completed.

### **Exhaust System — Regeneration Completed**

This message indicates that the Diesel Particulate Filter (DPF) self-cleaning is completed. If this message is displayed, you will hear one chime to assist in alerting you of this condition.

### **Exhaust Service Required — See Dealer Now**

This message indicates regeneration has been disabled due to a system malfunction. The Powertrain control Module (PCM) will register a fault code and the instrument panel will display the Malfunction Indicator Light (MIL).

<b>CAUTION!</b>
See your authorized dealer, as damage to the exhaust system could occur soon with continued operation.

## Exhaust Filter Full — Power Reduced See Dealer

The PCM derates the engine in order to limit the likelihood of permanent damage to the after-treatment system. If this condition is not corrected and a dealer service is not performed, extensive exhaust after-treatment damage can occur. Have your vehicle serviced by your local authorized dealer.

### NOTE:

Failing to follow the oil change indicator, changing your oil and resetting the oil change indicator by 0 miles remaining will prevent the diesel exhaust filter from performing its cleaning routine. This will shortly result in a Malfunction Indicator Light (MIL) and reduced engine power. Only an authorized dealer will be able to correct this condition.

### CAUTION!

See your authorized dealer, as damage to the exhaust system could occur with the exhaust filter full.

## COOL-DOWN IDLE CHART

TURBO "COOL DOWN" CHART			
Driving Conditions	Load	Turbo Temp	Idle Time (in minutes) Before Shut Down
Stop and Go	Empty	Cool	Less than 1
Stop and Go	Medium	Warm	1
Highway Speeds	Medium	Warm	2
City Traffic	Max. GCWR	Warm	3
Highway Speeds	Max. GCWR	Warm	4
Uphill Grade	Max. GCWR	Hot	5

# 1500 3.0L DIESEL

## ADDING FUEL — DIESEL ENGINE ONLY

Your vehicle is equipped with a cap-less fuel system.

Most fuel cans will not open the flapper door.

A funnel is provided to open the flapper door to allow emergency refueling with a fuel can.

### Emergency Fuel Can Refueling

1. Retrieve funnel from the jack storage area under the passenger seat.
2. Insert the funnel into same filler pipe opening as the fuel nozzle.
3. Ensure the funnel is inserted fully to hold flapper door open.



#### Fill Locations

- 1 — Diesel Exhaust Fluid (DEF) Fill Location
- 2 — Diesel Fuel Fill Location

4. Pour fuel into funnel opening.
5. Remove the funnel from filler pipe, clean off prior to putting back in the jack storage area under the passenger seat.

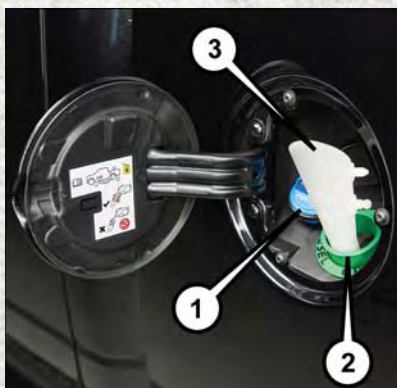

#### Fill Locations And Funnel Usage

- 1 — Diesel Exhaust Fluid (DEF) Fill Location
- 2 — Diesel Fuel Fill Location
- 3 — Emergency Diesel Fuel Fill Funnel



## DIESEL EXHAUST FLUID

Diesel Exhaust Fluid (DEF) sometimes known simply by the name of its active component, UREA – is a key component of selective catalytic reduction (SCR) systems, which help diesel vehicles meet stringent emission regulations. DEF is a liquid reducing agent that reacts with engine exhaust in the presence of a catalyst to convert smog-forming nitrogen oxides (NOx) into harmless nitrogen and water vapor.

Your vehicle is equipped with a Selective Catalytic Reduction system in order to meet the very stringent diesel emissions standards required by the Environmental Protection Agency. Selective Catalytic Reduction (SCR) is the first and only technology in decades to be as good for the environment as it is good for business and vehicle performance.

The purpose of the SCR system is to reduce levels of NOx (oxides of nitrogen emitted from engines) that are harmful to our health and the environment to an almost near-zero level. Small quantities of Diesel Exhaust Fluid (DEF) are injected into the exhaust upstream of a catalyst where, when vaporized, convert smog-forming nitrogen oxides (NOx) into harmless nitrogen (N<sub>2</sub>) and water vapor (H<sub>2</sub>O), two natural components of the air we breathe. You can operate with the comfort that your vehicle is contributing to a cleaner, healthier world environment for this and generations to come.

### System Overview

This vehicle is equipped with a Diesel Exhaust Fluid (DEF) injection system and a Selective Catalytic Reduction (SCR) catalyst to meet the emission requirements.

The DEF injection system consists of the following components:

- DEF tank
- DEF pump
- DEF injector
- Electronically-heated DEF lines
- NOx sensors
- Temperature sensors
- SCR catalyst

The DEF injection system and SCR catalyst enable the achievement of diesel emissions requirements; while maintaining outstanding fuel economy, drivability, torque and power ratings.

#### NOTE:

- Your vehicle is equipped with a DEF injection system. You may occasionally hear an audible clicking noise. This is normal operation.
- The DEF pump will run for a period of time after engine shutdown to purge the DEF system. This is normal operation.

# 1500 3.0L DIESEL

## Adding Diesel Exhaust Fluid

The DEF gauge (located in the instrument panel) will display the level of DEF remaining in the tank.

Completely fill the DEF tank through the diesel exhaust fluid fill location (located behind the fuel door) at every maintenance interval or before if prompted by the Electronic Vehicle Information Center (EVIC)/Driver Information Display (DID).

### NOTE:

- Driving conditions (altitude, vehicle speed, load, etc.) will effect the amount of DEF that is used in your vehicle.
- Since DEF will begin to freeze at 12°F (-11°C), your vehicle is equipped with an automatic DEF heating system. This allows the DEF injection system to operate properly at temperatures below 12°F (-11°C). If your vehicle is not in operation for an extended period of time with temperatures below 12°F (-11°C), the DEF in the tank may freeze. If the tank is overfilled and freezes, it could be damaged. Therefore, do not overfill the DEF tank. Extra care should be taken when filling with portable containers to avoid overfilling. Note the level of the DEF gauge in your instrument cluster. On pickup applications, you may safely add a maximum of 2 gallons of DEF from portable containers when your DEF gauge is reading ½ full.

### DEF Fill Procedure

1. Remove cap from DEF tank (located behind the fuel door on drivers side of the vehicle).
2. Insert DEF container or fill nozzle into DEF fill location and fill DEF tank.

### NOTE:

- The DEF gauge may take up to five seconds to update after adding a gallon or more of Diesel Exhaust Fluid (DEF) to the DEF tank. If you have a fault related to the DEF system, the gauge may not update to the new level. See your authorized dealer for service.



**Fill Locations**

- 1 — Diesel Exhaust Fluid (DEF) Fill Location  
2 — Diesel Fuel Fill Location
-

- The DEF gauge may also not immediately update after a refill if the temperature of the DEF fluid is below 12F (-11C). The DEF line heater will possibly warm up the DEF fluid and allow the gauge to update after a period of run time. Under very cold conditions, it is possible that the gauge may not reflect the new fill level for several drives.

3. Reinstall cap onto DEF tank.

Refer to your Diesel Supplement on the DVD for further details.

## CAUTION!

- To avoid DEF spillage and overfilling, do not “top off” the DEF tank after filling.
- When DEF is spilled, clean the area immediately with water or a mild solvent.
- **DO NOT OVERFILL.** DEF will freeze below 12 degrees F (-11 degrees C). The DEF system is designed to work in temperatures below the DEF freezing point, however, if the tank is overfilled and freezes, the system could be damaged.

## Diesel Exhaust Fluid (DEF) Warning Messages

Your vehicle will begin displaying warning messages when the DEF level reaches a driving range of approximately 500 miles (800 km).

If the following warning message sequence is ignored, your vehicle may not restart unless DEF is added within the displayed mileage shown in the DID message.

**Engine Will Not Restart in XXXX mi DEF Low Refill Soon** – This message will display when DEF driving range is less than 500 miles, DEF fluid top off is required within the displayed mileage. The message will be displayed in the DID during vehicle start up with the current allowed mileage and accompanied by a single chime. The remaining mileage can be pulled up anytime by way of the “Messages” list within the DID.

**Engine Will Not Restart in XXXX mi Refill DEF** – This message will display when DEF driving range is less than 200 miles. It is also displayed at 150 miles and 100 miles. DEF fluid top off is required within the displayed mileage. The message will be displayed in the DID during vehicle start up with an updated distance mileage, and it will be accompanied by a single chime. Stating at 100 miles, remaining range will be continuously displayed while operating the vehicle. Chimes will also accompany the 75, 50 and 25 mile remaining distances. The DEF Low telltale will be on continuously until DEF fluid is topped off.

**Engine Will Not Restart Refill DEF** – This message will display when the DEF driving range is less than 1 mile, DEF fluid top off is required or the engine will not restart. The message will be displayed in the DID during vehicle start up, and it will be accompanied by a single chime. The DEF Low telltale will be illuminated continuously until DEF fluid tank is filled with a minimum of two gallons of DEF.

## Diesel Exhaust Fluid (DEF) Fault Warning Messages

There are different messages which are displayed if the vehicle detects that the DEF system has been filled with a fluid other than DEF, has experienced component failures, or when tampering has been detected.

When the DEF system needs to be serviced the following warnings will display:

**Service DEF System See Dealer** – This message will display when the fault is initially detected and each time the vehicle is started. The message will be accompanied by a single chime and the Malfunction Indicator Light. We recommend you drive to your nearest authorized dealer and have your vehicle serviced immediately. If not corrected in 50 miles, vehicle will enter the “Engine Will not restart in XXXmi Service DEF See dealer” warning stage and message.

**Incorrect DEF Detected See Dealer** – This message will display if the DEF system has detected the incorrect fluid has been introduced to the DEF tank. The message will be accompanied by a single chime. We recommend you drive to your nearest authorized dealer and have your vehicle serviced immediately. If not corrected in 50 miles, vehicle will enter the Engine Will not restart in XXX mi Service DEF See dealer warning stage and message.

**Engine Will Not Restart in XXX mi Service DEF See Dealer** – This message is first displayed if the fault detected is not serviced after 50 miles of operation. It is also displayed at 150 miles 125 miles and 100 miles. System service is required within the displayed mileage. The message will be displayed in the DID during vehicle start up with an updated distance mileage, and it will be accompanied by a single chime. Starting at 100 miles, remaining range will be continuously displayed while operating the vehicle. Chimes will also accompany the 75, 50 and 25 mile remaining distances. We recommend you drive to your nearest authorized dealer and have your vehicle serviced immediately.

**Engine Will Not Restart Service DEF System See Dealer** – This message will display if the DEF system issue detected is not serviced during the allowed period. Your engine will not restart unless your vehicle is serviced by your authorized dealer. This message will be displayed when under 1 mile until the engine will not start and each time the vehicle is started. The message will be continuously displayed and be accompanied by a single chime. Your Malfunction Indicator Light will also be continuously illuminated. We highly recommend you drive to your nearest authorized dealer immediately if the message appears while engine is running.

**Engine Will Not Start Service DEF System See Dealer** – This message will display when the fault detected is not serviced after the Engine will not restart Service DEF System See Dealer message is displayed on the next subsequent restart. Your engine will not start unless you vehicle is serviced by your authorized dealer. The message will be accompanied by a single chime. Your Malfunction Indicator Light will be continuously illuminated. If the message appears and you can not start the engine, we recommend you have your vehicle towed to your nearest authorized dealer immediately.

## DIESEL ENGINE BREAK-IN RECOMMENDATIONS

The Cummins turbocharged diesel engine does not require a break-in period due to its construction. Normal operation is allowed, providing the following recommendations are followed:

- Warm up the engine before placing it under load.
- Do not operate the engine at idle for prolonged periods.
- Use the appropriate transmission gear to prevent engine lugging.
- Observe vehicle oil pressure and temperature indicators.
- Check the coolant and oil levels frequently.
- Vary throttle position at highway speeds when carrying or towing significant weight.

### **NOTE:**

Light duty operation such as light trailer towing or no load operation will extend the time before the engine is at full efficiency. Reduced fuel economy and power may be seen at this time.

Because of the construction of the Cummins turbocharged diesel engine, engine run-in is enhanced by loaded operating conditions which allow the engine parts to achieve final finish and fit during the first 6,000 miles (10 000 km).

## DIESEL ENGINE STARTING PROCEDURES

### **Engine Block Heater**

For ambient temperatures below 0°F (-18°C), engine block heater usage is recommended.

For ambient temperatures below -20°F (-29°C), engine block heater usage is required.

The engine block heater cord is routed under the hood to the right side and can be located just behind the grille near the headlamp.

Connect the heater cord to a ground-fault interrupter protected 110–115 volt AC electrical outlet with a grounded, three-wire extension cord.

### **NOTE:**

The block heater will require 110 volts AC and 6.5 amps to activate the heater element.

The block heater must be plugged in at least one hour to have an adequate warming effect on the coolant.

# 6.7L CUMMINS DIESEL

## Water In Fuel Message

If a Water In Fuel message or  indicator appears in the cluster and a chime sounds five times, the fuel/water separator will need to be drained immediately to prevent engine damage.

Refer to “Draining Fuel Water Separator” in this guide for draining instructions or see your dealer.

## Cold Start Procedure

Turn the ignition switch to the ON position. If the Wait To Start  light appears in the cluster, wait for the light to turn off before starting.

In extremely cold weather below 0°F (-18°C) it may be beneficial to cycle the manifold heaters twice before attempting to start the engine. This can be accomplished by turning the ignition OFF for at least five seconds and then back ON after the “Wait To Start Light” has turned off, but before the engine is started. However, excessive cycling of the manifold heaters will result in damage to the heater elements or reduced battery voltage.

Refer to the Owner's Manual Diesel Supplement on the DVD for further details.

## Winter Front Usage

A winter front or cold weather cover is to be used in ambient temperatures below 32°F (0°C), especially during extended idle conditions to reduce condensation build-up within engine crankcase. If a winter front or cold weather cover is to be used, a percentage of the total grille opening area must be left uncovered to provide sufficient air flow to the charge air cooler and automatic transmission oil cooler. The percentage of opening must be increased with the increasing ambient air temperature and/or engine load. If the cooling fan can be heard cycling frequently, increase the size of the opening in the winter front. A suitable cold weather cover is available from your MOPAR dealer.

## Engine Idling

Avoid prolonged engine idling. Long periods of idling may be harmful to your engine because combustion chamber temperatures can drop so low that the fuel may not burn completely.

Incomplete combustion allows carbon and varnish to form on piston rings, engine valves, and injector nozzles. Also, the unburned fuel can enter the crankcase, diluting the oil and causing rapid wear to the engine.

# 6.7L CUMMINS DIESEL

If the engine is allowed to idle, under some conditions the idle speed may increase to 900 RPM then return to normal idle speed. This is normal operation.

## WARNING!

Remember to disconnect the cord before driving. Damage to the 110–115 volt electrical cord could cause electrocution.

## DIESEL EXHAUST BRAKE (ENGINE BRAKING)

The Exhaust Brake switch is located on the switch bank below the audio system. This switch is used to enable exhaust brake modes.

Pushing the exhaust brake switch once will enable full strength exhaust brake mode, indicated by a yellow icon in the EVIC/DID. This mode applies full exhaust braking when the accelerator pedal is released. This is most useful for slowing the vehicle.

Pushing the exhaust brake switch again will enable the Smart Brake feature, indicated by a green icon in the EVIC/DID. This feature is intended to maintain the vehicle speed present when the accelerator pedal is released. However, when the brakes are applied, full exhaust braking is still enabled to slow the vehicle.

A third push of the brake switch will turn the exhaust brake off, and will extinguish the exhaust brake icon in the EVIC/DID.

### NOTE:

In general, higher engine speeds result in higher exhaust braking force. For optimum braking power, it is recommended to use the exhaust brake while in TOW/HAUL mode.

## CAUTION!

Use of aftermarket exhaust brakes is not recommended and could lead to engine damage.

## WARNING!

Do not use the exhaust brake feature when driving in icy or slippery conditions as the increased engine braking can cause the rear wheels to slide and the vehicle to swing around with the possible loss of vehicle control, which may cause a collision possibly resulting in personal injury or death.

# 6.7L CUMMINS DIESEL

## IDLE-UP FEATURE (AUTOMATIC TRANSMISSION ONLY)



Speed Control Switches

- 1 — Push CANCEL
  - 2 — Push ON/OFF
  - 3 — Push Resume/Accel
  - 4 — Push Set/Decel
- 

The Idle-Up Feature uses the speed control switches to increase engine idle speed and quickly warm the vehicle's interior. This feature must be enabled by your dealer. See your local dealer.

With the transmission in PARK, the parking brake applied, and the engine running, push the speed control ON/OFF switch on, then push the SET switch.

The engine RPM will go up to 1100 RPM. To increase the RPM, push and hold the RESUME/ACCEL switch and the idle speed will increase to approximately 1500 RPM. To decrease the RPM, push and hold the SET/DECEL switch and the idle speed will decrease to approximately 1100 RPM.

To cancel the Idle Up Feature, either push the CANCEL switch, push the ON/OFF switch or push the brake pedal.



## ENGINE MOUNTED FUEL FILTER/WATER SEPARATOR

### Draining Fuel/Water Separator

If the “Water in Fuel” indicator light  is illuminated and an audible chime is heard five times, you should stop the engine and drain the water from the separator. The drain is located on the bottom of the Fuel Filter and Water Separator assembly which is located on the driver's side of the engine.

Turn the drain valve (located on the side of the filter) counterclockwise 1/4 turn, then turn the ignition switch to the ON/RUN position to allow any accumulated water to drain.

When clean fuel is visible, close the drain and switch the ignition to OFF.

Refer to the Diesel Supplement on the DVD for further details.

### Fuel Filter Replacement

1. With the engine off and a drain pan under the fuel filter drain hose, open the water drain valve 1/4 turn counterclockwise and completely drain fuel and water into the approved container.
2. Close the water drain valve and remove the lid using a socket or strap wrench; rotate counterclockwise for removal. Remove the used o-ring and discard it.
3. Remove the used filter cartridge from the housing and dispose of according to your local regulations.
4. Wipe clean the sealing surfaces of the lid and housing and install the new o-ring into ring groove on the filter housing and lubricate with clean engine oil.
5. Install a new filter in the housing. Push down on the cartridge to ensure it is properly seated. **Do not pre-fill the filter housing with fuel.**
6. Install the lid onto the housing and tighten to 22.5 ft lbs (30.5 N-m). Do not overtighten the lid.
7. Start the engine and confirm no leaks are present.

The engine mounted filter housing is equipped with a No-Filter-No-Run (NFNR) feature. Engine will not run if:

- No filter is installed.
- Inferior/Non-approved filter is used. Use of OEM filter is required to ensure vehicle will run.

#### CAUTION!

- Diesel fuel will damage blacktop paving surfaces. Drain the filter into an appropriate container.
- Do not prefill the fuel filter when installing a new fuel filter. There is a possibility debris could be introduced into the fuel filter during this action. It is best to install the filter dry and allow the in-tank lift pump to prime the fuel system.
- If the “Water In Fuel Indicator Light” remains on, DO NOT START the engine before you drain water from the fuel filter to avoid engine damage.

# 6.7L CUMMINS DIESEL

## UNDERBODY MOUNTED FUEL FILTER/WATER SEPARATOR

### Draining Fuel/Water Separator

If the “Water in Fuel” indicator light  is illuminated and an audible chime is heard five times, you should stop the engine and drain the water from the separator.

The drain is located on the bottom of the Fuel Filter and Water Separator assembly which is located in front of the rear axle above the drive shaft on pick up models. The Chassis Cab models second filter location is on the frame behind the front axle. The best access to this water drain valve is from under the vehicle.

- Turn the drain valve (located on the side of the filter) counterclockwise 1 full turn, then turn the ignition switch to the ON/RUN position to allow any accumulated water to drain.
- When clean fuel is visible, close the drain and switch the ignition to OFF.
- Refer to the Diesel Supplement on the DVD for further details.

### Underbody Fuel Filter Replacement

1. With the engine off and a drain pan under the fuel filter drain hose, open the water drain valve 1 full turn counterclockwise and completely drain fuel and water into the approved container.
2. Close the water drain valve and remove the lid using a socket or strap wrench; rotate counterclockwise for removal. Remove the used o-ring and discard it.
3. Remove the used filter cartridge from the housing and dispose of according to your local regulations.
4. Wipe clean the sealing surfaces of the lid and housing and install the new o-ring into ring groove on the filter housing and lubricate with clean engine oil.
5. Install a new filter in the housing. Push down on the cartridge to ensure it is properly seated. **Do not pre-fill the filter housing with fuel.**
6. Start the engine and confirm no leaks are present.

The underbody mounted filter housing will cause the engine not to run if:

- No filter is installed.

#### NOTE:

- Using a fuel filter that does not meet the manufacturer's filtration and water separating requirements can severely impact fuel system life and reliability.
- The WIF sensor is re-usable. Service kit comes with new o-ring for filter canister and WIF sensor.

## CAUTION!

- Diesel fuel will damage blacktop paving surfaces. Drain the filter into an appropriate container.
- Do not prefill the fuel filter when installing a new fuel filter. There is a possibility debris could be introduced into the fuel filter during this action. It is best to install the filter dry and allow the in-tank lift pump to prime the fuel system.
- If the “Water In Fuel Indicator Light” remains on, DO NOT START the engine before you drain water from the fuel filter to avoid engine damage.

## EXHAUST REGENERATION

Under certain conditions, your Cummins diesel engine and exhaust after-treatment system may never reach the conditions required to remove the trapped particulate matter. If this occurs, the “Exhaust System — Regeneration Required Now” message will be displayed on the EVIC/DID screen in your cluster and you will hear one chime to alert you of this condition. Driving your vehicle at highway speeds for as little as 45 minutes can remedy the condition and allow the engine and exhaust after-treatment system to remove the trapped particulate matter.

### NOTE:

Under typical operating conditions, NO indications of regeneration state will be displayed. If you do reach 80% of filter capacity, the following messages will assist you in inducing and understanding the regeneration process.

## Perform Service

Your vehicle will require emissions maintenance at a set interval. To help remind you when this maintenance is due, the Electronic Vehicle Information Center (EVIC)/Driver Information Display (DID) will display “Perform Service”. When the “Perform Service” message is displayed on the EVIC/DID it is necessary to have the emissions maintenance performed. Emissions maintenance may include replacing the Closed Crankcase Ventilation (CCV) filter element, and cleaning of the EGR Cooler. The procedure for clearing and resetting the “Perform Service” indicator message is located in the appropriate Service Information.

## Exhaust System — Regeneration Required Now

“Exhaust System — Regeneration Required Now” will be displayed on the EVIC/DID if the exhaust particulate filter reaches 80% of its maximum storage capacity.

## Exhaust Filter XX% Full

Indicates that the Diesel Particulate Filter (DPF) is approaching full.

# 6.7L CUMMINS DIESEL

## **Exhaust System — Regeneration in Process Exhaust Filter XX% Full**

Indicates that the Diesel Particulate Filter (DPF) is self-cleaning. Maintain your current driving condition until regeneration is completed.

## **Exhaust System — Regeneration Completed**

This message indicates that the Diesel Particulate Filter (DPF) self-cleaning is completed. If this message is displayed, you will hear one chime to assist in alerting you of this condition.

## **Exhaust Service Required — See Dealer Now**

This message indicates regeneration has been disabled due to a system malfunction. The Powertrain control Module (PCM) will register a fault code and the instrument panel will display the Malfunction Indicator Light (MIL).

### **CAUTION!**

See your authorized dealer, as damage to the exhaust system could occur soon with continued operation.

## **Exhaust Filter Full — Power Reduced See Dealer**

The PCM derates the engine in order to limit the likelihood of permanent damage to the after-treatment system. If this condition is not corrected and a dealer service is not performed, extensive exhaust after-treatment damage can occur. Have your vehicle serviced by your local authorized dealer.

### **NOTE:**

Failing to follow the oil change indicator, changing your oil and resetting the oil change indicator by 0 miles remaining will prevent the diesel exhaust filter from performing its cleaning routine. This will shortly result in a Malfunction Indicator Light (MIL) and reduced engine power. Only an authorized dealer will be able to correct this condition.

### **CAUTION!**

See your authorized dealer, as damage to the exhaust system could occur with the exhaust filter full.

# 6.7L CUMMINS DIESEL

## COOL-DOWN IDLE CHART

TURBO "COOL DOWN" CHART			
Driving Conditions	Load	Turbo Temp	Idle Time (in minutes) Before Shut Down
Stop and Go	Empty	Cool	Less than 1
Stop and Go	Medium	Warm	1
Highway Speeds	Medium	Warm	2
City Traffic	Max. GCWR	Warm	3
Highway Speeds	Max. GCWR	Warm	4
Uphill Grade	Max. GCWR	Hot	5

## ADDING FUEL — DIESEL ENGINE ONLY

Your vehicle is equipped with a cap-less fuel system.

Most fuel cans will not open the flapper door.

A funnel is provided to open the flapper door to allow emergency refueling with a fuel can.

### Emergency Fuel Can Refueling

1. Retrieve funnel from the jack storage area under the passenger seat.
2. Insert the funnel into same filler pipe opening as the fuel nozzle.
3. Ensure the funnel is inserted fully to hold flapper door open.



### Fill Locations

- 1 — Diesel Exhaust Fluid (DEF) Fill Location  
2 — Diesel Fuel Fill Location

# 6.7L CUMMINS DIESEL

4. Pour fuel into funnel opening.
5. Remove the funnel from filler pipe, clean off prior to putting back in the jack storage area under the passenger seat.



**Fill Locations And Funnel Usage**

- 1 — Diesel Exhaust Fluid (DEF) Fill Location
- 2 — Diesel Fuel Fill Location
- 3 — Emergency Diesel Fuel Fill Funnel

## DIESEL EXHAUST FLUID

Diesel Exhaust Fluid (DEF) sometimes known simply by the name of its active component, UREA – is a key component of selective catalytic reduction (SCR) systems, which help diesel vehicles meet stringent emission regulations. DEF is a liquid reducing agent that reacts with engine exhaust in the presence of a catalyst to convert smog-forming nitrogen oxides (NOx) into harmless nitrogen and water vapor.

Your vehicle is equipped with a Selective Catalytic Reduction system in order to meet the very stringent diesel emissions standards required by the Environmental Protection Agency. Selective Catalytic Reduction (SCR) is the first and only technology in decades to be as good for the environment as it is good for business and vehicle performance.

The purpose of the SCR system is to reduce levels of NOx (oxides of nitrogen emitted from engines) that are harmful to our health and the environment to an almost near-zero level. Small quantities of Diesel Exhaust Fluid (DEF) are injected into the exhaust upstream of a catalyst where, when vaporized, convert smog-forming nitrogen oxides (NOx) into harmless nitrogen (N<sub>2</sub>) and water vapor (H<sub>2</sub>O), two natural components of the air we breathe. You can operate with the comfort that your vehicle is contributing to a cleaner, healthier world environment for this and generations to come.

## System Overview

This vehicle is equipped with a Diesel Exhaust Fluid (DEF) injection system and a Selective Catalytic Reduction (SCR) catalyst to meet the emission requirements.

The DEF injection system consists of the following components:

- DEF tank
- DEF pump
- DEF injector
- Electronically-heated DEF lines
- DEF control module
- NOx sensors
- NH3 sensor
- Temperature sensors
- SCR catalyst

The DEF injection system and SCR catalyst enable the achievement of diesel emissions requirements; while maintaining outstanding fuel economy, drivability, torque and power ratings.

### NOTE:

- Your vehicle is equipped with a DEF injection system. You may occasionally hear an audible clicking noise. This is normal operation.
- The DEF pump will run for a period of time after engine shutdown to purge the DEF system. This is normal operation.

## Diesel Exhaust Fluid Storage

Diesel Exhaust Fluid (DEF) is considered a very stable product with a long shelf life. If DEF is kept in temperatures between 10° to 90°F (-12° to 32°C), it will last a minimum of one year.

DEF is subject to freezing at the lowest temperatures. For example, DEF may freeze at temperatures at or below 12°F (-11°C). The system has been designed to operate in this environment.

### NOTE:

When working with DEF, it is important to know that:

- Any containers or parts that come into contact with DEF must be DEF compatible (plastic or stainless steel). Copper, brass, aluminum, iron or non-stainless steel should be avoided as they are subject to corrosion by DEF.
- If DEF is spilled, it should be wiped up completely.

# 6.7L CUMMINS DIESEL

## Adding Diesel Exhaust Fluid

The DEF gauge (located in the instrument cluster) will display the level of DEF remaining in the tank.

Completely fill the DEF tank through the diesel exhaust fluid fill location at every maintenance interval or before if prompted by the Electronic Vehicle Information Center (EVIC)/Driver Information Display (DID).

### NOTE:

- Driving conditions (altitude, vehicle speed, load, etc.) will effect the amount of DEF that is used in your vehicle.
- Since DEF will begin to freeze at 12°F (-11°C), your vehicle is equipped with an automatic DEF heating system. This allows the DEF injection system to operate properly at temperatures below 12°F (-11°C). If your vehicle is not in operation for an extended period of time with temperatures below 12°F (-11°C), the DEF in the tank may freeze. If the tank is overfilled and freezes, it could be damaged. Therefore, do not overfill the DEF tank. Extra care should be taken when filling with portable containers to avoid overfilling. Note the level of the DEF gauge in your instrument cluster. On pickup applications, you may safely add a maximum of 2 gallons (7.5 liters) of DEF from portable containers when your DEF gauge is reading  $\frac{1}{2}$  full. On Chassis Cab applications a maximum of 2 gallons (7.5 liters) may be added when the DEF gauge is reading  $\frac{3}{4}$  full.

### DEF Fill Procedure

1. Remove cap from DEF tank (located behind the fuel door on drivers side of the vehicle).
2. Insert DEF container or fill nozzle into DEF fill location and fill DEF tank.
3. Reinstall cap onto DEF tank.

Refer to your Diesel Supplement on the DVD for further details.



**Fill Locations**

- 1 — Diesel Exhaust Fluid (DEF) Fill Location
- 2 — Diesel Fuel Fill Location



## CAUTION!

- To avoid DEF spillage and overfilling, do not “top off” the DEF tank after filling.
- When DEF is spilled, clean the area immediately with water or a mild solvent.
- DO NOT OVERFILL. DEF will freeze below 12 degrees F (-11 degrees C). The DEF system is designed to work in temperatures below the DEF freezing point, however, if the tank is overfilled and freezes, the system could be damaged.

## Diesel Exhaust Fluid (DEF) Warning Messages

Your vehicle will begin displaying warning messages when the DEF level reaches a driving range of approximately 350 miles (563 km). If the following warning message sequence is ignored, your vehicle may be limited to a maximum speed of 5 mph (8 km/h) unless DEF is added.

**DEF Low Refill Soon** — This message will display when the low level is reached, during vehicle start up, and with increased frequency during vehicle operation. It will be accompanied by a single chime. Approximately 5 gallons (19 liters) of DEF is required to refill the tank when this message is initially displayed on pickup applications, and approximately 7 gallons (28 liters) are required on chassis-cab applications.

**Speed Limited to 5 MPH in XXX mi Refill DEF** — This message will continuously display if the “DEF Low Refill Soon” message is ignored, and the frequency of occurrence of the chime will increase unless up to 2 gallons (7.5 liters) of DEF is added to the tank.

**5 MPH Max Speed on Restart, Long Idle or Refuel Refill DEF** — This message will continuously display when the counter reaches zero, and will be accompanied by a periodic chime.

The vehicle will only be capable of a maximum speed of 5 mph (8 km/h) upon the first of the following conditions to occur:

- If the vehicle is shutoff and restarted.
- If the vehicle is idled for an extended period of time, approximately one hour or greater.
- If the system detects that the level of fuel in the tank has increased.

Add a minimum of 2 gallons (7.5 liters) of DEF to the tank in order to avoid vehicle operation at a maximum speed of 5 mph (8 km/h).

**5 MPH Max Speed Refill DEF** — The vehicle will only be capable of a maximum speed of 5 mph (8 km/h) when this message is displayed. Add up to 2.5 gallons (7.5 liters) of DEF to the tank to restore normal vehicle operation.

### NOTE:

A minimum of 2 gallons (7.5 liters) may be required to restore normal vehicle operation. Although the vehicle will start normally and can be placed in gear after this message has been initially displayed, extreme caution should be utilized since the vehicle will only be capable of maneuvering at a maximum speed of 5 mph (8 km/h).

# 6.7L CUMMINS DIESEL

## Diesel Exhaust Fluid (DEF) Fault Warning Messages

There are four different messages which are displayed if the vehicle detects that the DEF system has been filled with a fluid other than DEF, has experienced component failures, or when tampering has been detected. The vehicle may be limited to a maximum speed of 5 mph (8 km/h) if the DEF system is not serviced within less than 250 miles (402 kilometers) of the fault being detected.

When the DEF system needs to be serviced the following warnings will display:

**Service DEF System – See Dealer** — This message will display when the fault is initially detected, each time the vehicle is started, and periodically during driving. The message will be accompanied by a single chime. We recommend you drive to your nearest authorized dealer and have your vehicle serviced as soon as possible.

**5 MPH Max Speed in 150 mi Service DEF System See Dealer** — This message will display if the DEF system has not been serviced after the “Service DEF System – See Dealer” message is displayed. This message will continuously display until the mileage counter reaches zero, and will be accompanied by a periodic chime. The message will continue to countdown until it reaches zero unless the vehicle is serviced. We recommend you drive to your nearest authorized dealer and have your vehicle serviced immediately.

### NOTE:

Under some circumstances this mileage counter may start with a value of less than 150 miles (241 kilometers). For example, if recurring faults are detected in a time interval of less than 40 hours, the counter may restart at the value where it stopped when a previous fault was temporarily remedied, or at a minimum of 50 miles (80 kilometers).

**5 MPH Max Speed on Restart, Long Idle or Refuel Service DEF See Dealer** — This message will continuously display when the mileage counter reaches zero, and will be accompanied by a periodic chime.

The vehicle will only be capable of a maximum speed of 5 mph (8 km/h) upon the first of the following conditions to occur:

- If the vehicle is shutoff and restarted.
- If the vehicle is idled for an extended period of time, approximately one hour or greater.
- If the system detects that the level of fuel in the tank has increased.

**5 MPH Max Speed Service DEF System See Dealer** — This message will continuously display, and will be accompanied by a periodic chime. Although the vehicle can be started and placed in gear, the vehicle will only operate at a maximum speed of 5 mph (8 km/h). Your vehicle will require towing, see your authorized dealer for service.

### NOTE:

When this message is displayed, the engine can still be started. However, the vehicle will only operate at a maximum speed of 5 mph (8 km/h).

# WHAT TO DO IN EMERGENCIES

## ROADSIDE ASSISTANCE

Dial toll-free 1-800-521-2779 for U.S. Residents or 1-800-363-4869 for Canadian Residents.

- Provide your name, vehicle identification number, license plate number, and your location, including the telephone number from which you are calling.
- Briefly describe the nature of the problem and answer a few simple questions.
- You will be given the name of the service provider and an estimated time of arrival. If you feel you are in an “unsafe situation”, please let us know. With your consent, we will contact local police or safety authorities.

## INSTRUMENT CLUSTER WARNING LIGHTS

### - Electronic Stability Control (ESC) Activation/Malfunction Indicator Light

If this indicator light flashes during acceleration, apply as little throttle as possible. While driving, ease up on the accelerator. Adapt your speed and driving to the prevailing road conditions. To improve the vehicle's traction when starting off in deep snow, sand or gravel, it may be desirable to switch the ESC system off.

### - Tire Pressure Monitoring System (TPMS) Light

Each tire, including the spare (if provided), should be checked monthly, when cold and inflated to the inflation pressure recommended by the vehicle manufacturer on the vehicle placard or tire inflation pressure label. (If your vehicle has tires of a different size than the size indicated on the vehicle placard or tire inflation pressure label, you should determine the proper tire inflation pressure for those tires.)

As an added safety feature, your vehicle has been equipped with a Tire Pressure Monitoring System (TPMS) which display in the Electronic Vehicle Information Center (EVIC) or Driver Information Display (DID) when one or more of your tires is significantly under-inflated. Accordingly, when the low tire pressure EVIC or DID display illuminates, you should stop and check your tires as soon as possible, and inflate them to the proper pressure. Driving on a significantly under-inflated tire causes the tire to overheat and can lead to tire failure. Under-inflation also reduces fuel efficiency and tire tread life, and may affect the vehicle's handling and stopping ability.

**IF THE LIGHT STARTS FLASHING INDICATING A LOW TIRE PRESSURE, ADJUST THE AIR PRESSURE IN THE LOW TIRE TO THE AIR PRESSURE SHOWN ON THE VEHICLE PLACARD OR TIRE INFLATION PRESSURE LABEL LOCATED ON THE DRIVER'S DOOR.**

#### **NOTE:**

**After inflation, the vehicle may need to be driven for 20 minutes before the flashing light will turn off.**

# WHAT TO DO IN EMERGENCIES

Please note that the TPMS is not a substitute for proper tire maintenance, and it is the driver's responsibility to maintain correct tire pressure, even if under-inflation has not reached the level to trigger illumination of the TPMS low EVIC or DID display.

Your vehicle has also been equipped with a TPMS malfunction indicator to indicate when the system is not operating properly. The TPMS malfunction indicator is combined with the low tire pressure telltale. When the system detects a malfunction, the telltale will flash for approximately one minute and then remain continuously illuminated. This sequence will continue each time the vehicle is restarted as long as the malfunction exists.

When the malfunction indicator is illuminated, the system may not be able to detect or signal low tire pressure as intended. TPMS malfunctions may occur for a variety of reasons, including the installation of replacement or alternate tires or wheels on the vehicle that prevent the TPMS from functioning properly. Always check the TPMS malfunction telltale after replacing one or more tires or wheels on your vehicle, to ensure that the replacement or alternate tires and wheels allow the TPMS to continue to function properly.

## NOTE:

Tire pressures change by approximately 1 psi (7 kPa) per 12° F (7° C) of air temperature change. Keep this in mind when checking tire pressure inside a garage, especially in the Winter. Example: If garage temperature is 68°F (20°C) and the outside temperature is 32°F (0°C), then the cold tire inflation pressure should be increased by 3 psi (21 kPa), which equals 1 psi (7 kPa) for every 12°F (7°C) for this outside temperature condition.

## CAUTION!

The TPMS has been optimized for the original equipment tires and wheels. TPMS pressures and warning have been established for the tire size equipped on your vehicle. Undesirable system operation or sensor damage may result when using replacement equipment that is not of the same size, type, and/or style. Aftermarket wheels can cause sensor damage. Do not use tire sealant from a can, or balance beads if your vehicle is equipped with a TPMS, as damage to the sensors may result.

## - Engine Temperature Warning Light

This light warns of an overheated engine condition.

If the light turns on and a warning chime sounds while driving, safely pull over and stop the vehicle. If the A/C system is on, turn it off. Also, shift the transmission into NEUTRAL and idle the vehicle. If the temperature reading does not return to normal, turn the engine off immediately.

We recommend that you do not operate the vehicle or engine damage will occur. Have the vehicle serviced immediately.

# WHAT TO DO IN EMERGENCIES

## WARNING!

A hot engine cooling system is dangerous. You or others could be badly burned by steam or boiling coolant.

## **BRAKE – Brake Warning Light**

This light monitors various brake functions, including brake fluid level and parking brake application. If the brake light turns on, it may indicate that the parking brake is applied, that the brake fluid level is low, or that there is a problem with the brake system master cylinder reservoir.

If the light remains on when the parking brake has been disengaged, and the fluid level is at the full mark on the master cylinder reservoir, it indicates a possible brake hydraulic system malfunction or that a problem with the Brake Booster has been detected by the Anti-Lock Brake System (ABS)/Electronic Stability Control (ESC) system. In this case, the light will remain on until the condition has been corrected. If the problem is related to the brake booster, the ABS pump will run when applying the brake, and a brake pedal pulsation may be felt during each stop.

The dual brake system provides a reserve braking capacity in the event of a failure to a portion of the hydraulic system. A leak in either half of the dual brake system is indicated by the Brake Warning Light, which will turn on when the brake fluid level in the master cylinder has dropped below a specified level. The light will remain on until the cause is corrected.

Vehicles equipped with the Anti-Lock Brake System (ABS) are also equipped with Electronic Brake Force Distribution (EBD). In the event of an EBD failure, the Brake Warning Light will turn on along with the ABS Light. Immediate repair to the ABS system is required.

Operation of the Brake Warning Light can be checked by turning the ignition switch from the OFF position to the ON/RUN position. The light should illuminate for approximately two seconds. The light should then turn off unless the parking brake is applied or a brake fault is detected. If the light does not illuminate, have the light inspected by an authorized dealer.

The light also will turn on when the parking brake is applied with the ignition switch in the ON/RUN position.

### **NOTE:**

This light shows only that the parking brake is applied. It does not show the degree of brake application.

## WARNING!

Driving a vehicle with the red brake light on is dangerous. Part of the brake system may have failed. It will take longer to stop the vehicle. You could have a collision. Have the vehicle checked immediately.

# WHAT TO DO IN EMERGENCIES

## - Malfunction Indicator Light (MIL)

The Malfunction Indicator Light (MIL) is part of an onboard diagnostic system called OBD II that monitors engine and automatic transmission control systems. The light will illuminate when the key is in the ON/RUN position before engine start. If the bulb does not come on when turning the key from OFF to ON/RUN, have the condition checked promptly.

Certain conditions, poor fuel quality, etc., may illuminate the light after engine start. The vehicle should be serviced if the light stays on through several of your typical driving cycles. In most situations, the vehicle will drive normally and will not require towing.

### CAUTION!

Prolonged driving with the Malfunction Indicator Light (MIL) on could cause damage to the engine control system. It also could affect fuel economy and driveability. If the MIL is flashing, severe catalytic converter damage and power loss will soon occur. Immediate service is required.

### WARNING!

A malfunctioning catalytic converter, as referenced above, can reach higher temperatures than in normal operating conditions. This can cause a fire if you drive slowly or park over flammable substances such as dry plants, wood, cardboard, etc. This could result in death or serious injury to the driver, occupants or others.

## - Electronic Stability Control (ESC) OFF Indicator Light

The ESC OFF indicator will illuminate when the Electronic Stability Control (ESC) is turned off.

## - Charging System Light

This light shows the status of the electrical charging system. If the charging system light remains on, it means that the vehicle is experiencing a problem with the charging system.

We recommend you do not continue driving if the charging system light is on. Have the vehicle serviced immediately.

## - Oil Pressure Warning Light

This light indicates low engine oil pressure. If the light turns on while driving, stop the vehicle and shut off the engine as soon as possible. A chime will sound for four minutes when this light turns on.

We recommend you do not operate the vehicle or engine damage will occur. Have the vehicle serviced immediately.

# WHAT TO DO IN EMERGENCIES

## - Anti-Lock Brake (ABS) Light

This light monitors the Anti-Lock Brake System (ABS). The light will turn on when the ignition switch is turned to the ON/RUN position and may stay on for as long as four seconds.

If the ABS light remains on or turns on while driving, it indicates that the Anti-Lock portion of the brake system is not functioning and that service is required. However, the conventional brake system will continue to operate normally if the BRAKE warning light is not on.

If the ABS light is on, the brake system should be serviced as soon as possible to restore the benefits of Anti-Lock brakes. If the ABS light does not turn on when the ignition switch is turned to the ON/RUN position, have the light inspected by an authorized dealer.

## - Electronic Throttle Control (ETC) Light

This light informs you of a problem with the Electronic Throttle Control (ETC) system.

If a problem is detected, the light will come on while the engine is running. Cycle the ignition when the vehicle has completely stopped and the shift lever is placed in the PARK position; the light should turn off.

If the light remains lit with the engine running, your vehicle will usually be drivable; however, see an authorized service center immediately. If the light is flashing when the engine is running, immediate service is required and you may experience reduced performance, an elevated/rough idle or engine stall and your vehicle may require towing.

## - Air Bag Warning Light

This light will turn on for four to eight seconds as a bulb check when the ignition switch is first turned to the ON/RUN position. If the light is either not on during starting, stays on, or turns on while driving, have the system inspected at an authorized dealer as soon as possible. Refer to “Occupant Restraints” in “Things To Know Before Starting Your Vehicle” in your Owner’s Manual on the DVD for further information.

### **NOTE:**

The Air Bag System is designed to be maintenance free.

## - SERV (Service) 4WD Indicator Light

The SERV 4WD light monitors the electric shift four-wheel drive system. If the SERV 4WD light stays on or comes on during driving, it means that the four-wheel drive system is not functioning properly and that service is required.

For vehicles equipped with a premium cluster, this indicator will display in the Driver Information Display (DID).

# WHAT TO DO IN EMERGENCIES

## - Transmission Temperature Warning Light

This light indicates that there is excessive transmission fluid temperature that might occur with severe usage such as trailer towing. If this light turns on, stop the vehicle and run the engine at idle, with the transmission in NEUTRAL, until the light turns off. Once the light turns off, you may continue to drive normally.

### CAUTION!

Continuous driving with the Transmission Temperature Warning Light illuminated will eventually cause severe transmission damage or transmission failure.

### WARNING!

If you continue operating the vehicle when the Transmission Temperature Warning Light is illuminated you could cause the fluid to boil over, come in contact with hot engine or exhaust components and cause a fire.

## Oil Change Indicator

### Message

If an “oil change” message (shown as “Change Oil Soon” and “Oil Change Needed”) appears and a single chime sounds, it is time for your next required oil change.

### Resetting The Light After Servicing

1. Turn the ignition switch to the ON/RUN position (do not start engine).
2. Fully depress the accelerator pedal three times within 10 seconds.
3. Turn the ignition switch to the OFF/LOCK position.

## - Low Coolant Level Indicator Light

This light indicates low coolant level. If the light turns on while driving, stop the vehicle and shut off the engine as soon as possible.

We recommend you do not operate the vehicle or engine damage will occur. Have the vehicle serviced immediately.



# WHAT TO DO IN EMERGENCIES

## INSTRUMENT CLUSTER INDICATOR LIGHTS

### – Turn Signal Indicator

The arrows will flash with the exterior turn signals when the turn signal lever is operated. A tone will chime, and a EVIC/DID message will appear if either turn signal is left on for more than 1 mile (1.6 km).

#### NOTE:

If either indicator flashes at a rapid rate, check for a defective outside light bulb.

### – High Beam Indicator

Indicates that headlights are on high beam.

### – Park/Headlight ON Indicator

This indicator will illuminate when the park lights or headlights are turned on.

### – Front Fog Light Indicator

This indicator will illuminate when the front fog lights are on.

### – Vehicle Security Light

This light will flash rapidly for approximately 15 seconds when the vehicle security alarm is arming. The light will flash at a slower speed continuously after the alarm is set. The security light will also come on for about three seconds when the ignition is first turned on.

### – Tow/Haul Mode

Indicates that the Tow/Haul Mode is active.

### – Four Wheel Drive Auto

Indicates that the Four Wheel Drive has engaged automatically.

### – Electronic Stability Control OFF

This light indicates the ESC system has been turned off by the driver.

### – Cargo Light

Indicates that the rear cargo light is on.

### – Door Ajar

Indicates that one of the vehicles doors is open.

# WHAT TO DO IN EMERGENCIES

## **Electronic Speed Control Set**

Indicates that the Electronic Speed Control has been set.

## **Fuel Cap/Loose Gas Cap Message**

If a “gas cap” message appears, tighten the gas cap until a “clicking” sound is heard.

Push the odometer reset button to turn the message off.

If the message continues to appear for more than three days after tightening the gas cap, see your authorized service center.

## **IF YOUR ENGINE OVERHEATS**

In any of the following situations, you can reduce the potential for overheating by taking the appropriate action.

- On the highways — slow down.
- In city traffic — while stopped, place the transmission in NEUTRAL, but do not increase the engine idle speed while preventing vehicle motion with the brakes.

### **NOTE:**

There are steps that you can take to slow down an impending overheat condition:

- If your air conditioner (A/C) is on, turn it off. The A/C system adds heat to the engine cooling system and turning the A/C off can help remove this heat.
- You can also turn the temperature control to maximum heat, the mode control to floor and the blower control to high. This allows the heater core to act as a supplement to the radiator and aids in removing heat from the engine cooling system.

### **CAUTION!**

Driving with a hot cooling system could damage your vehicle. If the temperature gauge reads HOT (H), pull over and stop the vehicle. Idle the vehicle with the air conditioner turned off until the pointer drops back into the normal range. If the pointer remains on HOT (H), and you hear continuous chimes, turn the engine off immediately and call for service.

### **WARNING!**

You or others can be badly burned by hot engine coolant (antifreeze) or steam from your radiator. If you see or hear steam coming from under the hood, do not open the hood until the radiator has had time to cool. Never try to open a cooling system pressure cap when the radiator or coolant bottle is hot.

# WHAT TO DO IN EMERGENCIES

## JACKING AND TIRE CHANGING

### Jack Location

The jack and jack tools are stored under the front passenger seat.

### Removal Of Jack And Tools

- To access the jack and jack tools you must remove the plastic access cover, located on the side of the seat. To remove the cover, pull the front part of the cover (closest to the front of the seat) toward you to release a locking tab. Once the front of the cover is loose, slide the cover toward the front of the seat until it is free from the seat frame.



Jack And Tools Location

### 1500 Series Trucks

- Remove the jack and tool bag by removing the wing bolt and sliding the jack and tool bag from under the seat.



Wing Bolt Location

# WHAT TO DO IN EMERGENCIES

## 2500/3500 Series Trucks

- Remove the jack and tool bracket assembly by removing the wing bolt and sliding the jack and tool bracket assembly from under the seat.



Jack And Tool Bracket Assembly

## Removing The Spare Tire

- Remove the spare tire before attempting to jack up the truck. Attach the wheel wrench to the jack extension tube. Insert the tube through the access hole between the lower tailgate and the top of the bumper and into the winch mechanism tube. Rotate the wheel wrench handle counterclockwise until the spare tire is on the ground with enough cable slack to allow you to pull it out from under the vehicle. When the spare is clear, tilt the retainer at the end of the cable and pull it through the center of the wheel.

### NOTE:

Always stow the spare tire with the valve stem facing the ground.

- It is recommended that you stow the flat or spare to avoid tangling the loose cable.

### NOTE:

The winch mechanism is designed for use with the jack extension tube only. Use of an air wrench or other power tools is not recommended and can damage the winch.

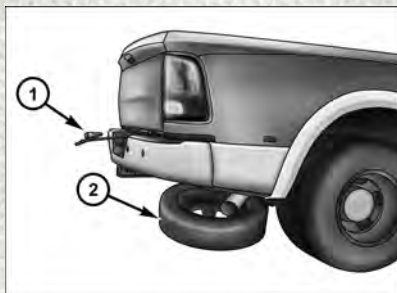

Wheel Wrench/Spare Tire

1 — Wheel  
Wrench

2 — Spare Tire

# WHAT TO DO IN EMERGENCIES

## Preparations

1. Park the vehicle on a firm, level surface. Avoid ice or slippery areas.
  2. Turn on the Hazard Warning flasher.
  3. Set the parking brake.
  4. Place the shift lever into PARK. On four-wheel drive vehicles, shift the transfer case to the 4L position.
  5. Turn the ignition OFF.
- Block both the front and rear of the wheel diagonally opposite the jacking position. For example, if the right front wheel is being changed, block the left rear wheel.

### NOTE:

Passengers should not remain in the vehicle when the vehicle is being jacked.



Wheel Blocked

## Instructions

1. Remove the spare wheel, jack, and tools from storage.
2. Using the wheel wrench, loosen, but do not remove, the wheel nuts by turning them counterclockwise one turn while the wheel is still on the ground.



Warning Label

# WHAT TO DO IN EMERGENCIES

## 3. Placement of the jack:

### 1500 Series Trucks

- When changing a front wheel, place the scissors jack under the rear portion of the lower control arm as shown below.



Front 4x2 Jacking Location



Front 4x4 Jacking Location

# WHAT TO DO IN EMERGENCIES

- Operate the jack using the jack drive tube and the wheel wrench. The tube extension may be used but is not required.
- **For 4x2 and 4x4 trucks**, when changing a rear wheel, assemble the jack drive tube to the jack and connect the drive tube to the extension tube. Place the jack under the axle between the wheel and the shock bracket with the drive tubes extending to the rear.



Rear 4x4 Jacking Location

- Connect the jack tube extension and wheel wrench.

# WHAT TO DO IN EMERGENCIES

## 2500/3500 Series Trucks

- For 2500/3500 4x2 series trucks, when changing a front wheel, place the bottle jack under the frame rail behind the wheel. Locate the jack as far forward as possible on the straight part of the frame.



### Jacking Location

- Operate the jack using the jack drive tube and the wheel wrench. The tube extension, may be used, but is not required.



# WHAT TO DO IN EMERGENCIES

- **For 2500/3500 4x4 series trucks**, when changing the front wheel, assemble the jack drive tube to the jack and connect the drive tube to the extension tube. Place the jack under the axle as close to the tire as possible with the drive tubes extending to the front. Connect the jack tube extension and wheel wrench.
- **For 4x2 and 4x4 trucks**, when changing a rear wheel, assemble the jack drive tube to the jack and connect the drive tube to the extension tube. Place the jack under the axle between the spring and the shock absorber with the drive tubes extending to the rear.
- Connect the jack tube extension and wheel wrench.

## NOTE:

If the bottle jack will not lower by turning the dial (thumbwheel) by hand, it may be necessary to use the jack drive tube in order to lower the jack.

- By rotating the wheel wrench clockwise, raise the vehicle until the wheel just clears the surface.
- Remove the wheel nuts and pull the wheel off. On single rear-wheel (SRW) trucks, install the spare wheel and wheel nuts with the cone shaped end of the wheel nuts toward the wheel. On 3500 dual rear-wheel models (DRW) the wheel nuts are a two-piece assembly with a flat face. Lightly tighten the wheel nuts. To avoid the risk of forcing the vehicle off the jack, do not fully tighten the wheel nuts until the vehicle has been lowered.
- Using the lug wrench, finish tightening the wheel nuts using a crisscross pattern. The correct wheel nut tightness is 130 ft lbs (176 N·m) torque (1500 Series), 135 ft lbs (183 N·m) torque for 2500/3500 single-rear wheel (SRW) models, and 140 ft lbs (190 N·m) for 3500 dual rear-wheel models. If in doubt about the correct tightness, have them checked with a torque wrench by your authorized dealer or at a service station.
- Install the wheel center cap and remove the wheel blocks. Do not install chrome or aluminum wheel center caps on the spare wheel. This may result in cap damage.



**Front Jacking Location**



**Rear Jacking Location**

# WHAT TO DO IN EMERGENCIES

- Lower the jack to its fully closed position. If the bottle jack will not lower by turning the dial (thumbwheel) by hand, it may be necessary to use the jack drive tube in order to lower the jack. Stow the replaced tire, jack, and tools as previously described.
- Adjust the tire pressure when possible.

## **NOTE:**

Do not oil wheel studs. For chrome wheels, do not substitute with chrome plated wheel nuts.

## **Reinstalling The Jack And Tools**

### **1500 Series Trucks**

1. Tighten the jack all the way down by turning the jack turn-screw clockwise until the jack is snug.
2. Position the jack and tool bag. Make sure the lug wrench is under the jack near the jack turn-screw.
3. Secure the tool bag straps to the jack.



**Jack And Tool Bag**

# WHAT TO DO IN EMERGENCIES

4. Place the jack and tools in the storage position holding the jack by the jack turn-screw, slip the jack and tools under the seat so that the bottom slot engages into the fastener on the floor.

**NOTE:**

Ensure that the jack slides into the front hold down location.



**Floor Fastener Location**

5. Turn the wing bolt clockwise to secure to the floor pan. Reinstall the plastic cover.



**Wing Bolt Location**

# WHAT TO DO IN EMERGENCIES

## 2500/3500 Series Trucks

1. Tighten the jack all the way down by turning the jack turn-screw clockwise until the jack is snug.
2. Position the jack and tools into bracket assembly. Make sure the lug wrench is under the jack near the jack turn-screw. Snap tools into bracket assembly clips. Install the jack into bracket assembly and turn screw until jack is snug into bracket assembly.
3. Place the jack and tool bracket assembly in the storage position holding the jack by the jack turn-screw, slip the jack and tools under the seat so that the bottom slot engages into the fastener on the floor.

### NOTE:

Ensure that the jack and tool bracket assembly slides into the front hold down location.

4. Turn the wing bolt clockwise to secure to the floor pan. Reinstall the plastic cover.



Floor Fastener Location

## Hub Caps/Wheel Covers

- The hub caps must be removed before raising the vehicle off the ground.
- For single rear-wheel (SRW) models, use the blade on the end of the lug wrench to pry the hub cap off. Insert the blade end into the pry-off notch and carefully pop off the hub cap with a back-and-forth motion.
- On models with dual rear wheels (DRW), you must first remove the hub caps. The jack handle driver has a hook at one end that will fit in the pry off notch of the rear hub caps. Position the hook and pull out on the ratchet firmly. The hub cap should pop off. The wheel skins can now be removed. For the front hub cap use the blade on the end of the lug wrench to pry the caps off. The wheel skin can now be removed.
- You must use the flat end of the lug wrench to pry off the wheel skins. Insert the flat tip completely and using a back-and-forth motion, loosen the wheel skin. Repeat this procedure around the tire until the skin pops off.
- Replace the wheel skins first using a rubber mallet. When replacing the hub caps, tilt the cap retainer over the lug nut bolt circle and strike the high side down with a rubber mallet. Be sure that the hub caps and wheel skins are firmly seated around the wheel.

# WHAT TO DO IN EMERGENCIES

## Wheel Nuts

All wheel nuts should be tightened occasionally to eliminate the possibility of wheel studs being sheared or the bolt holes in the wheels becoming elongated. This is especially important during the first few hundred miles/kilometers of operation to allow the wheel nuts to become properly set. All wheel nuts should first be firmly seated against the wheel. The wheel nuts should then be tightened to recommended torque. Tighten the wheel nuts to final torque in increments. Progress around the bolt circle, tightening the wheel nut opposite to the wheel nut just previously tightened until final torque is achieved.

Recommended torques are shown in the following chart:

### Disc Wheels

Nut Type	Stud Size	Hex Size	Torque Ft Lbs	Torque Newton Meters
Cone	M14 x 1.5	22 mm	130	176
Flanged	M14 x 1.5	22 mm	140	190

## 8-Stud — Dual Rear Wheels

- Dual wheels are flat-mounted and center-piloted. The lug nuts are a two-piece assembly. When the tires are being rotated or replaced, clean these lug nuts and add two drops of oil at the interface between the hex and the washer.
- Slots in the wheels will assist in properly orienting the inner and outer wheels. Align these slots when assembling the wheels for best access to the tire valve on the inner wheel. The tires of both dual wheels must be completely off the ground when tightening, to ensure wheel centering and maximum wheel clamping.
- Dual wheel models require a special heavy-duty lug nut tightening adapter (included with the vehicle) to correctly tighten the lug nuts. Also, when it is necessary to remove and install dual rear wheels, use a proper vehicle lifting device.

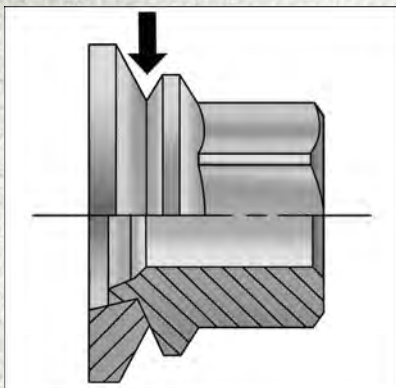

Oil Interface Location

### NOTE:

When installing a spare tire as part of a dual rear wheel end combination, the tire diameter of the two individual tires must be compared. If there is a significant difference, the larger tire should be installed in a front location. The correct direction of rotation for dual tire installations must also be observed.

# WHAT TO DO IN EMERGENCIES

These dual rear wheels should be tightened as follows:

1. Tighten the wheel nuts in the numbered sequence to a snug fit.
  2. Retighten the wheel nuts in the same sequence to the torques listed in the table. Go through the sequence a second time to verify that specific torque has been achieved. Retighten to specifications at 100 miles (160 km) and after 500 miles (800 km).
- It is recommended that wheel stud nuts be kept torqued to specifications at all times. Torque wheel stud nuts to specifications at each lubrication interval.

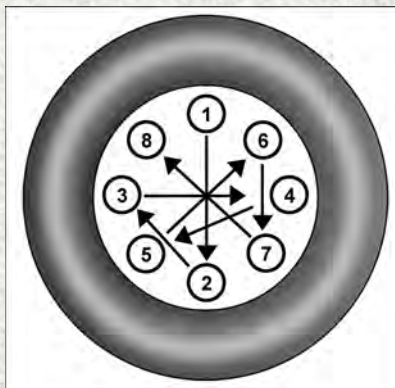

Wheel Nuts Numbered Sequence

## To Stow The Flat Or Spare

### NOTE:

RAM 1500 vehicles equipped with aluminum wheels cannot be stored under the vehicle because the wheel retainer will not fit through the wheel pilot hole. Secure the flat tire in the bed of the truck. Have the flat tire repaired or replaced immediately.

- Turn the wheel so that the valve stem is down. Slide the wheel retainer through the center of the wheel and position it properly across the wheel opening.
- For convenience in checking the spare tire inflation, stow with the valve stem toward the rear of the vehicle.
- Attach the wheel wrench to the extension tube. Rotate the winch mechanism until the wheel is drawn into place against the underside of the vehicle. Continue to rotate until you feel the winch mechanism slip, or click three or four times. It cannot be overtightened. Push against the tire several times to be sure it is firmly in place.

### CAUTION!

- Do not attempt to raise the vehicle by jacking on locations other than those indicated in the Jacking Instructions for this vehicle.
- Before raising the wheel off the ground, make sure that the jack will not damage surrounding truck parts and adjust the jack position as required.
- Use a back and forth motion to remove the hub cap. Do not use a twisting motion when removing the hub cap, damage to the hub cap; finish may occur.
- The rear hub caps on the dual rear wheel has two pry off notches. Make sure that the hook of the jack handle driver is located squarely in the cap notch before attempting to pull off.

# WHAT TO DO IN EMERGENCIES

## WARNING!

- Do not attempt to change a tire on the side of the vehicle close to moving traffic. Pull far enough off the road to avoid the danger of being hit when operating the jack or changing the wheel.
- Being under a jacked-up vehicle is dangerous. The vehicle could slip off the jack and fall on you. You could be crushed. Never put any part of your body under a vehicle that is on a jack.
- Never start or run the engine while the vehicle is on a jack. If you need to get under a raised vehicle, take it to an authorized dealer where it can be raised on a lift.
- The jack is designed to be used as a tool for changing tires only. The jack should not be used to lift the vehicle for service purposes. The vehicle should be jacked on a firm level surface only. Avoid ice or slippery areas.
- Do not attempt to change a tire on the side of the vehicle close to moving traffic, pull far enough off the road to avoid the danger of being hit when operating the jack or changing the wheel.
- Carefully follow these tire changing warnings to help prevent personal injury or damage to your vehicle:
  - Always park on a firm, level surface as far from the edge of the roadway as possible before raising the vehicle.
  - Turn on the Hazard Warning flashers.
  - Block the wheel diagonally opposite the wheel to be raised.
  - Set the parking brake firmly and set an automatic transmission in PARK; a manual transmission in REVERSE.
  - Do not let anyone sit in the vehicle when it is on a jack.
  - Do not get under the vehicle when it is on a jack.
  - Only use the jack in the positions indicated and for lifting this vehicle during a tire change.
  - If working on or near a roadway, be extremely careful of motor traffic.
  - To assure that spare tires, flat or inflated, are securely stowed, spares must be stowed with the valve stem facing the ground.
  - Raising the vehicle higher than necessary can make the vehicle less stable. It could slip off the jack and hurt someone near it. Raise the vehicle only enough to remove the tire.
  - To avoid the risk of forcing the vehicle off the jack, do not fully tighten the wheel bolts until the vehicle has been lowered. Failure to follow this warning may result in personal injury.
  - To avoid possible personal injury, handle the wheel covers with care to avoid contact with any sharp edges.
  - A loose tire or jack thrown forward in a collision or hard stop could endanger the occupants of the vehicle. Always stow the jack parts and the spare tire in the places provided.
  - A loose tire thrown forward in a collision or hard stop could injure the occupants in the vehicle. Have the deflated (flat) tire repaired or replaced immediately.

# WHAT TO DO IN EMERGENCIES

## JUMP-STARTING PROCEDURES

If your vehicle has a discharged battery it can be jump-started using a set of jumper cables and a battery in another vehicle or by using a portable battery booster pack. Jump-starting can be dangerous if done improperly so please follow the procedures in this section carefully.

### **NOTE:**

When using a portable battery booster pack follow the manufacturer's operating instructions and precautions.

### **CAUTION!**

Do not use a portable battery booster pack or any other booster source with a system voltage greater than 12 Volts or damage to the battery, starter motor, alternator or electrical system may occur.

### **WARNING!**

Do not attempt jump-starting if the battery is frozen. It could rupture or explode and cause personal injury.



# WHAT TO DO IN EMERGENCIES

## Preparations For Jump-Start

The battery in your vehicle is located in the front of the engine compartment, behind the left headlight assembly.

### NOTE:

The positive battery post is covered with a protective cap. Lift up on the cap to gain access to the positive battery post. Do not jump off fuses. Only jump directly off positive post.

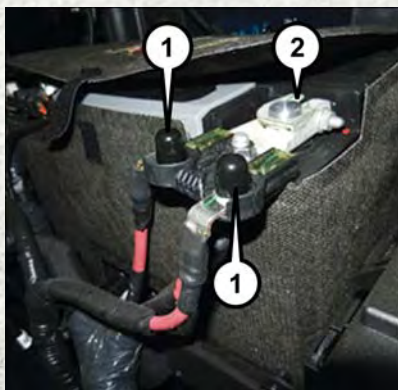

**Battery Positive Post (Gas Version Shown)**

- 1 — Fuses
- 2 — Positive Battery Post

### WARNING!

- Take care to avoid the radiator cooling fan whenever the hood is raised. It can start anytime the ignition switch is ON. You can be injured by moving fan blades.
- Remove any metal jewelry such as rings, watch bands and bracelets that could make an inadvertent electrical contact. You could be seriously injured.
- Batteries contain sulfuric acid that can burn your skin or eyes and generate hydrogen gas which is flammable and explosive. Keep open flames or sparks away from the battery.

1. Set the parking brake, shift the automatic transmission into PARK and turn the ignition to LOCK.
2. Turn off the heater, radio, and all unnecessary electrical accessories.
3. If using another vehicle to jump-start the battery, park the vehicle within the jumper cables reach, set the parking brake and make sure the ignition is OFF.

# WHAT TO DO IN EMERGENCIES

## WARNING!

Do not allow vehicles to touch each other as this could establish a ground connection and personal injury could result.

## Jump-Starting Procedure

## WARNING!

Failure to follow this jump-starting procedure could result in personal injury or property damage due to battery explosion.

## CAUTION!

Failure to follow these procedures could result in damage to the charging system of the booster vehicle or the discharged vehicle.

## Connecting The Jumper Cables

1. Connect the positive (+) end of the jumper cable to the positive (+) post of the discharged vehicle.

### NOTE:

**Do not jump off fuses. Only jump directly off positive post.**

2. Connect the opposite end of the positive (+) jumper cable to the positive (+) post of the booster battery.
3. Connect the negative (-) end of the jumper cable to the negative (-) post of the booster battery.
4. Connect the opposite end of the negative (-) jumper cable to a good engine ground (exposed metal part of the discharged vehicle's engine) away from the battery and the fuel injection system.

## WARNING!

Do not connect the jumper cable to the negative (-) post of the discharged battery. The resulting electrical spark could cause the battery to explode and could result in personal injury. Only use the specific ground point, do not use any other exposed metal parts.

5. Start the engine in the vehicle that has the booster battery, let the engine idle a few minutes, and then start the engine in the vehicle with the discharged battery.

## CAUTION!

Do not connect jumper cable to any of the fuses on the positive battery terminal. The resulting electrical current will blow the fuse.

# WHAT TO DO IN EMERGENCIES

6. Once the engine is started, remove the jumper cables in the reverse sequence:

## Disconnecting The Jumper Cables

1. Disconnect the negative (-) end of the jumper cable from the engine ground of the vehicle with the discharged battery.
2. Disconnect the opposite end of the negative (-) jumper cable from the negative (-) post of the booster battery.
3. Disconnect the positive (+) end of the jumper cable from the positive (+) post of the booster battery.
4. Disconnect the opposite end of the positive (+) jumper cable from the positive (+) post of the vehicle with the discharged battery.

If frequent jump-starting is required to start your vehicle you should have the battery and charging system inspected at your authorized dealer.

### CAUTION!

Accessories plugged into the vehicle power outlets draw power from the vehicle's battery, even when not in use (i.e., cellular devices, etc.). Eventually, if plugged in long enough without engine operation, the vehicle's battery will discharge sufficiently to degrade battery life and/or prevent the engine from starting.

## EMERGENCY TOW HOOKS

Your vehicle may be equipped with emergency tow hooks.

### NOTE:

For off-road recovery, it is recommended to use both of the front tow hooks to minimize the risk of damage to the vehicle.

### WARNING!

- Do not use a chain for freeing a stuck vehicle. Chains may break, causing serious injury or death.
- Stand clear of vehicles when pulling with tow hooks. Tow straps may become disengaged, causing serious injury.

### CAUTION!

Tow hooks are for emergency use only to rescue a vehicle stranded off-road. Do not use tow hooks for tow truck hookup or highway towing. You could damage your vehicle.

# WHAT TO DO IN EMERGENCIES

## SHIFT LEVER OVERRIDE — 6-SPEED TRANSMISSION

If a malfunction occurs and the shift lever cannot be moved out of the PARK position, you can use one of the following procedures to temporarily move the shift lever:

### Column Shifter — If Equipped

1. Turn the engine off.
2. Firmly apply the parking brake.
3. Tilt the steering wheel to the full up position.
4. Push and maintain firm pressure on the brake pedal.
5. Insert a screwdriver or similar tool, into the access port (ringed circle) on the bottom of the steering column and push and hold the override release lever up.
6. Move the shift lever to the NEUTRAL position.
7. The vehicle may then be started in NEUTRAL.



Shift Lock Manual Override Access Port

# WHAT TO DO IN EMERGENCIES

## Center Console Shifter — If Equipped

1. Turn the engine off.
2. Firmly apply the parking brake.
3. Using a small screwdriver or similar tool, remove the shift lever override access cover (located to the right of the shift lever).
4. Push and maintain firm pressure on the brake pedal.
5. Insert the screwdriver or similar tool into the access hole, and push and hold the override release lever down.
6. Move the shift lever to the NEUTRAL position.
7. The vehicle may then be started in NEUTRAL.
8. Reinstall the shift lever override access cover.



Shift Lever Override Access Cover

# WHAT TO DO IN EMERGENCIES

## MANUAL PARK RELEASE — 8 SPEED TRANSMISSION

### WARNING!

Always secure your vehicle by fully applying the parking brake, before activating the Manual Park Release. Activating the Manual Park Release will allow your vehicle to roll away if it is not secured by the parking brake or by proper connection to a tow vehicle. Activating the Manual Park Release on an unsecured vehicle could lead to serious injury or death for those in or around the vehicle.

In order to push or tow the vehicle in cases where the transmission will not shift out of PARK (such as a dead battery), a Manual Park Release is available.

Follow these steps to activate the Manual Park Release:

1. Firmly apply the parking brake.
2. Using a small screwdriver or similar tool, remove the Manual Park Release access cover, which is just above the parking brake release handle, below and to the left of the steering column.



Manual Park Release Access Cover

# WHAT TO DO IN EMERGENCIES

- Using the screwdriver or similar tool, push the Manual Park Release lever locking tab (just below the middle of the lever) to the right.



**Manual Park Release Lever Locking Tab**

- While holding the locking tab in the disengaged position, pull the tether strap to rotate the lever rearward, until it locks in place pointing towards the driver's seat. Release the locking tab and verify that the Manual Park Release lever is locked in the released position.
- The vehicle is now out of PARK and can be towed. Release the parking brake only when the vehicle is securely connected to a tow vehicle.



**Manual Park Release Tether**

# WHAT TO DO IN EMERGENCIES

## To Reset The Manual Park Release:

1. Push the locking tab to the right, to unlock the lever.
2. Rotate the Manual Park Release lever forward to its original position, until the locking tab snaps into place to secure the lever.
3. Pull gently on the tether strap to confirm that the lever is locked in its stowed position.
4. Re-install the access cover.

## TOWING A DISABLED VEHICLE

Towing Condition	Wheels OFF the Ground	2WD Models	4WD Models
Flat Tow	NONE	If transmission is operable: <ul style="list-style-type: none"><li>• Transmission in <b>NEUTRAL</b></li><li>• 30 mph (48 km/h) <b>max</b></li><li>• 15 miles (24 km) <b>max</b> distance</li></ul>	<ul style="list-style-type: none"><li>• Auto Transmission in <b>PARK</b></li><li>• Manual Transmission in gear (<b>NOT NEUTRAL</b>)</li><li>• Transfer Case in <b>NEUTRAL</b></li><li>• Tow in <b>FORWARD</b> direction</li></ul>
Wheel Lift or Dolly Tow	Front	<b>OK</b>	<b>NOT ALLOWED</b>
	Rear		<b>NOT ALLOWED</b>
Flatbed	<b>ALL</b>	<b>BEST METHOD</b>	<b>BEST METHOD</b>

## FREEING A STUCK VEHICLE

If your vehicle becomes stuck in mud, sand, or snow, it can often be moved using a rocking motion. Turn the steering wheel right and left to clear the area around the front wheels. Then shift back and forth between DRIVE and REVERSE (with automatic transmission) or 2nd gear and REVERSE (with manual transmission), while gently pressing the accelerator. Use the least amount of accelerator pedal pressure that will maintain the rocking motion, without spinning the wheels or racing the engine.

### NOTE:

For trucks equipped with 8-speed automatic transmission: Shifts between DRIVE and REVERSE can only be achieved at wheel speeds of 5 mph (8 km/h) or less. Whenever the transmission remains in NEUTRAL for more than two seconds, you must push the brake pedal to engage DRIVE or REVERSE.



# WHAT TO DO IN EMERGENCIES

## CAUTION!

Racing the engine or spinning the wheels may lead to transmission overheating and failure. Allow the engine to idle with the transmission in NEUTRAL for at least one minute after every five rocking-motion cycles. This will minimize overheating and reduce the risk of clutch or transmission failure during prolonged efforts to free a stuck vehicle.

### NOTE:

Push the "ESC Off" switch, to place the Electronic Stability Control (ESC) system in "Partial Off" mode, before rocking the vehicle. Refer to "Electronic Brake Control" in "Starting And Operating" for further information. Once the vehicle has been freed, push the "ESC Off" switch again to restore "ESC On" mode.

## CAUTION!

- When "rocking" a stuck vehicle by shifting between DRIVE/2nd gear and REVERSE, do not spin the wheels faster than 15 mph (24 km/h), or drivetrain damage may result.
- Revving the engine or spinning the wheels too fast may lead to transmission overheating and failure. It can also damage the tires. Do not spin the wheels above 30 mph (48 km/h) while in gear (no transmission shifting occurring).

## WARNING!

Fast spinning tires can be dangerous. Forces generated by excessive wheel speeds may cause damage, or even failure, of the axle and tires. A tire could explode and injure someone. Do not spin your vehicle's wheels faster than 30 mph (48 km/h) or for longer than 30 seconds continuously without stopping when you are stuck and do not let anyone near a spinning wheel, no matter what the speed.

# WHAT TO DO IN EMERGENCIES

## **ENHANCED ACCIDENT RESPONSE SYSTEM (EARS)**

This vehicle is equipped with an Enhanced Accident Response System.

Please refer to “Supplemental Restraint System (SRS) — Air Bags” in “Getting Started” in this guide for further information on the Enhanced Accident Response System (EARS) function.

## **EVENT DATA RECORDER (EDR)**

This vehicle is equipped with an event data recorder (EDR). The main purpose of an EDR is to record, in certain crash or near crash-like situations, such as an air bag deployment or hitting a road obstacle, data that will assist in understanding how a vehicle's systems performed.

Please refer to “Supplemental Restraint System (SRS) — Air Bags” in “Getting Started” in this guide for further information on the Event Data Recorder (EDR).

# MAINTAINING YOUR VEHICLE

## TO OPEN AND CLOSE THE HOOD

To open the hood, two latches must be released.

1. Pull the hood release lever located below the steering wheel at the base of the instrument panel.
2. Reach into the opening beneath the center of the hood and push the safety latch lever to the left to release it, before raising the hood.



**Hood Release Lever Location**

### **CAUTION!**

To prevent possible damage, do not slam the hood to close it. Use a firm downward push at the front center of the hood to ensure that both latches engage.

### **WARNING!**

Be sure the hood is fully latched before driving your vehicle. If the hood is not fully latched, it could open when the vehicle is in motion and block your vision. Failure to follow this warning could result in serious injury or death.

# MAINTAINING YOUR VEHICLE

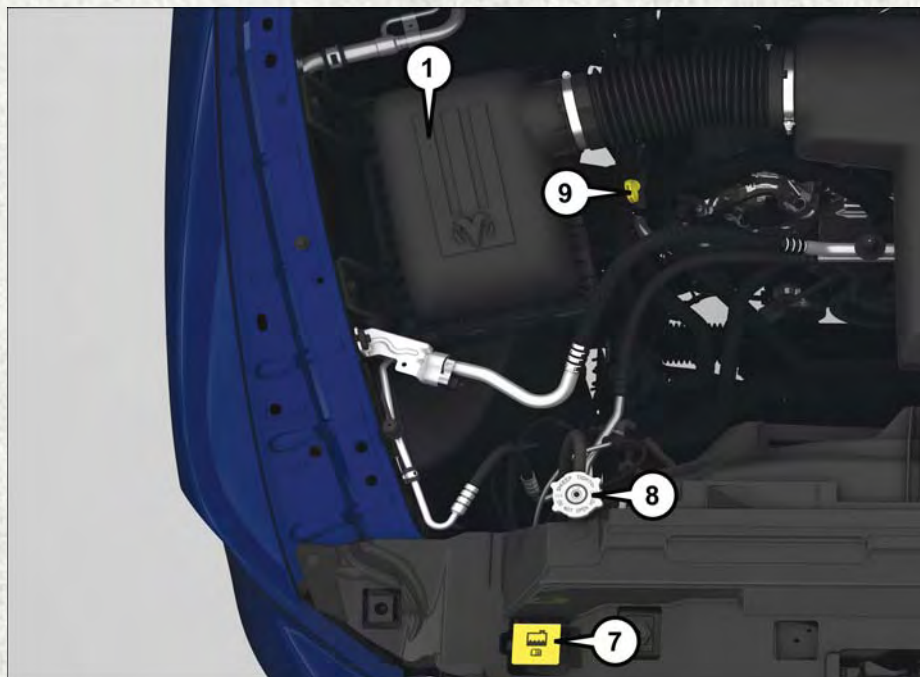

## ENGINE COMPARTMENT — 3.6L

1. Air Cleaner Filter
2. Engine Oil Fill (Under Cover)
3. Brake Fluid Reservoir
4. Battery
5. Power Distribution Center (Fuses)
6. Coolant Reservoir
7. Windshield Washer Fluid Reservoir
8. Alternator
9. Water Pump

# MAINTAINING YOUR VEHICLE

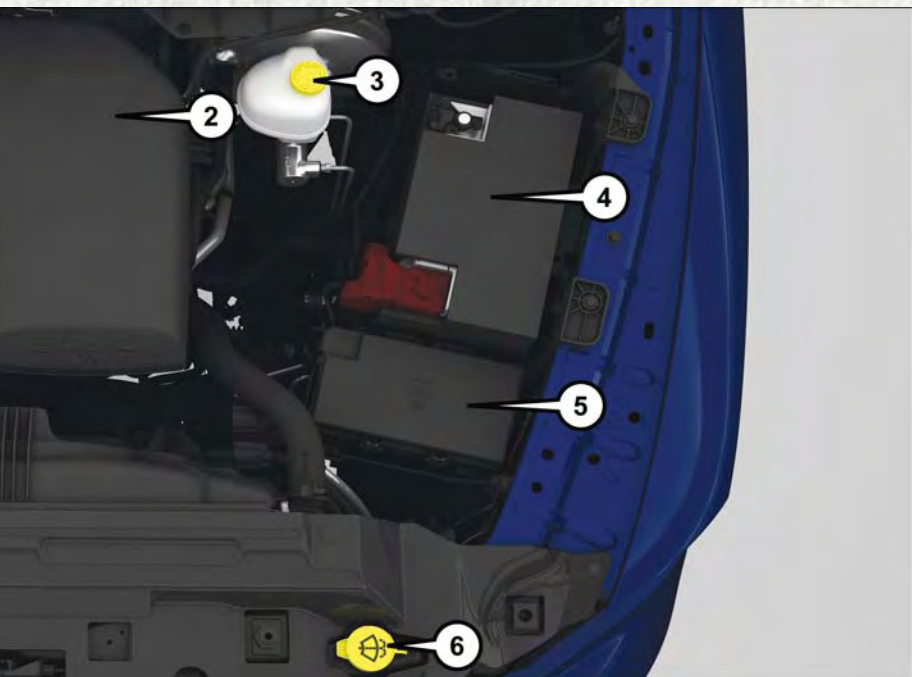

- 6. Washer Fluid Reservoir
- 7. Engine Coolant Reservoir
- 8. Engine Coolant Pressure Cap
- 9. Engine Oil Dipstick

# MAINTAINING YOUR VEHICLE

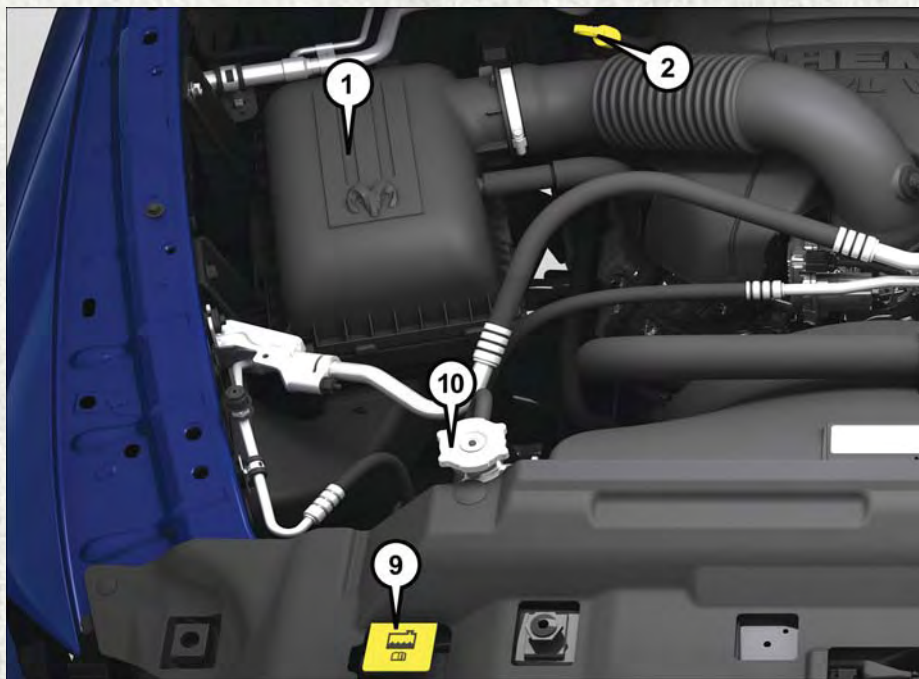

## ENGINE COMPARTMENT — 5.7L

1. Air Cleaner Filter
2. Transmission Fluid Dipstick
3. Engine Oil Fill
4. Brake Fluid Reservoir
5. Battery

# MAINTAINING YOUR VEHICLE

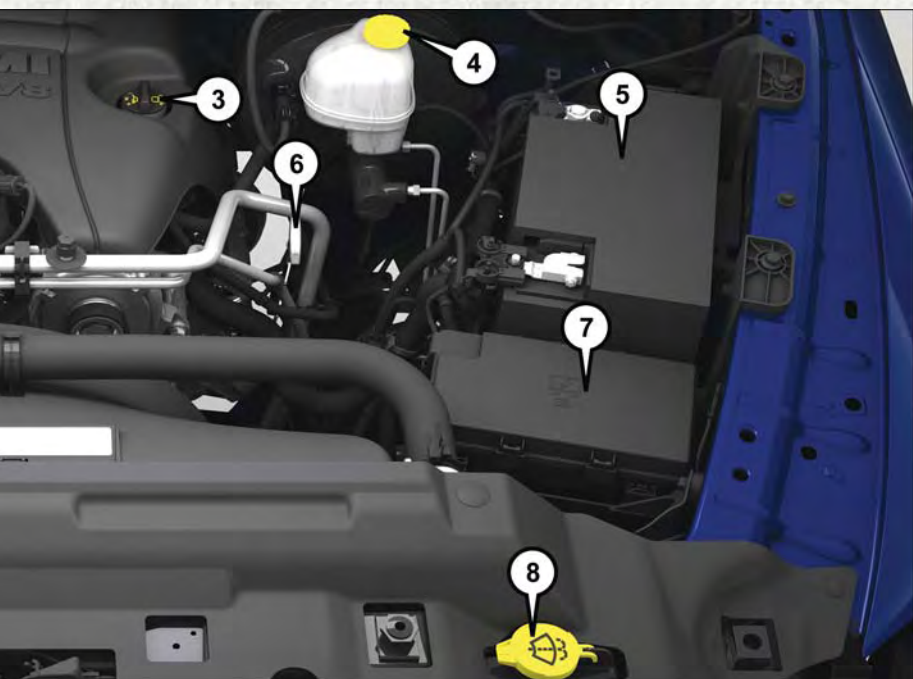

- 6. Engine Oil Dipstick
- 7. Power Distribution Center (Fuses)
- 8. Washer Fluid Reservoir
- 9. Engine Coolant Reservoir
- 10. Engine Coolant Pressure Cap

# MAINTAINING YOUR VEHICLE



## ENGINE COMPARTMENT — 6.4L

1. Engine Coolant Reservoir
2. Transmission Fluid Dipstick
3. Engine Oil Fill
4. Brake Fluid Reservoir
5. Aux Power Distribution Center (Fuses)
6. Battery



# MAINTAINING YOUR VEHICLE

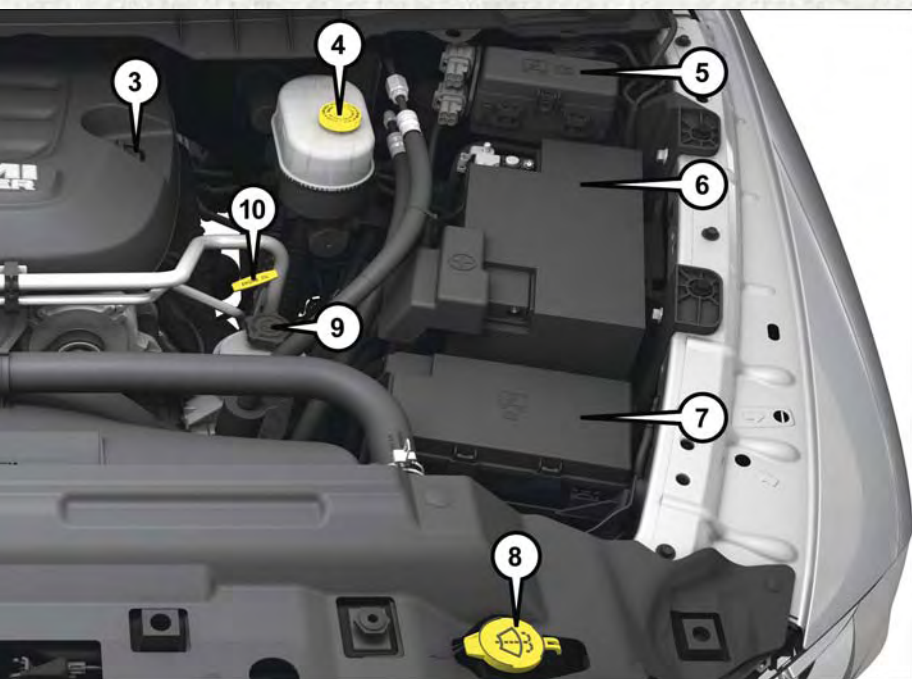

- 7. Power Distribution Center (Fuses)
- 8. Washer Fluid Reservoir
- 9. Power Steering Reservoir
- 10. Engine Oil Dipstick
- 11. Air Cleaner Filter

# MAINTAINING YOUR VEHICLE

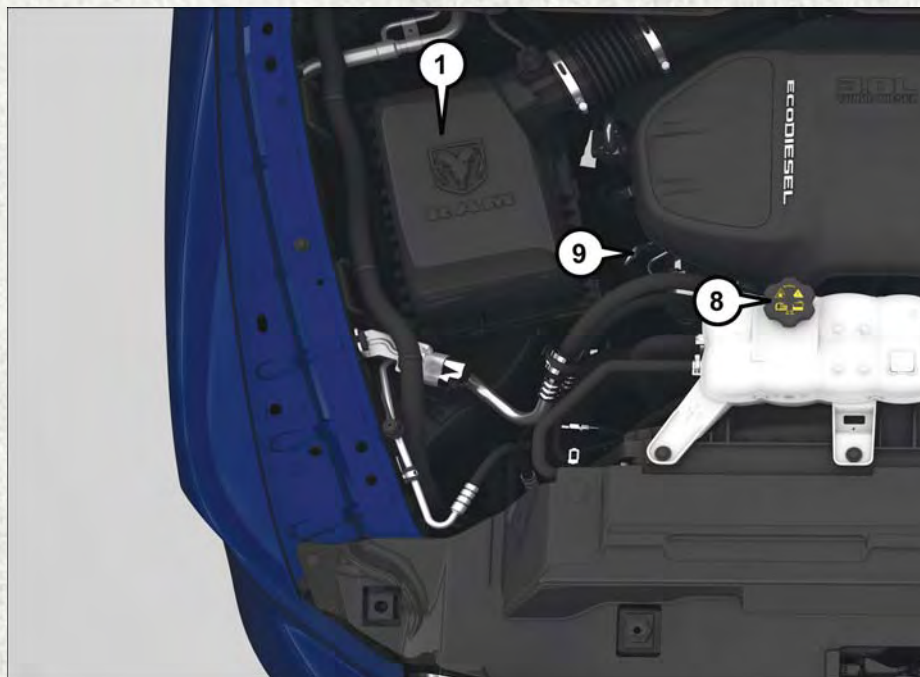

## ENGINE COMPARTMENT — 3.0L DIESEL

1. Air Cleaner Filter
2. Engine Oil Fill
3. Brake Fluid Reservoir
4. Aux Power Distribution Center (Fuses)
5. Battery

# MAINTAINING YOUR VEHICLE

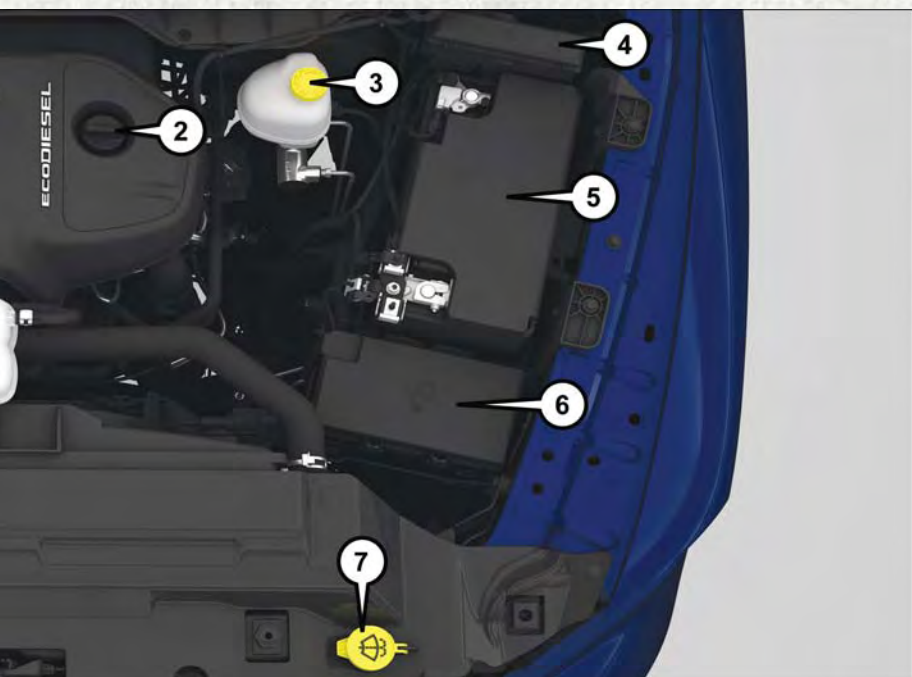

- 6. Power Distribution Center (Fuses)
- 7. Washer Fluid Reservoir
- 8. Engine Coolant Reservoir
- 9. Engine Oil Dipstick

# MAINTAINING YOUR VEHICLE



## ENGINE COMPARTMENT — 6.7L DIESEL WITH 68RFE TRANSMISSION

1. Batteries
2. Engine Coolant Reservoir
3. Transmission Fluid Dipstick
4. Brake Fluid Reservoir
5. Aux Power Distribution Center (Fuses)
6. Washer Fluid Reservoir

# MAINTAINING YOUR VEHICLE

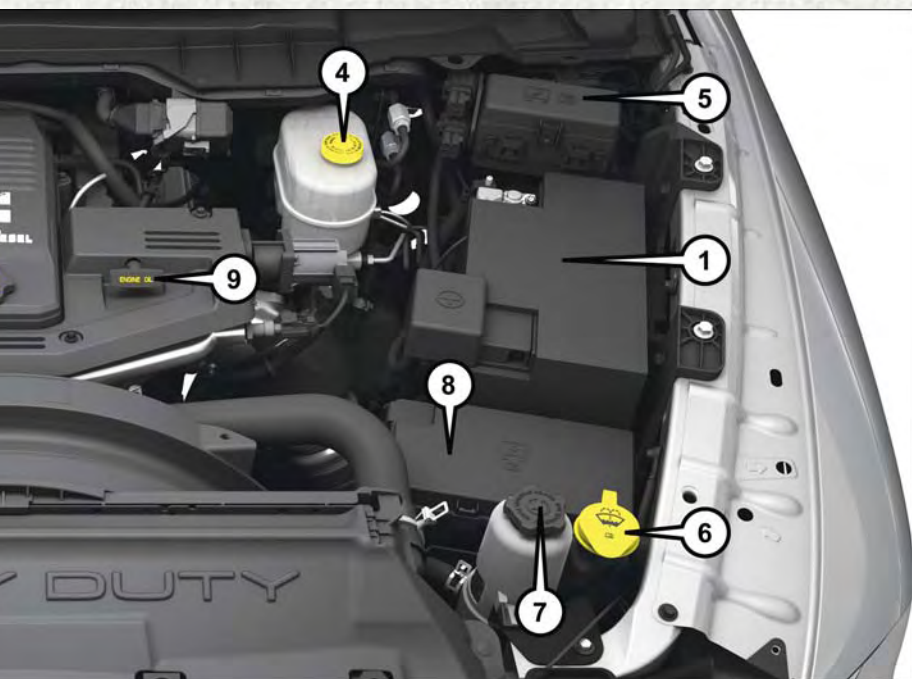

7. Power Steering Fluid Reservoir
8. Power Distribution Center (Fuses)
9. Engine Oil Dipstick
10. Engine Oil Fill
11. Air Cleaner Filter

# MAINTAINING YOUR VEHICLE



## ENGINE COMPARTMENT — 6.7L DIESEL WITH AS69RC TRANSMISSION

1. Batteries
2. Engine Coolant Reservoir
3. Transmission Fluid Dipstick
4. Brake Fluid Reservoir
5. Aux Power Distribution Center (Fuses)
6. Power Distribution Center (Fuses)

# MAINTAINING YOUR VEHICLE

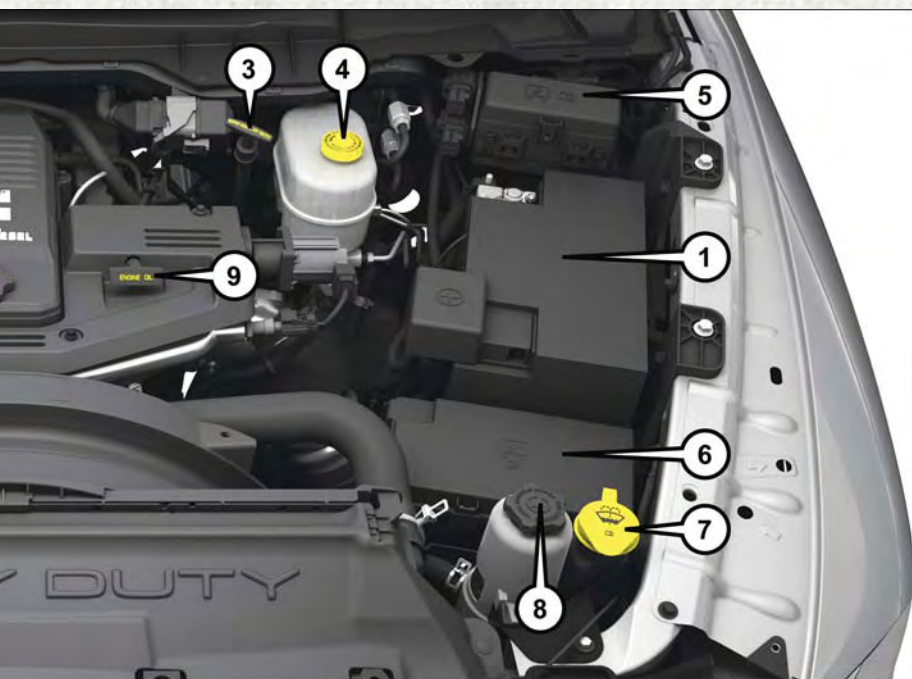

- 7. Washer Fluid Reservoir
- 8. Power Steering Fluid Reservoir
- 9. Engine Oil Dipstick
- 10. Engine Oil Fill
- 11. Air Cleaner Filter

# MAINTAINING YOUR VEHICLE

## FLUID CAPACITIES — GAS ENGINE

	U.S.	Metric
<b>Fuel (Approximate)</b>		
1500 Regular Cab Shortbed/Crew Quad Cab Models	26 Gallons	98 Liters
1500 Regular Cab Longbed/Crew Quad Cab Models (Optional)	32 Gallons	121 Liters
2500/3500 Shortbed Models	31 Gallons	117 Liters
2500/3500 Longbed Models	32 Gallons	121 Liters
<b>Engine Oil With Filter</b>		
3.6L Engine (We recommend you use SAE 5W-20, API Certified)	6 Quarts	5.6 Liters
5.7L Engines (We recommend you use SAE 5W-20, API Certified)	7 Quarts	6.6 Liters
5.7L Engine (We recommend you use SAE 5W-30, API Certified), for 2500/3500 trucks operating under a gross combined weight rating greater than 14,000 lbs (6 350 kg).	7 Quarts	6.6 Liters
6.4L Engines (We recommend you use SAE 0W-40 engine oil meeting the requirements of FCA Material Standard MS-12633 for use in all operating temperatures.)	7 Quarts	6.6 Liters
<b>Cooling System</b>		
3.6L Engine (We recommend you use MOPAR Antifreeze/Coolant 10 Year/150,000 Mile Formula that meets the requirements of FCA Material Standard MS.90032.)	13.7 Quarts	13 Liters
5.7L Engine – 1500 Models (We recommend you use MOPAR Antifreeze/Coolant 10 Year/150,000 Mile Formula that meets the requirements of FCA Material Standard MS.90032.)	18.3 Quarts	17.3 Liters
5.7L Engine – 2500/3500 Models (We recommend you use MOPAR Antifreeze/Coolant 10 Year/150,000 Mile Formula that meets the requirements of FCA Material Standard MS.90032.)	18.3 Quarts	17.3 Liters
6.4 Liter Engine – 2500/3500 Models (We recommend you use MOPAR Antifreeze/Coolant 10 Year/150,000 Mile Formula that meets the requirements of FCA Material Standard MS.90032.)	16.6 Quarts	15.7 Liters



# MAINTAINING YOUR VEHICLE

## FLUIDS, LUBRICANTS, AND GENUINE PARTS — GAS ENGINE

### Engine

Component	Fluid, Lubricant, or Genuine Part
Engine Coolant	We recommend you use MOPAR Antifreeze/Coolant 10 Year/150,000 Mile Formula OAT (Organic Additive Technology).
Engine Oil – 3.6L Engine	We recommend you use API Certified SAE 5W-20 Engine Oil, meeting the requirements of FCA Material Standard MS-6395 such as MOPAR, Pennzoil, and Shell Helix. Refer to your engine oil filler cap for correct SAE grade. MOPAR SAE 5W-30 engine oil approved to FCA Material Standard MS-6395 may be used when SAE 5W-20 engine oil meeting MS-6395 is not available.
Engine Oil – 5.7L Engine	We recommend you use API Certified SAE 5W-20 Engine Oil, meeting the requirements of FCA Material Standard MS-6395 such as MOPAR, Pennzoil, and Shell Helix. Refer to your engine oil filler cap for correct SAE grade.
Engine Oil – 5.7L Engine 2500/3500 trucks operating under a gross combined weight rating <b>greater</b> than 14,000 lbs/(6,350 kg.)	We recommend you use API Certified SAE 5W-30 Engine Oil, meeting the requirements of FCA Material Standard MS-6395 such as MOPAR, Pennzoil, Shell Helix or equivalent. Refer to your engine oil filler cap for correct SAE grade.
Engine Oil – 6.4L	For best performance and maximum protection under all types of operating conditions, the manufacturer only recommends full synthetic engine oils that meet the American Petroleum Institute (API) categories of SN. The manufacturer recommends the use of Pennzoil Ultra 0W-40 or equivalent MOPAR engine oil meeting the requirements of FCA Material Standard MS-12633 for use in all operating temperatures.
Engine Oil Filter	We recommend you use MOPAR brand Engine Oil Filters.
Spark Plugs	We recommend you use MOPAR Spark Plugs.
Fuel Selection – 3.6L Engine	87 Octane, 0-15% Ethanol.
Fuel Selection – 3.6L Flex Fuel (E-85) Engine – If Equipped	87 Octane, Up To 85% Ethanol.
Fuel Selection – 5.7L/6.4L Engines	89 Octane Recommended - 87 Octane Acceptable, 0-15% Ethanol.

# MAINTAINING YOUR VEHICLE

## CAUTION!

- Mixing of engine coolant (antifreeze) other than specified Organic Additive Technology (OAT) engine coolant (antifreeze), may result in engine damage and may decrease corrosion protection. Organic Additive Technology (OAT) engine coolant is different and should not be mixed with Hybrid Organic Additive Technology (HOAT) engine coolant (antifreeze) or any “globally compatible” coolant (antifreeze). If a non-OAT engine coolant (antifreeze) is introduced into the cooling system in an emergency, the cooling system will need to be drained, flushed, and refilled with fresh OAT coolant (conforming to MS.90032), by an authorized dealer as soon as possible.
- Do not use water alone or alcohol-based engine coolant (antifreeze) products. Do not use additional rust inhibitors or antirust products, as they may not be compatible with the radiator engine coolant and may plug the radiator.
- This vehicle has not been designed for use with propylene glycol-based engine coolant (antifreeze). Use of propylene glycol-based engine coolant (antifreeze) is not recommended.

## E-85 Flexible Fuel — 3.6L Engine Only

### E-85 General Information

The information in this section is unique for Flexible Fuel vehicles only. These vehicles can be identified by a unique fuel filler door label that states **Ethanol (E-85) or Unleaded Gasoline Only** and a yellow fuel cap. Refer to the Owner's Manual on the DVD for further information.

## CAUTION!

Only vehicles with the E-85 fuel filler door label or a yellow gas cap can operate on E-85.

## Chassis

Component	Fluid, Lubricant, or Genuine Part
Automatic Transmission – Eight-Speed Automatic	Use only MOPAR ZF 8&9 Speed ATF Automatic Transmission Fluid, or equivalent. Failure to use the correct fluid may affect the function or performance of your transmission.
Automatic Transmission – Six-Speed Automatic with Gasoline Engine (For Diesel Engine see Diesel Supplement)	Use only ATF+4 Automatic Transmission Fluid. Failure to use ATF+4 fluid may affect the function or performance of your transmission. We recommend MOPAR ATF+4 fluid.
Transfer Case	We recommend you use MOPAR BW44–44 Transfer Case Fluid.

# MAINTAINING YOUR VEHICLE

Component	Fluid, Lubricant, or Genuine Part
Front Axle – 1500 Four-Wheel Drive Models	We recommend you use MOPAR GL-5 Synthetic Axle Lubricant SAE 75W-85.
Rear Axle – 1500 Models	We recommend you use MOPAR Synthetic Gear Lubricant SAE 75W-140 (MS-8985). Limited-Slip Rear Axles require the addition of 5 oz. (148 ml) MOPAR Limited Slip Additive (MS-10111).
Front and Rear Axle – 2500/3500 Models	We recommend you use Synthetic, GL-5 SAE, 75W-90. Limited slip additive is not required for Limited-Slip Rear Axles.
Brake Master Cylinder	We recommend you use MOPAR DOT 3. If DOT 3 brake fluid is not available, then DOT 4 is acceptable.
Power Steering Reservoir – 2500/3500 Models	We recommend you use MOPAR Power Steering Fluid +4 or MOPAR ATF+4 Automatic Transmission Fluid.

## FLUID CAPACITIES — 1500 3.0L DIESEL

	U.S.	Metric
<b>Fuel (Approximate)</b>		
3.0L Diesel Engine	26 Gallons	98.5 Liters
Diesel Exhaust Fluid Tank	8 Gallons	30.3 Liters
<b>Engine Oil With Filter</b>		
3.0L Liter Diesel Engine (SAE 5W-30 Synthetic, API Certified Low Ash)	10.5 Quarts	10 Liters
<b>Cooling System</b>		
3.0L Turbo Diesel Engine (MOPAR Engine Coolant/Antifreeze 10 Year/150,000 Mile Formula OAT (Organic Additive Technology))	11.6 Quarts	11 Liters

## FLUIDS, LUBRICANTS, AND GENUINE PARTS — 1500 3.0L DIESEL

### Engine

Component	Fluid, Lubricant, or Genuine Part
Engine Coolant	We recommend you use MOPAR Antifreeze/Coolant 10 Year/150,000 Mile Formula OAT (Organic Additive Technology).
Engine Oil	Only use ACEA C3 5W-30 Synthetic Low Ash engine oil meeting FCA Material Standard MS-11106 or Pennzoil Ultra Euro L full synthetic 5W-30 motor oil.
Engine Oil Filter	We recommend you use MOPAR Engine Oil Filters.
Fuel Filters	We recommend you use MOPAR Fuel Filter. Must meet 3 micron rating. <b>Using a fuel filter that does not meet the manufacturers filtration and water separating requirements can severely impact fuel system life and reliability.</b>

# MAINTAINING YOUR VEHICLE

Component	Fluid, Lubricant, or Genuine Part
Fuel Selection	<p>Use good quality diesel fuel from a reputable supplier in your vehicle. Federal law requires that you must fuel this vehicle with Ultra Low Sulfur Highway Diesel fuel (15 ppm Sulfur maximum) and prohibits the use of Low Sulfur Highway Diesel fuel (500 ppm Sulfur maximum) to avoid damage to the emissions control system.</p> <p>For most year-round service, No. 2 diesel fuel meeting ASTM specification D-975 Grade S15 will provide good performance. We recommend you use a blend of up to 5% biodiesel, meeting ASTM specification D-975 with your diesel engine. <b>This vehicle is compatible with biodiesel blends greater than 5% but no greater than 20% biodiesel meeting ASTM specification D-7467 provided the shortened maintenance intervals are followed as directed.</b></p>
Diesel Exhaust Fluid	<p>MOPAR Diesel Exhaust Fluid (API Certified) (DEF) or equivalent that has been API Certified to the ISO 22241 standard. Use of fluids not API Certified to ISO 22241 may result in system damage.</p>

## NOTE:

If the vehicle is exposed to extreme cold (below 20°F or -7°C), or is required to operate at colder-than-normal conditions for prolonged periods, use climatized No. 2 diesel fuel or dilute the No. 2 diesel fuel with 50% No. 1 diesel fuel. This will provide better protection from fuel gelling or wax-plugging of the fuel filter.

## CAUTION!

- Mixing of engine coolant (antifreeze) other than specified Organic Additive Technology (OAT) engine coolant (antifreeze), may result in engine damage and may decrease corrosion protection. Organic Additive Technology (OAT) engine coolant is different and should not be mixed with Hybrid Organic Additive Technology (HOAT) engine coolant (antifreeze) or any “globally compatible” coolant (antifreeze). If a non-OAT engine coolant (antifreeze) is introduced into the cooling system in an emergency, the cooling system will need to be drained, flushed, and refilled with fresh OAT coolant (conforming to MS.90032), by an authorized dealer as soon as possible.
- Do not use water alone or alcohol-based engine coolant (antifreeze) products. Do not use additional rust inhibitors or antirust products, as they may not be compatible with the radiator engine coolant and may plug the radiator.
- This vehicle has not been designed for use with propylene glycol-based engine coolant (antifreeze). Use of propylene glycol-based engine coolant (antifreeze) is not recommended.

# MAINTAINING YOUR VEHICLE

## Chassis

Component	Fluid, Lubricant, or Genuine Part
Automatic Transmission	Only use MOPAR ZF 8&9 Speed ATF Automatic Transmission Fluid or equivalent. Failure to use the correct fluid may affect the function or performance of your transmission.
Transfer Case	We recommend you use MOPAR BW44-44 Transfer Case Fluid.
Front Axle – 1500 Four-Wheel Drive Models	We recommend you use MOPAR GL-5 Synthetic Axle Lubricant SAE 75W-85.
Rear Axle	We recommend you use MOPAR Synthetic Gear Lubricant SAE 75W-140 (MS-8985). Limited-Slip Rear Axles require the addition of 5 oz. (148 ml) MOPAR Limited Slip Additive (MS-10111).
Brake Master Cylinder	We recommend you use MOPAR DOT 3 Brake Fluid, SAE J1703 should be used. If DOT 3, SAE J1703 brake fluid is not available, then DOT 4 is acceptable.

## FLUID CAPACITIES — 6.7L CUMMINS DIESEL ENGINE

	U.S.	Metric
<b>Fuel (Approximate)</b>		
2500/3500 Standard Cab Longbed Models	28 Gallons	106 Liters
2500/3500 Crew/Mega Cab Shortbed Models	31 Gallons	129 Liters
2500/3500 Crew Cab Longbed Models	32 Gallons	132 Liters
Standard Rear Tank – Chassis Cab Only	52 Gallons	197 Liters
Optional Midship Tank – Chassis Cab Only	22 Gallons	83 Liters
Diesel Exhaust Fluid Tank (Approximate) – 2500/3500 Models	5.5 Gallons	21 Liters
Diesel Exhaust Fluid Tank (Approximate) – Chassis Cab	9 Gallons	34 Liters
<b>Engine Oil With Filter</b>		
6.7L Turbo Diesel Engine	12 Quarts	11.4 Liters
<b>Cooling System</b>		
6.7L Turbo Diesel Engine (MOPAR Engine Coolant/Antifreeze 10 Year/150,000 Mile Formula)	5.7 Gallons	21.4 Liters

# MAINTAINING YOUR VEHICLE

## FLUIDS, LUBRICANTS, AND GENUINE PARTS — 6.7L CUMMINS DIESEL ENGINE

### Engine

Component	Fluid, Lubricant, or Genuine Part
Engine Coolant	We recommend you use MOPAR Antifreeze/Coolant 10 Year/150,000 Mile Formula OAT (Organic Additive Technology).
Engine Oil	In ambient temperatures above 0°F (-18°C), we recommend you use 15W-40 engine oil such as MOPAR, Shell Rotella and Shell Rimula that meets FCA Materials Standard MS-10902 and the API CJ-4 engine oil category is required. Products meeting Cummins CES 20081 may also be used. The identification of these engine oils is typically located on the back of the oil container. In ambient temperatures below 0°F (-18°C), we recommend you use 5W-40 <b>synthetic</b> engine oil such as MOPAR, Shell Rotella and Shell Rimula that meets FCA Materials Standard MS-10902 and the API CJ-4 engine oil category is required.
Engine Oil Filter	We recommend you use MOPAR Engine Oil Filters.
Fuel Filters	We recommend you use MOPAR Fuel Filter. Must meet 3 micron rating. <b>Using a fuel filter that does not meet the manufacturers filtration and water separating requirements can severely impact fuel system life and reliability.</b>
Crankcase Ventilation Filter	We recommend you use MOPAR CCV Filter.
Fuel Selection	Use good quality diesel fuel from a reputable supplier in your vehicle. Federal law requires that you must fuel this vehicle with Ultra Low Sulfur Highway Diesel fuel (15 ppm Sulfur maximum) and prohibits the use of Low Sulfur Highway Diesel fuel (500 ppm Sulfur maximum) to avoid damage to the emissions control system. For most year-round service, No. 2 diesel fuel meeting ASTM specification D-975 Grade S15 will provide good performance. If the vehicle is exposed to extreme cold (below 20°F or -7°C), or is required to operate at colder-than-normal conditions for prolonged periods, use climatized No. 2 diesel fuel or dilute the No. 2 diesel fuel with 50% No. 1 diesel fuel. This will provide better protection from fuel gelling or wax-plugging of the fuel filters. <b>This vehicle is fully compatible with biodiesel blends up to 5% biodiesel meeting ASTM specification D-975.</b> Chassis Cab models and Pickup models configured with optional B20 capability, are additionally compatible with 20% biodiesel meeting ASTM specification D-7467 provided the shortened maintenance intervals are followed as directed.
Diesel Exhaust Fluid	MOPAR Diesel Exhaust Fluid (API Certified) (DEF) or equivalent that has been API Certified to the ISO 22241 standard. Use of fluids not API Certified to ISO 22241 may result in system damage. You can receive assistance in locating DEF in the United States by calling 866-RAM-INFO (866-726-4636). In Canada call 1-800-465-2001 (English) or 1-800-387-9983 (French).

# MAINTAINING YOUR VEHICLE

## CAUTION!

- Mixing of engine coolant (antifreeze) other than specified Organic Additive Technology (OAT) engine coolant (antifreeze), may result in engine damage and may decrease corrosion protection. Organic Additive Technology (OAT) engine coolant is different and should not be mixed with Hybrid Organic Additive Technology (HOAT) engine coolant (antifreeze) or any “globally compatible” coolant (antifreeze). If a non-OAT engine coolant (antifreeze) is introduced into the cooling system in an emergency, the cooling system will need to be drained, flushed, and refilled with fresh OAT coolant (conforming to MS.90032), by an authorized dealer as soon as possible.
- Do not use water alone or alcohol-based engine coolant (antifreeze) products. Do not use additional rust inhibitors or antirust products, as they may not be compatible with the radiator engine coolant and may plug the radiator.
- This vehicle has not been designed for use with propylene glycol-based engine coolant (antifreeze). Use of propylene glycol-based engine coolant (antifreeze) is not recommended.

## Chassis

Component	Fluid, Lubricant, or Genuine Part
Automatic Transmission – If Equipped (Six-Speed 68RFE) – Pickup models without PTO	Only use ATF+4 Automatic Transmission Fluid. Failure to use ATF+4 fluid may affect the function or performance of your transmission. We recommend MOPAR ATF+4 fluid.
Automatic Transmission – If Equipped (Six-Speed AS69RC) – Pickup models with PTO, and all Chassis Cab models	Only use MOPAR ASRC Automatic Transmission Fluid or equivalent. Failure to use the proper fluid may affect the function or performance of your transmission.
Transfer Case	We recommend you use MOPAR BW44–44 Transfer Case Fluid.
Front and Rear Axle Fluid (2500/3500)	We recommend you use Synthetic, GL-5 SAE 75W-85. Limited slip additive is not required for Limited-Slip Rear Axles.
Front and Rear Axle Fluid (4500/5500)	We recommend you use Synthetic, GL-5 SAE 75W-90. Limited slip additive is not required for Limited-Slip Rear Axles.
Clutch Linkage	We recommend you use MOPAR Multi-Purpose Grease, NLGI Grade 2 E.P. or equivalent.
Manual Transmission (G-56) – If Equipped	We recommend you use MOPAR ATF+4 Automatic Transmission Fluid or equivalent licensed ATF+4 product.

# MAINTAINING YOUR VEHICLE

## MAINTENANCE PROCEDURES

For information on the maintenance procedures for your vehicle, please refer to “Maintenance Procedures” in “Maintaining Your Vehicle” in your Owner’s Manual or applicable supplement on the DVD for further details.

## MAINTENANCE SCHEDULE — GASOLINE ENGINE

Your vehicle is equipped with an automatic oil change indicator system. The oil change indicator system will remind you that it is time to take your vehicle in for scheduled maintenance.

Based on engine operation conditions, the oil change indicator message will illuminate. This means that service is required for your vehicle. Operating conditions such as frequent short-trips, trailer tow, extremely hot or cold ambient temperatures, and E85 fuel usage will influence when the “Oil Change Required” message is displayed. Severe Operating Conditions can cause the change oil message to illuminate as early as 3,500 miles (5,600 km) since last reset. Have your vehicle serviced as soon as possible, within the next 500 miles (805 km).

Your authorized dealer will reset the oil change indicator message after completing the scheduled oil change. If a scheduled oil change is performed by someone other than your authorized dealer, the message can be reset by referring to the steps described under “Instrument Cluster Warning Lights” in “What To Do In Emergencies” in this guide or “Electronic Vehicle Information Center (EVIC)” or “Driver Information Display (DID)” in “Understanding Your Instrument Panel” in your Owner’s Manual on the DVD for further information.

### 1500 Models Only

#### **NOTE:**

Under no circumstances should oil change intervals exceed 10,000 miles (16,000 km), twelve months or 350 hours of engine run time, whichever comes first. The 350 hours of engine run or idle time is generally only a concern for fleet customers.



# MAINTAINING YOUR VEHICLE

## 2500 – 3500 Models Only

### NOTE:

Under no circumstances should oil change intervals exceed 8,000 miles (13,000 km), twelve months or 350 hours of engine run time, whichever comes first. The 350 hours of engine run or idle time is generally only a concern for fleet customers.

## Severe Duty All Models Only

### NOTE:

Change Engine Oil at 4,000 miles (6,500 km) if the vehicle is operated in a dusty and off road environment or is operated predominantly at idle or only very low engine RPM's. This type of vehicle use is considered Severe Duty.

### Once A Month Or Before A Long Trip:

- Check engine oil level
- Check windshield washer fluid level
- Check tire pressure and look for unusual wear or damage. Rotate tires at the first sign of irregular wear, even if it occurs before the oil indicator system turns on.
- Check the fluid levels of the coolant reservoir, brake master cylinder, power steering (2500/3500 Models Only) and automatic transmission (six-speed only) and fill as needed
- Check function of all interior and exterior lights

## Required Maintenance

Refer to the Maintenance Schedules on the following pages for required maintenance.

<b>At Every Oil Change Interval As Indicated By Oil Change Indicator System:</b>
• Change oil and filter.
• Rotate the tires. <b>Rotate at the first sign of irregular wear, even if it occurs before the oil indicator system turns on.</b>
• Inspect battery and clean and tighten terminals as required.
• Inspect automatic transmission fluid if equipped with dipstick.
• Inspect brake pads, shoes, rotors, drums, hoses and park brake.
• Inspect engine cooling system protection and hoses.
• Inspect exhaust system.
• Inspect engine air cleaner if using in dusty or off-road conditions.
• Lube the front drive shaft fitting (2500/3500 (4x4) models only).

# MAINTAINING YOUR VEHICLE

## Maintenance Chart — Gasoline Engine

Mileage or time passed (whichever comes first)	20,000	30,000	40,000	50,000	60,000	70,000	80,000	90,000	100,000	110,000	120,000	130,000	140,000	150,000
0r Years:	2	3	4	5	6	7	8	9	10	11	12	13	14	15
Or Kilometers:	32,000	48,000	64,000	80,000	96,000	112,000	128,000	144,000	160,000	176,000	192,000	208,000	224,000	240,000
<b>Additional Inspections</b>														
Inspect the CV/Universal joints.		X			X			X			X			X
Inspect front suspension, tie rod ends, and replace if necessary.	X		X		X		X		X		X		X	
Inspect the front and rear axle surfaces. If gear oil leakage is suspected, check the fluid level. If using your vehicle for police, taxi, fleet, off-road or frequent trailer towing, change axle fluid.	X		X		X		X		X		X		X	
Inspect the brake linings, replace as necessary.	X		X		X		X		X		X		X	
Adjust parking brake as necessary.	X		X		X		X		X		X		X	
Inspect transfer case fluid.		X						X						X
<b>Additional Maintenance</b>														
Replace engine air filter.		X			X			X			X			X
Replace spark plugs.**									X					
Flush and replace the engine coolant at 10 years or 150,000 miles (240,000 km) whichever comes first.									X					X
Change automatic transmission fluid and filter(s) (six-speed automatic only), if using your vehicle for police, taxi, fleet, or frequent trailer towing.					X									

# MAINTAINING YOUR VEHICLE

Mileage or time passed (whichever comes first)	20,000	30,000	40,000	50,000	60,000	70,000	80,000	90,000	100,000	110,000	120,000	130,000	140,000	150,000
0r Years:	2	3	4	5	6	7	8	9	10	11	12	13	14	15
Or Kilometers:	32,000	48,000	64,000	80,000	96,000	112,000	128,000	144,000	160,000	176,000	192,000	208,000	224,000	240,000
Change automatic transmission fluid and filter(s) (six-speed automatic only).											X			
Inspect the transfer case fluid, change for any of the following: police, taxi, fleet, or frequent trailer towing.					X						X			
Change the transfer case fluid.											X			
Inspect and replace PCV valve if necessary.									X					

\*\* The spark plug change interval is mileage based only, yearly intervals do not apply.

## WARNING!

- You can be badly injured working on or around a motor vehicle. Do only service work for which you have the knowledge and the right equipment. If you have any doubt about your ability to perform a service job, take your vehicle to a competent mechanic.
- Failure to properly inspect and maintain your vehicle could result in a component malfunction and effect vehicle handling and performance. This could cause an accident.

# MAINTAINING YOUR VEHICLE

## MAINTENANCE RECORD

	Odometer	Date	Signature, Authorized Service Center
20,000 Miles (32,000 km) or 2 Years			
30,000 Miles (48,000 km) or 3 Years			
40,000 Miles (64,000 km) or 4 Years			
50,000 Miles (80,000 km) or 5 Years			
60,000 Miles (96,000 km) or 6 Years			
70,000 Miles (112,000 km) or 7 Years			
80,000 Miles (128,000 km) or 8 Years			

	Odometer	Date	Signature, Authorized Service Center
90,000 Miles (144,000 km) or 9 Years			
100,000 Miles (160,000 km) or 10 Years			
110,000 Miles (176,000 km) or 11 Years			
120,000 Miles (192,000 km) or 12 Years			
130,000 Miles (208,000 km) or 13 Years			
140,000 Miles (224,000 km) or 14 Years			
150,000 Miles (240,000 km) or 15 Years			

# MAINTAINING YOUR VEHICLE

## MAINTENANCE SCHEDULE — 1500 3.0L DIESEL ENGINE

Your vehicle is equipped with an automatic oil change indicator system. The oil change indicator system will remind you that it is time to take your vehicle in for scheduled maintenance.

Based on engine operation conditions, the oil change indicator message will illuminate. This means that service is required for your vehicle. Operating conditions such as frequent short-trips, trailer tow, extremely hot or cold ambient temperatures will influence when the “Oil Change Required” message is displayed. Severe Operating Conditions can cause the change oil message to illuminate as early as 3,500 miles (5,600 km) since last reset. Have your vehicle serviced as soon as possible, within the next 500 miles (805 km).

Your authorized dealer will reset the oil change indicator message after completing the scheduled oil change. If a scheduled oil change is performed by someone other than your authorized dealer, the message can be reset by referring to the steps described under “Instrument Cluster Warning Lights” in “What To Do In Emergencies” in this guide or “Electronic Vehicle Information Center (EVIC)” or “Driver Information Display (DID)” in “Understanding Your Instrument Panel” in your Owner’s Manual on the DVD for further information.

### **NOTE:**

Under no circumstances should oil change intervals exceed 10,000 miles (16,000 km) or twelve months, whichever comes first.

# MAINTAINING YOUR VEHICLE

## Once A Month Or Before A Long Trip:

- Check engine oil level
- Check windshield washer fluid level
- Check the tire inflation pressures and look for unusual wear or damage
- Check the fluid levels of the coolant reservoir, brake master cylinder and power steering, and fill as needed
- Check function of all interior and exterior lights

## Required Maintenance

Refer to the Maintenance Schedules on the following pages for required maintenance.

<b>At Every Oil Change Interval As Indicated By Oil Change Indicator System:</b>
• Change oil and filter.
• Completely fill the Diesel Exhaust Fluid tank.
• Drain water from fuel filter assembly.
• Rotate the tires. <b>Rotate at the first sign of irregular wear, even if it occurs before the oil indicator system turns on.</b>
• Inspect battery and clean and tighten terminals as required.
• Inspect brake pads, shoes, rotors, drums, hoses and park brake.
• Inspect engine cooling system protection and hoses.
• Inspect exhaust system.
• Inspect engine air cleaner if using in dusty or off-road conditions.

## Maintenance Chart — Diesel Fuel Up To B5 Biodiesel (1500 Diesel)

Mileage or time passed (whichever comes first)	10,000	20,000	30,000	40,000	50,000	60,000	70,000	80,000	90,000	100,000	110,000	120,000	130,000	140,000	150,000
Or Years:	1	2	3	4	5	6	7	8	9	10	11	12	13	14	15
Or Kilometers:	16,000	32,000	48,000	64,000	80,000	96,000	112,000	128,000	144,000	160,000	176,000	192,000	208,000	224,000	240,000
<b>Additional Inspections</b>															
Completely fill the Diesel Exhaust Fluid tank.	X	X	X	X	X	X	X	X	X	X	X	X	X	X	X
Inspect the CV/Universal joints.			X	X		X			X			X			X
Inspect front suspension, tie rod ends, and replace if necessary.				X		X		X		X		X		X	
Inspect the front and rear axle fluid. If gear oil leakage is suspected, check the fluid level. If using your vehicle for police, taxi, fleet, off-road or frequent trailer towing change the axle fluid.		X		X		X		X		X		X		X	
Inspect the brake linings, parking brake function.		X		X		X		X		X		X		X	
Inspect the transfer case fluid.			X						X						X
<b>Additional Maintenance</b>															
Drain water from fuel filter assembly.	X	X		X	X		X	X		X	X		X		
Replace fuel filter and drain water from the fuel filter assembly.			X		X				X			X			X
Replace engine air filter.			X		X				X			X			X
Flush and replace the engine coolant at 10 years or 150,000 miles (240,000 km) whichever comes first.										X					X
Replace accessory drive belt(s).									X						
Inspect the transfer case fluid, change for any of the following: police, taxi, fleet, or frequent trailer towing.						X						X			
Change transfer case fluid.															X

## **WARNING!**

- You can be badly injured working on or around a motor vehicle. Do only service work for which you have the knowledge and the right equipment. If you have any doubt about your ability to perform a service job, take your vehicle to a competent mechanic.
- Failure to properly inspect and maintain your vehicle could result in a component malfunction and effect vehicle handling and performance. This could cause an accident.

## **ADDITIONAL MAINTENANCE — B6 TO B20 BIODIESEL (1500 DIESEL)**

### **NOTE:**

- Under no circumstances should oil change intervals exceed 8,000 miles (12 875 km) or six months, whichever comes first when using Biodiesel blends greater than 5% (B5).
- The owner is required to monitor mileage for B6-B20 biodiesel, the automatic oil change indicator system does not reflect the use of biofuels.



**Additional Maintenance Chart — B6 to B20 Biodiesel (1500 Diesel)**

Mileage or time passed (whichever comes first)	10,000	20,000	30,000	40,000	50,000	60,000	70,000	80,000	90,000	100,000	110,000	120,000	130,000	140,000	150,000
	Or Years:	1	2	3	4	5	6	7	8	9	10	11	12	13	14
Or Kilometers:	16,000	32,000	48,000	64,000	80,000	96,000	112,000	128,000	144,000	160,000	176,000	192,000	208,000	224,000	240,000

**Additional B6 to B20 Maintenance**

Replace fuel filter and drain water from the fuel filter assembly.

	X			X				X		X			X		
--	---	--	--	---	--	--	--	---	--	---	--	--	---	--	--

**WARNING!**

- You can be badly injured working on or around a motor vehicle. Do only service work for which you have the knowledge and the right equipment. If you have any doubt about your ability to perform a service job, take your vehicle to a competent mechanic.
- Failure to properly inspect and maintain your vehicle could result in a component malfunction and effect vehicle handling and performance. This could cause an accident.

# MAINTAINING YOUR VEHICLE

## MAINTENANCE RECORD

	Odometer	Date	Signature, Authorized Service Center
20,000 Miles (32,000 km) or 2 Years			
30,000 Miles (48,000 km) or 3 Years			
40,000 Miles (64,000 km) or 4 Years			
50,000 Miles (80,000 km) or 5 Years			
60,000 Miles (96,000 km) or 6 Years			
70,000 Miles (112,000 km) or 7 Years			
80,000 Miles (128,000 km) or 8 Years			

	Odometer	Date	Signature, Authorized Service Center
90,000 Miles (144,000 km) or 9 Years			
100,000 Miles (160,000 km) or 10 Years			
110,000 Miles (176,000 km) or 11 Years			
120,000 Miles (192,000 km) or 12 Years			
130,000 Miles (208,000 km) or 13 Years			
140,000 Miles (224,000 km) or 14 Years			
150,000 Miles (240,000 km) or 15 Years			

# MAINTAINING YOUR VEHICLE

## MAINTENANCE SCHEDULE — 6.7L CUMMINS DIESEL ENGINE

### CAUTION!

Failure to perform the required maintenance items may result in damage to the vehicle.

#### At Each Stop For Fuel

Check the engine oil level at least 30 minutes after a fully warmed engine is shut off. Checking the oil level while the vehicle is on level ground will improve the accuracy of the oil level reading. Add oil only when the level is at or below the ADD or MIN mark.

#### Once A Month

- Inspect the batteries, and clean and tighten the terminals as required.
- Check the fluid levels of the coolant reservoir, brake master cylinder, and automatic transmission (if equipped), and add as needed.

#### At Each Oil Change

- Change the engine oil filter.
- Inspect the exhaust system.
- Inspect engine air filter.
- Check the coolant level, hoses, and clamps.
- Lubricate outer tie rod ends.

Inspection and service should also be performed anytime a malfunction is observed or suspected. Retain all receipts.

# MAINTAINING YOUR VEHICLE

## Oil Change Indicator System — Cummins Diesel

Your vehicle is equipped with an engine oil change indicator system. This system will alert you when it is time to change your engine oil by displaying the words “Oil Change Due” on your Electronic Vehicle Information Center (EVIC) or Driver Information Display (DID). The oil change reminder will remind the owner to change the engine oil every 15,000 miles or 500 hours, whichever comes first, except for the Chassis Cab models and Pickup models configured with optional B20 capability that are using B20 biodiesel, which are 12,500 miles or 400 hours, whichever comes first. Failure to change the engine oil per the maintenance schedule can result in internal engine damage.

Your authorized dealer will reset the oil change indicator message after completing the scheduled oil change. If a scheduled oil change is performed by someone other than your authorized dealer, the message can be reset by referring to the steps described under “Instrument Cluster Warning Lights” in “What To Do In Emergencies” in this guide or “Electronic Vehicle Information Center (EVIC)” or “Driver Information Display (DID)” in “Understanding Your Instrument Panel” in your Owner’s Manual on the DVD for further information.

**Replace the engine oil and oil filter every 15,000 miles (24 000 km) or six months, or sooner if prompted by the oil change indicator system. Under no circumstances should oil change intervals exceed 15,000 miles (24 000 km) or six months, whichever comes first.**

### NOTE:

- Under no circumstances should oil change intervals exceed 15,000 miles (24,000 km) or six months or 500 Hours, whichever comes first.
- Replace the engine oil and oil filter every 12,500 miles (20 000 km) when running B20 fuel (Chassis Cab Only).

If Chassis Cab models and Pickup models configured with optional B20 capability are operated with greater than 5% levels of Biodiesel, the oil change interval must not exceed 12,500 miles (20 000 km) under any circumstances. See the Fuel Requirements section for more information regarding operation of Chassis Cab models and Pickup models configured for use with Biodiesel blend (B6-B20) fuel meeting ASTM specification D-7467.

## Perform Service Indicator — Cummins Diesel

Your vehicle will require emissions maintenance at a set interval. To help remind you when this maintenance is due, the Electronic Vehicle Information Center (EVIC) or Driver information Display (DID) will display “Perform Service”. When the “Perform Service” message is displayed on the EVIC/DID it is necessary to have the emissions maintenance performed. Emissions maintenance may include replacing the Closed Crankcase Ventilation (CCV) filter element. The procedure for clearing and resetting the “Perform Service” indicator message is located in the appropriate Service Information.

## Maintenance Chart — Cummins Diesel Engine

Mileage or time passed (whichever comes first):	7,500	15,000	22,500	30,000	37,500	45,000	52,500	60,000	67,500	75,000	82,500	90,000	97,500	105,000	112,500	120,000	127,500	135,000	142,500	150,000	
Or Months:	9	12	18	24	30	36	42	48	54	60	66	72	78	84	90	96	102	108	114	120	
Or Kilometers:	12,000	24,000	36,000	48,000	60,000	72,000	84,000	96,000	108,000	120,000	132,000	144,000	156,000	168,000	180,000	192,000	204,000	216,000	228,000	240,000	
Change engine oil every 15,000 miles (24,000 km) or six months or 500 Hours or sooner if prompted by the oil change indicator system, whichever comes first. **	X	X	X	X	X	X	X	X	X	X	X	X	X	X	X	X	X	X	X	X	X
<b>Additional Inspections</b>																					
Check the Diesel Exhaust Fluid (DEF) tank, refill if necessary.	X	X	X	X	X	X	X	X	X	X	X	X	X	X	X	X	X	X	X	X	X
Rotate the tires.	X	X	X	X	X	X	X	X	X	X	X	X	X	X	X	X	X	X	X	X	X
Lubricate front drive shaft fitting (4x4).	X	X	X	X	X	X	X	X	X	X	X	X	X	X	X	X	X	X	X	X	X
Lubricate outer tie rod ends.	X	X	X	X	X	X	X	X	X	X	X	X	X	X	X	X	X	X	X	X	X
Inspect engine air filter, replace if necessary. ****		X		X		X		X		X		X		X		X		X		X	
Inspect the front suspension, tie rod ends and boot seals for cracks or leaks and all parts for damage, wear, improper looseness or end play; replace if necessary.		X		X		X		X		X		X		X		X		X		X	
Inspect the brake linings.			X			X		X		X		X		X		X		X		X	
Inspect and adjust parking brake.			X			X		X		X		X		X		X		X		X	
Inspect drive belt; replace as necessary.			X			X		X		X		X		X		X		X		X	
Inspect wheel bearings.				X				X				X				X				X	

# MAINTAINING YOUR VEHICLE

Mileage or time passed (whichever comes first);	150,000	142,500	135,000	127,500	120,000	112,500	105,000	97,500	90,000	82,500	75,000	67,500	60,000	52,500	45,000	37,500	30,000	22,500	15,000	7,500	
	120	114	108	102	96	90	84	78	72	66	60	54	48	42	36	30	24	18	12	6	
Or Months:	240,000	228,000	216,000	204,000	192,000	180,000	168,000	156,000	144,000	132,000	120,000	108,000	96,000	84,000	72,000	60,000	48,000	36,000	24,000	12,000	
Or Kilometers:																					
<b>Additional Maintenance</b>																					
Replace engine fuel filter element.	X		X		X		X		X		X		X		X		X		X		X
Replace chassis mounted fuel filter element.			X		X		X		X		X		X		X		X		X		X
Inspect the front and rear axle surfaces. If gear oil leakage is suspected, check the fluid level. If using your vehicle for police, taxi, fleet, off-road or frequent trailer towing change the axle fluid. *																					
Inspect the transfer case fluid (4x4), change for any of the following: police, taxi, fleet, or frequent trailer towing.					X				X				X				X				X
Change the transfer case fluid (4x4).					X				X				X				X				X
Change automatic transmission fluid (AS69RC transmission only).					X				X				X				X				X
Change the automatic transmission fluid and sump filter (AS69RC transmission only).					X				X				X				X				X
Change automatic transmission fluid and filter(s) if using your vehicle for any of the following: police, fleet, or frequent trailer towing (68RFE transmission only).					X				X				X				X				X
Change automatic transmission fluid and filter(s).					X				X				X				X				X

# MAINTAINING YOUR VEHICLE

Mileage or time passed (whichever comes first):	7,500	15,000	22,500	30,000	37,500	45,000	52,500	60,000	67,500	75,000	82,500	90,000	97,500	105,000	112,500	120,000	127,500	135,000	142,500	150,000	
	6	12	18	24	30	36	42	48	54	60	66	72	78	84	90	96	102	108	114	120	
Or Months:	12,000	24,000	36,000	48,000	60,000	72,000	84,000	96,000	108,000	120,000	132,000	144,000	156,000	168,000	180,000	192,000	204,000	216,000	228,000	240,000	
Or Kilometers:																					
Change the manual transmission fluid if using your vehicle for any of the following: police, fleet, or frequent trailer towing.							X									X					
Replace Crankcase Ventilation Filter (CCV).									X									X			
Flush and replace power steering fluid.													X								
Flush and replace engine coolant. ***																				X	
Adjust valve lash clearance.																					X

Inspection and service should also be performed anytime a malfunction is observed or suspected. Retain all receipts.

\* Inspect the front and rear axle surfaces every 20,000 miles (32,000 km). If gear oil leakage is suspected, check the fluid level. If using your vehicle for police, taxi, fleet, off-road or frequent trailer towing change the axle fluid every 20,000 miles (32,000 km).

\*\* Under no circumstances should oil change intervals exceed 15,000 miles (24 000 km) or six months or 500 Hours, whichever comes first.

\*\*\* Under no circumstances should the air cleaner filter element exceed 30,000 miles (48,000 km) or 24 months, whichever comes first.

## CAUTION!

\*\*\*The manufacturer highly recommends that all cooling system service, maintenance, and repairs be performed by your local authorized dealer.

# MAINTAINING YOUR VEHICLE

## **WARNING!**

- You can be badly injured working on or around a motor vehicle. Do only service work for which you have the knowledge and the right equipment. If you have any doubt about your ability to perform a service job, take your vehicle to a competent mechanic.
- Failure to properly inspect and maintain your vehicle could result in a component malfunction and effect vehicle handling and performance. This could cause an accident.



# MAINTAINING YOUR VEHICLE

## Maintenance Record — Cummins Diesel Engine

	Odometer	Date	Signature, Authorized Service Center
7,500 Miles (12,000 km) or 6 Months			
15,000 Miles (24,000 km) or 12 Months			
22,500 Miles (36,000 km) or 18 Months			
30,000 Miles (48,000 km) or 24 Months			
37,500 Miles (60,000 km) or 30 Months			
45,000 Miles (72,000 km) or 36 Months			
52,500 Miles (84,000 km) or 42 Months			
60,000 Miles (96,000 km) or 48 Months			

	Odometer	Date	Signature, Authorized Service Center
67,500 Miles (108,000 km) or 54 Months			
75,000 Miles (120,000 km) or 60 Months			
82,500 Miles (132,000 km) or 66 Months			
90,000 Miles (144,000 km) or 72 Months			
97,500 Miles (156,000 km) or 78 Months			
105,000 Miles (168,000 km) or 84 Months			
112,500 Miles (180,000 km) or 90 Months			
120,000 Miles (192,000 km) or 96 Months			

# MAINTAINING YOUR VEHICLE

	Odometer	Date	Signature, Authorized Service Center
142,500 Miles (228,000 km) or 114 Months			
150,000 Miles (240,000 km) or 120 Months			

	Odometer	Date	Signature, Authorized Service Center
127,500 Miles (204,000 km) or 102 Months			
135,000 Miles (216,000 km) or 108 Months			

## FUSES

### WARNING!

- When replacing a blown fuse, always use an appropriate replacement fuse with the same amp rating as the original fuse. Never replace a fuse with another fuse of higher amp rating. Never replace a blown fuse with metal wires or any other material. Failure to use proper fuses may result in serious personal injury, fire and/or property damage.
- Before replacing a fuse, make sure that the ignition is off and that all the other services are switched off and/or disengaged.
- If the replaced fuse blows again, contact an authorized dealer.
- If a general protection fuse for safety systems (air bag system, braking system), power unit systems (engine system, gearbox system) or steering system blows, contact an authorized dealer.

### Power Distribution Center

The Power Distribution Center is located in the engine compartment near the battery. This center contains cartridge fuses, micro fuses, relays, and circuit breakers. A description of each fuse and component may be stamped on the inside cover, otherwise the cavity number of each fuse is stamped on the inside cover that corresponds to the following chart.

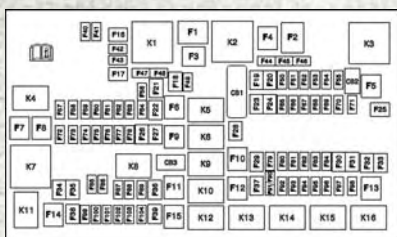

Cavity	Cartridge Fuse	Micro Fuse	Description
F01	80 Amp Black	–	Rad Fan Control Module – If Equipped
F03	60 Amp Yellow	–	Rad Fan – If Equipped
F05	40 Amp Green	–	Compressor for Air Suspension – If Equipped
F06	40 Amp Green	–	Antilock Brakes/Electronic Stability Control Pump
F07	40 Amp Green	–	Starter Solenoid
F08	20 Amp Blue (1500 LD/ Cummins Diesel)	–	Emissions Diesel – If Equipped

# MAINTAINING YOUR VEHICLE

Cavity	Cartridge Fuse	Micro Fuse	Description
F09	40 Amp Green (Special Services Vehicle & Cummins Diesel) 30 Amp Pink (1500 LD Diesel)	–	Diesel Fuel Heater – If Equipped
F10	40 Amp Green	–	Body Controller / Exterior Lighting #2
F10	50 Amp Red	–	Body Controller / Exterior Lighting #2 – If Equipped with Stop/Start
F11	30 Amp Pink	–	Integrated Trailer Brake Module – If Equipped
F12	40 Amp Green	–	Body Controller #3 / Power Locks
F13	40 Amp Green	–	Blower Motor
F14	40 Amp Green	–	Body Controller #4 / Interior Lighting
F16	30 Amp Pink	–	Smart Bar – If Equipped
F19	20 Amp Blue (1500 LD Diesel) 30 Amp Pink (Cummins Diesel)	–	SCR – If Equipped
F20	30 Amp Pink	–	Passenger Door Module
F21	30 Amp Pink	–	Drive Train Control Module
F22	20 Amp Blue 30 Amp Pink (Cummins Diesel)	–	Engine Control Module
F23	30 Amp Pink	–	Body Controller #1 / Interior Lighting
F24	30 Amp Pink	–	Driver Door Module
F25	30 Amp Pink	–	Front Wiper
F26	30 Amp Pink	–	Antilock Brakes / Stability Control Module / Valves
F28	20 Amp Blue	–	Trailer Tow Backup Lights – If Equipped
F29	20 Amp Blue	–	Trailer Tow Parking Lights – If Equipped
F30	30 Amp Pink	–	Trailer Tow Receptacle
F31	30 Amp Pink (1500 LD Diesel)	–	Urea Heater Control – If Equipped
F32	–	–	Spare Fuse
F33	20 Amp Blue	–	Special Services Vehicle Only

# MAINTAINING YOUR VEHICLE

Cavity	Cartridge Fuse	Micro Fuse	Description
F34	30 Amp Pink	–	Vehicle System Interface Module #2 – If Equipped
F35	30 Amp Pink	–	Sunroof – If Equipped
F36	30 Amp Pink	–	Rear Defroster – If Equipped
F37	30 Amp Pink	–	Cummins Diesel Fuel Heater #2 – If Equipped
F38	30 Amp Pink	–	Power Inverter 115V AC – If Equipped
F39	20 Amp Blue	–	Power Outlet – Special Services Only
F41	–	10 Amp Red	Active Grill Shutter – If Equipped
F42	–	20 Amp Yellow	Horn
F44	–	10 Amp Red	Diagnostic Port
F46	–	10 Amp Red	Upfitter – If Equipped
F49	–	10 Amp Red	Instrument Panel Cluster
F50	–	20 Amp Yellow	Air Suspension Control Module – If Equipped
F51	–	10 Amp Red	Ignition Node Module / Keyless Ignition
F52	–	5 Amp Tan	Battery Sensor
F53	–	20 Amp Yellow	Trailer Tow – Left Turn/Stop Lights
F54	–	20 Amp Yellow	Adjustable Pedals
F56	–	15 Amp Blue	Additional Diesel Content – If Equipped
F57	–	20 Amp Yellow	Transmission
F58	–	20 Amp Yellow	Spare Fuse
F59	–	10 Amp Red	SCR Relay – If Equipped
F60	–	15 Amp Blue	Underhood Lamp
F61	–	10 Amp Red (1500 LD Diesel & Cummins Diesel)	PM Sensor – If Equipped
F62	–	10 Amp Red	Air Conditioning Clutch
F63	–	20 Amp Yellow	Ignition Coils (Gas), Urea Heater (Cummins Diesel)
F64	–	25 Amp Clear	Fuel Injectors / Powertrain
F65	–	–	Spare Fuse
F66	–	10 Amp Red	Sunroof / Passenger Window Switches / Rain Sensor
F67	–	10 Amp Red	CD / DVD / Bluetooth Hands-free Module – If Equipped
F69	–	15 Amp Blue	Mod SCR 12V (Cummins Diesel) – If Equipped
F70	–	30 Amp Green	Fuel Pump Motor
F71	–	25 Amp Clear	Amplifier

# MAINTAINING YOUR VEHICLE

Cavity	Cartridge Fuse	Micro Fuse	Description
F72	–	10 Amp Red	PCM – If Equipped
F73	–	20 Amp Yellow	Fuel Transfer Pump (HD Only) – If Equipped
F74	–	20 Amp Yellow (Gas Engine & 1500 LD Diesel)	Brake Vacuum Pump Gas/Diesel – If Equipped
F75	–	10 Amp Red	Coolant Temperature Valve Actuator
F76	–	10 Amp Red	Antilock Brakes / Electronic Stability Control
F77	–	10 Amp Red	Drivetrain Control Module/Front Axle Disconnect Module
F78	–	10 Amp Red	Engine Control Module / Electric Power Steering
F79	–	15 Amp Blue	Clearance Lights
F80	–	10 Amp Red	Universal Garage Door Opener / Compass
F81	–	20 Amp Yellow	Trailer Tow Right Turn / Stop Lights
F82	–	10 Amp Red	Steering Column Control Module / Cruise Control
F84	–	15 Amp Blue	Switch Bank / Instrument Cluster
F85	–	10 Amp Red	Airbag Module
F86	–	10 Amp Red	Airbag Module
F87	–	10 Amp Red	Air Suspension – If Equipped / Trailer Tow / Steering Column Control Module
F88	–	15 Amp Blue	Instrument Panel Cluster
F90/F91	–	20 Amp Yellow	Power Outlet (rear seats) Customer Selectable
F93	–	20 Amp Yellow	Cigar Lighter
F94	–	10 Amp Red	Shifter / Transfer Case Module
F95	–	10 Amp Red	Rear Camera / Park Assist
F96	–	10 Amp Red	Rear Seat Heater Switch
F97	–	25 Amp Clear	Rear Heated Seats & Heated Steering Wheel – If Equipped
F98	–	25 Amp Clear	Front Heated Seats – If Equipped
F99	–	10 Amp Red	Climate Control
F100	–	10 Amp Red	Upfitters – If Equipped
F101	–	15 Amp Blue	Electrochromatic Mirror / Smart High Beams – If Equipped
F104	–	20 Amp Yellow	Power Outlets (Instrument Panel / Center Console)

# MAINTAINING YOUR VEHICLE

## CAUTION!

- When installing the power distribution center cover, it is important to ensure the cover is properly positioned and fully latched. Failure to do so may allow water to get into the power distribution center and possibly result in an electrical system failure.
- When replacing a blown fuse, it is important to use only a fuse having the correct amperage rating. The use of a fuse with a rating other than indicated may result in a dangerous electrical system overload. If a properly rated fuse continues to blow, it indicates a problem in the circuit that must be corrected.

## TIRES — GENERAL INFORMATION

### TIRE PRESSURES

Check the inflation pressure of each tire, including the spare tire (if equipped), at least monthly and inflate to the recommended pressure for your vehicle.

The tire pressures recommended for your vehicle are found on the “Tire and Loading Information” label located on the driver’s side door opening or B pillar.

#### NOTE:

Refer to the Owner’s Manual on the DVD or the Tire Information Supplement located in your Owner’s Information kit for more information regarding tire warnings and instructions.



Tire And Loading Information Location  
(Example)

# MAINTAINING YOUR VEHICLE

## WARNING!

- Overloading of your tires is dangerous. Overloading can cause tire failure, affect vehicle handling, and increase your stopping distance. Use tires of the recommended load capacity for your vehicle. Never overload them.
- Improperly inflated tires are dangerous and can cause collisions. Under-inflation increases tire flexing and can result in over-heating and tire failure. Over-inflation reduces a tire's ability to cushion shock. Objects on the road and chuck holes can cause damage that results in tire failure. Unequal tire pressures can cause steering problems. You could lose control of your vehicle. Over-inflated or under-inflated tires can affect vehicle handling and can fail suddenly, resulting in loss of vehicle control. Always drive with each tire inflated to the recommended cold tire inflation pressure.

## SPARE TIRES — IF EQUIPPED

### NOTE:

For vehicles equipped with Tire Service Kit instead of a spare tire, please refer to “Tire Service Kit” in “What To Do In Emergencies” on your DVD for further information.

## CAUTION!

Because of the reduced ground clearance, do not take your vehicle through an automatic car wash with a compact or limited-use temporary spare installed. Damage to the vehicle may result.

## Spare Tire Matching Original Equipped Tire And Wheel — If Equipped

Your vehicle may be equipped with a spare tire and wheel equivalent in look and function to the original equipment tire and wheel found on the front or rear axle of your vehicle. This spare tire may be used in the tire rotation for your vehicle. If your vehicle has this option, refer to an authorized tire dealer for the recommended tire rotation pattern.

## Compact Spare Tire — If Equipped

The compact spare is for temporary emergency use only. You can identify if your vehicle is equipped with a compact spare by looking at the spare tire description on the Tire and Loading Information Placard located on the driver's side door opening or on the sidewall of the tire. Compact spare tire descriptions begin with the letter “T” or “S” preceding the size designation. Example: T145/80D18 103M.

T, S = Temporary Spare Tire

Since this tire has limited tread life, the original equipment tire should be repaired (or replaced) and reinstalled on your vehicle at the first opportunity.



# MAINTAINING YOUR VEHICLE

Do not install a wheel cover or attempt to mount a conventional tire on the compact spare wheel, since the wheel is designed specifically for the compact spare tire. Do not install more than one compact spare tire and wheel on the vehicle at any given time.

## WARNING!

Compact spares are for temporary emergency use only. With these spares, do not drive more than 50 mph (80 km/h). Temporary use spares have limited tread life. When the tread is worn to the tread wear indicators, the temporary use spare tire needs to be replaced. Be sure to follow the warnings, which apply to your spare. Failure to do so could result in spare tire failure and loss of vehicle control.

### Full Size Spare — If Equipped

The full size spare is for temporary emergency use only. This tire may look like the originally equipped tire on the front or rear axle of your vehicle, but it is not. This spare tire may have limited tread life. When the tread is worn to the tread wear indicators, the temporary use full size spare tire needs to be replaced. Since it is not the same as your original equipment tire, replace (or repair) the original equipment tire and reinstall on the vehicle at the first opportunity.

### Limited Use Spare — If Equipped

The limited-use spare tire is for temporary emergency use only. This tire is identified by a label located on the limited-use spare wheel. This label contains the driving limitations for this spare. This tire may look like the original equipped tire on the front or rear axle of your vehicle, but it is not. Installation of this limited-use spare tire affects vehicle handling. Since it is not the same as your original equipment tire, replace (or repair) the original equipment tire and reinstall on the vehicle at the first opportunity.

## WARNING!

Limited-use spares are for emergency use only. Installation of this limited-use spare tire affects vehicle handling. With this tire, do not drive more than the speed listed on the limit-use spare wheel. Keep inflated to the cold tire inflation pressures listed on your Tire and Loading Information Placard located on the driver's side B-Pillar or the rear edge of the driver's side door. Replace (or repair) the original equipment tire at the first opportunity and reinstall it on your vehicle. Failure to do so could result in loss of vehicle control.

## WHEEL AND WHEEL TRIM CARE

All wheels and wheel trim, especially aluminum and chrome plated wheels, should be cleaned regularly with a mild soap and water to prevent corrosion.

To remove heavy soil and/or excessive brake dust, use MOPAR Wheel Cleaner or equivalent or select a non-abrasive, non-acidic cleaner.

# MAINTAINING YOUR VEHICLE

## CAUTION!

Do not use scouring pads, steel wool, a bristle brush, or metal polishes. Do not use oven cleaner. These products may damage the wheel's protective finish. Avoid automatic car washes that use acidic solutions or harsh brushes that may damage the wheel's protective finish. Only MOPAR Wheel Cleaner or equivalent is recommended.

## REPLACEMENT BULBS

All of the inside bulbs are brass or glass-wedge base. Aluminum base bulbs are not approved.

### Interior Bulbs

	<b>Bulb Number</b>
Overhead Console Lamps	TS 212-9
Dome Lamp	7679
For lighted switches, see your authorized dealer for replacement instructions.	

### Exterior Bulbs

	<b>Bulb Number</b>
Base Quad Headlamp – Low Beam	H11LL
Base Quad Headlamp – High Beam	9005LL
Front Turn Signal Lamp (Base Quad Headlamp)	3157NA
Premium Bi Halogen Projector Headlamp - Low Beam	9005SI+
Premium Bi Halogen Projector Headlamp - High Beam	9005LL
Front Turn Signal Lamp (Premium Headlamp)	LED (Serviced at Authorized Dealer)
Fog Lamp (Horizontal shape)	9145
Fog Lamp (Vertical shape)	9006
Center High Mounted Stop Lamp (CHMSL)	921K
Rear Cargo Lamp	921
LED Center High Mounted Stop Lamp (CHMSL)/Cargo Lamp	LED (Serviced at Authorized Dealer)
Cab Roof Marker Lamps	194NA
Base Rear Tail/Turn and Stop Lamp	3157K
Premium Rear Tail/Turn and Stop Lamp	LED (Serviced at Authorized Dealer)
Premium Backup Lamp	7440/W21W
Rear Lamp Bar ID Marker Lamp	194
Side Marker Lamps (Dual Rear Wheels)	194
Backup Lamp	921
Rear License Plate Lamp	194

# CUSTOMER ASSISTANCE

## FCA US LLC CUSTOMER CENTER

P.O. Box 21-8004 Auburn Hills, MI 48321-8004 Phone: 1-866-726-4636

## FCA CANADA INC. CUSTOMER CENTER

P.O. Box 1621 Windsor, Ontario N9A 4H6 Phone: 1-800-465-2001 (English)  
Phone: 1-800-387-9983 (French)

## ASSISTANCE FOR THE HEARING IMPAIRED

To assist customers who have hearing difficulties, the manufacturer has installed special TDD (Telecommunication Devices for the Deaf) equipment at its customer center. Any hearing or speech impaired customer, who has access to a TDD or a conventional teletypewriter (TTY) in the United States, can communicate with the manufacturer by dialing 1-800-380-CHRY. Canadian residents with hearing difficulties that require assistance can use the special needs relay service offered by Bell Canada. For TTY teletypewriter users, dial 711 and for Voice callers, dial 1-800-855-0511 to connect with a Bell Relay Service operator.

### WARNING!

Engine exhaust, some of its constituents, and certain vehicle components contain, or emit, chemicals known to the State of California to cause cancer and birth defects, or other reproductive harm. In addition, certain fluids contained in vehicles and certain products of component wear contain, or emit, chemicals known to the State of California to cause cancer and birth defects, or other reproductive harm.

## PUBLICATIONS ORDERING

- If you are the first registered retail owner of your vehicle, you may obtain a complimentary printed copy of the Owner's Manual, Navigation/Uconnect Manuals or Warranty Booklet. United States customers may visit the Ram Truck Contact Us page at [www.ramtrucks.com](http://www.ramtrucks.com) scroll to the bottom of the page and select the "Contact Us" link, then select the "Owner's Manual and Glove Compartment Material" from the left menu. You may also obtain a complimentary copy by calling 1-866-726-4636 (U.S.) or 1-800-387-1143 (Canada).
- Replacement User Guide kits or DVDs or, if you prefer, additional printed copies of the Owner's Manual, Warranty Booklet or Radio Manuals may be purchased by visiting [www.techauthority.com](http://www.techauthority.com) or by calling 1-800-890-4038 (U.S.) or 1-800-387-1143 (Canada). Visa, Master Card, American Express and Discover orders are accepted. If you prefer mailing your order, please call the above numbers for an order form.

# CUSTOMER ASSISTANCE

## NOTE:

- A street address is required when ordering manuals (no P.O. Boxes).
- The Owner's Manual and User Guide electronic files are also available on the Chrysler, Jeep®, Ram Truck, Dodge and SRT websites.
- Click on the "Owners" tab, select "Owner And Service Manuals", then select your desired model year and vehicle from the drop down lists.

## REPORTING SAFETY DEFECTS IN THE UNITED STATES

If you believe that your vehicle has a defect that could cause a collision or cause injury or death, you should immediately inform the National Highway Traffic Safety Administration (NHTSA) in addition to notifying the manufacturer.

If NHTSA receives similar complaints, it may open an investigation, and if it finds that a safety defect exists in a group of vehicles, it may order a recall and remedy campaign. However, NHTSA cannot become involved in individual problems between you, your authorized dealer and the manufacturer.

To contact NHTSA, you may either call the Auto Safety Hotline toll free at 1-888-327-4236 (TTY: 1-800-424-9153), or go to <http://www.safercar.gov>; or write to: Administrator, NHTSA, 1200 New Jersey Avenue, SE., West Building, Washington, D.C. 20590. You can also obtain other information about motor vehicle safety from <http://www.safercar.gov>.

## In Canada

If you believe that your vehicle has a safety defect, you should contact the Customer Service Department immediately. Canadian customers who wish to report a safety defect to the Canadian government should contact Transport Canada, Motor Vehicle Defect Investigations and Recalls at 1-800-333-0510 or go to <http://www.tc.gc.ca/roadsafety/>.

French Canadian customers who wish to report a safety defect to the Canadian government should contact Transport Canada, Motor Vehicle Defect Investigations and Recalls at 1-800-333-0510 or go to <http://www.tc.gc.ca/securiteroutiere/>.

## AUTHENTIC ACCESSORIES BY MOPAR

- In choosing Authentic Accessories you gain far more than expressive style, premium protection, or extreme entertainment, you also benefit from enhancing your vehicle with accessories that have been thoroughly tested and factory-approved.
- The following highlights just some of the many Authentic Ram Accessories by Mopar featuring a fit, finish, and functionality specifically for your Ram.
- For the full line of Authentic Ram Accessories by Mopar, visit your local dealership or online at [mopar.com](http://mopar.com) for U.S. residents and [mopar.ca](http://mopar.ca) for Canadian residents.

### NOTE:

All parts are subject to availability.

#### CHROME:

- Exhaust Tip
- Tubular Side Steps
- Fuel Filler Door
- Cast Aluminum Wheels
- Front Air Deflector
- Grille
- Body Side Molding

#### EXTERIOR:

- Bedliners
- Running Boards
- Bed Mat & Bed Rug
- Fiberglass Tonneau Cover
- Bed Extender
- Tool Box
- Roll-up Tonneau Cover
- Bed Step
- Sport Performance Hood
- Folding Tonneau Cover
- Hitch Receiver
- Hitches
- Molded Splash Guards

#### INTERIOR:

- Premium Carpet Mats
- Door Sill Guards
- Slush Mats
- Leather Seats
- Bright Pedal Kit

#### ELECTRONICS:

- Kicker Sound Systems
- Remote Start
- Mopar Connect
- Electronic Vehicle Tracking

#### CARRIERS:

- Bed Mounted Bike Carrier
- Cargo Bed Divider
- Cargo Ramps
- Bed Mounted Ski and Snowboard Carrier
- Bed Mounted Cargo Basket With Cargo Net

Kicker is a registered trademark of Stillwater Designs and Audio, Inc.

## FREQUENTLY ASKED QUESTIONS

### GETTING STARTED

How do I install my LATCH Equipped Child Seat? pg. 23

How do I program my Front Seat Memory? pg. 33

### OPERATING YOUR VEHICLE

How does the Electronic Range Select (ERS) operate? pg. 50

### ELECTRONICS

Which radio is in my vehicle?

- Uconnect 3.0 pg. 92
- Uconnect 5.0 pg. 99
- Uconnect 8.4A/8.4AN pg. 111

How do I activate the Audio Jack?

- Uconnect 3.0 pg. 94
- Uconnect 5.0 pg. 103
- Uconnect 8.4A/8.4AN pg. 118

How do I set the clock on my radio?

- Uconnect 3.0 pg. 93
- Uconnect 5.0 pg. 100
- Uconnect 8.4A/8.4AN pg. 111

How do I use the Navigation feature? pg. 121

How do I pair my cell phone via Bluetooth with the Uconnect Hands-Free Voice Activation System? pg. 146

How do I use my USB port to listen to audio through my touch-screen radio? pg. 118

## **OFF-ROAD CAPABILITIES**

How do I shift into different four-wheel drive selections? pg. 166

## **UTILITY**

How do I know how much I can tow with my Ram Truck? pg. 176

How do I adjust the gain on the Integrated Trailer Brake Module? pg. 177

## **WHAT TO DO IN EMERGENCIES**

How do I change a flat tire? pg. 217

How do I Jump-Start my vehicle? pg. 230

## **MAINTAINING YOUR VEHICLE**

Where is my Fuse Block located? pg. 281

What type of oil do I use? pg. 254

How often should I change my engine's oil?

- Gasoline Engine pg. 262
- Cummins Diesel Engine pg. 273
- 1500 Diesel Engine pg. 267

# INDEX

- Access
  - Uconnect . . . . .77, 79, 83
- Adding Engine Coolant (Antifreeze).262
- Adding Washer Fluid . . . . .262
- Adjust
  - Down . . . . .31
  - Forward . . . . .31
  - Rearward . . . . .31
  - Up . . . . .31
- Adjustable Pedals . . . . .41
- Aftermarket . . . . .5
- Air Bag
  - Advanced Front Air Bag . . . . .18
  - Advance Front Air Bag . . . . .17
  - Air Bags . . . . .17
  - Air Bag Warning Light .17, 20, 213
  - Enhanced Accident Response . . . . .20, 240
  - Event Data Recorder (EDR) .21, 240
  - Front Air Bag . . . . .17
  - Rollover . . . . .17
  - Side Air Bags . . . . .19
  - Side Impacts . . . . .17
- Air Bag Light . . . . .20
- Air Cleaner, Engine
  - (Engine Air Cleaner Filter) . . . .262
- Air Conditioner Maintenance . . . .262
- Air Conditioning . . . .61, 62, 64, 65
- Air Conditioning Refrigerant . . . .262
- Air Conditioning System . . . . .262
- Air Suspension . . . . .51, 54, 56
- Alarm
  - Arm The System . . . . .15
  - Disarm The System . . . . .16
  - Vehicle Security Alarm . . . . .15
- Alarm (Security Alarm) . . . . .15, 215
- Antifreeze (Engine Coolant) . .254, 262
  - Capacities . . . . .257, 259
  - Disposal . . . . .262
- Anti-Lock Brake System (ABS) . . .213
- APP
  - Uconnect Access . . . . .80
- Appearance Care . . . . .262
- Assistance Towing . . . . .209
- Audio Jack . . . . .103, 118
- Automatic Headlights . . . . .45, 216
- Automatic High Beams . . . . .45
- Automatic Temperature Control (ATC).64
- Automatic Transmission
  - Fluid Type . . . . .256, 259, 261
- Axle Fluid. . . . .256, 259, 261
- Background Themes
  - Uconnect 8.4A . . . . .111
  - Uconnect 8.4N . . . . .111, 127
- Back-Up Camera . . . . .67
- Battery . . . . .262
  - Charging System Light . . . . .212
- Body Mechanism Lubrication . . . .262
- Brake Fluid . . . . .256, 259
- Brakes . . . . .262
- Brake System . . . . .262
  - Master Cylinder . . . . .262
  - Warning Light . . . . .211
- Break-In Recommendations, New Vehicle . . . . .43
- Bulb Replacement . . . . .288
- Bulbs, Light . . . . .288
- Calibration, Compass . . . . .156
- Camera, Rear . . . . .67
- Canada . . . . .4, 290
- Capacities, Antifreeze (Engine Coolant) . . . . .257, 259
- Capacities, Fluid. . . . .254, 257, 259
- Capacity
  - Cargo Weight . . . . .176
  - Payload . . . . .176
  - Towing . . . . .176
- Caps, Filler
  - Oil (Engine) . . . . .262
- Cargo Light . . . . .46
- Car Washes . . . . .262
- CD (Compact Disc) Player . . .102, 118
- Change Oil Indicator . . . . .214
- Charging System Light . . . . .212
- Check Engine Light (Malfunction Indicator Light) . . . . .212
- Child Restraint . . . . .22
- Child Restraints . . . . .21
  - Lower Anchors And Tethers For Children . . . . .22
- Child Seat Installation . . . . .21
- Cleaning
  - Wheels . . . . .262
  - Windshield Wiper Blades . . . .262



- Climate Control . . . . .61, 62, 64, 135
- Clock . . . . .100
- Cluster Warning/Indicator Lights
  - Air Bag Warning Light . . . . .213
  - Brake Warning Light . . . . .211
  - Front Fog Light Indicator . . . . .215
  - Fuel Cap/Loose Gas Cap . . . . .216
  - High Beam Indicator . . . . .215
  - Park/Headlight ON Indicator . . . . .215
  - Turn Signal Indicator . . . . .215
  - Vehicle Security Light . . . . .215
- Clutch . . . . .262
- Clutch Fluid . . . . .262
- Compact Spare Tire . . . . .286
- Compass Calibration . . . . .156
- Cooling System . . . . .262
  - Adding Coolant (Antifreeze) . . . . .262
  - Coolant Capacity . . . . .254, 257, 259
  - Coolant Level . . . . .262
  - Disposal Of Used Coolant . . . . .262
  - Drain, Flush, And Refill . . . . .262
  - Inspection . . . . .262
  - Points To Remember . . . . .262
  - Pressure Cap . . . . .262
  - Selection Of Coolant (Antifreeze) . . . . .254, 255, 257, 260, 262
- Corrosion Protection . . . . .262
- Customer Assistance . . . . .289, 290
- Customer Programmable Features . . . . .157
- DEF (Diesel Exhaust Fluid) . . . . .191, 204
- Defects, Reporting . . . . .290
- Defroster, Rear Window . . . . .61, 62
- Defroster, Windshield . . . . .61, 62
- Diesel Engine Maintenance . . . . .187, 199
- Diesel Exhaust Fluid (DEF) . . . . .191, 204
- Diesel Fuel Water Separator . . . . .187, 199
- Dimmer Control . . . . .45
- Disabled Vehicle Towing . . . . .209
- Disarming, Security System . . . . .16
- Disposal
  - Antifreeze (Engine Coolant) . . . . .262
- Disturb . . . . .150
- E-85 Fuel . . . . .256
- Electronic Range Select (ERS) . . . . .50, 51
- Electronics . . . . .5
  - Your Vehicle's Sound System . . . . .72
- Electronic Speed Control (Cruise Control) . . . . .46
- Electronic Stability Control (ESC) . . . . .209
- Electronic Throttle Control Warning Light . . . . .213
- Electronic Vehicle Information Center (EVIC) . . . . .67, 155
- Emergency, In Case Of
  - Freeing Vehicle When Stuck . . . . .238
  - Jump Starting . . . . .230
  - Tow Hooks . . . . .233
  - Towing . . . . .209, 238
- Engine
  - Air Cleaner . . . . .262
  - Block Heater . . . . .195
  - Break-In Recommendations . . . . .43, 185, 195
  - Checking Oil Level . . . . .262
  - Coolant (Antifreeze) . . . . .255, 257, 260
  - Cooling . . . . .262
  - Fuel Requirements . . . . .254
  - Jump Starting . . . . .230
  - Malfunction Indicator (Check Engine) . . . . .212
  - Oil . . . . .254, 255, 257, 260, 262
  - Oil Filler Cap . . . . .262
  - Oil Selection . . . . .254, 262
  - Overheating . . . . .216
  - Starting . . . . .14
  - Stopping . . . . .14
- Enhanced Accident Response Feature . . . . .240
- Ethanol . . . . .256
- Exhaust Brake . . . . .197
- Exhaust Regeneration . . . . .188
- Exhaust System . . . . .262
- Filters
  - Air Cleaner . . . . .262
  - Engine Fuel . . . . .187, 199
  - Engine Oil . . . . .255, 257, 260, 262
  - Engine Oil Disposal . . . . .262
- Flashers
  - Turn Signal . . . . .215
- Flat Tire Stowage . . . . .228
- Flexible Fuel Vehicles . . . . .256
- Fluid, Brake . . . . .256, 259

# INDEX

- Fluid Capacities . . . . .254, 257, 259
- Fluids, Lubricants And Genuine
  - Parts . . . . .255, 257, 260
- Fog Lights . . . . .45, 215
- Four Wheel Drive . . . . .166
- Four Wheel Drive Operation . . . . .166
- Freeing A Stuck Vehicle . . . . .238
- Fuel
  - Diesel . . . . .257, 260
  - Ethanol . . . . .256
  - Filler Cap (Gas Cap) . . . . .216
  - Octane Rating . . . . .255
  - Requirements . . . . .254
  - Tank Capacity . . . . .254, 257, 259
- Fuel, Flexible . . . . .256
- Fuses . . . . .281
  
- Garage Door Opener (HomeLink) . .159
- Gear Select Lever Override . . . . .234
- General Maintenance . . . . .262
- Glass Cleaning . . . . .262
  
- Hands-Free Phone (Uconnect) . . .144
- Headlight . . . . .45
- Headlights
  - Automatic . . . . .45
  - Cleaning . . . . .262
  - Dimmer Switch . . . . .45
  - High Beam . . . . .44
  - Switch . . . . .45
- Head Restraints . . . . .29
- Heated Seats . . . . .37
- Heater, Engine Block . . . . .195
- High Beam Indicator . . . . .215
- High Beam/Low Beam Select (Dimmer)
  - Switch . . . . .44
- HomeLink (Garage Door Opener) . .159
- Hood Release . . . . .241
- Hub Caps . . . . .226
  
- Idle Up Feature . . . . .198
- Installing A Child Restraint With
  - ALR . . . . .24
- Installing Child Restraints Using The
  - LATCH Lower Anchorages . . . . .23
- Instrument Cluster Indicator Lights .215
- Instrument Panel Cover . . . . .262
- Instrument Panel Lens Cleaning . .262
  
- Integrated Trailer Brake Controls . .177
- Interior And Instrument Lights . . .7, 72
- Interior Appearance Care . . . . .262
- Intermittent Wipers (Delay Wipers) . .44
- Introduction . . . . .3
  - Aftermarket Electronics . . . . .5
  - Canada . . . . .4
- In Vehicle Features
  - Uconnect Access . . . . .84
- Inverter Outlet (115V) . . . . .162
- Inverter, Power . . . . .162
- iPod/USB/MP3 Control
  - Bluetooth Streaming Audio . . .144
  
- Jack Location . . . . .217
- Jump Starting . . . . .230
  
- Key Fob . . . . .10
  - Arm The Alarm . . . . .15
  - Disarm The Alarm . . . . .16
- Keyless Enter-N-Go . . . . .13
  - Automatic Trans . . . . .14
  - Engine Stopping . . . . .14
  - Lock/Unlock . . . . .13
  - Starting/Stopping . . . . .14
  
- Lane Change And Turn Signals . . . .44
- Lane Change Assist . . . . .44
- Lap/Shoulder Belts . . . . .16
- Left Switch
  - Steering Wheel Audio Controls .155
- Light Bulbs . . . . .288
- Lights
  - Air Bag . . . . .20
  - Cargo . . . . .46
  - Engine Temperature Warning . .210
  - Fog . . . . .215
  - High Beam Indicator . . . . .215
  - Security Alarm . . . . .215
  - Service . . . . .288
  - Turn Signal . . . . .44
- Lower Anchors And Tether For Children (LATCH) . . . . .22
- Lubrication, Body . . . . .262
  
- Maintenance Free Battery . . . . .262
- Maintenance, General . . . . .262
- Maintenance Procedures . . . . .262

- Maintenance Record . . .266, 272, 279
- Maintenance
  - Schedule . . . .262, 267, 273, 275
- Malfunction Indicator Light (Check Engine) . . . . .212
- Manual Transmission
  - Lubricant Selection . . . . .256
- Master Cylinder (Brakes) . . . . .262
- Media Center Radio . . . . .108
- Media Hub . . . . .129
- Memory Seat . . . . .33
- Message Center
  - Water In Fuel . . . . .186, 196
- Mirrors
  - Memory . . . . .33
- MOPAR Accessories . . . . .291
- Navigation . . . . .121, 124, 136
- Navigation System (Uconnect GPS) .67
- New Vehicle Break-In
  - Period . . . . .43, 185, 195
- Oil Change Indicator . . . . .214, 274
- Oil Change Indicator, Reset . . . . .214
- Oil, Engine . . . . .255, 257, 260, 262
  - Capacity . . . . .254, 257, 259
  - Change Interval . . . . .262
  - Checking . . . . .262
  - Disposal . . . . .262
  - Filter . . . . .255, 257, 260, 262
  - Filter Disposal . . . . .262
  - Materials Added To . . . . .262
  - Recommendation . . . . .254, 262
  - Viscosity . . . . .254, 262
- Oil Filter, Selection . . . . .262
- Outlet
  - Power . . . . .163
- Overheating, Engine . . . . .216
- Paint Care . . . . .262
- Panic Alarm . . . . .11
- ParkSense System, Rear . . . . .66
- Payload Capacity . . . . .176
- Pedals, Adjustable . . . . .41
- Perform Service Indicator, Reset . .274
- Personalized Menu Bar . . . . .113
- Phone, Hands-Free (Uconnect) . . .144
- Phone (Pairing) . . . . .126, 146
- Phone (Uconnect) . . . . .109, 130, 144
- Pickup Box . . . . .169, 170
- Placard, Tire And Loading Information . . . . .285
- Power
  - Distribution Center (Fuses) . . .281
  - Glass Sunroof . . . . .69
  - Inverter . . . . .162
  - Outlet (Auxiliary Electrical Outlet) . . . . .163
  - Seats . . . . .31
  - Sliding Rear Window . . . . .69
- Power Seats
  - Down . . . . .31
  - Forward . . . . .31
  - Rearward . . . . .31
  - Recline . . . . .32
  - Tilt . . . . .31
  - Up . . . . .31
- Power Steering Fluid . . . . .256
- Preparation For Jacking . . . . .219
- Programmable Electronic Features .156
- Purchase Apps
  - Uconnect Access . . . . .81, 139
- Radio . . . . .99, 107, 128
  - Balance and Fade . . . . .100
  - Equalizer . . . . .100
  - Operation . . . . .101
  - Presets . . . . .91, 93, 114
  - Setting the Clock . . . . .100
- Radio 3.0 . . . . .90
- Radio Screens . . . . .111
- Radio (Sound Systems) . . . . .99, 107
- Rain Sensitive Wiper System . . . . .44
- Rear Heated Seats . . . . .38
- Rear ParkSense System . . . . .66
- Recreational Towing . . . . .179
  - Shifting Into Transfer Case
    - Neutral (N) . . . . .182
  - Shifting Out Of Transfer Case
    - Neutral (N) . . . . .183
- Refrigerant . . . . .262
- Remote Keyless Entry (RKE)
  - Arm The Alarm . . . . .15
  - Disarm The Alarm . . . . .16
- Remote Starting System . . . . .15
- Replacement Bulbs . . . . .288

# INDEX

- Reporting Safety Defects . . . . .290
- Resetting Perform Service Indicator.274
- Restraint, Head . . . . .29
  
- Schedule, Maintenance . . . .262, 267
- SD Card Port . . . . .103, 118
- Seat Belt
  - Seat Belt Pretensioner . . . . .16
- Seat Belt Maintenance . . . . .262
- Seat Belts . . . . .16
  - Adjustable Shoulder Belt . . . . .16
  - Pretensioners . . . . .16
- Seats . . . . .31
  - Adjustment . . . . .31
  - Easy Entry . . . . .35
  - Heated . . . . .37
  - Memory . . . . .33
  - Power . . . . .31
- Security Alarm . . . . .215
  - Arm The System . . . . .15
  - Disarm The System . . . . .16
  - Security Alarm . . . . .15
- Selection Of Coolant
  - (Antifreeze) . . . . .255, 257, 260
- Shifting
  - Transfer Case, Shifting Into
  - Transfer Case Neutral (N) . . . .182
  - Transfer Case, Shifting Out Of
  - Transfer Case Neutral (N) . . . .183
- Shift Lever Override . . . . .234
- Signals, Turn . . . . .44, 215
- Siri . . . . .131, 132
- Sirius Satellite Radio . . . .102, 115
  - Traffic & Weather . . . . .124
- SIRIUS Travel Link . . . . .124
- Sound Systems (Radio) . .99, 118, 121
- Spare Tire . . . . .286, 287
- Spark Plugs . . . . .255
- Speed Control
  - Accel/Decel . . . . .48
  - Cancel . . . . .47
  - Resume . . . . .47
- Speed Control (Cruise Control) . . .46
- Starting
  - Cold Weather . . . . .186, 196
  - Remote . . . . .15
- Starting Procedures (Diesel Engines) . . . . .185, 195
  
- Steering
  - Wheel, Heated . . . . .39
  - Wheel, Tilt . . . . .40
- Steering Wheel Mounted Sound
  - System Controls . . . . .155
- Sunroof
  - Closing . . . . .70
  - Opening . . . . .69
  - Venting . . . . .70
- Sun Roof . . . . .69
- Supplemental Restraint System - Air Bag . . . . .17
  
- Tailgate . . . . .169
- Temperature Control, Automatic (ATC) . . . . .64
- Tether Anchor, Child Restraint . . .24
- Text Messaging . .110, 134, 140, 151, 152
  
- Tilt
  - Down . . . . .31
  - Up . . . . .31
- Tilt Steering Column . . . . .40
- Tires . . . . .285, 286
  - Air Pressure . . . . .285
  - Changing . . . . .219
  - Compact Spare . . . . .286
  - Flat Changing . . . . .219
  - General Information . . . .285, 286
  - Jacking . . . . .219
  - Pressure Warning Light . . . . .209
  - Spare Tire . . . . .286, 287
- Tow/Haul . . . . .176
- Tow Hooks, Emergency . . . . .233
- Towing
  - Capacity . . . . .176
  - Disabled Vehicle . . . . .238
  - Recreational . . . . .179
- Towing Vehicle Behind A
  - Motorhome . . . . .179
- Traction Control . . . . .212
- Trailer Towing
  - Trailer And Tongue Weight . . .176
- Transfer Case
  - Fluid . . . . .256, 259, 261
- Transmission
  - Fluid . . . . .256, 259, 261, 262
  - Maintenance . . . . .262

- Warning Light . . . . .214
- Turbo Cool Down . . . . .189, 203
- Turn Signals . . . . .44, 215
- Uconnect
  - Access . . . . .77, 79, 83
  - Account . . . . .79, 83, 87
  - Maintaining Your Account . . . . .83
  - Registration . . . . .79, 138
  - Remote Features . . . . .87
  - Using Access . . . . .82
  - Via Mobile Apps . . . . .81
- Uconnect 3.0 . . . . .92
- Uconnect 5.0 . . . . .99
- Uconnect 8.4A . . . . .111, 137
  - Helpful Tips For Bluetooth . . . . .154
  - Mute . . . . .149
  - Phonebook . . . . .149
  - Transfer Ongoing Call Between
    - Handset And Vehicle . . . . .149
    - Voice Recognition Tips . . . . .150
- Uconnect 8.4A/8.4AN Voice
  - Recognition
    - SiriusXM Travel Link . . . . .142
    - Voice Texting . . . . .150
- Uconnect 8.4AN . . . . .111, 137
- Uconnect Access. . . . .77, 137
  - APP . . . . .80
  - In Vehicle Features . . . . .84
  - Purchase Apps . . . . .81, 139
  - Yelp . . . . .141
- Uconnect (Hands-Free Phone)
  - Making A Phone Call . . . . .144, 150
  - Receiving A Call . . . . .144
- Uconnect Phone. .126, 144, 149, 151
- Uconnect Voice
  - Command .95, 104, 105, 106, 107, 108, 109, 110, 125, 149
- USB Port . . . . .103, 118
- Using Access
  - Uconnect . . . . .82
- Using The Top Tether Anchorage . . .25
- Vehicle Security Alarm Disarming . .16
- Via Mobile Apps
  - Uconnect . . . . .81
- Voice Command . .95, 104, 105, 106, 107, 108, 109, 110, 125, 127, 149
- Voice Recognition System
  - (VR) .95, 104, 105, 106, 107, 108, 109, 110, 125, 149, 150
- Washer
  - Adding Fluid . . . . .262
- Washers, Windshield . . . . .44
- Washing Vehicle. . . . .262
- Water in Fuel . . .186, 187, 196, 199
- Water Separator, Diesel Fuel .187, 199
- Water Separator Draining . . .187, 199
- Wheel And Wheel Trim . . . . .262
- Wheel And Wheel Trim Care. .262, 287
- Wheel Cover . . . . .226
- Wheel Nut Torque. . . . .227
- Wind Buffeting . . . . .71
- Windshield Washers . . . . .44
- Windshield Wiper Blades . . . . .262
- Windshield Wipers . . . . .44
- Wiper Blade Replacement . . . . .262













This guide has been prepared to help you get quickly acquainted with your new Ram brand vehicle and to provide a convenient reference source for common questions. However, it is not a substitute for your Owner's Manual.

For complete operational instructions, maintenance procedures and important safety messages, please consult your Owner's Manual, Navigation/Uconnect Manuals and other Warning Labels in your vehicle.

Not all features shown in this guide may apply to your vehicle. For additional information on accessories to help personalize your vehicle, visit [www.mopar.com](http://www.mopar.com) (U.S.), [www.mopar.ca](http://www.mopar.ca) (Canada) or your local Ram brand dealer.

## **DRIVING AND ALCOHOL**

Drunken driving is one of the most frequent causes of collisions. Your driving ability can be seriously impaired with blood alcohol levels far below the legal minimum. If you are drinking, don't drive. Ride with a designated non-drinking driver, call a cab, a friend, or use public transportation.

### **WARNING**

Driving after drinking can lead to a collision. Your perceptions are less sharp, your reflexes are slower, and your judgment is impaired when you have been drinking. Never drink and then drive.

Download a FREE electronic copy of the Owner's Manual and Warranty Booklet by visiting:

[WWW.RAMTRUCKS.COM/EN/OWNERS/MANUALS](http://WWW.RAMTRUCKS.COM/EN/OWNERS/MANUALS) OR

[WWW.RAMTRUCKS.COM/EN/WARRANTY](http://WWW.RAMTRUCKS.COM/EN/WARRANTY) (U.S.);

[WWW.OWNERS.MOPAR.CA/EN](http://WWW.OWNERS.MOPAR.CA/EN) (CANADA).



© 2015 FCA US LLC. ALL RIGHTS RESERVED. RAM IS A REGISTERED TRADEMARK OF FCA US LLC.



16D241-926-AA  
RAM TRUCKS 1500/2500/3500  
SECOND EDITION REV. 1  
USER GUIDE