

VIPER
USER
GUIDE



DODGE 

If you are the first registered retail owner of your vehicle, you may obtain a complimentary printed copy of the Owner's Manual, Navigation/Uconnect Manuals or Warranty Booklets by calling 1-800-423-6343 (U.S.) or 1-800-387-1143 (Canada) or by contacting your dealer.

IMPORTANT

This User Guide is intended to familiarize you with the important features of your vehicle. Your Owner's Manual, Navigation/Uconnect Manuals, Warranty Booklets and Tire Warranty can be found on your DVD (if applicable) or by visiting the website on the back cover of your User Guide. We hope you find it useful. U.S. residents can purchase replacement kits by visiting www.techauthority.com and Canadian residents can purchase replacement kits by calling 1-800-387-1143.

The driver's primary responsibility is the safe operation of the vehicle. Driving while distracted can result in loss of vehicle control, resulting in a collision and personal injury. FCA US LLC strongly recommends that the driver use extreme caution when using any device or feature that may take their attention off the road. Use of any electrical devices, such as cellular telephones, computers, portable radios, vehicle navigation or other devices, by the driver

while the vehicle is moving is dangerous and could lead to a serious collision. Texting while driving is also dangerous and should never be done while the vehicle is moving. If you find yourself unable to devote your full attention to vehicle operation, pull off the road to a safe location and stop your vehicle. Some states or provinces prohibit the use of cellular telephones or texting while driving. It is always the driver's responsibility to comply with all local laws.



TABLE OF CONTENTS

INTRODUCTION/WELCOME

WELCOME FROM FCA US LLC	2
-------------------------	---

CONTROLS AT A GLANCE

DRIVER COCKPIT	4
INSTRUMENT CLUSTER	6

GETTING STARTED

KEY FOB	8
ENGINE STARTING/STOPPING	9
VEHICLE SECURITY ALARM	10
DOOR LOCKS	11
WINDOWS	13
OCCUPANT RESTRAINT SYSTEMS	13
NON-ADJUSTABLE HEAD RESTRAINTS	45
FRONT SEATS	46
ADJUSTABLE PEDALS	48
ADJUSTABLE FOOT REST	49
TILT STEERING COLUMN	49

OPERATING YOUR VEHICLE

SRT ENGINE BREAK-IN RECOMMENDATIONS	50
TURN SIGNALS/WIPER/WASHER/HIGH BEAMS LEVER	51
HEADLIGHT SWITCH	52
ELECTRONIC SPEED CONTROL	53
LAUNCH MODE	56
ELECTRONIC CONTROL DAMPING SYSTEM	57
ELECTRONIC STABILITY CONTROL (ESC)	58
MANUAL TRANSMISSION 1 TO 4 SKIP SHIFT	59
AUTOMATIC TEMPERATURE CONTROL (ATC)	60
PARKVIEW REAR BACK UP CAMERA	62

ELECTRONICS

YOUR VEHICLE'S SOUND SYSTEM	64
CYBERSECURITY	66
YOUR RADIO	67
UCONNECT ACCESS	67
UCONNECT 8.4 NAV	79
UCONNECT 8.4 NAV VOICE RECOGNITION QUICK TIPS	92
UCONNECT PHONE	111
STEERING WHEEL AUDIO CONTROLS	120
INSTRUMENT CLUSTER DISPLAY	121
PERFORMANCE PAGES	123
PROGRAMMABLE FEATURES	124
UNIVERSAL GARAGE DOOR OPENER (HomeLink)	125
POWER OUTLETS	128

UTILITY

TRAILER TOWING WEIGHTS (MAXIMUM TRAILER WEIGHT RATINGS)	129
RECREATIONAL TOWING (BEHIND MOTORHOME, ETC.)	129

WHAT TO DO IN EMERGENCIES

ROADSIDE ASSISTANCE	130
WARNING AND INDICATOR LIGHTS	130
IF YOUR ENGINE OVERHEATS	136
TIRE SERVICE KIT	136
JUMP-STARTING PROCEDURES	142
TOWING A DISABLED VEHICLE	144
FREEDING A STUCK VEHICLE	145
ENHANCED ACCIDENT RESPONSE SYSTEM (EARS)	145
EVENT DATA RECORDER (EDR)	146

MAINTAINING YOUR VEHICLE

TO OPEN AND CLOSE THE HOOD	147
ENGINE COMPARTMENT — 8.4L	148
FLUID CAPACITIES	150
FLUIDS, LUBRICANTS, AND GENUINE PARTS	150
ADDING FUEL	152
MAINTENANCE PROCEDURES	153
MAINTENANCE SCHEDULES	153
FUSES	158
TIRE SAFETY INFORMATION	161
TIRES — GENERAL INFORMATION	167
DEPARTMENT OF TRANSPORTATION UNIFORM TIRE QUALITY GRADES	171
REPLACEMENT BULBS	172

CONSUMER ASSISTANCE

FCA US LLC CUSTOMER CENTER	173
FCA CANADA INC. CUSTOMER CENTER	173
ASSISTANCE FOR THE HEARING IMPAIRED	173
PUBLICATIONS ORDERING	173
REPORTING SAFETY DEFECTS IN THE UNITED STATES	174

MOPAR® ACCESSORIES

AUTHENTIC ACCESSORIES BY MOPAR	175
--------------------------------	-----

FREQUENTLY ASKED QUESTIONS

FREQUENTLY ASKED QUESTIONS	176
----------------------------	-----

INDEX	177
-------	-----



INTRODUCTION/WELCOME

WELCOME FROM FCA US LLC

Congratulations on selecting your new FCA US LLC (“FCA US”) vehicle. Be assured that it represents precision workmanship, distinctive styling, and high quality.

Your new FCA US vehicle has characteristics to enhance the driver's control under some driving conditions. These are to assist the driver and are never a substitute for attentive driving. They can never take the driver's place. Always drive carefully.

Your new vehicle has many features for the comfort and convenience of you and your passengers. Some of these should not be used when driving because they take your eyes from the road or your attention from driving. Never text while driving or take your eyes, more than momentarily, off the road.

This guide illustrates and describes the operation of features and equipment that are either standard or optional on this vehicle. This guide may also include a description of features and equipment that are no longer available or were not ordered on this vehicle. Please disregard any features and equipment described in this guide that are not available on this vehicle. FCA US reserves the right to make changes in design and specifications and/or make additions to or improvements to its products without imposing any obligation upon itself to install them on products previously manufactured.

This User Guide has been prepared to help you quickly become acquainted with the important features of your vehicle. It contains most things you will need to operate and maintain the vehicle, including emergency information.

The DVD includes a computer application containing detailed Owner's information which can be viewed on a personal computer or MAC computer. The multimedia DVD also includes videos which can be played on any standard DVD player (including the Uconnect Touchscreen Radios if equipped with DVD player capabilities). Additional DVD operational information is located on the back of the DVD sleeve.

For complete owner information, refer to your Owner's Manual on the DVD in the owner's kit provided at the time of new vehicle purchase. For your convenience, the information contained on the DVD may also be printed and saved for future reference.

FCA US is committed to protecting our environment and natural resources. By converting from paper to electronic delivery for the majority of the user information for your vehicle, together we greatly reduce the demand for tree-based products and lessen the stress on our environment.

INTRODUCTION/WELCOME

VEHICLES SOLD IN CANADA

With respect to any vehicles sold in Canada, the name FCA US LLC shall be deemed to be deleted and the name FCA Canada Inc. used in substitution (excluding legal lines).

WARNING!

- Pedals that cannot move freely can cause loss of vehicle control and increase the risk of serious personal injury.
- Always make sure that objects cannot fall into the driver foot well while the vehicle is moving. Objects can become trapped under the brake pedal and accelerator pedal causing a loss of vehicle control.
- Failure to properly follow floor mat installation or mounting can cause interference with the brake pedal and accelerator pedal operation causing loss of control of the vehicle.
- Never leave children alone in a vehicle, or with access to an unlocked vehicle. Allowing children to be in a vehicle unattended is dangerous for a number of reasons. A child or others could be seriously or fatally injured. Children should be warned not to touch the parking brake, brake pedal or the transmission gear selector.
- Do not leave the key fob in or near the vehicle, or in a location accessible to children. A child could operate power windows, other controls, or move the vehicle.
- Never use the 'PARK' position as a substitute for the parking brake. Always apply the parking brake fully when parked to guard against vehicle movement and possible injury or damage.
- Refer to your Owner's Manual on the DVD for further details.

USE OF AFTERMARKET PRODUCTS (ELECTRONICS)

The use of aftermarket devices including cell phones, MP3 players, GPS systems, or chargers may affect the performance of on-board wireless features including Keyless Enter-N-Go and Remote Start range. If you are experiencing difficulties with any of your wireless features, try disconnecting your aftermarket devices to see if the situation improves. If your symptoms persist, please see an authorized dealer.

When it comes to service, remember that your authorized dealer knows your vehicle best, has factory-trained technicians and genuine MOPAR® parts, and cares about your satisfaction.



CONTROLS AT A GLANCE

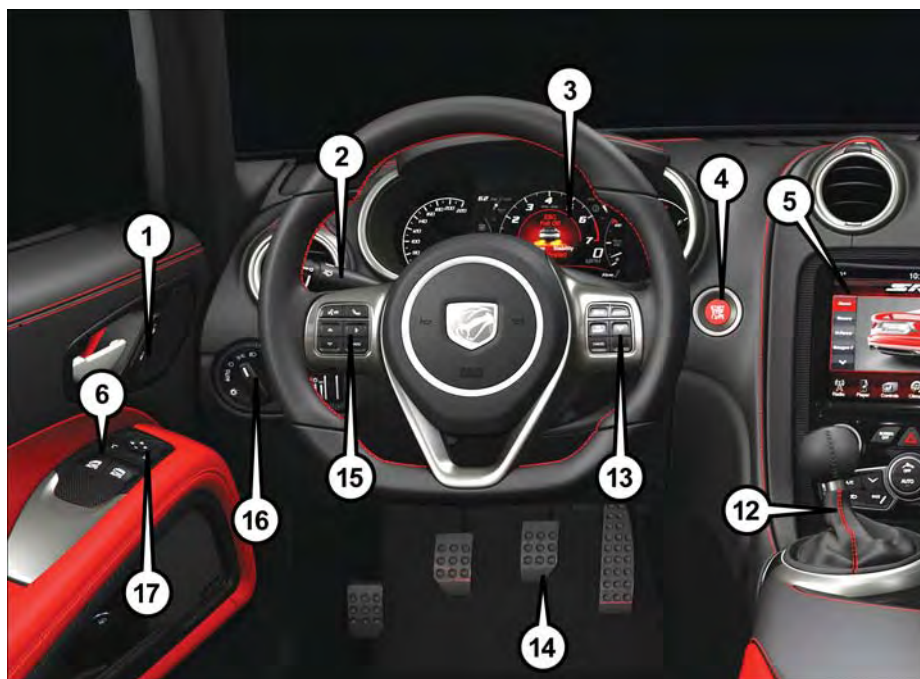

DRIVER COCKPIT

1. Power Door Locks
2. Turn Signal/Wiper/Washer/High Beams Lever (behind steering wheel) pg. 51
3. Instrument Cluster
4. Ignition Start/Stop Button (behind steering wheel) pg. 9
5. Identifying Your Radio pg. 67
6. Power Window Switches
7. Glove Compartment
8. Glove Compartment Switch
9. Hazard Button

CONTROLS AT A GLANCE

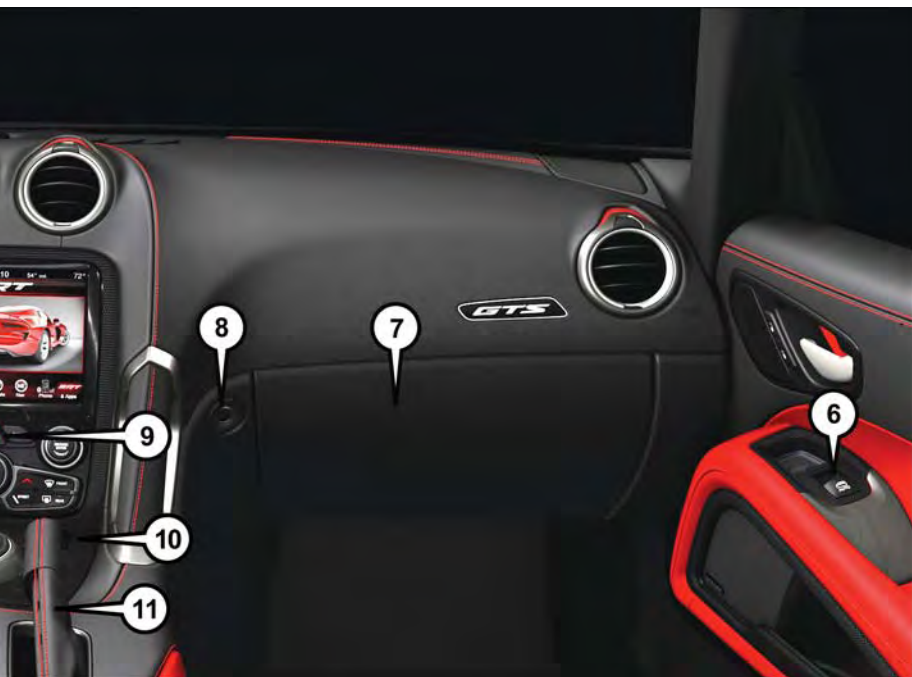

- 10. Power Outlet pg. 128
- 11. Emergency Brake
- 12. Gear Selector
- 13. Electronic Speed Control pg. 53
- 14. Adjustable Pedals pg. 48
- 15. Instrument Cluster Display Controls pg. 121
- 16. Headlight Switch pg. 52
- 17. Power Mirrors

CONTROLS AT A GLANCE



INSTRUMENT CLUSTER

1. Speedometer
2. Tachometer
3. Instrument Cluster Display

(See page 130 for Instrument Cluster Warning Lights information.)

CONTROLS AT A GLANCE



- 4. Oil Pressure Gauge
- 5. Fuel Gauge
- 6. Fuel Filler Door Location

(See page 135 for Instrument Cluster Indicator Lights information.)

GETTING STARTED

KEY FOB

Locking And Unlocking The Doors

Locking The Doors

Push the lock button once to lock all the doors. The turn signal lights will flash, and the horn will chirp to acknowledge the signal.

Unlocking The Doors

Push the lock button once to unlock the driver's door only and twice within five seconds to unlock all the doors.

NOTE:

The Door Unlock Indicator  will illuminate in the instrument cluster when one or both doors are unlocked. When the doors are locked, the indicator will not illuminate.

Opening The Liftgate

Push the liftgate button two times within five seconds to open the liftgate.

Panic Alarm

1. Push the PANIC button once to turn the Panic Alarm on.
2. Wait approximately three seconds and push the button a second time to turn the Panic Alarm off.



Key Fob

- 1 — Liftgate
- 2 — Unlock
- 3 — Lock
- 4 — Panic

WARNING!

- When leaving the vehicle, always make sure the keyless ignition node is in "OFF" mode, remove the key fob from the vehicle and lock the vehicle.
- Never leave children alone in a vehicle, or with access to an unlocked vehicle. Leaving children in a vehicle unattended is dangerous for a number of reasons. A child or others could be seriously or fatally injured. Children should be warned not to touch the parking brake, brake pedal or the transmission gear selector.
- Do not leave the key fob in or near the vehicle (or in a location accessible to children), and do not leave the ignition (of a vehicle equipped with Keyless Enter-N-Go) in the ACC or ON/RUN mode. A child could operate power windows, other controls, or move the vehicle.
- Do not leave children or animals inside parked vehicles in hot weather. Interior heat build-up may cause serious injury or death.

Emergency Key

Should the battery in the vehicle or the key fob go dead, there is an emergency key located in the key fob.

- To remove the emergency key, slide the button at the back of the key fob sideways with your thumb and then pull the key out with your other hand.
- The Key Cylinder is located in the rear applique to the right of the license plate.

NOTE:

In the event that the key fob does not start the vehicle ("FOB not Found" message), use the key fob nose (furthest point from key ring) and push the start button. The key fob replaces the finger.

WARNING!

- Always apply the parking brake fully when parked to guard against vehicle movement and possible injury or damage.
- Never leave children alone in a vehicle, or with access to an unlocked vehicle. Allowing children to be in a vehicle unattended is dangerous for a number of reasons. A child or others could be seriously or fatally injured. Children should be warned not to touch the parking brake, brake pedal or the transmission gear selector.
- Do not leave the key fob in or near the vehicle, or in a location accessible to children, and do not leave the ignition of a vehicle equipped with Keyless Enter-N-Go in the ACC or ON/RUN mode. A child could operate power windows, other controls, or move the vehicle

ENGINE STARTING/STOPPING

Starting

1. Fully apply the parking brake.
2. Push the clutch pedal to the floor.
3. Place the gear selector in NEUTRAL.
4. Push the red ENGINE START/STOP button located on the instrument panel. Release the button when the engine starts.

NOTE:

The engine will not start unless the clutch pedal is pushed to the floor.

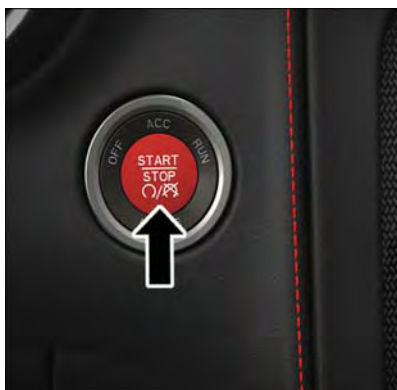

Start/Stop Button

GETTING STARTED

Stopping

1. Bring the vehicle to a complete stop.
2. Fully apply the parking brake.
3. Push the clutch pedal to the floor.
4. Place the gear selector in 1st Gear.
5. Push the ENGINE START/STOP button once. The ignition switch will return to the OFF position.

VEHICLE SECURITY ALARM

The Vehicle Security Alarm monitors the vehicle doors for unauthorized entry and the ignition for unauthorized operation. While the Vehicle Security Alarm is armed, interior switches for door locks and liftgate are disabled. If something triggers the alarm, the Vehicle Security Alarm will provide the following audible and visible signals: the horn will pulse, the park lamps and/or turn signals will flash, and the Vehicle Security Light in the instrument cluster display will flash.

To Arm:

These steps will arm the Vehicle Security Alarm:

- Push the lock button on the interior power door lock switch with the driver and/or passenger door open or;
- Push the lock button on the Remote Keyless Entry key fob.
- The Vehicle Security Light in the instrument cluster will flash for 16 seconds. This shows that the Vehicle Security Alarm is arming. During this period, if a door is opened, the ignition is cycled to ON/RUN, or the power door locks are unlocked in any manner, the Vehicle Security Alarm will automatically disarm.

NOTE:

- During the 16-second arming period, if a door is opened or the ignition is cycled to ON/RUN, the Vehicle Security Alarm will automatically disarm.
- Once armed, the Vehicle Security Alarm disables the unlock switch on the driver door trim panel and passenger door trim panel.
- Using the key to open the liftgate while the Vehicle Security Alarm is armed will not trigger the theft alarm.

To Disarm:

The Vehicle Security Alarm can be disarmed using any of the following methods:

- Push the unlock button on the Remote Keyless Entry key fob.
- Cycle the vehicle ignition system out of the OFF position.

DOOR LOCKS

WARNING!

- Do not touch the exhaust pipe sill covers when entering or exiting your vehicle. They can be hot enough to burn you. Observe the warning labels on each door closure panel.
- Before exiting a vehicle, always shift the transmission into NEUTRAL, apply the parking brake, turn the engine OFF, remove the key fob from the ignition and lock your vehicle. If equipped with Keyless Enter-N-Go, always make sure the keyless ignition node is in “OFF” mode, remove the key fob from the vehicle and lock the vehicle.
- When leaving the vehicle, always cycle the ignition to the OFF mode lock, and lock your vehicle. Unsupervised use of vehicle equipment may cause severe personal injuries and death.
- Never leave children alone in a vehicle. Leaving unattended children in a vehicle is dangerous for a number of reasons. A child or others could be injured seriously or fatally. Don't leave the ignition in the ACC or ON/RUN mode. A child could operate power windows, other controls, or move the vehicle.

GETTING STARTED

Power Door Locks

A power door lock switch is on each door trim panel. Use this switch to lock or unlock the doors.

WARNING!

- For personal security and safety in the event of a collision, lock the vehicle doors before you drive as well as when you park and leave the vehicle.
- Never leave children alone in a vehicle, or with access to an unlocked vehicle. Allowing children to be in a vehicle unattended is dangerous for a number of reasons. A child or others could be seriously or fatally injured. Children should be warned not to touch the parking brake, brake pedal or the gear selector.
- Do not leave the key fob in or near the vehicle, or in a location accessible to children. A child could operate power windows, other controls, or move the vehicle.

If you push the power door lock switch while the ignition is in the ACC or ON/RUN position, and any front door is open, the power locks will not operate. This prevents you from accidentally locking the key fob in the vehicle. Cycling the ignition to the OFF position or closing the door will allow the locks to operate. If a door is open, and the ignition is in the ACC or ON/RUN position, a chime will sound as a reminder to remove the key fob.

NOTE:

The door unlock indicator will illuminate in the instrument cluster when one or both doors are unlocked.



Power Door Lock Switch

WINDOWS

Power Windows

The window controls on the driver's door control both of the door windows.

There are single window controls on the passenger door trim panel, which operate the passenger door window. The window controls will operate only when the ignition is in the ACC or ON/RUN position.

The power window switches will remain active for up to 10 minutes after the ignition is cycled to the OFF position. Opening either front door will cancel this feature. The time is programmable. Refer to "Uconnect Settings" in "Understanding Your Instrument Panel" for further information.



Power Window Switches

WARNING!

Never leave children unattended in a vehicle, and do not let children play with power windows. Do not leave the key fob in or near the vehicle, or in a location accessible to children, and do not leave the ignition of a vehicle equipped with Keyless Enter-N-Go in the ACC or ON/RUN mode. Occupants, particularly unattended children, can become entrapped by the windows while operating the power window switches. Such entrapment may result in serious injury or death.

OCCUPANT RESTRAINT SYSTEMS

Some of the most important safety features in your vehicle are the restraint systems.

Occupant Restraint Systems Features

- Seat Belt Systems
- Supplemental Restraint Systems (SRS) Air Bags
- Child Restraints

Some of the safety features described in this section may be standard equipment on some models, or may be optional equipment on others. If you are not sure, ask your authorized dealer.

GETTING STARTED

Important Safety Precautions

Please pay close attention to the information in this section. It tells you how to use your restraint system properly, to keep you and your passengers as safe as possible.

Here are some simple steps you can take to minimize the risk of harm from a deploying air bag:

1. Children 12 years old and under should always ride buckled up in a vehicle with a rear seat.
2. If a child from 2 to 12 years old (not in a rear-facing child restraint) must ride in the front passenger seat, move the seat as far back as possible and use the proper child restraint (Refer to "Child Restraints").
3. Children that are not big enough to wear the vehicle seat belt properly (Refer to "Child Restraints") should be secured in a vehicle with a rear seat in child restraints or belt-positioning booster seats. Older children who do not use child restraints or belt-positioning booster seats should ride properly buckled up in a vehicle with a rear seat.
4. Never allow children to slide the shoulder belt behind them or under their arm.
5. You should read the instructions provided with your child restraint to make sure that you are using it properly.
6. All occupants should always wear their lap and shoulder belts properly.
7. The driver and front passenger seats should be moved back as far as practical to allow the front air bags room to inflate.
8. Do not lean against the door or window. If your vehicle has side air bags, and deployment occurs, the side air bags will inflate forcefully into the space between occupants and the door and occupants could be injured.
9. If the air bag system in this vehicle needs to be modified to accommodate a disabled person, contact the Customer Center. Phone numbers are provided under "If You Need Consumer Assistance" in your Owner's Manual on the DVD.

WARNING!

- Never place a rear-facing child restraint in front of an air bag. A deploying passenger front air bag can cause death or serious injury to a child 12 years or younger, including a child in a rear-facing child restraint.
- Only use a rear-facing child restraint in a vehicle with a rear seat.

Seat Belt Systems

Buckle up even though you are an excellent driver, even on short trips. Someone on the road may be a poor driver and could cause a collision that includes you. This can happen far away from home or on your own street.

Research has shown that seat belts save lives, and they can reduce the seriousness of injuries in a collision. Some of the worst injuries happen when people are thrown from the vehicle. Seat belts reduce the possibility of ejection and the risk of injury caused by striking the inside of the vehicle. Everyone in a motor vehicle should be belted at all times.

Enhanced Seat Belt Use Reminder System (BeltAlert)

Driver and Passenger BeltAlert (If Equipped)

 BeltAlert is a feature intended to remind the driver and outboard front seat passenger (if equipped with outboard front passenger seat BeltAlert) to buckle their seat belts. The Belt Alert feature is active whenever the ignition switch is in the START or ON/RUN position.

Initial Indication

If the driver is unbuckled when the ignition switch is first in the START or ON/RUN position, a chime will signal for a few seconds. If the driver or outboard front seat passenger (if equipped with outboard front passenger seat BeltAlert) is unbuckled when the ignition switch is first in the START or ON/RUN position the Seat Belt Reminder Light will turn on and remain on until both outboard front seat belts are buckled. The outboard front passenger seat BeltAlert is not active when an outboard front passenger seat is unoccupied.

BeltAlert Warning Sequence

The BeltAlert warning sequence is activated when the vehicle is moving above a specified vehicle speed range and the driver or outboard front seat passenger is unbuckled (if equipped with outboard front passenger seat BeltAlert) (the outboard front passenger seat BeltAlert is not active when the outboard front passenger seat is unoccupied). The BeltAlert warning sequence starts by blinking the Seat Belt Reminder Light and sounding an intermittent chime. Once the BeltAlert warning sequence has completed, the Seat Belt Reminder Light will remain on until the seat belts are buckled. The BeltAlert warning sequence may repeat based on vehicle speed until the driver and occupied outboard front seat passenger seat belts are buckled. The driver should instruct all occupants to buckle their seat belts.

Change Of Status

If the driver or outboard front seat passenger (if equipped with outboard front passenger seat BeltAlert) unbuckles their seat belt while the vehicle is traveling, the BeltAlert warning sequence will begin until the seat belts are buckled again. The outboard front passenger seat BeltAlert is not active when the outboard front passenger seat is unoccupied. BeltAlert may be triggered when an animal or other items are placed on the outboard front passenger seat or when the seat is folded flat (if equipped). It is recommended that

GETTING STARTED

pets be restrained in the rear seat (if equipped) in pet harnesses or pet carriers that are secured by seat belts, and cargo is properly stowed.

BeltAlert can be activated or deactivated by your authorized dealer. FCA US LLC does not recommend deactivating BeltAlert.

NOTE:

If BeltAlert has been deactivated and the driver or outboard front seat passenger (if equipped with outboard front passenger seat BeltAlert) is unbuckled the Seat Belt Reminder Light will turn on and remain on until the driver and outboard front seat passenger seat belts are buckled.

Lap/Shoulder Belts

All seating positions in your vehicle are equipped with lap/shoulder belts.

The seat belt webbing retractor will lock only during very sudden stops or collisions. This feature allows the shoulder part of the seat belt to move freely with you under normal conditions. However, in a collision the seat belt will lock and reduce your risk of striking the inside of the vehicle or being thrown out of the vehicle.

WARNING!

- Relying on the air bags alone could lead to more severe injuries in a collision. The air bags work with your seat belt to restrain you properly. In some collisions, the air bags won't deploy at all. Always wear your seat belt even though you have air bags.
- In a collision, you and your passengers can suffer much greater injuries if you are not properly buckled up. You can strike the interior of your vehicle or other passengers, or you can be thrown out of the vehicle. Always be sure you and others in your vehicle are buckled up properly.
- It is dangerous to ride in a cargo area, inside or outside of a vehicle. In a collision, people riding in these areas are more likely to be seriously injured or killed.
- Do not allow people to ride in any area of your vehicle that is not equipped with seats and seat belts.
- Be sure everyone in your vehicle is in a seat and using a seat belt properly. Occupants, including the driver, should always wear their seat belts whether or not an air bag is also provided at their seating position to minimize the risk of severe injury or death in the event of a crash.
- Wearing your seat belt incorrectly could make your injuries in a collision much worse. You might suffer internal injuries, or you could even slide out of the seat belt. Follow these instructions to wear your seat belt safely and to keep your passengers safe, too.
- Two people should never be belted into a single seat belt. People belted together can crash into one another in a collision, hurting one another badly. Never use a lap/shoulder belt or a lap belt for more than one person, no matter what their size.
- A lap belt worn too high can increase the risk of injury in a collision. The seat belt forces won't be at the strong hip and pelvic bones, but across your abdomen. Always wear the lap part of your seat belt as low as possible and keep it snug.

WARNING!

- A twisted seat belt may not protect you properly. In a collision, it could even cut into you. Be sure the seat belt is flat against your body, without twists. If you can't straighten a seat belt in your vehicle, take it to your authorized dealer immediately and have it fixed.
- A seat belt that is buckled into the wrong buckle will not protect you properly. The lap portion could ride too high on your body, possibly causing internal injuries. Always buckle your seat belt into the buckle nearest you.
- A seat belt that is too loose will not protect you properly. In a sudden stop, you could move too far forward, increasing the possibility of injury. Wear your seat belt snugly.
- A seat belt that is worn under your arm is dangerous. Your body could strike the inside surfaces of the vehicle in a collision, increasing head and neck injury. A seat belt worn under the arm can cause internal injuries. Ribs aren't as strong as shoulder bones. Wear the seat belt over your shoulder so that your strongest bones will take the force in a collision.
- A shoulder belt placed behind you will not protect you from injury during a collision. You are more likely to hit your head in a collision if you do not wear your shoulder belt. The lap and shoulder belt are meant to be used together.
- A frayed or torn seat belt could rip apart in a collision and leave you with no protection. Inspect the seat belt system periodically, checking for cuts, frays, or loose parts. Damaged parts must be replaced immediately. Do not disassemble or modify the seat belt system. Seat belt assemblies must be replaced after a collision.

Lap/Shoulder Belt Operating Instructions

1. Enter the vehicle and close the door. Sit back and adjust the seat.
2. The seat belt latch plate is above the back of the front seat, and next to your arm in the rear seat (for vehicles equipped with a rear seat). Grasp the latch plate and pull out the seat belt. Slide the latch plate up the webbing as far as necessary to allow the seat belt to go around your lap.
3. When the seat belt is long enough to fit, insert the latch plate into the buckle until you hear a "click."
4. Position the lap belt so that it is snug and lies low across your hips, below your abdomen. To remove slack in the lap belt portion, pull up on the shoulder



Pulling Out The Latch Plate

- 1 — Seat Belt Latch Plate
2 — Seat Belt Buckle

GETTING STARTED

belt. To loosen the lap belt if it is too tight, tilt the latch plate and pull on the lap belt. A snug seat belt reduces the risk of sliding under the seat belt in a collision.

5. Position the shoulder belt across the shoulder and chest with minimal, if any slack so that it is comfortable and not resting on your neck. The retractor will withdraw any slack in the shoulder belt.
6. To release the seat belt, push the red button on the buckle. The seat belt will automatically retract to its stowed position. If necessary, slide the latch plate down the webbing to allow the seat belt to retract fully.

Lap/Shoulder Belt Untwisting Procedure

Use the following procedure to untwist a twisted lap/shoulder belt.

1. Position the latch plate as close as possible to the anchor point.
2. At about 6 to 12 inches (15 to 30 cm) above the latch plate, grasp and twist the seat belt webbing 180 degrees to create a fold that begins immediately above the latch plate.
3. Slide the latch plate upward over the folded webbing. The folded webbing must enter the slot at the top of the latch plate.
4. Continue to slide the latch plate up until it clears the folded webbing and the seat belt is no longer twisted.

Seat Belt Extender

If a seat belt is not long enough to fit properly, even when the webbing is fully extended and the adjustable upper shoulder belt anchorage (if equipped) is in its lowest position, your authorized dealer can provide you with a Seat Belt Extender. The Seat Belt Extender should be used only if the existing seat belt is not long enough. When the Seat Belt Extender is not required for a different occupant, it must be removed.

WARNING!

- ONLY use a Seat Belt Extender if it is physically required in order to properly fit the original seat belt system. DO NOT USE the Seat Belt Extender if, when worn, the distance between the front edge of the Seat Belt Extender buckle and the center of the occupant's body is LESS than 6 inches.
- Using a Seat Belt Extender when not needed can increase the risk of serious injury or death in a collision. Only use the Seat Belt Extender when the lap belt is not long enough and only use in the recommended seating positions. Remove and store the Seat Belt Extender when not needed.

Seat Belts And Pregnant Women

Seat belts must be worn by all occupants including pregnant women: the risk of injury in the event of an accident is reduced for the mother and the unborn child if they are wearing a seat belt.

Position the lap belt snug and low below the abdomen and across the strong bones of the hips. Place the shoulder belt across the chest and away from the neck. Never place the shoulder belt behind the back or under the arm.

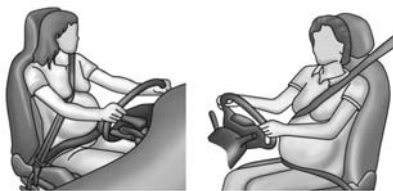

Pregnant Women And Seat Belts

Seat Belt Pretensioner

The front seat belt system is equipped with pretensioning devices that are designed to remove slack from the seat belt in the event of a collision. These devices may improve the performance of the seat belt by removing slack from the seat belt early in a collision. Pretensioners work for all size occupants, including those in child restraints.

NOTE:

These devices are not a substitute for proper seat belt placement by the occupant. The seat belt still must be worn snugly and positioned properly.

The pretensioners are triggered by the Occupant Restraint Controller (ORC). Like the air bags, the pretensioners are single use items. A deployed pretensioner or a deployed air bag must be replaced immediately.

Energy Management Feature

This vehicle has a seat belt system with an Energy Management feature in the front seating positions that may help further reduce the risk of injury in the event of a collision. This seat belt system has a retractor assembly that is designed to release webbing in a controlled manner.

GETTING STARTED

Switchable Automatic Locking Retractor (ALR)

The seat belt in the passenger seating position is equipped with a Switchable Automatic Locking Retractor (ALR) which is used to secure a child restraint system. For additional information, refer to "Installing Child Restraints Using The Vehicle Seat Belt" under the "Child Restraints" section of this manual. The figure below illustrates the locking feature for each seating position.

The figure below illustrates the locking feature for each seating position.

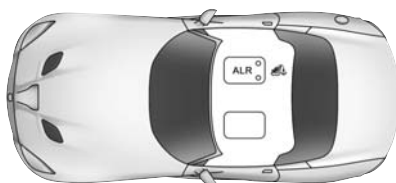

Automatic Locking Retractor (ALR) Location

ALR = Switchable Automatic Locking Retractor

If the passenger seating position is equipped with an ALR and is being used for normal usage, only pull the seat belt webbing out far enough to comfortably wrap around the occupant's mid-section so as to not activate the ALR. If the ALR is activated, you will hear a clicking sound as the seat belt retracts. Allow the webbing to retract completely in this case and then carefully pull out only the amount of webbing necessary to comfortably wrap around the occupant's mid-section. Slide the latch plate into the buckle until you hear a "click."

In Automatic Locking Mode, the shoulder belt is automatically pre-locked. The seat belt will still retract to remove any slack in the shoulder belt. Use the Automatic Locking Mode anytime a child restraint is installed in a seating position that has a seat belt with this feature. Children 12 years old and under should always be properly restrained in a vehicle with a rear seat.

WARNING!

- Never place a rear-facing child restraint in front of an air bag. A deploying passenger front air bag can cause death or serious injury to a child 12 years or younger, including a child in a rear-facing child restraint.
- Only use a rear-facing child restraint in a vehicle with a rear seat.

How To Engage The Automatic Locking Mode

1. Buckle the combination lap and shoulder belt.
2. Grasp the shoulder portion and pull downward until the entire seat belt is extracted.
3. Allow the seat belt to retract. As the seat belt retracts, you will hear a clicking sound. This indicates the seat belt is now in the Automatic Locking Mode.

How To Disengage The Automatic Locking Mode

Unbuckle the combination lap/shoulder belt and allow it to retract completely to disengage the Automatic Locking Mode and activate the vehicle sensitive (emergency) locking mode.

WARNING!

- The seat belt assembly must be replaced if the switchable Automatic Locking Retractor (ALR) feature or any other seat belt function is not working properly when checked according to the procedures in the Service Manual.
- Failure to replace the seat belt assembly could increase the risk of injury in collisions.
- Do not use the Automatic Locking Mode to restrain occupants who are wearing the seat belt or children who are using booster seats. The locked mode is only used to install rear-facing or forward-facing child restraints that have a harness for restraining the child.

Supplemental Restraint System (SRS)

Some of the safety features described in this section may be standard equipment on some models, or may be optional equipment on others. If you are not sure, ask your authorized dealer.

The air bag system must be ready to protect you in a collision. The Occupant Restraint Controller (ORC) monitors the internal circuits and interconnecting wiring associated with the electrical Air Bag System Components. Your vehicle may be equipped with the following Air Bag System Components:

Air Bag System Components

Some of the safety features described in this section may be standard equipment on some models, or may be optional equipment on others. If you are not sure, ask your authorized dealer.

Your vehicle may be equipped with the following air bag system components:

- Occupant Restraint Controller (ORC)
- Air Bag Warning Light 
- Steering Wheel and Column
- Instrument Panel
- Knee Impact Bolsters
- Driver and Front Passenger Air Bags

GETTING STARTED

- Supplemental Side Air Bags
- Front and Side Impact Sensors
- Seat Belt Pretensioners
- Seat Track Position Sensors
- Seat Belt Buckle Switch
- Occupant Classification System

Air Bag Warning Light

 The ORC monitors the readiness of the electronic parts of the air bag system whenever the ignition switch is in the START or ON/RUN position. If the ignition switch is in the OFF position or in the ACC position, the air bag system is not on and the air bags will not inflate.

The ORC contains a backup power supply system that may deploy the air bag system even if the battery loses power or it becomes disconnected prior to deployment.

The ORC turns on the Air Bag Warning Light in the instrument panel for approximately four to eight seconds for a self-check when the ignition switch is first in the ON/RUN position. After the self-check, the Air Bag Warning Light will turn off. If the ORC detects a malfunction in any part of the system, it turns on the Air Bag Warning Light, either momentarily or continuously. A single chime will sound to alert you if the light comes on again after initial startup.

The ORC also includes diagnostics that will illuminate the instrument panel Air Bag Warning Light if a malfunction is detected that could affect the air bag system. The diagnostics also record the nature of the malfunction. While the air bag system is designed to be maintenance free, if any of the following occurs, have an authorized dealer service the air bag system immediately.

- The Air Bag Warning Light does not come on during the four to eight seconds when the ignition switch is first in the ON/RUN position.
- The Air Bag Warning Light remains on after the four to eight-second interval.
- The Air Bag Warning Light comes on intermittently or remains on while driving.

NOTE:

If the speedometer, tachometer, or any engine related gauges are not working, the Occupant Restraint Controller (ORC) may also be disabled. In this condition the air bags may not be ready to inflate for your protection. Have an authorized dealer service the air bag system immediately.

WARNING!

Ignoring the Air Bag Warning Light in your instrument panel could mean you won't have the air bag system to protect you in a collision. If the light does not come on as a bulb check when the ignition is first turned on, stays on after you start the vehicle, or if it comes on as you drive, have an authorized dealer service the air bag system immediately.

Front Air Bags

This vehicle has front air bags and lap/shoulder belts for both the driver and front passenger. The front air bags are a supplement to the seat belt restraint systems. The driver front air bag is mounted in the center of the steering wheel. The passenger front air bag is mounted in the instrument panel, above the glove compartment. The words “SRS AIRBAG” or “AIRBAG” are embossed on the air bag covers.



Advanced Front Air Bag And Knee Impact Bolster Locations

- 1 — Driver And Passenger Front Air Bags
- 2 — Passenger Knee Impact Bolster
- 3 — Driver Knee Impact Bolster

WARNING!

- Being too close to the steering wheel or instrument panel during Advanced Front Air Bag deployment could cause serious injury, including death. Air bags need room to inflate. Sit back, comfortably extending your arms to reach the steering wheel or instrument panel.
- Never place a rear-facing child restraint in front of an air bag. A deploying Passenger Advanced Front Air Bag can cause death or serious injury to a child 12 years or younger, including a child in a rear-facing child restraint.
- Only use a rear-facing child restraint in a vehicle with a rear seat.

Driver and Passenger Front Air Bag Features

The Advanced Front Air Bag system has multistage driver and front passenger air bags. This system provides output appropriate to the severity and type of collision as determined by the Occupant Restraint Controller (ORC), which may receive information from the front impact sensors (if equipped) or other system components.

GETTING STARTED

The first stage inflator is triggered immediately during an impact that requires air bag deployment. A low energy output is used in less severe collisions. A higher energy output is used for more severe collisions.

This vehicle may be equipped with a driver and/or front passenger seat belt buckle switch that detects whether the driver or front passenger seat belt is buckled. The seat belt buckle switch may adjust the inflation rate of the Advanced Front Air Bags.

This vehicle may be equipped with driver and/or front passenger seat track position sensors that may adjust the inflation rate of the Advanced Front Air Bags based upon seat position.

This vehicle has an Occupant Classification System (“OCS”) in the front passenger seat. The OCS is designed to activate or deactivate the Passenger Advanced Front Air Bag depending on the occupant’s seated weight. It is designed to deactivate the Passenger Advanced Front Air Bag for an unoccupied seat and for occupants whose seated weight classifies them in a category other than a properly seated adult. This could be a child, teenager, or even an adult.

The Passenger Air Bag Disable (“PAD”) Indicator Light (an amber light located in the center of the instrument panel) tells the driver and front passenger when the Passenger Advanced Front Air Bag is deactivated. The PAD Indicator Light illuminates the words “PASSENGER AIR BAG OFF” to show that the Passenger Advanced Front Air Bag will not deploy during a collision.

NOTE:

When the front passenger seat is empty or when very light objects are placed on the seat, the Passenger Advanced Front Air Bag will not deploy even though the Passenger Air Bag Disable (PAD) System Indicator Light is NOT illuminated.

WARNING!

- No objects should be placed over or near the air bag on the instrument panel or steering wheel because any such objects could cause harm if the vehicle is in a collision severe enough to cause the air bag to inflate.
- Do not put anything on or around the air bag covers or attempt to open them manually. You may damage the air bags and you could be injured because the air bags may no longer be functional. The protective covers for the air bag cushions are designed to open only when the air bags are inflating.
- Relying on the air bags alone could lead to more severe injuries in a collision. The air bags work with your seat belt to restrain you properly. In some collisions, air bags won't deploy at all. Always wear your seat belts even though you have air bags.

Front Air Bag Operation

Front Air Bags are designed to provide additional protection by supplementing the seat belts. Front air bags are not expected to reduce the risk of injury in rear, side, or rollover collisions. The front air bags will not deploy in all frontal collisions, including some that may produce substantial vehicle damage — for example, some pole collisions, truck underrides, and angle offset collisions.

On the other hand, depending on the type and location of impact, front air bags may deploy in crashes with little vehicle front-end damage but that produce a severe initial deceleration.

Because air bag sensors measure vehicle deceleration over time, vehicle speed and damage by themselves are not good indicators of whether or not an air bag should have deployed.

Seat belts are necessary for your protection in all collisions, and also are needed to help keep you in position, away from an inflating air bag.



When the ORC detects a collision requiring the front air bags, it signals the inflator units. A large quantity of non-toxic gas is generated to inflate the front air bags.

The steering wheel hub trim cover and the upper right side of the instrument panel separate and fold out of the way as the air bags inflate to their full size. The front air bags fully inflate in less time than it takes to blink your eyes. The front air bags then quickly deflate while helping to restrain the driver and front passenger.

Occupant Classification System (OCS) — Front Passenger Seat

The OCS is part of a Federally regulated safety system for this vehicle. It is designed to activate or deactivate the Passenger Advanced Front Air Bag depending on the occupant's seated weight. It is designed to deactivate the Passenger Advanced Front Air Bag for an unoccupied seat and for occupants whose seated weight classifies them in a category other than a properly seated adult. This could be a child, teenager, or even an adult.

The Occupant Classification System (OCS) consists of the following:

- Occupant Restraint Controller (ORC)
- Occupant Classification Module (OCM) and Sensor located in the front passenger seat
- Passenger Air Bag Disabled (PAD) Indicator Light – an amber light located in the center of the instrument panel 
- Air Bag Warning Light 

Occupant Classification Module (OCM) and Sensor

The Occupant Classification Module (OCM) is located underneath the front passenger seat. The Sensor is located beneath the passenger seat cushion foam. Any weight on the seat will be sensed by the Sensor. The OCM uses input from the Sensor to determine the front passenger's most probable classification. The OCM communicates this information to the ORC. The ORC uses the classification to determine whether it should activate or

GETTING STARTED

deactivate the Passenger Advanced Front Air Bag. In order for the OCS to operate as designed, it is important for the front passenger to be seated properly and properly wearing the seat belt. Properly seated passengers are:

- Sitting upright.
- Facing forward.
- Sitting in the center of the seat with their feet comfortably on or near the floor.
- Sitting with their back against the seat back and the seat back in an upright position.

The OCS may deactivate the deployment of the Passenger Advanced Front Air Bag if the OCS estimates that:

- The front passenger seat is unoccupied or has very light objects in it.
- The front passenger seat is occupied by a rear-facing child restraint.
- The front passenger seat is occupied by a child, including a child seated in a forward-facing child restraint or booster seat.
- The front passenger seat is occupied by a small passenger, including a child or small adult.
- The front passenger is not properly seated or his or her weight is taken off of the seat for a period of time.

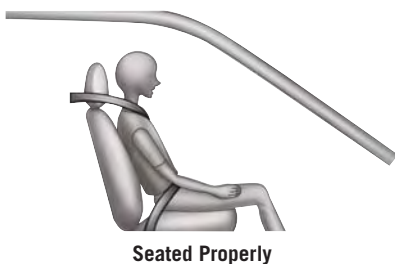

Passenger Air Bag Disable (PAD) System		
Front Passenger Seat Occupant Status	Front Passenger Air Bag Output	Front Passenger Air Bag Status
Unoccupied seat*	NOT ILLUMINATED	DEACTIVATED
Grocery bags, heavy briefcases, and other relatively light objects	"PASSENGER AIR BAG OFF"	DEACTIVATED
Rear-facing child restraint**	"PASSENGER AIR BAG OFF"	DEACTIVATED
Child, including a child in a forward-facing child restraint or booster seat*	"PASSENGER AIR BAG OFF"	DEACTIVATED
Small adult	"PASSENGER AIR BAG OFF"	DEACTIVATED
Properly seated adult	NOT ILLUMINATED	ACTIVATED

* When the front passenger seat is empty or when very light objects are placed on the seat, the Passenger Advanced Front Air Bag will not deploy even though the PAD System Indicator Light is NOT illuminated.

** It is possible for a child to be classified as an adult, allowing the deployment of the Passenger Advanced Front Air Bag. Never allow children to ride in the front passenger seat and never install a child restraint system, including a rear-facing child restraint, in this vehicle.

WARNING!

- Never place a rear-facing child restraint in front of an air bag. A deploying passenger front air bag can cause death or serious injury to a child 12 years or younger, including a child in a rear-facing child restraint.
- Only use a rear-facing child restraint in a vehicle with a rear seat.
- Children 12 years or younger should always ride buckled up in a vehicle with a rear seat.

Passenger Advanced Front Air Bag Disabled (PAD) Indicator Light

The Passenger Advanced Front Air Bag Disabled (PAD) Indicator Light (an amber light located in the center of the instrument panel) tells the driver and front passenger when the Passenger Advanced Front Air Bag is deactivated. The PAD Indicator light illuminates the words “PASSENGER AIR BAG OFF” to show that the Passenger Advanced Front Air Bag will not deploy during a collision. When the front passenger seat is empty or when very light objects are placed on the seat, the Passenger Advanced Front Air Bag will not deploy even though the PAD indicator light is NOT illuminated.

The PAD indicator light should not be illuminated when an adult passenger is properly seated in the front passenger seat. The driver and adult passenger should verify that the PAD Indicator Light is not illuminated when an adult is riding in the front passenger seat. If an adult is not seated properly, the Passenger Advanced Front Air Bag may deactivate and the PAD Indicator Light will be illuminated.

The PAD Indicator Light should be illuminated and the Passenger Advanced Front Air Bag should be deactivated for most properly seated and restrained children in the passenger seat and for most properly installed child restraint systems. However, under certain conditions, even with a properly installed child restraint system, the PAD Indicator Light may not be illuminated, even though the Passenger Advanced Front Air Bag is deactivated. This can occur if the child restraint is lighter than the lightest weight necessary to illuminate the PAD Indicator Light. NEVER assume the Passenger Advanced Front Air Bag is deactivated unless the PAD Indicator Light is illuminated with the words “PASSENGER AIR BAG OFF.”

If the PAD Indicator Light is Illuminated for an Adult Passenger:

If an adult passenger is seated in the front passenger seat and the PAD Indicator Light is illuminated, the passenger may be sitting improperly. Follow the steps below to allow the OCS to detect the adult passenger's seated weight to activate the Passenger Advanced Front Air Bag:

1. Turn off the vehicle and have the adult passenger step out of the vehicle.

GETTING STARTED

2. Remove any extra materials from the passenger seat, such as cushions, pads, seat covers, seat massagers, blankets, extra clothing, etc.
3. Place the seatback in the full upright position.
4. Have the adult passenger sit in the center of the seat, with the passenger's feet comfortably on or near the floor, and with their back against the seatback.
5. Restart the vehicle and have the passenger remain in this seated position for two to three minutes after restarting the vehicle.

WARNING!

- If the PAD Indicator Light remains illuminated for an adult passenger, have an authorized dealer service the air bag system immediately. Failure to do so may cause serious injury or death. If the PAD Indicator Light is illuminated with the words "PASSENGER AIR BAG OFF," the Passenger Advanced Front Air Bag will not deploy in the event of a collision.
- Never place a rear-facing child restraint in front of an air bag. A deploying passenger front air bag can cause death or serious injury to a child 12 years or younger, including a child in a rear-facing child restraint.
- Only use a rear-facing child restraint in a vehicle with a rear seat.
- Children 12 years or younger should always ride buckled up in a vehicle with a rear seat.

Lighter Weight Passengers (Including Small Adults)

When a lighter weight passenger, including a small adult, occupies the passenger seat, the Passenger Advanced Front Air Bag may be deactivated. Therefore, the Passenger Advanced Front Air Bag may or may not be activated for a lighter weight passenger, including a small adult (depending on size) who is seated in the passenger seat. This does not mean that the OCS is working improperly.

The driver and passenger must always use the PAD Indicator Light as a determination of whether the Passenger Advanced Front Air Bag is activated or deactivated. If the PAD Indicator Light is illuminated with the words "PASSENGER AIR BAG OFF" when an adult is in the front passenger seat, have the passenger reposition his or her body in the seat until the PAD Indicator Light goes out.

If the PAD Indicator Light is illuminated with the words "PASSENGER AIR BAG OFF" the Passenger Advanced Front Air Bag will not inflate in the event of a collision.

Do Not Decrease OR Increase The Front Passenger's Seated Weight On The Front Passenger Seat

The front passenger's seated weight must be properly positioned on the front passenger seat. Failure to do so may result in serious injury or death. The OCS determines the most probable classification of the occupant that it detects. The OCS will detect the front passenger's decreased or increased seated weight, which may result in deactivation or activation of the Passenger Advanced Front Air Bag in a collision. This does not mean that the OCS is working improperly. Decreasing the front passenger's seated weight on the front passenger seat may result in deactivation of the Passenger Advanced Front Air Bag causing serious injury or death. Increasing the front passenger's seated weight on the front passenger seat may result in activation of the Passenger Advanced Front Air Bag. Examples of improper front passenger seating include:

- The front passenger's weight is transferred to another part of the vehicle (like the door, arm rest or instrument panel).
- The front passenger leans forward, sideways, or turns to face the rear of the vehicle.
- The front passenger's seatback is not in the full upright position.
- The front passenger carries or holds an object while seated (e.g., backpack, box, etc.).
- Objects are lodged under the front passenger seat.
- Objects are lodged between the front passenger seat and center console.
- Accessories that may change the seated weight on the front passenger seat are attached to the front passenger seat.
- Anything that may decrease or increase the front passenger's seated weight.

GETTING STARTED

The OCS determines the front passenger's most probable classification. If an occupant in the front passenger seat is seated improperly, the occupant may provide an output signal to the OCS that is different from the occupant's properly seated weight input, for example:

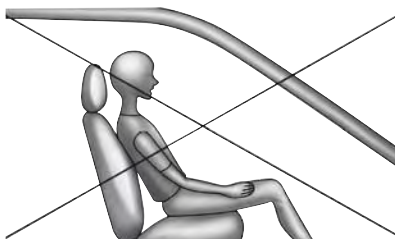

Not Seated Properly

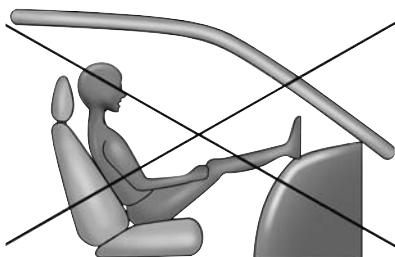

Not Seated Properly

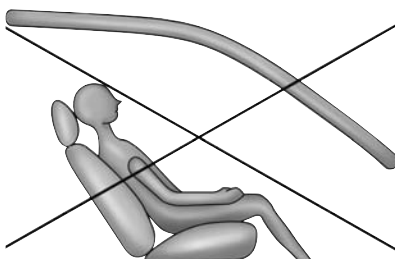

Not Seated Properly

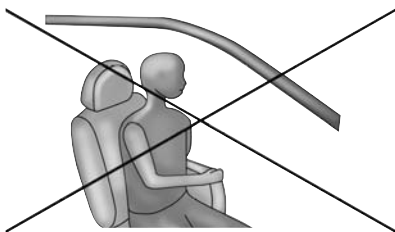

Not Seated Properly

WARNING!

- If a child restraint system, child, small teenager or adult in the front passenger seat is seated improperly, the occupant may provide an output signal to the OCS that is different from the occupant's properly seated weight input. This may result in serious injury or death in a collision.
- Always wear your seat belt and sit properly, with the seatback in an upright position, your back against the seatback, sitting upright, facing forward, in the center of the seat, with your feet comfortably on or near the floor.
- Do not carry or hold any objects (e.g., backpacks, boxes, etc.) while seated in the front passenger seat. Holding an object may provide an output signal to the OCS that is different than the occupant's properly seated weight input, which may result in serious injury or death in a collision.

The Air Bag Warning Light  will illuminate whenever the OCS is unable to classify the front passenger seat status.

A malfunction in the OCS may affect the operation of the air bag system. If the Air Bag Warning Light  does not come on, or stays on after you start the vehicle, or it comes on as you drive, take the vehicle to an authorized dealer for service immediately.

WARNING!

- Ignoring the Air Bag Warning Light in your instrument panel could mean you won't have the air bags to protect you in a collision. If the light does not come on as a bulb check when the ignition is first turned on, stays on after you start the vehicle, or if it comes on as you drive, have an authorized dealer service the air bag system immediately.
- Placing an object on the floor under the front passenger seat may prevent the OCS from working properly, which may result in serious injury or death in a collision. Do not place any objects on the floor under the front passenger seat.
- If there is a fault present in the OCS, both the PAD Indicator Light and the Air Bag Warning Light will illuminate to show that the Passenger Advanced Front Air Bag is deactivated. Should this occur, the Passenger Advanced Front Air Bag will remain deactivated until the fault is cleared. This indicates that you should take the vehicle to an authorized dealer for service immediately.

The passenger seat assembly contains critical OCS components that may affect Passenger Advanced Front Air Bag inflation. In order for the OCS to properly classify the seated weight of a front seat passenger, the OCS components must function as designed. Do not make any modifications to the front passenger seat components, assembly, or to the seat cover. If the seat, trim cover, or cushion needs service for any reason, take the vehicle to your authorized dealer. Only FCA US LLC approved seat accessories may be used.

GETTING STARTED

The following requirements must be strictly followed:

- Do not modify the front passenger seat assembly or components in any way.
- Do not use prior or future model year seat covers or cushions not designated by FCA US LLC for the specific model being repaired. Always use the correct seat cover and cushion specified for the vehicle.
- Do not replace the seat cover or cushion with an aftermarket seat cover or cushion.
- Do not add a secondary seat cover or mat.
- At no time should any Supplemental Restraint System (SRS) component or SRS related component or fastener be modified or replaced with any part except those which are approved by FCA US LLC.

WARNING!

- Unapproved modifications or service procedures to the passenger seat assembly, its related components, seat cover, or cushion may inadvertently change the air bag deployment in case of a frontal collision. This could result in death or serious injury to the front passenger if the vehicle is involved in a collision. A modified vehicle may not comply with required Federal Motor Vehicle Safety Standards (FMVSS) and/or Canadian Motor Vehicle Safety Standards (CMVSS).
- If it is necessary to modify the air bag system for persons with disabilities, contact your authorized dealer.

Knee Impact Bolsters

The Knee Impact Bolsters help protect the knees of the driver and front passenger, and position the front occupants for improved interaction with the front air bags.

WARNING!

- Do not drill, cut, or tamper with the knee impact bolsters in any way.
- Do not mount any accessories to the knee impact bolsters such as alarm lights, stereos, citizen band radios, etc.

Supplemental Side Air Bags

Supplemental Door-Integrated Side Air Bag Inflatable Curtains (SABICs)

This vehicle is equipped with Supplemental Door-Integrated Side Air Bag Inflatable Curtains (SABICs).

SABICs may help reduce the risk of head and other injuries to front seat outboard occupants in certain side impacts, in addition to the injury reduction potential provided by the seat belts and body structure.

The SABICs are located in the door trim below the side windows. The trim covering the SABICs is labeled “SRS AIRBAG” or “AIRBAG.”

The SABICs may help reduce the risk of partial or complete ejection of vehicle occupants through side windows in certain side impact events.

The SABICs deploy upward, covering the side windows. An inflating SABIC pushes the outside edge of the trim out of the way and covers the window. The SABICs inflate with enough force to injure occupants if they are not belted and seated properly, or if items are positioned in the area where the SABICs inflate. Children are at an even greater risk of injury from a deploying air bag.

SABICs are designed to activate in certain side impacts. The Occupant Restraint Controller (ORC) determines whether the deployment of the SABIC in a particular impact event is appropriate, based on the severity and type of collision. The side impact sensors aid the ORC in determining the appropriate response to impact events. The system is calibrated to deploy the SABIC on the impact side of the vehicle during impacts that require SABIC occupant protection. In side impacts, the SABICs deploy independently; a left side impact deploys the left side SABIC only and a right-side impact deploys the right side SABIC only. Vehicle damage by itself is not a good indicator of whether or not SABICs should have deployed.

SABICs will not deploy in all side collisions, including some collisions at certain angles, or some side collisions that do not impact the area of the passenger compartment. SABICs may deploy during angled or offset frontal collisions where the front air bags deploy.

SABICs are a supplement to the seat belt restraint system. SABICs deploy in less time than it takes to blink your eyes.

GETTING STARTED

WARNING!

- Occupants, including children, who are up against or very close to SABICs can be seriously injured or killed. Occupants, including children, should never lean on or sleep against the door, side windows, or area where the side air bags inflate, even if they are in an infant or child restraint.
- Seat belts (and child restraints where appropriate) are necessary for your protection in all collisions. They also help keep you in position, away from an inflating SABIC. To get the best protection from the SABICs, occupants must wear their seat belts properly and sit upright with their backs against the seats. Children must be properly restrained in a child restraint or booster seat that is appropriate for the size of the child.
- Do not stack luggage or other cargo up high enough to block the deployment of the SABICs. The door trim below the side windows where the SABIC and its deployment path are located should remain free from any obstructions.
- SABICs need room to inflate. Do not lean against the door or window. Sit upright in the center of the seat.
- Being too close to the SABICs during deployment could cause you to be severely injured or killed.
- Relying on the SABICs alone could lead to more severe injuries in a collision. The SABICs work with your seat belt to restrain you properly. In some collisions, SABICs won't deploy at all. Always wear your seat belt even though you have SABICs.

NOTE:

Air bag covers may not be obvious to you, but they will open during air bag deployment.

The SABICs may help reduce the risk of partial or complete ejection of vehicle occupants through side windows in certain side impact events.

The Occupant Restraint Controller (ORC) monitors the internal circuits and interconnecting wiring associated with electrical Air Bag System Components listed below:

Air Bag System Components

- Occupant Restraint Controller (ORC)
- Air Bag Warning Light 
- Steering Wheel and Column
- Instrument Panel
- Knee Impact Bolsters
- Driver and Front Passenger Air Bags
- Supplemental Side Air Bags
- Front and Side Impact Sensors
- Seat Belt Pretensioners
- Seat Track Position Sensors
- Seat Belt Buckle Switch
- Occupant Classification System

If A Deployment Occurs

The front air bags are designed to deflate immediately after deployment.

NOTE:

Front and/or side air bags will not deploy in all collisions. This does not mean something is wrong with the air bag system.

If you do have a collision which deploys the air bags, any or all of the following may occur:

- The air bag material may sometimes cause abrasions and/or skin reddening to the occupants as the air bags deploy and unfold. The abrasions are similar to friction rope burns or those you might get sliding along a carpet or gymnasium floor. They are not caused by contact with chemicals. They are not permanent and normally heal quickly. However, if you haven't healed significantly within a few days, or if you have any blistering, see your doctor immediately.
- As the air bags deflate, you may see some smoke-like particles. The particles are a normal by-product of the process that generates the non-toxic gas used for air bag inflation. These airborne particles may irritate the skin, eyes, nose, or throat. If you have skin or eye irritation, rinse the area with cool water. For nose or throat irritation, move to fresh air. If the irritation continues, see your doctor. If these particles settle on your clothing, follow the garment manufacturer's instructions for cleaning.

Do not drive your vehicle after the air bags have deployed. If you are involved in another collision, the air bags will not be in place to protect you.

WARNING!

Deployed air bags and seat belt pretensioners cannot protect you in another collision. Have the air bags, seat belt pretensioners, and the seat belt retractor assemblies replaced by an authorized dealer immediately. Also, have the Occupant Restraint Controller System serviced as well.

NOTE:

- Air bag covers may not be obvious in the interior trim, but they will open during air bag deployment.
- After any collision, the vehicle should be taken to an authorized dealer immediately.

Enhanced Accident Response System

In the event of an impact, if the communication network remains intact, and the power remains intact, depending on the nature of the event, the ORC will determine whether to have the Enhanced Accident Response System perform the following functions:

- Cut off fuel to the engine.
- Flash hazard lights as long as the battery has power or until the hazard light button is pressed. The hazard lights can be deactivated by pressing the hazard light button.
- Turn on the interior lights, which remain on as long as the battery has power.
- Unlock the power door locks.

GETTING STARTED

Enhanced Accident Response System Reset Procedure

In order to reset the Enhanced Accident Response System functions after an event, the ignition switch must be changed from ignition START or ON/RUN to ignition OFF. Carefully check the vehicle for fuel leaks in the engine compartment and on the ground near the engine compartment and fuel tank before resetting the system and starting the engine.

Maintaining Your Air Bag System

WARNING!

- Modifications to any part of the air bag system could cause it to fail when you need it. You could be injured if the air bag system is not there to protect you. Do not modify the components or wiring, including adding any kind of badges or stickers to the steering wheel hub trim cover or the upper right side of the instrument panel. Do not modify the front bumper, vehicle body structure, or add aftermarket side steps or running boards.
- It is dangerous to try to repair any part of the air bag system yourself. Be sure to tell anyone who works on your vehicle that it has an air bag system.
- Do not attempt to modify any part of your air bag system. The air bag may inflate accidentally or may not function properly if modifications are made. Take your vehicle to an authorized dealer for any air bag system service. If your seat, including your trim cover and cushion, needs to be serviced in any way (including removal or loosening/tightening of seat attachment bolts), take the vehicle to your authorized dealer. Only manufacturer approved seat accessories may be used. If it is necessary to modify the air bag system for persons with disabilities, contact your authorized dealer.

Event Data Recorder (EDR)

This vehicle is equipped with an event data recorder (EDR). The main purpose of an EDR is to record, in certain crash or near crash-like situations, such as an air bag deployment or hitting a road obstacle, data that will assist in understanding how a vehicle's systems performed. The EDR is designed to record data related to vehicle dynamics and safety systems for a short period of time, typically 30 seconds or less. The EDR in this vehicle is designed to record such data as:

- How various systems in your vehicle were operating;
- Whether or not the driver and passenger safety belts were buckled/fastened;
- How far (if at all) the driver was depressing the accelerator and/or brake pedal; and,
- How fast the vehicle was traveling.

- These data can help provide a better understanding of the circumstances in which crashes and injuries occur.

NOTE:

EDR data are recorded by your vehicle only if a non-trivial crash situation occurs; no data are recorded by the EDR under normal driving conditions and no personal data (e.g., name, gender, age, and crash location) are recorded. However, other parties, such as law enforcement, could combine the EDR data with the type of personally identifying data routinely acquired during a crash investigation.

To read data recorded by an EDR, special equipment is required, and access to the vehicle or the EDR is needed. In addition to the vehicle manufacturer, other parties, such as law enforcement, that have the special equipment, can read the information if they have access to the vehicle or the EDR.

Child Restraints

Everyone in your vehicle needs to be buckled up at all times, including babies and children. Every state in the United States, and every Canadian province, requires that small children ride in proper restraint systems. This is the law, and you can be prosecuted for ignoring it.

Children 12 years or younger should ride properly buckled up in a rear seat, if available. According to crash statistics, children are safer when properly restrained in the rear seats rather than in the front.

WARNING!

In a collision, an unrestrained child can become a projectile inside the vehicle. The force required to hold even an infant on your lap could become so great that you could not hold the child, no matter how strong you are. The child and others could be badly injured. Any child riding in your vehicle should be in a proper restraint for the child's size.

GETTING STARTED

There are different sizes and types of restraints for children from newborn size to the child almost large enough for an adult safety belt. Always check the child seat Owner's Manual to make sure you have the correct seat for your child. Carefully read and follow all the instructions and warnings in the child restraint Owner's Manual and on all the labels attached to the child restraint.

Before buying any restraint system, make sure that it has a label certifying that it meets all applicable Safety Standards. You should also make sure that you can install it in the vehicle where you will use it.

NOTE:

- For additional information, refer to www.seatcheck.org or call 1-866-SEATCHECK.
- Canadian residents should refer to Transport Canada's website for additional information: www.tc.gc.ca/eng/motorvehiclesafety/safedrivers-childsafety-index-53.htm

Summary Of Recommendations For Restraining Children In Vehicles

	Child Size, Height, Weight Or Age	Recommended Type Of Child Restraint
Infants and Toddlers	Children who are two years old or younger and who have not reached the height or weight limits of their child restraint	Either an Infant Carrier or a Convertible Child Restraint, facing rearward in the rear seat of the vehicle
Small Children	Children who are at least two years old or who have out-grown the height or weight limit of their rear-facing child restraint	Forward-Facing Child Restraint with a five-point Harness, facing forward in the rear seat of the vehicle
Larger Children	Children who have out-grown their forward-facing child restraint, but are too small to properly fit the vehicle's seat belt	Belt Positioning Booster Seat and the vehicle seat belt, seated in the rear seat of the vehicle
Children Too Large for Child Restraints	Children 12 years old or younger, who have out-grown the height or weight limit of their booster seat	Vehicle Seat Belt, seated in the rear seat of the vehicle

Infant And Child Restraints

Safety experts recommend that children ride rear-facing in the vehicle until they are two years old or until they reach either the height or weight limit of their rear-facing child restraint. Two types of child restraints can be used rear-facing: infant carriers and convertible child seats.

The infant carrier is only used rear-facing in the vehicle. It is recommended for children from birth until they reach the weight or height limit of the infant carrier. Convertible child seats can be used either rear-facing or forward-facing in the vehicle. Convertible child seats often have a higher weight limit in the rear-facing direction than infant carriers do, so they can be used rear-facing by children who have outgrown their infant carrier but are still less than at least two years old. Children should remain rear-facing until they reach the highest weight or height allowed by their convertible child seat.

WARNING!

- Never place a rear-facing child restraint in front of an air bag. A deploying passenger front air bag can cause death or serious injury to a child 12 years or younger, including a child in a rear-facing child restraint.
- Only use a rear-facing child restraint in a vehicle with a rear seat.

Older Children And Child Restraints

Children who are two years old or who have outgrown their rear-facing convertible child seat can ride forward-facing in the vehicle. Forward-facing child seats and convertible child seats used in the forward-facing direction are for children who are over two years old or who have outgrown the rear-facing weight or height limit of their rear-facing convertible child seat. Children should remain in a forward-facing child seat with a harness for as long as possible, up to the highest weight or height allowed by the child seat.

All children whose weight or height is above the forward-facing limit for the child seat should use a belt-positioning booster seat until the vehicle's seat belts fit properly. If the child cannot sit with knees bent over the vehicle's seat cushion while the child's back is against the seatback, they should use a belt-positioning booster seat. The child and belt-positioning booster seat are held in the vehicle by the seat belt.

WARNING!

- Improper installation can lead to failure of an infant or child restraint. It could come loose in a collision. The child could be badly injured or killed. Follow the child restraint manufacturer's directions exactly when installing an infant or child restraint.
- After a child restraint is installed in the vehicle, do not move the vehicle seat forward or rearward because it can loosen the child restraint attachments. Remove the child restraint before adjusting the vehicle seat position. When the vehicle seat has been adjusted, reinstall the child restraint.
- When your child restraint is not in use, secure it in the vehicle with the seat belt or LATCH anchorages, or remove it from the vehicle. Do not leave it loose in the vehicle. In a sudden stop or accident, it could strike the occupants or seatbacks and cause serious personal injury.

GETTING STARTED

Children Too Large For Booster Seats

Children who are large enough to wear the shoulder belt comfortably, and whose legs are long enough to bend over the front of the seat when their back is against the seatback, should use the seat belt in a rear seat. Use this simple 5-step test to decide whether the child can use the vehicle's seat belt alone:

1. Can the child sit all the way back against the back of the vehicle seat?
2. Do the child's knees bend comfortably over the front of the vehicle seat – while they are still sitting all the way back?
3. Does the shoulder belt cross the child's shoulder between their neck and arm?
4. Is the lap part of the belt as low as possible, touching the child's thighs and not their stomach?
5. Can the child stay seated like this for the whole trip?

If the answer to any of these questions was “no,” then the child still needs to use a booster seat in this vehicle. If the child is using the lap/shoulder belt, check seat belt fit periodically and make sure the seat belt buckle is latched. A child's squirming or slouching can move the belt out of position. If the shoulder belt contacts the face or neck, move the child closer to the center of the vehicle, or use a booster seat to position the seat belt on the child correctly.

WARNING!

Never allow a child to put the shoulder belt under an arm or behind their back. In a crash, the shoulder belt will not protect a child properly, which may result in serious injury or death. A child must always wear both the lap and shoulder portions of the seat belt correctly.

Installing Child Restraints Using The Vehicle Seat Belt

Child restraint systems are designed to be secured in vehicle seats by lap belts or the lap belt portion of a lap/shoulder belt.

WARNING!

- Improper installation or failure to properly secure a child restraint can lead to failure of the restraint. The child could be badly injured or killed.
- Follow the child restraint manufacturer's directions exactly when installing an infant or child restraint.

GETTING STARTED

The seat belts in the passenger seating positions are equipped with a Switchable Automatic Locking Retractor (ALR) that is designed to keep the lap portion of the seat belt tight around the child restraint so that it is not necessary to use a locking clip. The ALR retractor can be “switched” into a locked mode by pulling all of the webbing out of the retractor and then letting the webbing retract back into the retractor. If it is locked, the ALR will make a clicking noise while the webbing is pulled back into the retractor. Refer to the “Automatic Locking Mode” description under “Occupant Restraints” for additional information on ALR.

Lap/Shoulder Belt Systems For Installing Child Restraints In This Vehicle

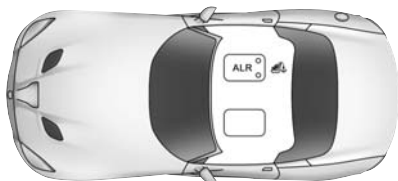

Automatic Locking Retractor (ALR) Locations

Frequently Asked Questions about installing child restraints with seat belts		
What is the weight limit (child's weight + weight of the child restraint) for using the Tether Anchor with the seat belt to attach a forward facing child restraint?	Weight limit of the Child Restraint	Always use the tether anchor when using the seat belt to install a forward facing child restraint, up to the recommended weight limit of the child restraint.
Can the head restraints be removed?	No	
Can the buckle stalk be twisted to tighten the seat belt against the belt path of the child restraint?	No	

GETTING STARTED

Installing A Child Restraint With A Switchable Automatic Locking Retractor (ALR)

Child restraint systems are designed to be secured in vehicle seats by lap belts or the lap belt portion of a lap/shoulder belt.

WARNING!

- Improper installation or failure to properly secure a child restraint can lead to failure of the restraint. The child could be badly injured or killed.
- Follow the child restraint manufacturer's directions exactly when installing an infant or child restraint.

1. Place the child seat in the center of the seating position. Move the vehicle seat as far rearward as possible to keep the child as far from the advanced passenger air bag as possible.
2. Pull enough of the seat belt webbing from the retractor to pass it through the belt path of the child restraint. Do not twist the belt webbing in the belt path.
3. Slide the latch plate into the buckle until you hear a "click."
4. Pull on the webbing to make the lap portion tight against the child seat.
5. To lock the seat belt, pull down on the shoulder part of the belt until you have pulled all the seat belt webbing out of the retractor. Then, allow the webbing to retract back into the retractor. As the webbing retracts, you will hear a clicking sound. This means the seat belt is now in the Automatic Locking mode.
6. Try to pull the webbing out of the retractor. If it is locked, you should not be able to pull out any webbing. If the retractor is not locked, repeat step 5.
7. Finally, pull up on any excess webbing to tighten the lap portion around the child restraint while you push the child restraint rearward and downward into the vehicle seat.
8. If the child restraint has a top tether strap and the seating position has a top tether anchorage, connect the tether strap to the anchorage and tighten the tether strap. See the section "Installing Child Restraints Using the Top Tether Anchorage" for directions to attach a tether anchor.
9. Test that the child restraint is installed tightly by pulling back and forth on the child seat at the belt path. It should not move more than 1 inch (25.4 mm) in any direction.

Any seat belt system will loosen with time, so check the belt occasionally, and pull it tight if necessary.

Installing Child Restraints Using The Top Tether Anchorage

WARNING!

Do not attach a tether strap for a rear-facing car seat to any location in front of the car seat, including the seat frame or a tether anchorage. Only attach the tether strap of a rear-facing car seat to the tether anchorage that is approved for that seating position, located behind the top of the vehicle seat. See the section “Lower Anchors and Tethers for Children (LATCH) Restraint System” for the location of approved tether anchorages in your vehicle.



There is a tether strap anchor  located behind the child tether access cover behind the passenger seat. To attach a child restraint tether strap to the anchor:

1. Move the seat forward.
2. Move the seatback to its full forward position.

GETTING STARTED

3. Remove the child tether access cover by prying either side with a screwdriver or similar tool, as shown.



Child Tether Anchorage Access Cover



Child Tether Anchorage

NOTE:

While the child tether is in use, keep the access cover in a safe place so that it can be replaced after use of the child tether.

4. Pass the child restraint tether hook through either opening in the seatback underneath the head restraint.

5. Attach the tether hook to the anchor loop.
6. Move the seat to its farthest rearward position. Apply body pressure to the seat to be sure the seat adjusters have latched.
7. Return the seatback to an upright position.
8. Remove slack from the tether strap according to the child restraint manufacturer's directions.



Tether Attached

WARNING!

An incorrectly anchored tether strap could lead to increased head motion and possible injury to the child. Use only the anchorage position directly behind the child seat to secure a child restraint top tether strap.

NON-ADJUSTABLE HEAD RESTRAINTS

The non-adjustable head restraints are form fitted into the upper structure of the seatback and are designed to reduce the risk of injury by restricting head movement in the event of a rear impact. The seatback should be properly adjusted to an upright position where the head restraint is positioned as close as possible to the back of your head.

WARNING!

Be certain that the seatback is locked securely into position. Otherwise, the seat will not provide the proper stability for passengers. An improperly latched seatback could cause serious injury.

GETTING STARTED

FRONT SEATS

Power Seats

On models equipped with power seats, the power seat switch is located on the out-board side of the seat near the floor.

Adjusting The Seat Forward Or Rearward

The seat can be adjusted both forward and rearward. Push the seat switch forward or rearward. The seat will move in the direction of the switch. Release the switch when the desired position has been reached.



Power Seat Switches

- 1 — Power Recline Switch
- 2 — Power Seat Switch

Adjusting The Seat Up Or Down

The height of the seats can be adjusted up or down. Pull upward or push downward on the seat switch, the seat will move in the direction of the switch. Release the switch when the desired position is reached.

Reclining The Seatback Forward Or Rearward

The seatback can be reclined both forward and rearward. Push the power seat recliner switch forward or rearward, the seatback will move in the direction of the switch. Release the switch when the desired position has been reached.

WARNING!

- Adjusting a seat while driving may be dangerous. Moving a seat while driving could result in loss of control which could cause a collision and serious injury or death.
- Seats should be adjusted before fastening the seat belts and while the vehicle is parked. Serious injury or death could result from a poorly adjusted seat belt.
- Do not ride with the seatback reclined so that the shoulder belt is no longer resting against your chest. In a collision you could slide under the seat belt, which could result in serious injury or death.

CAUTION!

Do not place any article under a power seat or impede its ability to move as it may cause damage to the seat controls. Seat travel may become limited if movement is stopped by an obstruction in the seat's path.

Manual Seats

Forward And Rearward Adjustment

The adjusting bar is at the front of the seat, near the floor. Pull the bar upward to move the seat forward or rearward. Release the bar once the seat is in the desired position. Then, using body pressure, move forward and rearward on the seat to be sure that the seat adjusters have latched.

Seat Height Adjustment

The seat height adjustment lever is located on the outboard side of the seat. Pull upward on the lever to raise the seat height or push downward on the lever to lower the seat height.

Recliner Adjustment

The recliner lever is located on the outboard side of the seat. To recline the seat, lean forward slightly, pull the recliner lever upward, lean backward until the seat is in the desired position, and release the lever. To return the seat to its full upright position, lean forward, pull the recliner lever upward and hold it until the seat returns to its full upright position.



Seat Adjustments

- 1 — Seat Adjustment Bar
- 2 — Recline Lever
- 3 — Height Adjustment Lever

WARNING!

- Adjusting a seat while driving may be dangerous. Moving a seat while driving could result in loss of control which could cause a collision and serious injury or death.
- Seats should be adjusted before fastening the seat belts and while the vehicle is parked. Serious injury or death could result from a poorly adjusted seat belt.
- Do not ride with the seatback reclined so that the shoulder belt is no longer resting against your chest. In a collision you could slide under the seat belt, which could result in serious injury or death.

GETTING STARTED

ADJUSTABLE PEDALS

The adjustable pedals system is designed to allow a greater range of driver comfort for steering wheel tilt and seat position. This feature allows the brake, accelerator, and clutch pedal to move toward or away from the driver to provide improved position with the steering wheel.

The adjustable pedal switch is located to the left side of the steering column.

Push the switch forward to move the pedals forward (toward the front of the vehicle).

Push the switch rearward to move the pedals rearward (toward the driver).

NOTE:

- The pedals can be adjusted with the ignition OFF.
- Always adjust the pedals to a position that allows full pedal travel.
- Further small adjustments may be necessary to find the best possible seat/pedal position.



Adjustable Pedal Switch

WARNING!

Do not adjust the pedals while the vehicle is moving. You could lose control and have an accident. Always adjust the pedals while the vehicle is parked.

CAUTION!

Do not place any article under the adjustable pedals or impede its ability to move as it may cause damage to the pedal controls. Pedal travel may become limited if movement is stopped by an obstruction in the adjustable pedal's path.

ADJUSTABLE FOOT REST

This feature allows the driver to adjust the foot rest forward or backward and to rotate it upward or downward to allow for greater driving comfort.

To adjust the pedal:

1. Adjust the seat and steering column to a comfortable position.
2. Using a socket wrench, loosen the nut on the pedal.
3. Slide the pedal either forward or backward and rotate it upward or downward as desired.
4. Tighten the nut, being careful not to over tighten it.



Adjustable Foot Rest Location

TILT STEERING COLUMN

The tilt release lever is located below the multifunction lever on the left side of the steering column. To tilt the column, simply pull the release lever rearward toward you and then move the steering wheel upward or downward as desired. When the column is in the desired position, push the release lever forward to lock the column firmly in place.



Tilt Steering Column Lever

WARNING!

Do not adjust the steering column while driving. Adjusting the steering column while driving or driving with the steering column unlocked, could cause the driver to lose control of the vehicle. Failure to follow this warning may result in serious injury or death.

OPERATING YOUR VEHICLE

SRT ENGINE BREAK-IN RECOMMENDATIONS

SRT Engine Break-In Recommendations: The following tips will be helpful in obtaining optimum performance and maximum durability for your new SRT Vehicle.

Despite modern technology and World Class manufacturing methods, the moving parts of the vehicle must still wear in with each other. This wearing in occurs mainly during the first 500 miles (805 km) and continues through the first oil change interval.

It is recommended for the operator to observe the following driving behaviors during the new vehicle break-in period:

0 to 100 miles (0 to 161 km):

- Do not allow the engine to operate at idle for an extended period of time.
- Depress the accelerator pedal slowly and not more than halfway to avoid rapid acceleration.
- Avoid aggressive braking.
- Drive with the engine speed less than 3,500 RPM.
- Maintain vehicle speed below 55 mph (88 km/h) and observe local speed limits.

100 to 300 miles (161 to 483 km):

- Depress the accelerator pedal slowly and not more than halfway to avoid rapid acceleration in lower gears (1st to 3rd gears).
- Avoid aggressive braking.
- Drive with the engine speed less than 5,000 RPM.
- Maintain vehicle speed below 70 mph (112 km/h) and observe local speed limits.

300 to 500 miles (483 to 805 km):

- Exercise the full engine rpm range, shifting manually (paddles or gear shift) at higher rpms when possible.
- Do not perform sustained operation with the accelerator pedal at wide open throttle.
- Maintain vehicle speed below 85 mph (136 km/h) and observe local speed limits.

For the first 1500 miles (2414 km):

- Do not participate in track events, sport driving schools, or similar activities during the first 1500 miles (2414 km).

NOTE:

Check engine oil with every refueling and add if necessary. Oil and fuel consumption may be higher through the first oil change interval.

TURN SIGNALS/WIPER/WASHER/HIGH BEAMS LEVER



Turn Signal/Wiper/Washer/High Beam Lever

Wipers

Intermittent, Low And High Operation

Rotate the end of the lever to the first detent position for one of five intermittent settings, the second detent for low wiper operation and the third detent for high wiper operation.

Washer Operation

Push the end of the lever inward to the second detent and hold for as long as spray is desired.

Mist Feature

When a single wipe to clear off road mist or spray from a passing vehicle is needed, push the washer knob, located on the end of the multifunction lever, inward to the first detent and release. The wipers will cycle one time and automatically shut off.

High Beams

Push the lever away from you to activate the high beams. A high beam symbol will illuminate in the cluster to indicate the high beams are on.



NOTE:

For safe driving, turn off the high beams when oncoming traffic is present to prevent headlight glare and as a courtesy to other motorists.

OPERATING YOUR VEHICLE

HEADLIGHT SWITCH

Automatic Headlights/Parking Lights/Headlights

- Rotate the headlight switch, located on the instrument panel to the left of the steering wheel, to the first detent from the off position for parking light  and to the second detent for headlight .
- Rotate the headlight switch to “AUTO” for AUTO headlights.

NOTE:

When set to AUTO, the system automatically turns the headlights on or off based on ambient light levels.

Instrument Panel Dimmer

- Rotate the dimmer control to the extreme bottom position to fully dim the instrument panel lights and prevent the interior lights from illuminating when a door is opened.
- Rotate the dimmer control up to increase the brightness of the instrument panel when the parking lights or headlights are on.
- Rotate the dimmer control up to the next detent position to fully brighten the odometer when the parking lights or headlights are on.
- Rotate the dimmer control up to the last detent position to turn on the interior lighting.

NOTE:

The touchscreen dimming is programmable through the Uconnect system. Refer to “Uconnect Settings” in “Understanding Your Instrument Panel” in the Owner’s Manual on the DVD for further details.



Headlight Switch

- 1 — Rotate Headlight Switch
- 2 — Rotate Dimmer

OPERATING YOUR VEHICLE

ELECTRONIC SPEED CONTROL

When engaged, the Electronic Speed Control takes over accelerator operations at speeds greater than 25 mph (40 km/h).

The Electronic Speed Control buttons are located on the right side of the steering wheel.

NOTE:

In order to ensure proper operation, the Electronic Speed Control System has been designed to shut down if multiple speed control buttons are pushed at the same time. If this occurs, the Electronic Speed Control System can be reactivated by pushing the Electronic Speed Control ON/OFF button and resetting the desired vehicle set speed.



Electronic Speed Control Switches

- 1 — Push Cancel
- 2 — Push On/Off
- 3 — Push Resume/Accel
- 4 — Push Set/Decel

WARNING!

Electronic Speed Control can be dangerous where the system cannot maintain a constant speed. Your vehicle could go too fast for the conditions, and you could lose control and have an accident. Do not use Electronic Speed Control in heavy traffic or on roads that are winding, icy, snow-covered or slippery.

To Activate

Push the ON/OFF button to activate the Electronic Speed Control. The Cruise Indicator Light in the instrument cluster display will illuminate. To turn the system off, push the ON/OFF button a second time. The Cruise Indicator Light will turn off. The system should be turned off when not in use.

OPERATING YOUR VEHICLE

WARNING!

Leaving the Electronic Speed Control system on when not in use is dangerous. You could accidentally set the system or cause it to go faster than you want. You could lose control and have an accident. Always leave the system off when you are not using it.

To Set A Desired Speed

Turn the Electronic Speed Control on. When the vehicle has reached the desired speed, push the SET (-) button and release. Release the accelerator and the vehicle will operate at the selected speed.

NOTE:

The vehicle should be traveling at a steady speed and on level ground before pushing the SET (-) button.

To Deactivate

A soft tap on the brake pedal, pushing the CANCEL button, manually accelerating 10 mph (16 km/h) above the set speed or normal brake pressure while slowing the vehicle will deactivate the Electronic Speed Control without erasing the set speed memory.

Pushing the ON/OFF button, or turning the ignition switch OFF, erases the set speed memory.

To Resume Speed

To resume a previously set speed, push the RES (+) button and release. Resume can be used at any speed above 20 mph (32 km/h).

To Vary The Speed Setting

To Increase Speed

When the Electronic Speed Control is set, you can increase speed by pushing the RES (+) button.

The driver's preferred units can be selected through the instrument panel settings if equipped. Refer to "Programmable Features" in "Understanding Your Instrument Panel" in the Owner's Manual on the DVD for more information. The speed increment shown is dependent on the selected speed unit of U.S. (mph) or Metric (km/h):

U.S. Speed (mph)

- Pushing the RES (+) button once will result in a 1 mph increase in set speed. Each subsequent tap of the button results in an increase of 1 mph.
- If the button is continually pushed, the set speed will continue to increase until the button is released, then the new set speed will be established.

Metric Speed (km/h)

- Pushing the RES (+) button once will result in a 1 km/h increase in set speed. Each subsequent tap of the button results in an increase of 1 km/h.

- If the button is continually pushed, the set speed will continue to increase until the button is released, then the new set speed will be established.

To Decrease Speed

When the Electronic Speed Control is set, you can decrease speed by pushing the SET (-) button.

The driver's preferred units can be selected through the instrument panel settings if equipped. Refer to "Programmable Features" in "Understanding Your Instrument Panel" in the Owner's Manual on the DVD for more information. The speed decrement shown is dependant on the selected speed unit of U.S. (mph) or Metric (km/h):

U.S. Speed (mph)

- Pushing the SET (-) button once will result in a 1 mph decrease in set speed. Each subsequent tap of the button results in a decrease of 1 mph.
- If the button is continually pushed, the set speed will continue to decrease until the button is released, then the new set speed will be established.

Metric Speed (km/h)

- Pushing the SET (-) button once will result in a 1 km/h decrease in set speed. Each subsequent tap of the button results in a decrease of 1 km/h.
- If the button is continually pushed, the set speed will continue to decrease until the button is released, then the new set speed will be established.

To Accelerate For Passing

Push the accelerator as you would normally. When the pedal is released, the vehicle will return to the set speed.

NOTE:

If the accelerated speed goes above 10 mph (16 km/h) of the set speed, the Electronic Speed Control will deactivate.

OPERATING YOUR VEHICLE

LAUNCH MODE

This system maximizes acceleration traction for straight line racing.

1. Bring the vehicle to a complete stop on a level track surface with the engine running.
2. Set the steering wheel for straight ahead driving.
3. Fully depress the clutch and select the first gear position.
4. Push and release the “LAUNCH” button (located on the steering wheel controls).
5. Rapidly press the accelerator pedal to the floor within one second.

NOTE:

If the instrument cluster message indicates all conditions are correct for launch and the throttle is pressed to the floor quickly (within approximately 1/2 second) the system will hold the engine speed to a preset speed (below the engine rev limiter speed).

6. Release the clutch aggressively. Do not ride the clutch.

Release the accelerator pedal to deactivate launch control. Pushing the launch control button or actuating the brakes will also deactivate launch control.



LAUNCH Button

NOTE:

- Launch Mode brings the engine to optimum launch RPM and waits for the driver to release the clutch. Launch Mode then uses engine throttle only to achieve controlled wheelslip for maximum acceleration through first gear.
- Launch Mode can be used in any of the Electronic Stability Control (ESC) Modes.
- Launch Mode should not be used within the first 500 miles (805 km) of engine break-in.

WARNING!

Launch Mode is intended for off-highway or off-road use only and should not be used on any public roadways. It is recommended that this feature be used in a controlled environment, and within the limits of the law. The capabilities of the vehicle as measured by the performance pages must never be exploited in a reckless or dangerous manner, which can jeopardize the user's safety or the safety of others. Only a safe, attentive, and skillful driver can prevent accidents.

OPERATING YOUR VEHICLE

ELECTRONIC CONTROL DAMPING SYSTEM

This vehicle may be equipped with an Electronic Controlled Dampening system. This system reduces body roll and pitch in many driving situations including cornering, acceleration and braking.

This system allows for a street suspension damping setting or a firmer race suspension damping setting. There are two modes of operation:

STREET MODE

- This mode will give a sporty, but comfortable ride.
- This mode is driver selectable when the vehicle is placed in STREET mode (push the “STREET” button on the Instrument Panel).

NOTE:

The suspension mode will lock and stay in whatever the driver selects even when the ignition is turned off and the vehicle re-started.

- This mode is intended for a smoother ride on the various types of pavement and road conditions while still providing damping levels appropriate extreme capabilities.

RACE MODE

- Race mode is driver selectable when the vehicle is placed in RACE mode (push the “RACE” button on the Instrument Panel).
- This mode is for track use only and will supply maximum grip to the tires.
- When RACE mode is enabled, a shock symbol with “RACE” next to it will light up in the instrument cluster.

NOTE:

The RACE setting will provide a firmer ride.



Mode Buttons

- 1 — RACE Button
- 2 — STREET Button

OPERATING YOUR VEHICLE

ELECTRONIC STABILITY CONTROL (ESC)

The ESC corrects for oversteering and understeering the vehicle by applying the brake of the appropriate wheel. Engine power may also be reduced to assist in counteracting the condition of oversteer or understeer and help the vehicle maintain the desired path.

In full on mode ESC utilizes sensors in the vehicle to determine the path that the driver intends to steer the vehicle and compares it to the actual path of the vehicle. When the actual path does not match the intended path, the ESC applies the brake of the appropriate wheel to assist in counteracting the condition of oversteer or understeer.

Electronic Stability Control (ESC) Operating Modes

The ESC system may have five available operating modes:

ESC On

This is the normal operating mode for the ESC system. Whenever the vehicle is started, the ESC system will be in this mode. The ESC On mode should be used for most driving situations. The ESC should only be turned OFF for specific reasons as noted in the following paragraphs.

ESC Full Off

The ESC Off mode is intended for off-highway or off-road use only and should not be used on any public roadways. In this mode, all TCS and ESC stability features are turned OFF. To enter the "Full Off" mode, push and hold the "ESC" switch for five seconds while the vehicle is stopped with the engine running. After five seconds, a chime will sound, the "ESC Activation/Malfunction Indicator Light" will illuminate, and the "ESC OFF" message will display in the vehicle cluster (left of the odometer). The "ESC OFF" message may appear in the instrument cluster display. To turn ESC ON again, momentarily push the "ESC" switch.

Sport Mode

Sport mode has reduced traction control and reduced stability control. To enter the "Sport Mode" mode, push the "ESC" switch once (located on the steering wheel). The "ESC SPORT" light will illuminate, and the "ESC SPORT" message will display in the vehicle cluster (left of the odometer).

Track Mode

Track Mode has no traction control and has reduced stability control. To enter the "Track Mode" mode, push the "ESC" switch twice. The "ESC TRACK" light will illuminate, and the "ESC TRACK" message will display in the vehicle cluster (left of the odometer).

Rain Mode

Rain mode offers increased traction control and stability control for low traction conditions such as wet roads, dry roads during cold temperatures, or when the driver wants enhanced stability due to lack of familiarity or experience with the vehicle's response. To enter the "Rain Mode" mode, push the "ESC" switch three times. The "ESC RAIN" light will illuminate, and the "ESC RAIN" message will display in the vehicle cluster (left of the odometer).

NOTE:

Some models may not offer "Sport" or "Track" Mode.

WARNING!

The Electronic Stability Control System (ESC) cannot prevent the natural laws of physics from acting on the vehicle, nor can it increase the traction afforded by prevailing road conditions. ESC cannot prevent all accidents, including those resulting from excessive speed in turns, driving on very slippery surfaces, or hydroplaning. ESC also cannot prevent accidents resulting from loss of vehicle control due to inappropriate driver input for the conditions. Only a safe, attentive, and skillful driver can prevent accidents. The capabilities of an ESC equipped vehicle must never be exploited in a reckless or dangerous manner which could jeopardize the user's safety or the safety of others.

MANUAL TRANSMISSION 1 TO 4 SKIP SHIFT

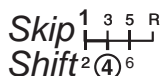

Skip Shift is enabled when vehicle speed is greater than 16 mph (26 km/h) but less than 18 mph (29 km/h) and the accelerator is at 20% or less.

For optimal fuel economy, under low acceleration conditions, your vehicle will only allow you to shift from first gear to fourth gear. Additionally, the skip shift message will appear in the tachometer.

OPERATING YOUR VEHICLE

AUTOMATIC TEMPERATURE CONTROL (ATC)



Automatic Climate Controls Touchscreen

- | | |
|------------------------------|--------------------------------------|
| 1 — MAX A/C Button | 7 — Mode Control Buttons |
| 2 — A/C Button | 8 — Blower Control Buttons |
| 3 — Air Recirculation Button | 9 — OFF Button |
| 4 — AUTO Button | 10 — Temperature Control Down Button |
| 5 — Front Defroster Button | 11 — Temperature Control Up Button |
| 6 — Rear Defroster Button | |

OPERATING YOUR VEHICLE



Climate Control Knobs

- | | |
|-------------------------------------|------------------------------|
| 1 — A/C Button | 6 — Front Defroster Button |
| 2 — Temperature Control Down Button | 7 — Rear Defroster Button |
| 3 — OFF Button | 8 — AUTO Button |
| 4 — Blower Control Knob | 9 — Air Recirculation Button |
| 5 — Temperature Control Up Button | |

- Press the AUTO button on the faceplate or the AUTO button on the touchscreen.
- Select the desired temperature by pushing the up or down temperature buttons.
- The system will maintain the set temperature automatically.

NOTE:

At Wide Open Throttle (WOT) the A/C will momentarily shut Off.

OPERATING YOUR VEHICLE

Air Conditioning (A/C)

- If the air conditioning button is pressed while in AUTO mode, the system will exit AUTO mode and stay in A/C. The mode and blower will be set at the closest mode and blower position that the system was operating in AUTO.

Air Recirculation / Max A/C

- Rotate the Temperature Control to the MAX A/C position to automatically turn on both Air Conditioning and Recirculation.
- For window defogging, turn the recirculation button off.
- Recirculation is not allowed in defrost/floor (mix) modes for approximately five minutes. Recirculation is allowed in floor mode.

PARKVIEW REAR BACK UP CAMERA

Your vehicle may be equipped with the ParkView Rear Back Up Camera that allows you to see an on-screen image of the rear surroundings of your vehicle whenever the gear selector is put into REVERSE. The ParkView camera is located on the rear of the vehicle above the rear license plate. The image will be displayed in the touchscreen display along with a caution note to “check entire surroundings” across the top of the screen. After five seconds this note will disappear.

NOTE:

The ParkView Rear Back Up Camera has programmable modes of operation that may be selected through the Uconnect System. Refer to “Uconnect Settings” in “Understanding Your Instrument Panel” in the Owner’s Manual on the DVD for further information.

If your vehicle is equipped with the Camera Delay feature and it is turned ON, the rear camera image will be displayed for up to 10 seconds when the vehicle is shifted out of REVERSE unless the forward vehicle speed exceeds 8 mph (13 km/h), the transmission is shifted into "PARK" or the vehicle's ignition is cycled to the OFF position.

When the Vehicle is shifted out of REVERSE (with camera delay turned OFF) the rear camera mode is exited and the last touchscreen appears again.

OPERATING YOUR VEHICLE

The active guide lines are overlaid on the image to illustrate the width of the vehicle and its projected backup path based on the steering wheel position.

Different colored zones indicate the distance to the rear of the vehicle.

WARNING!

Drivers must be careful when backing up even when using the ParkView Rear Back Up Camera. Always check carefully behind your vehicle, and be sure to check for pedestrians, animals, other vehicles, obstructions, or blind spots before backing up. You are responsible for the safety of your surroundings and must continue to pay attention while backing up. Failure to do so can result in serious injury or death.

CAUTION!

- To avoid vehicle damage, ParkView should only be used as a parking aid. The ParkView camera is unable to view every obstacle or object in your drive path.
- To avoid vehicle damage, the vehicle must be driven slowly when using ParkView to be able to stop in time when an obstacle is seen. It is recommended that the driver look frequently over his/her shoulder when using ParkView.

NOTE:

If snow, ice, mud, or any foreign substance builds up on the camera lens, clean the lens, rinse with water, and dry with a soft cloth. Do not cover the lens.



YOUR VEHICLE'S SOUND SYSTEM

1. Uconnect Voice Command (ⓂVR Button pg. 93
2. Uconnect Phone (📞 Button pg. 111
3. Steering Wheel Audio Controls (Left) pg. 120
4. Steering Wheel Audio Controls (Right) pg. 120
5. Volume Knob — Audio Mute Button
6. Screen Off Button



- 7. Back Button
- 8. Tune/Scroll Knob — Browse/Enter Button
- 9. Uconnect 8.4 Radio pg. 67
- 10. Power Outlet
- 11. USB Port pg. 86
- 12. SD Card Slot pg. 86
- 13. Aux Jack pg. 86

CYBERSECURITY

Your vehicle may be a connected vehicle and may be equipped with both wired and wireless networks. These networks allow your vehicle to send and receive information. This information allows systems and features in your vehicle to function properly.

Your vehicle may be equipped with certain security features to reduce the risk of unauthorized and unlawful access to vehicle systems and wireless communications. Vehicle software technology continues to evolve over time and FCA US LLC, working with its suppliers, evaluates and takes appropriate steps as needed. Similar to a computer or other devices, your vehicle may require software updates to improve the usability and performance of your systems or to reduce the potential risk of unauthorized and unlawful access to your vehicle systems.

The risk of unauthorized and unlawful access to your vehicle systems may still exist, even if the most recent version of vehicle software (such as Uconnect software) is installed.

WARNING!

- It is not possible to know or to predict all of the possible outcomes if your vehicle's systems are breached. It may be possible that vehicle systems, including safety related systems, could be impaired or a loss of vehicle control could occur that may result in an accident involving serious injury or death.
- ONLY insert media (e.g., USB, SD card, or CD) into your vehicle if it came from a trusted source. Media of unknown origin could possibly contain malicious software, and if installed in your vehicle, it may increase the possibility for vehicle systems to be breached.
- As always, if you experience unusual vehicle behavior, take your vehicle to your nearest authorized dealer immediately.

NOTE:

- FCA or your dealer may contact you directly regarding software updates.
- To help further improve vehicle security and minimize the potential risk of a security breach, vehicle owners should:
 - Routinely check www.driveuconnect.com/software-update to learn about available Uconnect software updates.
 - Only connect and use trusted media devices (e.g. personal mobile phones, USBs, CDs).

Privacy of any wireless and wired communications cannot be assured. Third parties may unlawfully intercept information and private communications without your consent. For further information, refer to "Privacy Practices – If Equipped with Uconnect 8.4 radio" in "All About Uconnect Access" in your Uconnect Owner's Manual Supplement and "Onboard Diagnostic System (OBD II) Cybersecurity" in your Owner's Manual.

YOUR RADIO

Uconnect 8.4 NAV

- 8.4" Touchscreen
- Navigation with 3D City and Terrain Modeling Standard
- HD Button will be visible on right side of screen when viewing AM or FM (U.S. Market Only)
- SiriusXM Travel Link feature listed within Apps



Uconnect 8.4 NAV

UCONNECT ACCESS

Uconnect Access — If Equipped (U.S. Residents Only)

WARNING!

- ALWAYS obey traffic laws and pay attention to the road. Some Uconnect Access services, including 9-1-1 and Assist, will NOT work without an operable 1X (voice/data) or 3G (data) network connection.
- ALWAYS drive safely with your hands on the steering wheel. You have full responsibility and assume all risks related to the use of the Uconnect features and applications in this vehicle. Only use Uconnect when it is safe to do so. Failure to do so may result in an accident involving serious injury or death.

NOTE:

Your vehicle may be transmitting data as authorized by the subscriber.

Uconnect Access enhances your ownership and driving experience by connecting your vehicle to an operable 1X (voice/data) or 3G (data) network. When connected to an operable 1X (voice/data) or 3G (data) network, you can:

- Place a call to a local 9-1-1 Operator for emergency assistance.
- Remotely lock/unlock your doors and start your vehicle from virtually anywhere, using the Uconnect Access App from your device. You can also do so by logging into Mopar Owner Connect, or by calling Uconnect Care when your vehicle has an operable 1X (voice/data) or 3G (data) network connection. Services can only be used where coverage is available; see coverage map for details.
- Turn your vehicle into a WiFi Hotspot and connect your devices to the internet.
- Receive text or email notifications if your vehicle's theft alarm goes off.
- Receive stolen vehicle assistance, using GPS technology to help authorities locate your vehicle if it is stolen.
- Listen to your text messages or send free-form text messages with your voice while keeping your hands on the wheel, using the Voice Texting feature. Requires a device that supports Bluetooth Message Access Profile (MAP).
- Search for places to eat, shop, relax and play with Yelp, using your voice or on-screen menu. Then navigate to them (navigation standard on Uconnect 8.4AN).
- Get operator assistance using the ASSIST button on your interior rearview mirror.

Before you drive, familiarize yourself with the easy-to-use Uconnect Access.

1. The ASSIST and 9-1-1 buttons are located on your rearview mirror. The ASSIST button is used for contacting Roadside Assistance, Vehicle Care and Uconnect Care. The 9-1-1 button connects you to emergency services.

NOTE:

- **Vehicles sold in Canada and Mexico DO NOT have 9-1-1 call system capabilities. 9-1-1 or other emergency line operators in Canada and Mexico may not answer or respond to 9-1-1 system calls.**
 - **Vehicles sold in Canada and Mexico DO NOT have Assist call system capabilities.**
2. The Uconnect “Apps  ” button on the touchscreen. This is where you can begin your registration process, manage your Apps and purchase WiFi on demand.
 3. The Uconnect Voice Command and Uconnect Phone buttons are located on the left side of your steering wheel. These buttons let you use your voice to give commands, make phone calls, send and receive text messages hands-free, enter navigation destinations, and control your radio and media devices.

Included Trial Period For New Vehicles

Your new vehicle may come with an included trial period for use of the Uconnect Access Services starting at the date of vehicle purchase (date based on vehicle sales notification from your dealer). **To activate the trial, you must first register with Uconnect Access.** After the trial period, if you wish to continue your Uconnect Access Services you can choose to purchase a subscription.

Features And Packages

- After the trial period, you can subscribe to continue your service by visiting the Uconnect Store located within the Mopar Owner Connect website moparownerconnect.com. If you need assistance, U.S. residents can call Uconnect Care at 1-855-792-4241 .
- For the latest information on packages and pricing information: U.S. residents visit DriveUconnect.com.

Uconnect Access Registration (U.S. 48 Contiguous States, Alaska And Hawaii)

To unlock the full potential of Uconnect Access in your vehicle, you first need to register with Uconnect Access.

1. Push the ASSIST button on your rearview mirror.
2. Press the “Uconnect Care” button on the touchscreen.
3. A helpful Uconnect Care Agent will register your vehicle and handle all of the details.

Signing up is easy! Simply follow the steps above. Or, press the “Apps  ” button on the touchscreen, then select the Uconnect registration app to “Register By Web” and complete the process using your device or computer.



ASSIST Button

Why sign up for Uconnect Access? Here are just a few examples of things you'll be able to do:

- Know that help, if you need it, is only a button press away.
- Lock and unlock your vehicle doors from hundreds of miles away.
- Discover great, new places around you using Yelp.
- Dictate and send text messages by speaking out loud (all while keeping both hands on the wheel!!)
- Enjoy the best in music and entertainment from around the world with apps like Pandora.

For further information please visit DriveUconnect.com.

Download The Uconnect Access App

You're only a few steps away from using remote commands and playing your favorite music in your vehicle.

To link your internet radio accounts:

1. Download the **Uconnect Access App** on your device.
2. Press the Via Mobile icon on the navigation bar at the bottom of the app.
3. Press the app you'd like to connect to your vehicle.
4. Enter your login information for the selected app and press Link.
5. Next time you're in your vehicle, enable Bluetooth, pair your device and select the Via Mobile app you want to play from the Uconnect touchscreen to stream your personalized music.



Mobile App

NOTE:

- You can also complete this process on the web. Simply visit moparownerconnect.com log in and click **Set Up Via Mobile Profile** (under Quick Links).
- Once you download the app to your compatible device, you will also be able to lock/unlock its doors from virtually anywhere.

Via Mobile Apps — If Equipped

- **Aha by HARMAN** — Aha by HARMAN makes it easy to instantly access your favorite Web content on the go. Choose from over 40,000+ stations spanning internet radio, personalized music, news, entertainment, hotels, weather, audiobooks, Facebook, Twitter, and more.
- **iHeartRadio** — iHeartRadio provides instant access to more than 1,500 live radio stations from across the country and allows listeners to create custom music stations inspired by their favorite artists or songs.
- **Pandora** — Pandora gives people the music and comedy they love anytime, anywhere. Personalized stations launch instantly, with the input of a favorite artist, track, comedian, or genre.

- **Slacker Radio** — Enjoy millions of songs and hundreds of handcrafted stations.

NOTE:

For detailed information on how to use Via Mobile apps visit the Mopar Owner Connect website (moparownerconnect.com) and log in using the username and password you set up when registering for Uconnect Access.

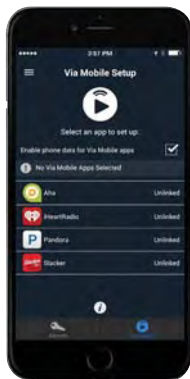

Via Mobile

Renewing Subscriptions And Purchasing 3G Wi-Fi Hotspot (U.S. 48 Contiguous States, Alaska And Hawaii)

Subscriptions, and 3G Wi-Fi Hotspot, can be purchased from the Uconnect Store within your vehicle, and online at Mopar Owner Connect. If you need help push the ASSIST button on the rearview mirror, then select Uconnect Care (or dial 1-855-792-4241).

NOTE:

You must set up a Uconnect Access Payment Account online (log in to moparownerconnect.com, go to Edit Profile, then Uconnect Payment Account, to set up and manage your Payment Account).

Getting Started With Apps

Applications (Apps for short) in your Uconnect Access system are designed to deliver the features and services that you want. There are two basic categories:

1. **Built-In Features** — use the 1X (voice/data) or 3G (data) network on your 8.4 NAV radio.
2. **Uconnect Access Via Mobile** — use the Uconnect Access App and your device's data plan to access your personal Pandora, iHeartRadio, Aha and Slacker accounts from the vehicle and control them using the touchscreen. Customer's data plan charges will apply. Available on Uconnect 8.4 NAV Radios.

Apps Main Menu

Press the “Apps ” button on the touchscreen to open the Apps main menu, in this screen you will be able to access all of your available Apps. To access an App directly, press the corresponding button on the touchscreen and you will be directed to that App. To view the rest our your Apps, press the page forward or page back button.



Uconnect Apps

1 — Apps Button

2 — Page Back Button

App Manager

Press the “App Manager” button to access the following categories:

Favorite Apps — This is the default screen when you first press the “App Manager” button on the touchscreen, and is a good place to put the apps you use most frequently. To make an App a “favorite”, press the “Settings” button on the touchscreen to the right of the App.

All Apps — All of your available Apps will reside in the “All Apps” folder.

Running Apps — Press this tab to see which apps are currently running.

Maintaining Your Uconnect Access Account

Selling Your Vehicle

When you sell your vehicle, we recommend that you remove your Uconnect Access Account information from the vehicle. You can do this on the Mopar Owner Connect website (moparownerconnect.com). Removing your account information cancels your subscription and makes your vehicle factory-ready for a new owner/subscriber.

For additional information on Uconnect:

- U.S. residents - visit DriveUconnect.com or call 1-877-855-8400 (24 hours a day 7 days a week).
- Canadian Residents - visit DriveUconnect.ca or call, 1-800-465-2001 (English) or 1-800-387-9983 (French).

Mon. – Fri., 8:00 am – 8:00 pm, ET

Sat., 9:00 am – 5:00 pm, ET

Sun., Closed

Built-In Features

WARNING!

- ALWAYS obey traffic laws and pay attention to the road. Some Uconnect Access services, including 9-1-1 and Assist, will NOT work without an operable 1X (voice/data) or 3G (data) network connection.
- ALWAYS drive safely with your hands on the steering wheel. You have full responsibility and assume all risks related to the use of the Uconnect features and applications in this vehicle. Only use Uconnect when it is safe to do so. Failure to do so may result in an accident involving serious injury or death.
- Ignoring the rearview mirror light could mean you may not have 9-1-1 Call service if needed. If the rearview mirror light is illuminated, have an authorized dealer service the 9-1-1 Call system immediately.
- The Occupant Restraint Controller (ORC) turns on the Air Bag Warning Light on the instrument panel if a malfunction is detected in any part of the airbag system. If the Air Bag Warning Light is illuminated, the air bag system may not be working properly and the 9-1-1 system may not send a signal to a 9-1-1 operator if an air bag is deployed. If the Air Bag Warning Light is illuminated, have an authorized dealer service your vehicle immediately.
- If anyone in the vehicle could be in danger (e.g., fire or smoke is visible, dangerous road conditions or location), do not wait for voice contact from a 9-1-1 operator. All occupants should exit the vehicle immediately and move to a safe location.

WARNING!

- The 9-1-1 Call system is embedded into the vehicle's electrical system. Do not add aftermarket electrical equipment to the vehicle's electrical system. This may prevent your vehicle from sending a signal to initiate an emergency call. To avoid interference that can cause the 9-1-1 Call system to fail, never add aftermarket equipment (e.g., two-way mobile radio, CB radio, data recorder, etc.) to your vehicle's electrical system or modify the antennas on your vehicle.
- IF YOUR VEHICLE LOSES BATTERY POWER FOR ANY REASON (INCLUDING DURING OR AFTER AN ACCIDENT), the Uconnect features, apps and services, among others, will not operate.

NOTE:

Your vehicle may be transmitting data as authorized by the subscriber.

1. **Assist Call (8.4AN)** — The rearview mirror contains an ASSIST push button which automatically connects the vehicle occupants to one of these predefined destinations for immediate support:

- **Roadside Assistance Call** — If you get a flat tire, or need a tow, you'll be connected to someone who can help anytime. Additional fees may apply. Additional information in this section.
- **Uconnect Access Care** — In vehicle support for Uconnect Access System, Apps and Features.
- **Vehicle Care** — Total support for your FCA US LLC vehicle.



ASSIST/9-1-1 Buttons

2. **Emergency 9-1-1 Call (If Equipped)** — The rearview mirror contains a 9-1-1 button that, when pressed, may place a call from your vehicle to a local 9-1-1 operator to request help from local police, fire or ambulance personnel. If this button is accidentally pressed, you will have 10 seconds to stop the call. To cancel, press the 9-1-1 Call button again or press the "Cancel" button shown on the touchscreen. After 10 seconds has passed, the 9-1-1 call will be placed and only the 9-1-1 operator can cancel it. The LED light on the rearview mirror will turn green once a connection to a 9-1-1 operator has been made. The green LED light will turn off once the 9-1-1 call is terminated. Have an authorized dealer service the vehicle if the rearview mirror light is continuously red. On equipped vehicles, this feature requires a functioning electrical system and an operable 1X (voice/data) or 3G (data) network connection to function properly. **If a connection is made between a 9-1-1 operator and your vehicle, you understand and agree that 9-1-1 operators may, like any other 9-1-1 call, record conversations and sounds in and near your vehicle upon connection.**

3. **Roadside Assistance (If Equipped)** — If your vehicle is equipped with this feature and has an operable 1X (voice/data) or 3G (data) network connection, you may be able to connect with Roadside Assistance by pressing the "ASSIST" button on the rearview mirror. You will be presented with Assist Care options. Make a selection by pressing the prompts displayed on the radio. If Roadside Assistance is provided to your vehicle, you agree to be responsible for any additional roadside assistance service costs that you may incur. In order to provide Uconnect Services to you, we may record and monitor your conversations with Roadside Assistance, Uconnect Care or Vehicle Care, whether such conversations are initiated through the Uconnect Services in your vehicle, your device or via a landline device, and may share information obtained through such recording and monitoring in accordance with regulatory requirements. You acknowledge, agree and consent to any recording, monitoring or sharing of information obtained through any such call recordings.
4. **Yelp** — Customers have the ability to search for nearby destinations or a point of interest (POI) either by category or custom search by using keywords (for example, "Italian restaurant"). Searching can be done by either voice or by using the touch-screen keypad. Using the touchscreen, launch Yelp by selecting the "Apps" icon. Press the "All Apps" tab, and then press "Yelp." To use voice recognition, push the VR button on the steering wheel and say "launch Yelp," then follow the instructions on the Teleprompter.
5. **Security Alarm Notification** — The Security Alarm Notification feature notifies you via email or text (SMS) message when the vehicle's factory-installed security alarm system has been set-off. There are a number of reasons why your alarm may have been triggered, one of which could be that your vehicle was stolen. If so, please see the details of the Stolen Vehicle Assistance service below. When you register, Security Alarm Notification is automatically set to send you an email at the mail address you provide should the alarm go off. You may also opt to have a text message sent to your device.
6. **Stolen Vehicle Assistance** — If your vehicle is stolen, contact local law enforcement immediately to file a stolen vehicle report. Once this report has been filed, Uconnect care can help locate your vehicle. The Uconnect Care agent will ask for the stolen vehicle report number issued by local law enforcement. Then, using GPS technology and the built-in wireless connection within your vehicle, the Uconnect Care agent will be able to locate the stolen vehicle and work with law enforcement to help recover it. Your vehicle must be within the United States, have network coverage and must be registered with Uconnect Access with an active subscription that includes the applicable feature.
7. **3G Wi-Fi Hotspot** — 3G Wi-Fi Hotspot is an in-vehicle feature that connects your device to an operable 1X (voice/data) or 3G (data) network using Uconnect Access and is ready to go where ever you are. Once your vehicle is registered for Uconnect Access, you can purchase a Wifi Hotspot subscription at the Uconnect Store. After you've made your purchase, turn on your signal and connect your passengers devices. It's never been easier to bring your home or office with you.

WARNING!

NEVER use the 3G Wi-Fi Hotspot when you are driving the vehicle. As the driver, you should only use the 3G Wi-Fi Hotspot when the vehicle is parked in a safe location. Failure to do so may result in an accident involving serious injury or death.

NOTE:

Your vehicle must have a working electrical system for any of the in vehicle Uconnect features to operate.

Uconnect Access Remote Features

If you own a compatible iPhone or Android powered device, the Uconnect Access App allows you to remotely lock or unlock your doors or activate your horn and lights from virtually anywhere. Your vehicle must have an operable 1X (voice/data) or 3G (data) network connection. Services can only be used where coverage is available; see coverage map for details. You can download the App from Mopar Owner Connect or from the App Store (iPhone) or Google Play store. Visit UconnectPhone.com to determine if your device is compatible. For Uconnect Phone customer support and to determine if your device is compatible.

U.S. residents - visit UconnectPhone.com or call 1-877-855-8400

Remote Door Lock/Unlock — This feature provides the ability to lock or unlock the door on your vehicle, without the keys and from virtually any distance. You can send a request to your vehicle in one of three ways:

1. Using the Uconnect Access App from a compatible device.
2. From the Mopar Owner Connect website.
3. By contacting the Uconnect Care on the phone.

To use this feature after the Uconnect Access App is downloaded, login using your user name and password. You will need your four digit Uconnect Security PIN to confirm the request. Press the “closed lock” icon on your Uconnect Access App to lock the doors, and press the “open Lock” icon to unlock the driver’s door.

You can set-up notifications for your account to receive an email or text (SMS) message every time a command is sent. Login to Mopar Owner Connect (moparownerconnect.com) and click on Edit Profile to manage Uconnect Notifications.

Remote Horn And Lights — It's easy to locate a vehicle in a dark, crowded or noisy parking area by activating the horn and lights. It may also help if you need to draw attention to your vehicle for any reason. You can send a request to your vehicle in one of three ways:

1. Using the Uconnect Access App from a compatible device.
2. From the Mopar Owner Connect website.
3. By contacting the Uconnect Care on the phone.

To use this feature after the Uconnect Access App is downloaded, login using your user name and password. You will need your four digit Uconnect Security PIN to confirm the request. You can set-up notifications for your account to receive an email or text (SMS) message every time a command is sent. Login to Mopar Owner Connect (moparownerconnect.com) and click on Edit Profile to manage Uconnect Notifications.

Voice Texting — Want to dictate a personal message? Register with Uconnect Access to take advantage of a new, cloudbased Voice Texting service, an enhancement to Voice Text Reply.

Voice Texting allows you to compose a new text or reply to an incoming text message. Before you attempt to use the Voice Texting feature, check to ensure you have the following:

1. A paired, Bluetooth enabled device with the Message Access Profile (MAP). Not all Bluetooth enabled devices support MAP, including all iPhones (Apple iOS). Visit UconnectPhone.com for system and device compatibility information.
2. An active Uconnect Access trial or paid subscription. Press the “Apps  ” button on the touchscreen to begin the registration process.
3. Accept the “Allow MAP” profile request on your device. (Please refer to device manufacturer instructions for details).

To Send A Text Message:

1. Push the Uconnect Phone Button  on the steering wheel.
2. Wait for the beep.
3. Say “Text.”
4. Uconnect will prompt you “Say the phone number, or full name and phone type of the contact you want to send a message to.”

5. Wait for the beep and say a contact that is in your phonebook, or a mobile phone number that you would like to send the message to.
6. Uconnect will prompt you "Please say the message that you would like to send." (If you do not hear this prompt, you may not have an active subscription with Uconnect Access).
7. Wait for the beep, and then dictate any message up to 140 characters. If you exceed 140 characters, you will hear the following prompt: "Message was too long; your message will be truncated."
8. Uconnect will then repeat the message back to you.
9. Uconnect will prompt you: "To add to your message, say "Continue"; To delete the current message and start over, say "Start Over"; to send the current message, say "Send"; to hear the message again, say "Repeat".
10. If you are happy with your message and would like to send it, wait for the beep and say "Send".
11. Uconnect will then say "Sending your message."

Sample Commands For Voice Text Reply And Voice Texting

Example Command	Action
"Text John Smith"	Send a message to specific contact in address book
"Text 123 456 7890"	Send 123 456 7890 a message from your phonebook
"Show messages"	See recent text messages listed by number on Uconnect screen
"Listen to/view (message number four, for example)"	Hear messages or read it on Uconnect screen
"Reply"	Send a voice text reply to a current message
"Forward text/message to "John Smith"	Forward current text to specific contact in address book
"Forward text/message to "123 456 7890"	Forward current text to specific phone number

UCONNECT 8.4 NAV

Uconnect 8.4 NAV AT A GLANCE



Uconnect 8.4 NAV Radio Screen

CAUTION!

Do NOT attach any object to the touchscreen, doing so can result in damage to the screen.

Setting The Time

- Model 8.4 NAV synchronizes time automatically via GPS, so it should not require any time adjustment. If you do need to set the time manually, follow the instructions below.
- If the time is not displayed at the top of the screen, press the “Apps” button then the “Settings” button on the touchscreen. In the Settings screen, press the “Clock” button on the touchscreen, then check or uncheck this option.
- Press “+” or “-” next to Set Time Hours and Set Time Minutes to adjust the time.
- If these features are not available, uncheck the Sync Time box.

Background Themes

- Screen background themes are selectable from a pre-loaded list of themes. If you'd like to set a theme, follow the instructions below.
- Press the “Settings” button on the touchscreen.

- Press the “Display” button on the touchscreen.
- Then press “Set Theme” button on the touchscreen and select a theme.

Audio Settings

Press the “Settings” button, then “Audio” button on the touchscreen to Adjust the settings below:

Balance/Fade

- Press the “Balance/Fade” button on the touchscreen to Balance audio between the front speakers or fade the audio between the rear and front speakers.
- Pressing the “Front,” “Rear,” “Left,” or “Right” buttons on the touchscreen or press and drag the Speaker Icon to adjust the Balance/Fade.

Equalizer

- Press the “Equalizer” button on the touchscreen to activate the Equalizer screen.
- Press the “+” or “-” buttons on the touchscreen, or press and drag over the level bar for each of the equalizer bands. The level value, which spans between plus or minus 9, is displayed at the bottom of each of the Bands.

Speed Adjusted Volume

- Press the “Speed Adjusted Volume” button on the touchscreen to activate the Speed Adjusted Volume screen. The Speed Adjusted Volume is adjusted by pressing the volume level indicator. This alters the automatic adjustment of the audio volume with variation to vehicle speed.

Surround Sound

- Press the “Surround Sound” button on the touchscreen, select On or Off followed by pressing the “arrow back” button on the touchscreen. When this feature is activated, it provides simulated surround sound mode.

Aux Volume Offset

- Press the “Aux Volume Offset” button on the touchscreen and choose a level from -3 to +3.

PERSONALIZED MENU BAR

The Uconnect features and services in the main menu bar are easily changed for your convenience. Simply follow these steps:



Uconnect 8.4 NAV Main Menu

1. Press the “Apps ” button to open the App screen.
2. Press and hold, then drag the selected App to replace an existing shortcut in the main menu bar.
3. The replaced shortcut will now be an active App/shortcut on the main menu bar.

RADIO



Uconnect 8.4 NAV Radio

- | | |
|-------------------------------|------------------------------------|
| 1 — Radio Station Presets | 7 — Audio Settings |
| 2 — Toggle Between Presets | 8 — Seek Up |
| 3 — Status Bar | 9 — Direct Tune To A Radio Station |
| 4 — View Small Navigation Map | 10 — Seek Down |
| 5 — HD Radio | 11 — Browse And Manage Presets |
| 6 — Main Category Bar | 12 — Radio Bands |

- To access the Radio mode, press the “Radio” button on the touchscreen at the lower left of the screen.

Selecting Radio Stations

- Press the desired radio band (AM, FM or SXM) button on the touchscreen.

Seek Up/Seek Down

- Press the Seek up or down arrow buttons on the touchscreen for less than two seconds to seek through radio stations.
- Press and hold either arrow button on the touchscreen for more than two seconds to bypass stations without stopping. The radio will stop at the next listenable station once the arrow button on the touchscreen is released.

Direct Tune

- Tune directly to a radio station by pressing the “Tune” button on the screen, and entering the desired station number.

Store Radio Presets Manually

Your radio can store 36 total preset stations, 12 presets per band (AM, FM and SXM). They are shown at the top of your radio screen. To see the 12 preset stations per band, press the arrow button on the touchscreen at the top right of the screen to toggle between the two sets of six presets.

To store a radio preset manually, follow the steps below:

1. Tune to the desired station.
2. Press and hold the desired numbered button on the touchscreen for more than two seconds or until you hear a confirmation beep.

HD Radio

- HD Radio operates similar to conventional radio except it allows broadcasters to transmit a high-quality digital signal.
- With an HD radio receiver, the listener is provided with a clear sound that enhances the listening experience. HD radio can also transmit data such as song title or artist.

SiriusXM PREMIER OVER 160 CHANNELS

Get every channel available on your satellite radio, and enjoy all you want, all in one place. Hear commercial-free music plus sports, news, talk and entertainment. Get all the premium programming, including Howard Stern, every NFL game, Oprah Radio, every MLB and NHL game, every NASCAR race, Martha Stewart and more. And get 20+ extra channels, including SiriusXM Latino, offering 20 channels of commercial free music, news, talk, comedy, sports and more dedicated to Spanish language programming.

- To access SiriusXM Satellite Radio, press the “SXM” button on the touchscreen on the main Radio screen.

The following describes features that are available when in SiriusXM Satellite Radio mode:

Seek Up/Seek Down

- Press the Seek arrow buttons on the touchscreen for less than two seconds to seek through channels in SXM mode.
- Press and hold either arrow button on the touchscreen for more than two seconds to bypass channels without stopping. The radio will stop at the next listenable channel once the arrow button on the touchscreen is released.

Direct Tune

- Tune directly to a SXM channel by pressing the “Tune” button on the touchscreen on the screen, and entering the desired station number.

Jump

- Automatically tells you when Traffic & Weather for a favorite city is available, and gives you the option to switch to that channel. Press “Jump” to activate the feature. After listening to Traffic and Weather, press “Jump” again to return to the previous channel.

Fav

- Activates the favorites menu. You can add up to 50 favorite artists or songs. Just press “Add Fav Artist” or “Add Fav Song” while the song is playing. You will then be alerted any time one of these songs, or works by these artists, is playing on other SiriusXM channels.

SiriusXM Parental Controls

- You can skip or hide certain channels from view if you do not want access to them. Press the “Apps” button on the touchscreen, then the “Settings” button on the touchscreen, next press the “Sirius Setup” button on the touchscreen, then select Channel Skip. Press the box check-mark next to the channel you want skipped. They will not show up in normal usage.
- SiriusXM also offers the option to permanently block selected channels. Call (1-888-601-6297 for U.S. customers, 1-877-438-9677 for Canadian customers) and request the Family-Friendly Package.

Browse

Lets you browse the SiriusXM channel listing or Genre listing. Favorites, Game Zone, Weather and Jump settings also provide a way to browse the SiriusXM channel list.

Browse Sub-Menu	Sub-Menu Description
All	Shows the channel listing.
Genre	Provides a list of all genres, and lets you jump to a channel within the selected genre.
Presets	Lets you scroll the list of Preset satellite channels. Press the channel, or press Enter on the Tune knob, to go to that channel. Press the trash can icon to delete a preset. Your presets are also shown at the top of the main Satellite Radio screen.
Favorites	Lets you manage artists and songs in the Favorites list and configure Alert Settings to let you know when favorite songs or artists are playing on other channels. Also, view a list of channels airing any of your Favorites.
Game Zone	Provides alerts when your favorite sports teams are starting a game which is being aired on other SiriusXM channels, or when their game score is announced. You can select and manage your Teams list here, and configure alerts.
Jump	Lets you select your favorite cities for Traffic & Weather information, which is used by the Jump feature on the main satellite radio screen.

Replay

Lets you replay up to 44 minutes of the content of the current SiriusXM channel.

Replay Option	Option Description
Play/Pause	Press to Pause content playback. Press Pause/Play again to resume playback.
Rewind/RW	Rewinds the channel content in steps of five seconds. Press and hold to rewind continuously, then release to begin playing content at that point.
Fast Forward/FW	Forwards the content, and works similarly to Rewind/RW. However, Fast Forward/FW can only be used when content has been previously rewound.
Replay Time	Displays the amount of time in the upper center of the screen by which your content lags the Live channel.
Live	Resumes playback of Live content at any time while replaying rewound content.

- SiriusXM services require subscriptions, sold separately after the 12-month trial included with the new vehicle purchase. **If you decide to continue your service at the end of your trial subscription, the plan you choose will automatically renew and bill at then-current rates until you call SiriusXM at 1-866-635-2349 for U.S. residents and 1-888-539-7474 for Canadian residents to cancel. See SiriusXM Customer Agreement for complete terms at www.siriusxm.com (US residents) or siriusxm.ca (Canadian residents).** All fees and programming subject to change. Our satellite service is available only to those at least 18 and older in the 48 contiguous USA and D.C. Our Sirius satellite service is also available in PR (with coverage limitations). Our Internet radio service is available throughout our satellite service area and in AK and HI. ©2016 Sirius XM Radio Inc. Sirius, XM and all related marks and logos are trademarks of Sirius XM Radio Inc.

MEDIA HUB — USB/MP3/SD CARD

There are many ways to play music from MP3 players, USB devices, or SD Cards through your vehicle's sound system. Press your Media button on the touchscreen to begin.

Audio Jack (AUX)

- The AUX allows a device to be plugged into the radio and utilize the vehicle's sound system, using a 3.5 mm audio cable, to amplify the source and play through the vehicle speakers.
- Pressing the "AUX" button on the touchscreen will change the mode to auxiliary device if the audio jack is connected, allowing the music from your device to be heard through the vehicle's speakers. To activate the AUX, plug in the audio jack.
- The functions of the device are controlled using the device buttons. The volume may be controlled using the radio or the device.

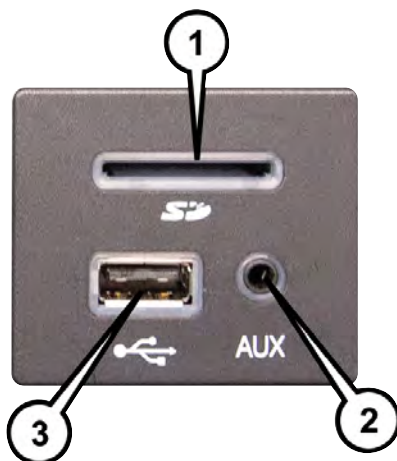

Uconnect Media Hub

- 1 — SD Card Slot
- 2 — AUX Jack
- 3 — USB Port

USB Port

- Connect your compatible device using a USB cable into the USB Port. USB Memory sticks with audio files can also be used. Audio from the device can be played on the vehicles sound system while providing metadata (artist, track title, album, etc.) information on the radio display.
- When connected, the compatible USB device can be controlled using the radio or Steering Wheel Audio Controls to play, skip to the next or previous track, browse, and list the contents.
- The battery charges when plugged into the USB port (if supported by the specific device).

NOTE:

When connecting your device for the first time, the system may take several minutes to read your music, depending on the number of files. For example, the system will take approximately five minutes for every 1,000 songs loaded on the device. Also during the reading process, the Shuffle and Browse functions will be disabled. This process is needed to ensure the full use of your features and only happens the first time it is connected. After the first time, the reading process of your device will take considerably less time unless changes are made or new songs are added to the playlist.

SD Card

- Play songs stored on an SD card inserted into the SD card slot.
- Song playback can be controlled using the radio or Steering Wheel Audio Controls to play, skip to the next or previous track, browse, and list the contents.

Bluetooth Streaming Audio

- If equipped with Uconnect Voice Command, your Bluetooth-equipped device may also be able to stream music to your vehicle's sound system. Your connected device must be Bluetooth-compatible and paired with your system (see Uconnect Phone for pairing instructions). You can access the music from your connected Bluetooth device by pressing the Bluetooth  button on the touchscreen while in Media mode.

USB/SD Card/AUX CONTROLS



USB/SD Card/AUX Controls

- | | |
|-----------------------------|--|
| 1 — Repeat Music Track | 5 — Show Songs Currently In Cue To Be Played |
| 2 — Music Track And Time | 6 — Browse Music By |
| 3 — Shuffle Music Tracks | 7 — Music Source |
| 4 — Music Track Information | |

The controls are accessed by pressing the desired button on the touchscreen and choosing between AUX, USB, Bluetooth or SD Card.

NOTE:

Uconnect will automatically switch to the appropriate mode when something is first connected or inserted into the system.

NAVIGATION

- Press the “Nav” button on the touchscreen in the menu bar to access the Navigation system.

Changing The Navigation Voice Prompt Volume

1. Press the “View Map” button on the touchscreen from the Nav Main Menu.
2. With the map displayed, press the “Settings” button on the touchscreen in the lower right area of the screen.
3. In the Settings menu, press the “Guidance” button on the touchscreen.
4. In the Guidance menu, adjust the Nav Volume by pressing the “+” or “-” buttons on the touchscreen.



Uconnect 8.4 NAV Navigation

- 1 — Find A Destination
- 2 — View Map
- 3 — Information
- 4 — Emergency

- 5 — Navigation Settings
- 6 — Stop A Route
- 7 — Detour A Route
- 8 — Repeat Route Guidance Prompt

Finding Points Of Interest

- From the main Navigation menu, press the “Where To?” button on the touchscreen, then press the “Points of Interest” button on the touchscreen.
- Select a Category and then a subcategory, if necessary.
- Select your destination and press the “Yes” button on the touchscreen.

Finding A Place By Spelling The Name

- From the Main Navigation Menu press the “Where to?” button on the touchscreen, press the “Points of Interest” button on the touchscreen, then press the “Spell Name” button on the touchscreen.
- Enter the name of your destination.
- Press the “List” button on the touchscreen.
- Select your destination and press the “Yes” button on the touchscreen.

One-Step Voice Destination Entry

- Enter a navigation destination without taking your hands off the wheel.
- Just press the Uconnect Voice Command  button on the steering wheel, wait for the beep and say something like, “**Find Address** 800 Chrysler Drive Auburn Hills MI.”

NOTE:

Destination entry is not available while your vehicle is in motion. However, you can also use Voice Commands to enter an address while moving. Refer to Common Navigation Voice Commands in the Uconnect Voice Command section.

Setting Your Home Location

- Press the “Nav” button on the touchscreen in the menu bar to access the Navigation system and the Main Navigation menu.
- Press the “Where To?” button on the touchscreen, then press the “Go Home” button on the touchscreen.
- You may enter your address directly, use your current location as your home address, or choose from recently found locations.
- To delete your Home location (or other saved locations) so you can save a new Home location, press the “Where To?” button on the touchscreen from the Main Navigation menu, then press the “Go Home” button on the touchscreen, and in the Yes screen press the “Options” button on the touchscreen. In the Options menu press the “Clear Home” button on the touchscreen. Set a new Home location by following the previous instructions.

Go Home

A Home location must be saved in the system.

- From the Main Navigation menu, press the “Where To?” button on the touchscreen, then press the “Go Home” button on the touchscreen.



Uconnect 8.4 NAV Map

- 1 — Distance To Next Turn
- 2 — Next Turn Street
- 3 — Estimated Time Of Arrival
- 4 — Zoom In And Out

- 5 — Your Location On The Map
- 6 — Navigation Main Menu
- 7 — Current Street Location
- 8 — Navigation Routing Options

Your route is marked with a blue line on the map. If you depart from the original route, your route is recalculated. A speed limit icon could appear as you travel on major roadways.

Adding A Stop

To add a stop you must be navigating a route.

- Press the “Menu” button on the touchscreen to return to the Main Navigation menu.
- Press the “Where To?” button on the touchscreen, then search for the extra stop. When another location has been selected, you can choose to cancel your previous route, add as the first destination or add as the last destination.
- Press the desired selection and press the “Yes” button on the touchscreen.

Taking A Detour

To take a detour you must be navigating a route.

- Press the “Detour” button on the touchscreen.

NOTE:

If the route you are currently taking is the only reasonable option, the device may not calculate a detour. For more information, see your Uconnect Owner's Manual Supplement.

SiriusXM TRAFFIC (US Market Only)

Don't Drive Through Traffic. Drive Around It.

Avoid congestion before you reach it. By enhancing your vehicle's navigation system with the ability to see detailed traffic information, you can pinpoint traffic incidents, determine average traffic speed and estimate travel time along your route. Since the service is integrated with a vehicle's navigation system, SiriusXM Traffic can help drivers pick the fastest route based on traffic conditions.

- Detailed information on traffic speed, accidents, construction, and road closings.
- Traffic information from multiple sources, including police and emergency services, cameras and road sensors.
- Coast-to-coast delivery of traffic information.
- View conditions for points along your route and beyond. Available in over 130 markets.

SiriusXM Travel Link (US Market Only)

In addition to delivering over 130 channels of the best sports, entertainment, talk, and commercial-free music, SiriusXM offers premium data services that work in conjunction with compatible navigation systems. SiriusXM Travel Link brings a wealth of useful information into your vehicle and right to your fingertips.

- **Fuel Prices** — Check local gas and diesel prices in your area and route to the station of your choice.
- **Movie Listings** — Check local movie theatres and listings in your area and route to the theater of your choice.
- **Sports Scores** — In-game and final scores as well as weekly schedules.
- **Weather** — Check variety of local and national weather information from radar maps to current and 5-day forecast.

SiriusXM Travel Link feature is completely integrated into your vehicle. A few minutes after you start your vehicle, Travel Link information arrives and updates in the background. You can access the information whenever you like, with no waiting.

To access SiriusXM Travel Link, press “Apps” button on the touchscreen, then press the “SiriusXM Travel Link” button on the touchscreen.

NOTE:

SiriusXM Travel Link requires a subscription, sold separately after the five (5) year trial subscription included with your vehicle purchase.

SiriusXM Travel Link is only available in the United States.

Fuel Prices	Check local gas and diesel prices in your area and route to the station of your choice.
Movie Listings	Check local movie theatres and listings in your area and route to the theater of your choice.
Sports Scores	In-game and final scores as well as weekly schedules.
Weather	Check variety of local and national weather information from radar maps to current and 5-day forecast.

UCONNECT 8.4 NAV VOICE RECOGNITION QUICK TIPS

Introducing Uconnect

Start using Uconnect Voice Recognition with these helpful quick tips. It provides the key Voice Commands and tips you need to know to control your Uconnect 8.4 NAV system.

You will see the  icon on your touchscreen with your Uconnect system.



Uconnect 8.4 NAV



Get Started

1. Visit UconnectPhone.com for mobile device and feature compatibility and to find phone pairing instructions.
2. Reduce background noise. Wind and passenger conversations are examples of noise that may impact recognition.
3. Speak clearly at a normal pace and volume while facing straight ahead. The microphone is positioned on the rearview mirror and aimed at the driver.
4. Each time you give a Voice Command, you must first push either the VR or Phone button, wait until **after** the beep, then say your Voice Command.
5. You can interrupt the help message or system prompts by pushing the VR or Phone button and saying a Voice Command from current category.

All you need to control your Uconnect system with your voice are the buttons on your steering wheel.



Uconnect VR/Phone Buttons

1. Uconnect Voice Recognition Button 
 - a. Short Press: **Push and release** VR button to begin Radio, Climate, Navigation, and other embedded functions. After you hear the single beep, say a command.
 - b. Long Press: **Push and hold** VR button then release for Siri functions. After you hear the familiar Siri "double beep," say a command.
2. Uconnect Phone Button  , Push to initiate, answer, or end a phone call, send or receive a text

Basic Voice Commands

The basic Voice Commands below can be given at any point while using your Uconnect system.

Push the VR button (Ⓜ️). After the beep, say:

- **Cancel** to stop a current voice session
- **Help** to hear a list of suggested Voice Commands
- **Repeat** to listen to the system prompts again

Notice the visual cues that inform you of your voice recognition system's status. Cues appear on the touchscreen.



Uconnect 8.4 NAV

Radio

Use your voice to quickly get to the AM, FM or SiriusXM Satellite Radio stations you would like to hear. (Subscription or included SiriusXM Satellite Radio trial required.)

Push the VR button . After the beep, say:

- **Tune to** ninety-five-point-five FM
- **Tune to** Satellite Channel Hits 1

TIP: At any time, if you are not sure of what to say or want to learn a Voice Command, push the VR button  and say **"Help."** The system will provide you with a list of commands.



Uconnect 8.4 NAV Radio

Media

Uconnect offers connections via USB, SD, Bluetooth and auxiliary ports (If Equipped). Voice operation is only available for connected USB devices.

Push the VR button . After the beep, say one of the following commands and follow the prompts to switch your media source or choose an artist.

- **Change source** to Bluetooth
- **Change source** to iPod
- **Change source** to USB
- **Play artist** Beethoven; **Play album** Greatest Hits; **Play song** Moonlight Sonata; **Play genre** Classical

TIP: Press the Browse button on the touchscreen to see all of the music on your USB device. Your Voice Command must match **exactly** how the artist, album, song and genre information is displayed.



Uconnect 8.4 NAV Media

Phone

Making and answering hands-free phone calls is easy with Uconnect. When the Phone-book button is illuminated on your touchscreen, your system is ready.

U.S. residents can visit:

- UconnectPhone.com for device compatibility and pairing instructions.

Canadian residents can visit:

- UconnectPhone.com for mobile phone compatibility and pairing instructions.

Push the Phone button . After the beep, say one of the following commands...

- **Call** John Smith
- **Dial** 123-456-7890 and follow the system prompts
- **Redial** (call previous outgoing phone number)
- **Call back** (call previous incoming phone number)

TIP: When providing a Voice Command, push the Phone button  and say **“Call,”** then pronounce the name **exactly** as it appears in your phone book. When a contact has multiple phone numbers, you can say **“Call John Smith work.”**



Uconnect 8.4 NAV Phone

Siri Eyes Free — If Equipped

Siri lets you use your voice to send text messages, select media, place phone calls and much more. Siri uses your natural language to understand what you mean and will respond back to confirm your requests. The system is designed to keep your eyes on the road and your hands on the wheel by letting Siri help you perform useful tasks.

To enable Siri push and hold, then release the Uconnect Voice Recognition (VR) button on the steering wheel. After you hear a double beep you can ask Siri to play podcasts and music, get directions, read text messages and many other useful requests.



Siri Eyes Free Available

Getting Started

Ensure Siri is enabled on your iPhone.



Enable Siri

1 — Select Settings on your iPhone
 2 — Select General

3 — Select Siri
 4 — Enable Siri



1. Pair your Siri enabled device to the vehicles sound system. Refer to “Uconnect Phone” in “Electronics” for a detailed pairing procedure.



Pair Your iPhone

2. Push and Hold the Uconnect Voice Recognition (VR) button  on the steering wheel. After you hear the familiar Siri "double beep," say a command.

NOTE:

A **push and release** of the  button will start normal embedded VR functions. The **push and hold** of the  button will start Siri functions.

3. After the audible tone, begin speaking to Siri.

Examples of Siri commands and questions:

- "Will it be sunny tomorrow?"
- "What time is it in Michigan?"
- "Remind me to pick up the dry-cleaning tomorrow at 5 pm."
- "Did the Red Wings win their last game?"



NOTE:

- Speak clearly at a normal pace and volume while facing straight ahead to ensure your command is understood.
- Siri is available on iPhone 4S and later.



Siri Eyes Free

Voice Text Reply

Uconnect will announce **incoming** text messages. Push the Phone button  and say **Listen**. (Must have compatible device paired to Uconnect system.)

1. Once an incoming text message is read to you, push the Phone button . After the beep, say: **Reply**.
2. Listen to the Uconnect prompts. After the beep, repeat one of the pre-defined messages and follow the system prompts.

PRE-DEFINED VOICE TEXT REPLY RESPONSES		
Yes.	Stuck in Traffic.	See you later.
No.	Start without me.	I'll be Late.
Okay.	Where are you?	I will be <number> minutes late.
Call me.	Are you there yet?	
I'll call you later.	I need directions.	See you in <number> minutes.
I'm on my way.	Can't talk right now.	Thanks.
I'm lost.		

TIP: Your device must have the full implementation of the **Message Access Profile (MAP)** to take advantage of this feature. For details about MAP, visit UconnectPhone.com for U.S. residents. Apple iPhone iOS6 or later supports reading **incoming** text messages only.

To enable this feature on your Apple iPhone, follow these 4 simple steps:

1. Select "Settings"
2. Select "Bluetooth"
3. Select the (i) for the paired vehicle
4. Turn on "Show Notifications"

TIP: Voice Text Reply is not compatible with iPhone, but if your vehicle is equipped with Siri Eyes Free, you can use your voice to send a text message.



iPhone Notification Setting

Climate

Too hot? Too cold? Adjust vehicle temperatures hands-free and keep everyone comfortable while you keep moving ahead.

Push the VR button . After the beep, say one of the following commands:

- **Set temperature to 70 degrees**

TIP: Voice Command for Climate may only be used to adjust the interior temperature of your vehicle.



Uconnect 8.4 NAV Climate

Navigation

The Uconnect navigation feature helps you save time and become more productive when you know exactly how to get to where you want to go.

1. To enter a destination, push the VR button . After the beep, say:
 - For the 8.4 NAV Uconnect, say: **Find Address** 800 Chrysler Drive Auburn Hills, Michigan.
2. Then follow the system prompts.

TIP: To start a POI search, push the VR button . After the beep, say “**Find nearest** coffee shop.”



Uconnect 8.4 NAV Navigation

Uconnect Access — If Equipped (8.4 NAV)

WARNING!

ALWAYS obey traffic laws and pay attention to the road. Some Uconnect Access services, including 9-1-1 and Assist, will NOT work without an operable 1X(voice/data) or 3G(data) network connection.

NOTE:

Your vehicle may be transmitting data as authorized by the subscriber.

An included trial and/or subscription is required to take advantage of the Uconnect Access services in the next section of this guide. To register with Uconnect Access, press the “Apps” button on the 8.4-inch touchscreen to get started. Detailed registration instructions can be found on the next page.

NOTE:



- If your vehicle is not connected to an operable 1X (voice/data) or 3G (data) network, the signal strength bars on the “Apps” button on the touchscreen will show a single bar and a prohibition symbol to indicate your vehicle is not connected to an operable 1X (voice/data) or 3G (data) network.

- Uconnect Access is available only on equipped vehicles purchased within the continental United States, Alaska and Hawaii. Vehicle is not connected to an operable 1X (voice/data) or 3G (data) network. Services can only be used where coverage is available; see coverage map for details.

 9-1-1 Call

 Remote Door Lock/Unlock

 Remote Horn and Lights

 Roadside Assistance Call

 Theft Alarm Notification

 Stolen Vehicle Assistance

 Yelp Search

 Voice Texting

 3G Wi-Fi Hotspot***

***Extra charges apply.

Register (8.4 NAV)

To unlock the full potential of Uconnect Access in your vehicle, you first need to register with Uconnect Access.

1. Push the ASSIST button on your rearview mirror.



ASSIST Button

2. Press the “Uconnect Care” button on the touchscreen.
3. A helpful Uconnect Care Agent will register your vehicle and handle all of the details.

Signing up is easy! Simply follow the steps above. Or, press the “Apps  ” button on the touchscreen, then select the Uconnect registration app to “Register By Web” to complete the process using your device or computer.

For further information please visit www.driveuconnect.com

Mobile App (8.4 NAV)

You're only a few steps away from using remote commands and playing your favorite music in your car.

To link your internet radio accounts:

1. Download the **Uconnect Access App** on your device.
2. Press the Via Mobile icon on the navigation bar at the bottom of the app.
3. Press the app you'd like to connect to your vehicle.
4. Enter your login information for the selected app and press Link.
5. Next time you're in your vehicle, enable Bluetooth, pair your device and select the Via Mobile app you want to play from the Uconnect touchscreen to stream your personalized music.



Mobile App

NOTE:

- You can also complete this process on the web. Simply visit moparownerconnect.com log in and click **Set Up Via Mobile Profile** (under Quick Links).
- Once you download the app to your compatible device, you will also be able to lock/unlock its doors from virtually anywhere.

Voice Texting (8.4 NAV)

You must be registered with Uconnect Access and have a compatible MAP – enabled device to use your voice to send a personalized text message. (Not compatible with iPhone.)

1. To send a message, push the Phone button . After the beep, say: **“Send message to John Smith.”**
2. Listen to the prompt. After the beep, dictate the message you would like to send. Wait for Uconnect to process your message.
3. The Uconnect system will repeat your message and provide a variety of options to add to, delete, send or hear the message again. After the beep, tell Uconnect what you'd like to do. For instance, if you're happy with your message, after the beep, say **“Send.”**

You must be registered with Uconnect Access and have a compatible MAP – enabled device to use your voice to send a personalized text message. For details about MAP, visit UconnectPhone.com. Apple iPhone iOS6 or later supports reading incoming text messages only. To enable this feature on your Apple iPhone, follow these 4 simple steps:

1. Select “Settings”
2. Select “Bluetooth”
3. Select the (i) for the paired vehicle
4. Turn on “Show Notifications”

TIP:



- Voice Texting is not compatible with iPhone, but if your vehicle is equipped with Siri Eyes Free, you can use your voice to send a text message.
- Messages are limited to 140 characters.
- The Messaging button on the touch-screen must be illuminated to use the feature.



iPhone Notification Setting

Yelp (8.4 NAV)

Once registered with Uconnect Access, you can use your voice to search for the most popular places or things around you.

1. Push the VR button . After the beep, say: **Launch YELP**.
2. Once the YELP home screen appears on the touchscreen, push the VR button , then say: **YELP search**.
3. Listen to the system prompts and after the beep, tell Uconnect the place or business that you'd like Uconnect to find.

TIP: Once you perform a search, you can reorganize the results by selecting either the Best Match, Rating or Distance tab on the top of the touchscreen display.



Yelp

SiriusXM Travel Link (8.4 NAV — US Market Only)

Need to find a gas station, view local movie listings, check a sports score or the 5 - day weather forecast? SiriusXM Travel Link is a suite of services that brings a wealth of information right to your Uconnect 8.4 NAV system.

Push the VR button . After the beep, say one of the following commands:

- **Show fuel prices**
- **Show 5 - day weather forecast**
- **Show extended weather**

TIP: Traffic alerts are not accessible with Voice Command.



SiriusXM Travel Link

Additional Information

© 2016 FCA US LLC. All rights reserved. Mopar, Mopar Owner Connect and Uconnect are registered trademarks of FCA US LLC. Android is a trademark of Google Inc. SiriusXM and all related marks and logos are trademarks of SiriusXM Radio Inc. Yelp, Yelp logo, Yelp burst and related marks are registered trademarks of Yelp.

Uconnect System Support:

- U.S. residents visit DriveUconnect.com or call: 1-877-855-8400 (24 hours a day 7 days a week)
- Canadian residents visit DriveUconnect.ca or call: 1-800-465-2001 (English) or 1-800-387-9983 (French)

Mon. – Fri., 8:00 am – 8:00 pm, ET

Sat., 9:00 am – 5:00 pm, ET

Sun., Closed

Uconnect Access Services Support. 1-855-792-4241 Please have your Uconnect Security PIN ready when you call.

UCONNECT PHONE

Uconnect Phone (Bluetooth Hands Free Calling)



Uconnect 8.4 NAV Phone Menu

- | | |
|--------------------------------------|---|
| 1 — Favorite Contacts | 12 — Browse Phone Book Entries (Contains 9-1-1) |
| 2 — Mobile Phone Battery Life | 13 — End Call |
| 3 — Currently Paired Mobile Phone | 14 — Call/Redial/Hold |
| 4 — Mobile Phone Signal Strength | 15 — Do Not Disturb |
| 5 — Mute Microphone | 16 — Reply with Text Message |
| 6 — Transfer To/From Uconnect System | * — Conference call feature only available on GSM mobile devices |
| 7 — Conference Call* | ** — Text messaging feature not available on all mobile phones (requires Bluetooth MAP profile) |
| 8 — Manage Paired Mobile Phones | |
| 9 — Text Messaging** | |
| 10 — Direct Dial Pad | |
| 11 — Recent Call Log | |

The Uconnect Phone feature enables you to place and receive hands-free mobile phone calls. Drivers can also place mobile phone calls using their voice or by using the buttons on the touchscreen (see Voice Command section).

The hands-free calling feature is made possible through Bluetooth technology — the global standard that enables different electronic devices to connect to each other wirelessly.

If the Uconnect Phone Button  exists on your steering wheel, you then have the Uconnect Phone features.

NOTE:

- The Uconnect Phone requires a mobile phone equipped with the Bluetooth Hands-Free Profile, Version 1.0 or higher.
- Most mobile phones/devices are compatible with the Uconnect system, however some mobile phones/devices may not be equipped with all of the required features to utilize all of the Uconnect system features.
- For Uconnect Customer Care:
 - U.S. residents visit UconnectPhone.com or call 1-877-855-8400 .
 - Canadian Residents visit UconnectPhone.com or call, 1-800-465-2001 (English) or 1-800-387-9983 (French).

Pairing (Wirelessly Connecting) Your Mobile Phone To The Uconnect System

Mobile phone pairing is the process of establishing a wireless connection between a cellular phone and the Uconnect system.

NOTE:

- To use the Uconnect Phone feature, you first must determine if your mobile phone and software are compatible with the Uconnect system. Please visit UconnectPhone.com for complete mobile phone compatibility information.
- Mobile phone pairing is not available while the vehicle is in motion.
- A maximum of 10 mobile phones can be paired to the Uconnect system.

Start Pairing Procedure On The Radio

Uconnect 8.4 NAV:

1. Place the ignition in the ACC or ON position.
2. Press the “Phone” button in the Menu Bar on the touchscreen.
3. Select “Settings”.
4. Select “Paired Phones”.
5. Select “Add device”.

- Uconnect Phone will display an “In progress” screen while the system is connecting.



Uconnect 8.4 NAV

Pair Your iPhone:

To search for available devices on your Bluetooth enabled iPhone:

1. Press the Settings button.
2. Select Bluetooth.
 - Ensure the Bluetooth feature is enabled. Once enabled, the mobile phone will begin to search for Bluetooth connections.
3. When your mobile phone finds the Uconnect system, select "Uconnect."



Bluetooth On/Uconnect Device

Complete The iPhone Pairing Procedure:

1. When prompted on the mobile phone, accept the connection request from Uconnect Phone.

NOTE:

Some mobile phones will require you to enter the PIN number.



Pairing Request

Select The iPhone's Priority Level

When the pairing process has successfully completed, the system will prompt you to choose whether or not this is your favorite mobile phone. Selecting "Yes" will make this mobile phone the highest priority. This mobile phone will take precedence over other paired mobile phones within range and will connect to the Uconnect system automatically when entering the vehicle. Only one mobile phone and/or one Bluetooth audio device can be connected to the Uconnect system at a time. If "No" is selected, simply select "Uconnect" from the mobile phone/audio device Bluetooth screen, and the Uconnect system will reconnect to the Bluetooth device.

Pair Your Android Device:

To search for available devices on your Bluetooth enabled Android Device:

1. Push the Menu button.
2. Select Settings.
3. Select Connections.
4. Turn Bluetooth setting to “On”.
 - Ensure the Bluetooth feature is enabled. Once enabled, the mobile phone will begin to search for Bluetooth connections.
5. Once your mobile phone finds the Uconnect system, select “Uconnect”.
 - You may be prompted by your mobile phone to download the phonebook, check “Do Not Ask Again” to automatically download the phonebook. This is so you can make calls by saying the name of your contact.

Complete The Android Pairing Procedure:

1. Confirm the passkey shown on the mobile phone matches the passkey shown on the Uconnect system then accept the Bluetooth pairing request.

NOTE:

Some mobile phones require the PIN to be entered manually, enter the PIN number shown on the Uconnect screen.



Uconnect Device

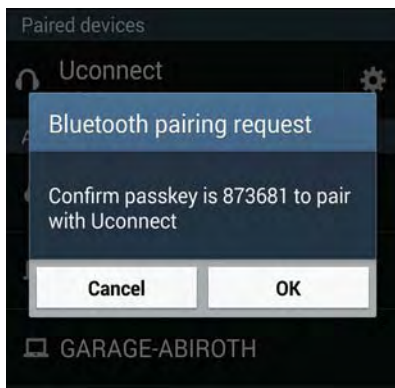

Pairing Request

Select The Android Mobile Phone's Priority Level

When the pairing process has successfully completed, the system will prompt you to choose whether or not this is your favorite mobile phone. Selecting “Yes” will make this mobile phone the highest priority. This mobile phone will take precedence over other paired mobile phones within range and will connect to the Uconnect system automatically when entering the vehicle. Only one mobile phone and/or one Bluetooth audio device can be connected to the Uconnect system at a time. If “No” is selected, simply select “Uconnect” from the mobile phone/audio device Bluetooth screen, and the Uconnect system will reconnect to the Bluetooth device.

You are now ready to make hands-free calls. Press the Uconnect “Phone” button  on your steering wheel to begin.

NOTE:

Refer to UconnectPhone.com website for additional information on mobile phone pairing and for a list of compatible phones.

Common Phone Commands (Examples)

- “Call John Smith”
- “Call John Smith mobile”
- “Dial 1 248 555 1212”
- “Redial”

Mute (Or Unmute) Microphone During Call

- During a call, press the “Mute” button on the Phone main screen to mute and unmute the call.

Transfer Ongoing Call Between Handset And Vehicle

- During an on-going call, press the “Transfer” button on the Phone main screen to transfer an on-going call between handset and vehicle.

Phonebook

The Uconnect system will automatically sync your phonebook from your paired phone, if this feature is supported by your phone. Phonebook contacts are updated each time that the phone is connected. If your phone book entries do not appear, check the settings on your phone. Some phones require you to enable this feature manually.

- Your phonebook can be browsed on the Uconnect system touchscreen, but editing can only be done on your phone. To browse, press the “Phone” button on the touchscreen, then the “Phonebook” button on the touchscreen.

Favorite phonebook entries can be saved as Favorites for quicker access. Favorites are shown at the top of the main phone screen.



Voice Command Tips

- Speaking complete names (i.e; Call John Doe vs. Call John) will result in greater system accuracy.
- You can “link” commands together for faster results. Say “Call John Doe, mobile,” for example.
- If you are listening to available voice command options, you do not have to listen to the entire list. When you hear the command that you need, push the  button on the steering wheel, wait for the beep and say your command.

Changing The Volume

- Start a dialogue by pushing the Phone button , then say a command for example - "Help".
- Use the radio VOLUME/MUTE rotary knob to adjust the volume to a comfortable level while the Uconnect system is speaking. Please note the volume setting for Uconnect is different than the audio system.

NOTE:

To access help, push the Uconnect Phone button  on the steering wheel and say "help." Press the display or press either the Phone  or VR  button and say "cancel" to cancel the help session.

Using Do Not Disturb

With Do Not Disturb, you can disable notifications from incoming calls and texts, allowing you to keep your eyes on the road and hands on the wheel. For your convenience there is a counter display to keep track of your missed calls and text messages while you were using Do Not Disturb.

Do Not Disturb can automatically reply with a text message, a call or both, when declining an incoming call and send it to voicemail.

Automatic reply messages can be:

- “I am driving right now, I will get back to you shortly.”
- Create a custom auto reply message up to 160 characters.

While in Do Not Disturb, Conference Call can be selected so you can still place a second call without being interrupted by incoming calls.

NOTE:

- Only the beginning of your custom message will be seen on the touchscreen.
- Reply with text message is not compatible with iPhones.
- Auto reply with text message is only available on phones that supporting Bluetooth MAP.

Incoming Text Messages

After pairing your Uconnect system with a Bluetooth enabled mobile device with the Message Access Profile (MAP), the Uconnect system can announce a new incoming text message and read it to you over the vehicle's audio system.

NOTE:

Only incoming text messages received during the current ignition cycle can be viewed/read.

To enable incoming text messaging:

iPhone

1. Press the settings button on the mobile phone.
2. Select Bluetooth.
 - Ensure Bluetooth is enabled, and the mobile phone is paired to the Uconnect system.
3. Select ⓘ located under DEVICES next to Uconnect.
4. Turn "Show Notifications" to on.



Enable iPhone Incoming Text Messages

Android Devices

1. Push the Menu button on the mobile phone.
2. Select Settings.
3. Select Connections.
4. Turn "Show Notifications" to on.
 - A pop up will appear asking you to accept a request for permission to connect to your messages. Select "Don't ask again" and press OK.

NOTE:

All incoming text messages received during the current ignition cycle will be deleted from the Uconnect system when the ignition is turned to the OFF position.

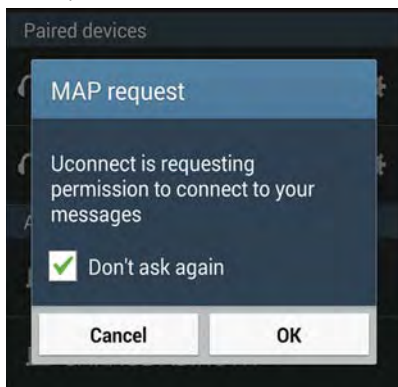

Enable Android Device Incoming Text Messages

Voice Text Reply (Not Compatible With iPhone)

NOTE:

Voice texting reply and voice texting features require a compatible mobile device enabled with Bluetooth Message Access Profile (MAP). iPhone, and some other smartphones, may not entirely support Bluetooth MAP. Visit UconnectPhone.com for the latest system and device compatibility.

- Due to the extremely large number of mobile phone manufacturers, your mobile device may not be listed. For further assistance, contact Uconnect Customer Care 1-877-855-8400 for U.S. residents or, 1-800-465-2001 (English) / 1-800-387-9983 (French) for Canadian residents.

Once your Uconnect system is paired with a compatible mobile device, the system can announce a new incoming text message, and read it to you over the vehicle audio system. You can reply to the message using Voice Recognition by selecting, or saying, one of the 18 pre-defined messages.

Here's How:

- Push the Uconnect Phone button  and wait for the beep, then say “reply.” Uconnect will give the following prompt: “Please say the message you would like to send.” Wait for the beep and say one of the pre-defined messages. (If you are not sure, you can say “help” at any time). Uconnect will then read the pre-defined messages allowed. As soon as you hear the message you would like to send, you can interrupt the list of prompts by pushing the Uconnect Phone button and saying the phrase. Uconnect will confirm the message by reading it back to you. Push the Phone button and say “Send.”

PRE-DEFINED VOICE TEXT REPLY RESPONSES

Yes.	Stuck in Traffic.	See you later.
No.	Start without me.	I'll be Late.
Okay.	Where are you?	I will be <5, 10, 15,...etc.> minutes late.
Call me.	Are you there yet?	
I'll call you later.	I need directions.	See you in <5, 10, 15,...etc.> of minutes.
I'm on my way.	Can't talk right now.	
I'm lost.		Thanks.

Want to dictate a personal message?

- You must first register with Uconnect Access (U.S. residents only) to take advantage of a new, cloud-based Voice Texting service, an enhancement to Voice Text Reply (Uconnect 8.4 NAV system ONLY).

Helpful Tips And Common Questions To Improve Bluetooth Performance With Your Uconnect System

Mobile Phone won't reconnect to system after pairing:

- Set mobile phone to auto-connect or trusted device in mobile phone Bluetooth settings (Blackberry devices).
- Perform a factory reset on your mobile phone. Refer to your mobile phone manufacturer or cellular provider for instructions.
- Many mobile phones do not automatically reconnect after being restarted (hard reboot). Your mobile phone can still be connected manually. Close all applications that may be operating (refer to mobile phone manufacturer's instructions), and follow “Pairing (Wirelessly Connecting) Your Mobile Phone To The Uconnect System”.

Mobile Phone won't pair to system:

- Perform a hard reset in the mobile phone by removing the battery (if removable — see your mobile phone's owner manual).
- Delete pairing history in mobile phone and Uconnect system; usually found in phone's Bluetooth connection settings.
- Verify you are selecting “Uconnect” in the discovered Bluetooth devices on your mobile phone.
- If your vehicle system generates a pin code the default is 0000.

Mobile Phonebook didn't download:

- Check "Do not ask again," then accept the "phonebook download" request on your mobile phone.
- Up to 5,000 contact names with four numbers per contact will transfer to the Uconnect 8.4 NAV system phonebook.

Text messaging won't work:

- Check "Do not ask again," then accept the "connect to your messages" request on your mobile phone.
- Verify that your mobile phone has the Bluetooth feature (Message Access Profile).

Can't make a conference call:

- CDMA (Code-Division Multiple Access) carriers do not support conference calling. Refer to your mobile phone user's manual for further information.

Making calls while connected to AUX:

- Plugging in your mobile phone to AUX while connected to Bluetooth will disable Hands-Free Calling. Do not make calls while your mobile phone is plugged into the AUX jack.

STEERING WHEEL AUDIO CONTROLS

The steering wheel audio controls are located on the rear surface of the steering wheel.

Right Switch

- Push the switch up or down to increase or decrease the volume.
- Push the button in the center to change modes AM/FM/SAT.

Left Switch

- Push the switch up or down to search for the next listenable station or select the next or previous track.
- Push the button in the center to select the next preset radio station.

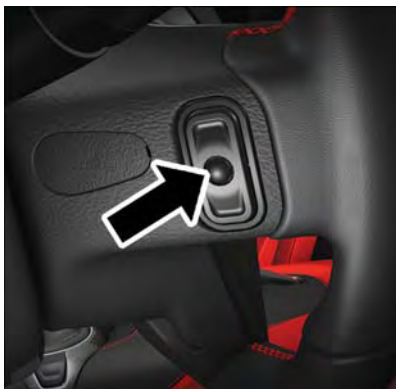

Steering Wheel Audio Controls

INSTRUMENT CLUSTER DISPLAY

Instrument Cluster Display Controls

The instrument cluster display features a driver interactive display that is located in the instrument cluster. Pushing the controls on the left side of the steering wheel allows the driver to select vehicle information and Personal Settings. Refer to “Programmable Features” in this guide for additional information.

- Push the **up** \triangle arrow button to scroll upward through the main menus (Tach, MPH/kmh, Vehicle Info, Fuel Economy, Trip A, Trip B, Audio, Stored Messages, Screen Setup, Performance, Diagnostics, Hibernation) and sub menus.
- Push the **down** ∇ arrow button to scroll downward through the main menus and sub menus.
- Push the **right** \triangleright arrow button for access to main menus, sub menus or to select a personal setting in the setup menu.
- Push the **left** \triangleleft arrow button to scroll back to a previous menu or sub menu.



Instrument Cluster Display Controls

NOTE:



Pushing the **left** \triangleleft arrow button will override the instrument cluster display five second “pop up” messages and return you to the menu screen.

Compass Calibration

This compass is self-calibrating, which eliminates the need to set the compass manually. When the vehicle is new, the compass may appear erratic, and the cluster will display dashes (- -) until the compass is calibrated.

You may also calibrate the compass by completing one or more 360 degree turns (in an area free from large metal or metallic objects) until the dashes (- -) displayed in the cluster turn off. The compass will now function normally.

Instrument Cluster Display Selectable Menu Items

The instrument cluster display can be used to select and configure which vehicle information is displayed. To step to each main menu feature push the **up**  or **down**  arrow button once for each step. A step from the last item in the list will cause the first item in the feature list to be displayed. The following features are in the Main menu:

- Tach
- MPH/kmh
- Vehicle Info
- Fuel Economy
- Trip A
- Trip B
- Audio
- Stored Messages
- Screen Set Up
- Performance
- Hibernate

NOTE:

For features in the instrument cluster display that can be reset (Average Fuel Economy), the instrument cluster display prompts a reset with a **right**  arrow button graphic and the word RESET next to it.

Key Fob Programmable Features

The following features may also be programmed by using the key fob or the ignition and driver's door lock switch. Refer to "Uconnect Settings" in "Understanding Your Instrument Panel" in the Owner's Manual on the DVD for further information.

NOTE:

Pushing the lock button while you are inside the vehicle will activate the Vehicle Security Alarm. Opening a door with the Vehicle Security Alarm activated will cause the alarm to sound. Push the unlock button to deactivate the Vehicle Security Alarm.

Unlock On First Press

To unlock either the driver's side, or all doors, on the first press of the unlock button:

1. Push and hold the lock button for at least four seconds, but no longer than 10 seconds. Then, push and hold the unlock button while still holding the lock button.
2. Release both buttons at the same time.

Auto Unlock Doors On Exit

To have all of the vehicle doors unlock when any door is opened:

1. Enter your vehicle and close all the doors, and fasten your seat belt.
2. Cycle the ignition switch between the OFF and ON position four times, ending in the OFF position (do not start the engine).
3. Push the power door unlock switch to unlock the doors. A single chime will indicate that programming is complete.

Sound Horn With Lock

To turn the horn chirp on or off when the doors are locked:

1. Push the lock button for at least four seconds, but no longer than 10 seconds. Then, push the PANIC button while still holding the lock button.
2. Release both buttons at the same time.

Flashing Lights With Lock

The turn signal lights flash when the doors are locked, which can be turned on or off. To turn this feature on or off:

1. Push and hold the unlock button and the lock button at the same time for at least four seconds, but no longer than 10 seconds.
2. Release both buttons at the same time.

PERFORMANCE PAGES

Performance Features

The instrument cluster display can be used to program the following Performance Features. Push the **up** \triangle or **down** ∇ arrow button until Performance Features displays, then push the **right** \triangleright arrow button. Scroll through the settings using the **up** \triangle or **down** ∇ arrow button. Push the **right** \triangleright arrow button to change the setting. Push the **left** \triangleleft arrow button to scroll back to a previous menu or sub menu.

- 0-60 Time
- Braking Distance
- 1/4 Mile
- 1/8 Mile
- G-Force Instant
- G-Force Peak



Instrument Cluster Display Controls

Uconnect SRT Performance Pages

- To access the SRT Performance Pages, press the “Apps” button on the touchscreen then select “Performance Pages.” Press the UP or DOWN button on the touchscreen to cycle through the features.

The Performance Pages include the following:

- Home
- Timers
- G-Force
- Gauges 1
- Gauges 2
- Engine
- Options

PROGRAMMABLE FEATURES

Uconnect Customer Programmable Features

The Uconnect system allows you to access Customer Programmable feature settings such as Display, Voice, Clock, Safety & Driving Assistance, Lights, Doors & Locks, Engine Off Options, Audio, Phone / Bluetooth, SiriusXM Setup, Restore Settings, Clear Personal Data, and System Information through buttons on the touchscreen.

- Press the “Apps” button on the touchscreen, then press the “Settings” button on the touchscreen to access the Settings screen. When making a selection, scroll up or down until the preferred setting is highlighted, then press and release the preferred setting until a check-mark appears next to the setting, showing that setting has been selected. The following feature settings are available:

- Display
- Voice
- Clock
- Safety & Driving Assistance
- Lights
- Doors & Locks
- Engine Off Options
- Audio
- Phone / Bluetooth
- SiriusXM Setup
- Restore Settings
- Clear Personal Data
- System Information

UNIVERSAL GARAGE DOOR OPENER (HomeLink)

HomeLink replaces up to three hand-held transmitters that operate devices such as garage door openers, motorized gates, lighting or home security systems. The HomeLink unit is powered by your vehicle's 12 Volt battery.

- The HomeLink buttons that are located in the overhead console or sunvisor designate the three different HomeLink channels.
- The HomeLink indicator is located above the center button.



HomeLink Universal Garage Door Opener

Before You Begin Programming HomeLink

Ensure that your vehicle is parked outside of the garage before you begin programming.

For efficient programming and accurate transmission of the radio-frequency signal, it is recommended that a new battery be placed in the hand-held transmitter of the device that is being programmed to the HomeLink system.

To erase the channels, place the ignition switch into the ON/RUN position, then push and hold the two outside HomeLink buttons (I and III) for up to 20 seconds or until the red indicator flashes.

NOTE:

Erasing all channels should only be performed when programming HomeLink for the first time. Do not erase channels when programming additional buttons.

If you have any problems, or require assistance, please call toll-free 1-800-355-3515 or, on the Internet at HomeLink.com for information or assistance.

Programming A Rolling Code

NOTE:

For programming Garage Door Openers that were manufactured after 1995. These Garage Door Openers can be identified by the "LEARN" or "TRAIN" button located where the hanging antenna is attached to the Garage Door Opener. It is NOT the button that is normally used to open and close the door. The name and color of the button may vary by manufacturer.

1. Place the ignition switch into the ON/RUN position.

2. Place the hand-held transmitter 1 to 3 inches (3 to 8 cm) away from the HomeLink button you wish to program while keeping the HomeLink indicator light in view.
3. Push and hold the HomeLink button you want to program while you push and hold the hand-held transmitter button.
4. Continue to hold both buttons and observe the indicator light. The HomeLink indicator will flash slowly and then rapidly after HomeLink has received the frequency signal from the hand-held transmitter. Release both buttons after the indicator light changes from slow to rapid.
5. At the garage door opener motor (in the garage), locate the “LEARN” or “TRAINING” button. This can usually be found where the hanging antenna wire is attached to the garage door opener motor. Firmly push and release the “LEARN” or “TRAINING” button.

NOTE:

You have 30 seconds in which to initiate the next step after the LEARN button has been pushed.

6. Return to the vehicle and push the programmed HomeLink button twice (holding the button for two seconds each time). If the device is plugged in and activates, programming is complete.

NOTE:

If the device does not activate, push the button a third time (for two seconds) to complete the training.

7. To program the remaining two HomeLink buttons, repeat each step for each remaining button. DO NOT erase the channels.

Programming A Non-Rolling Code

NOTE:

For programming Garage Door Openers manufactured before 1995.

1. Place the ignition switch to the ON/RUN position.
2. Place the hand-held transmitter 1 to 3 inches (3 to 8 cm) away from the HomeLink button you wish to program while keeping the HomeLink indicator light in view.
3. Push and hold the HomeLink button you want to program while you push and hold the hand-held transmitter button.

4. Continue to hold both buttons and observe the indicator light. The HomeLink indicator will flash slowly and then rapidly after HomeLink has received the frequency signal from the hand-held transmitter. Release both buttons after the indicator light changes from slow to rapid.
5. Push and hold the programmed HomeLink button and observe the indicator light. If the indicator light stays on constantly, programming is complete and the garage door (or device) should activate when the HomeLink button is pushed.
6. To program the two remaining HomeLink buttons, repeat each step for each remaining button. DO NOT erase the channels.

Using HomeLink

To operate, push and release the programmed HomeLink button. Activation will now occur for the programmed device (i.e., garage door opener, gate operator, security system, entry door lock, home/office lighting, etc.,). The hand-held transmitter of the device may also be used at any time.

WARNING!
<ul style="list-style-type: none">• Your motorized door or gate will open and close while you are programming the universal transceiver. Do not program the transceiver if people or pets are in the path of the door or gate.• Do not run your vehicle in a closed garage or confined area while programming the transceiver. Exhaust gas from your vehicle contains Carbon Monoxide (CO) which is odorless and colorless. Carbon Monoxide is poisonous when inhaled and can cause you and others to be severely injured or killed.

POWER OUTLETS

The auxiliary 12 Volt (13 Amp) power outlets can provide power for in-vehicle accessories designed for use with the standard “cigar lighter” plug. The 12 Volt power outlets have a cap attached to the outlet indicating “12V DC”, together with either a key symbol or a battery symbol.

The auxiliary power outlets can be found in the following locations:

- To the right of the shifter on the console.
- Rear area of the center console.

NOTE:

- Do not exceed the maximum power of 160 Watt (13 Amp) at 12 Volts. If the 160 Watt (13 Amp) power rating is exceeded, the fuse protecting the system will need to be replaced.
- Power outlets are designed for accessory plugs only. Do not insert any other object in the power outlet as this will damage the outlet and blow the fuse. Improper use of the power outlet can cause damage not covered by your new vehicle limited warranty.



Front 12V Power Outlet



Rear 12V Power Outlet

TRAILER TOWING WEIGHTS (MAXIMUM TRAILER WEIGHT RATINGS)

Trailer towing with this vehicle is not recommended.

RECREATIONAL TOWING (BEHIND MOTORHOME, ETC.)

Towing This Vehicle Behind Another Vehicle (Flat Towing With All Four Wheels On The Ground)

Towing Condition	Wheels OFF The Ground	Manual Transmission
Flat Tow	None	NOT ALLOWED
Dolly Tow	Front	NOT ALLOWED
	Rear	NOT RECOMMENDED
On Trailer	All	OK

NOTE:

If the vehicle requires towing, make sure all four wheels are off the ground.

CAUTION!

Towing this vehicle in violation of the above requirements can cause severe transmission damage. Damage from improper towing is not covered under the New Vehicle Limited Warranty.

WHAT TO DO IN EMERGENCIES

ROADSIDE ASSISTANCE

Dial toll-free 1-800-521-2779 for U.S. Residents or 1-800-363-4869 for Canadian Residents.

- Provide your name, vehicle identification number, license plate number, and your location, including the telephone number from which you are calling.
- Briefly describe the nature of the problem and answer a few simple questions.
- You will be given the name of the service provider and an estimated time of arrival. If you feel you are in an “unsafe situation”, please let us know. With your consent, we will contact local police or safety authorities.

WARNING AND INDICATOR LIGHTS

IMPORTANT: The warning/indicator lights switch on in the instrument panel together with a dedicated message and/or acoustic signal when applicable. These indications are indicative and precautionary and as such must not be considered as exhaustive and/or alternative to the information contained in the Owner’s Manual, which you are advised to read carefully in all cases. Always refer to the information in this chapter in the event of a failure indication.

All active telltales will display first, if applicable. The system check menu may appear different based upon equipment options and current vehicle status.

This guide illustrates and describes the operation of warning and indicator telltales that are either standard or optional based on the vehicle build. FCA reserves the right to make changes in design and specifications and/or make additions to or improvements to its products without imposing any obligation upon itself to install them on products previously manufactured.

Instrument Cluster Warning Lights

– Low Fuel Warning Light

This warning light indicates when the fuel level reaches approximately 1.5 gal (5.8 L). This light will turn on and a single chime will sound.

– Battery Charge Warning Light

This light illuminates when the battery is not charging properly. If the battery charge warning light remains on, it means that the vehicle is experiencing a problem with the charging system.

We recommend you do not continue driving if the battery charge warning light is on. Have the vehicle serviced immediately.

WHAT TO DO IN EMERGENCIES

– Oil Pressure Warning Light

This light indicates low engine oil pressure. If the light turns on while driving, stop the vehicle and shut off the engine as soon as possible. A chime will sound when this light turns on.

We recommend you do not operate the vehicle or engine damage will occur. Have the vehicle serviced immediately.

– Anti-Lock Brake (ABS) Light

This light monitors the Anti-Lock Brake System (ABS).

If the light is not on during startup, stays on, or turns on while driving we recommend you contact the nearest authorized dealer and have the vehicle serviced immediately.

– Air Bag Warning Light

If the light is not on during startup, stays on, or turns on while driving have the vehicle serviced by an authorized dealer immediately.

– Electronic Throttle Control (ETC) Indicator Light

This light informs you of a problem with the Electronic Throttle Control (ETC) system.

If a problem is detected, the light will come on while the engine is running. Cycle the ignition when the vehicle has completely stopped and the gear selector is placed in the NEUTRAL position; the light should turn off.

If the light remains lit with the engine running, your vehicle will usually be drivable; however, see an authorized service center immediately. If the light is flashing when the engine is running, immediate service is required and you may experience reduced performance, an elevated/rough idle or engine stall and your vehicle may require towing.

– Tire Pressure Monitoring System (TPMS) Light

Each tire, including the spare (if provided), should be checked monthly when cold and inflated to the inflation pressure recommended by the vehicle manufacturer on the vehicle placard or tire inflation pressure label. (If your vehicle has tires of a different size than the size indicated on the vehicle placard or tire inflation pressure label, you should determine the proper tire inflation pressure for those tires).

As an added safety feature, your vehicle has been equipped with a tire pressure monitoring system (TPMS) that illuminates a low tire pressure telltale when one or more of your tires is significantly under-inflated. Accordingly, when the low tire pressure telltale illuminates, you should stop and check your tires as soon as possible and inflate them to the proper pressure. Driving on a significantly under-inflated tire causes the tire to overheat and can lead to tire failure. Under-inflation also reduces fuel efficiency and tire tread life and may affect the vehicle's handling and stopping ability.

WHAT TO DO IN EMERGENCIES

IF THE LIGHT SWITCHES ON AND A MESSAGE IS DISPLAYED INDICATING A LOW TIRE PRESSURE, ADJUST THE AIR PRESSURE IN THE LOW TIRE TO THE AIR PRESSURE SHOWN ON THE VEHICLE PLACARD OR TIRE INFLATION PRESSURE LABEL LOCATED ON THE DRIVER'S DOOR.

NOTE:

AFTER INFLATION, THE VEHICLE MAY NEED TO BE DRIVEN FOR 20 MINUTES ABOVE 15 MPH (24 KM/H) BEFORE THE FLASHING LIGHT WILL TURN OFF.

Please note that the TPMS is not a substitute for proper tire maintenance, and it is the driver's responsibility to maintain correct tire pressure, even if under-inflation has not reached the level to trigger illumination of the TPMS low tire pressure telltale.

Your vehicle has also been equipped with a TPMS malfunction indicator to indicate when the system is not operating properly. The TPMS malfunction indicator is combined with the low tire pressure telltale.

When the system detects a malfunction, the telltale will flash for approximately one minute and then remain continuously illuminated. This sequence will continue upon subsequent vehicle start-ups as long as the malfunction exists. When the malfunction indicator is illuminated, the system may not be able to detect or signal low tire pressure as intended. TPMS malfunctions may occur for a variety of reasons, including the installation of replacement or alternate tires or wheels on the vehicle that prevent the TPMS from functioning properly. Always check the TPMS malfunction telltale after replacing one or more tires or wheels on your vehicle to ensure that the replacement or alternate tires and wheels allow the TPMS to continue to function properly.

NOTE:

Tire pressures change by approximately 1 psi (7 kPa) per 12° F (7° C) of air temperature change. Keep this in mind when checking tire pressure inside a garage, especially in the Winter. Example: If garage temperature is 68°F (20°C), and the outside temperature is 32°F (0°C), then the cold tire inflation pressure should be increased by 3 psi (21 kPa), which equals 1 psi (7 kPa) for every 12°F (7°C) for this outside temperature condition.

CAUTION!

The TPMS has been optimized for the original equipment tires and wheels. TPMS pressures and warning have been established for the tire size equipped on your vehicle. Undesirable system operation or sensor damage may result when using replacement equipment that is not of the same size, type, and/or style. Aftermarket wheels can cause sensor damage. Do not use tire sealant from a can, or balance beads if your vehicle is equipped with a TPMS, as damage to the sensors may result.

WHAT TO DO IN EMERGENCIES

– Engine Temperature Warning Light

This light warns of an overheated engine condition.

If the light turns on or flashes continuously while driving, safely pull over and stop the vehicle. If the A/C system is on, turn it off. Also, shift the transmission into NEUTRAL and idle the vehicle. If the temperature reading does not return to normal, turn the engine off immediately.

We recommend that you do not operate the vehicle or engine damage will occur. Have the vehicle serviced immediately.

WARNING!

A hot engine cooling system is dangerous. You or others could be badly burned by steam or boiling coolant.

– Seat Belt Reminder Light

When the ignition switch is first turned to the ON/RUN position, this light will turn on for four to eight seconds as a bulb check. During the bulb check, if the driver's seat belt is unbuckled, a chime will sound. After the bulb check or when driving, if the driver or front passenger seat belt remains unbuckled, the Seat Belt Indicator Light will flash or remain on continuously. Refer to "Seat Belt Systems" in "Things To Know Before Starting" in your Owner's Manual on the DVD for further information.

BRAKE – Brake Warning Light

This light monitors various brake functions, including brake fluid level and parking brake application. If the brake light turns on, it may indicate that the parking brake is applied, that the brake fluid level is low, or that there is a problem with the brake system master cylinder reservoir.

If the light remains on when the parking brake has been disengaged, and the fluid level is at the full mark on the master cylinder reservoir, it indicates a possible brake hydraulic system malfunction or that a problem with the Brake Booster has been detected by the Anti-Lock Brake System (ABS)/Electronic Stability Control (ESC) system. In this case, the light will remain on until the condition has been corrected. If the problem is related to the brake booster, the ABS pump will run when applying the brake, and a brake pedal pulsation may be felt during each stop.

The dual brake system provides a reserve braking capacity in the event of a failure to a portion of the hydraulic system. A leak in either half of the dual brake system is indicated by the Brake Warning Light, which will turn on when the brake fluid level in the master cylinder has dropped below a specified level. The light will remain on until the cause is corrected.

WHAT TO DO IN EMERGENCIES

Vehicles equipped with the Anti-Lock Brake System (ABS) are also equipped with Electronic Brake Force Distribution (EBD). In the event of an EBD failure, the Brake Warning Light will turn on along with the ABS Light. Immediate repair to the ABS system is required.

Operation of the Brake Warning Light can be checked by turning the ignition switch from the OFF position to the ON/RUN position. The light should illuminate for approximately two seconds. The light should then turn off unless the parking brake is applied or a brake fault is detected. If the light does not illuminate, have the light inspected by an authorized dealer.

The light also will turn on when the parking brake is applied with the ignition switch in the ON/RUN position.

NOTE:

This light shows only that the parking brake is applied. It does not show the degree of brake application. In the case of the brake pads of the vehicle were worn out, brake warning light will be illuminated.

WARNING!

Driving a vehicle with the red brake light on is dangerous. Part of the brake system may have failed. It will take longer to stop the vehicle. You could have a collision. Have the vehicle checked immediately.

– **Malfunction Indicator Light (MIL)**

Certain conditions, such as a poor fuel quality, etc., may illuminate the MIL after engine start. The vehicle should be serviced if the light stays on through several typical driving cycles. In most situations, the vehicle will drive normally and not require towing.

If the MIL flashes when the engine is running, serious conditions may exist that could lead to immediate loss of power or severe catalytic converter damage. We recommend you do not operate the vehicle. Have the vehicle serviced immediately.

– **Electronic Stability Control (ESC) Indicator Light**

The “ESC Indicator Light” in the instrument cluster will come on when the ignition switch is turned to the ON/RUN position. It should go out with the engine running. If the “ESC Indicator Light” comes on continuously with the engine running, a malfunction has been detected in the ESC system.

If this light remains on after several ignition cycles, and the vehicle has been driven several miles (kilometers) at speeds greater than 30 MPH (48 km/h), we recommend you drive to the nearest service center and have the vehicle serviced immediately.

WHAT TO DO IN EMERGENCIES

Instrument Cluster Indicator Lights

– Turn Signal Indicator

The arrows will flash with the exterior turn signals when the turn signal lever is operated. A tone will chime, and an instrument cluster display message will appear if either turn signal is left on for more than 1 mile (1.6 km).

NOTE:

If either indicator flashes at a rapid rate, check for a defective outside light bulb.

– High Beam Indicator

Indicates that headlights are on high beam.

– Vehicle Security Light

This light will flash rapidly for approximately 15 seconds when the vehicle security alarm is arming. The light will flash at a slower speed continuously after the alarm is set. The security light will also come on for about three seconds when the ignition is first turned on.

– Cruise Control SET Indicator

This indicator will illuminate when the cruising speed has been set.

– Electronic Stability Control (ESC) OFF Indicator Light

The ESC Off mode is intended for off-highway or off-road use only and should not be used on any public roadways. In this mode, all TCS and ESC stability features are turned OFF. To enter the "Full Off" mode, push and hold the "ESC" switch for five seconds while the vehicle is stopped with the engine running. After five seconds, a chime will sound, the "ESC OFF" Indicator Light" will illuminate, and the "ESC OFF" message will display in the vehicle cluster (left of the odometer). To turn ESC ON again, momentarily push the "ESC" switch.

– Door Open Indicator

This indicator will illuminate when a door(s) is left open and not fully closed.

WHAT TO DO IN EMERGENCIES

IF YOUR ENGINE OVERHEATS

In any of the following situations, you can reduce the potential for overheating by taking the appropriate action.

- **On the highways** — Slow down and use the highest gear possible.
- **In city traffic** — While stopped, put the transmission in NEUTRAL, but do not increase engine idle speed.
- **In city traffic** — While moving, shift into the highest gear possible to reduce engine RPM.

NOTE:

There are steps that you can take to slow down an impending overheat condition:

- If your air conditioner (A/C) is on, turn it off. The A/C system adds heat to the engine cooling system and turning the A/C off can help remove this heat.
- You can also turn the temperature control to maximum heat, the mode control to floor and the blower control to high. This allows the heater core to act as a supplement to the radiator and aids in removing heat from the engine cooling system.

WARNING!

You or others can be badly burned by hot engine coolant (antifreeze) or steam from your radiator. If you see or hear steam coming from under the hood, do not open the hood until the radiator has had time to cool. Never try to open a cooling system pressure cap when the radiator or coolant bottle is hot.

TIRE SERVICE KIT

Your vehicle may be equipped with a Tire Service Kit.

Small punctures up to 1/4" (6 mm) in the tire tread can be sealed with the Tire Service Kit. Foreign objects (e.g., screws or nails) should not be removed from the tire. The Tire Service Kit can be used in outside temperatures down to approximately -4°F (-20°C).

This kit will provide a temporary tire seal, allowing you to drive your vehicle up to 100 miles (160 km) with a maximum speed of 55 mph (90 km/h).

Tire Service Kit Storage

The Tire Service Kit is located in the trunk.

WHAT TO DO IN EMERGENCIES

Tire Service Kit Components And Operation

Using The Mode Select Knob And Hoses

Your Tire Service Kit is equipped with the following symbols to indicate the air or sealant mode.

Selecting Air Mode

Turn the Mode Select Knob (5) to this position for air pump operation only. Use the Black Air Pump Hose (7) when selecting this mode.

Selecting Sealant Mode

Turn the Mode Select Knob (5) to this position to inject the Tire Service Kit Sealant and to inflate the tire. Use the Sealant Hose (clear hose) (6) when selecting this mode.

Using The Power Button

Push and release the Power Button (4) once to turn On the Tire Service Kit. Push and release the Power Button (4) again to turn Off the Tire Service Kit.

Using The Deflation Button

Push the Deflation Button (2) to reduce the air pressure in the tire if it becomes over-inflated.

Tire Service Kit Usage Precautions

- Replace the Tire Service Kit Sealant Bottle (1) and Sealant Hose (6) prior to the expiration date (printed on the bottle label) to assure optimum operation of the system. Refer to "Sealing A Tire With Tire Service Kit" section (F) "Sealant Bottle and Hose Replacement."
- The Sealant Bottle (1) and Sealant Hose (6) are a one tire application use. After each use, always replace these components immediately at an authorized dealer.
- When the Tire Service Kit sealant is in a liquid form, clean water, and a damp cloth will remove the material from the vehicle or tire and wheel components. Once the sealant dries, it can easily be peeled off and properly discarded.
- For optimum performance, make sure the valve stem on the wheel is free of debris before connecting the Tire Service Kit.

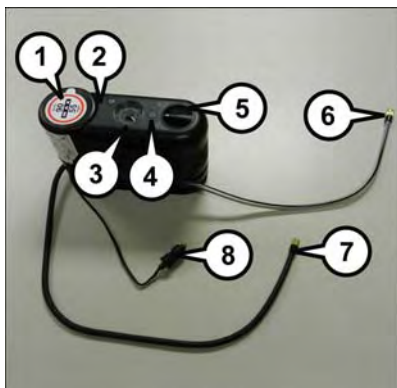

Tire Service Kit Components

- 1 — Sealant Bottle
- 2 — Deflation Button
- 3 — Pressure Gauge
- 4 — Power Button
- 5 — Mode Select Knob
- 6 — Sealant Hose (Clear)
- 7 — Air Pump Hose (Black)
- 8 — Power Plug (located on bottom side of Tire Service Kit)

WHAT TO DO IN EMERGENCIES

- You can use the Tire Service Kit air pump to inflate bicycle tires. The kit also comes with two needles, located in the Accessory Storage Compartment (on the bottom of the air pump) for inflating sport balls, rafts, or similar inflatable items. However, use only the Air Pump Hose (7) and make sure the Mode Select Knob (5) is in the Air Mode when inflating such items to avoid injecting sealant into them. The Tire Service Kit Sealant is only intended to seal punctures less than 1/4 inch (6 mm) diameter in the tread of your vehicle.
- Do not lift or carry the Tire Service Kit by the hoses.

Sealing A Tire With Tire Service Kit

(A) Whenever You Stop To Use Tire Service Kit:

1. Pull over to a safe location and turn on the vehicle's Hazard Warning flashers.
2. Verify that the valve stem (on the wheel with the deflated tire) is in a position that is near to the ground. This will allow the Tire Service Kit Hoses (6) and (7) to reach the valve stem and keep the Tire Service Kit flat on the ground. This will provide the best positioning of the kit when injecting the sealant into the deflated tire and running the air pump. Move the vehicle as necessary to place the valve stem in this position before proceeding.
3. Place the transmission in PARK (auto transmission) or in Gear (manual transmission) and cycle the ignition to the OFF position.
4. Set the parking brake.

(B) Setting Up To Use Tire Service Kit:

1. Turn the Mode Select Knob (5) to the Sealant Mode position.
2. Uncoil the Sealant Hose (6) and then remove the cap from the fitting at the end of the hose.
3. Place the Tire Service Kit flat on the ground next to the deflated tire.
4. Remove the cap from the valve stem and then screw the fitting at the end of the Sealant Hose (6) onto the valve stem.
5. Uncoil the Power Plug (8) and insert the plug into the vehicle's 12 Volt power outlet.
6. Do not remove foreign objects (e.g., screws or nails) from the tire.

(C) Injecting Tire Service Kit Sealant Into The Deflated Tire:

Always start the engine before turning ON the Tire Service Kit.

NOTE:

Manual transmission vehicles must have the parking brake engaged and the gear selector in NEUTRAL.

WHAT TO DO IN EMERGENCIES

After pushing the Power Button (4), the sealant (white fluid) will flow from the Sealant Bottle (1) through the Sealant Hose (6) and into the tire.

NOTE:

Sealant may leak out through the puncture in the tire.

If the sealant (white fluid) does not flow within 0 – 10 seconds through the Sealant Hose (6):

1. Push the Power Button (4) to turn Off the Tire Service Kit. Disconnect the Sealant Hose (6) from the valve stem. Make sure the valve stem is free of debris. Reconnect the Sealant Hose (6) to the valve stem. Check that the Mode Select Knob (5) is in the Sealant Mode position and not Air Mode. Push the Power Button (4) to turn On the Tire Service Kit.
2. Connect the Power Plug (8) to a different 12 Volt power outlet in your vehicle or another vehicle, if available. Make sure the engine is running before turning ON the Tire Service Kit.
3. The Sealant Bottle (1) may be empty due to previous use. Call for assistance.

NOTE:

If the Mode Select Knob (5) is on Air Mode and the pump is operating, air will dispense from the Air Pump Hose (7) only, not the Sealant Hose (6).

If the sealant (white fluid) does flow through the Sealant Hose (6):

1. Continue to operate the pump until sealant is no longer flowing through the hose (typically takes 30 - 70 seconds). As the sealant flows through the Sealant Hose (6), the Pressure Gauge (3) can read as high as 70 psi (4.8 Bar). The Pressure Gauge (3) will decrease quickly from approximately 70 psi (4.8 Bar) to the actual tire pressure when the Sealant Bottle (1) is empty.
2. The pump will start to inject air into the tire immediately after the Sealant Bottle (1) is empty. Continue to operate the pump and inflate the tire to the pressure indicated on the tire pressure label on the driver-side latch pillar (recommended pressure). Check the tire pressure by looking at the Pressure Gauge (3).

If the tire does not inflate to at least 26 psi (1.8 Bar) pressure within 15 minutes:

The tire is too badly damaged. Do not attempt to drive the vehicle further. Call for assistance.

NOTE:

If the tire becomes over-inflated, push the Deflation Button to reduce the tire pressure to the recommended inflation pressure before continuing.

If the tire inflates to the recommended pressure or is at least 26 psi (1.8 Bar) pressure within 15 minutes:

1. Push the Power Button (4) to turn off the Tire Service Kit.
2. Remove the Speed Limit sticker from the top of the Sealant Bottle (1) and place the sticker on the instrument panel.

WHAT TO DO IN EMERGENCIES

3. Immediately disconnect the Sealant Hose (6) from the valve stem, reinstall the cap on the fitting at the end of the hose, and place the Tire Service Kit in the vehicle storage location. Quickly proceed to (D) "Drive Vehicle."

(D) Drive Vehicle:

Immediately after injecting sealant and inflating the tire, drive the vehicle 5 miles (8 km) or 10 minutes to ensure distribution of the Tire Service Kit Sealant within the tire. Do not exceed 55 mph (88 km/h).

(E) After Driving:

Pull over to a safe location. Refer to "Whenever You Stop to Use Tire Service Kit" before continuing.

1. Turn the Mode Select Knob (5) to the Air Mode position.
2. Uncoil the Air Pump Hose (7) (black in color) and screw the fitting at the end of hose (7) onto the valve stem.
3. Uncoil the power plug and insert the plug into the vehicles 12 Volt power outlet.
4. Check the pressure in the tire by reading the Pressure Gauge (3).

If tire pressure is less than 19 psi (1.3 Bar), the tire is too badly damaged. Do not attempt to drive the vehicle further. Call for assistance.

If the tire pressure is 19 psi (1.3 Bar) or higher:

1. Push the Power Button (4) to turn on Tire Service Kit and inflate the tire to the pressure indicated on the tire and loading information label on the driver-side door opening.
2. Disconnect the Tire Service Kit from the valve stem, reinstall the cap on the valve stem and unplug from 12 Volt outlet.
3. Place the Tire Service Kit in its proper storage area in the vehicle.
4. Have the tire inspected and repaired or replaced at the earliest opportunity at an authorized dealer or tire service center.
5. Remove the Speed Limit sticker from the instrument panel after the tire has been repaired.
6. Replace the Sealant Bottle (1) and Sealant Hose (6) assembly at your authorized dealer as soon as possible. Refer to "(F) Sealant Bottle and Hose Replacement."

NOTE:

- If the tire becomes over-inflated, push the Deflation Button to reduce the tire pressure to the recommended inflation pressure before continuing.
- When having the tire serviced, advise the authorized dealer or service center that the tire has been sealed using the Tire Service Kit.

WHAT TO DO IN EMERGENCIES

(F) Sealant Bottle And Hose Replacement:

1. Uncoil the Sealant Hose (6) (clear in color).
2. Locate the round Sealant Bottle release button in the recessed area under the sealant bottle.
3. Push the Sealant Bottle release button. The Sealant Bottle (1) will pop up. Remove the bottle and dispose of it accordingly.
4. Clean any remaining sealant from the Tire Service Kit housing.
5. Position the new Sealant Bottle (1) in the housing so that the Sealant Hose (6) aligns with the hose slot in the front of the housing. Push the bottle into the housing. An audible click will be heard indicating the bottle is locked into place.
6. Verify that the cap is installed on the fitting at the end of the Sealant Hose (6) and return the hose to its storage area (located on the bottom of the air pump).
7. Return the Tire Service Kit to its storage location in the vehicle.

NOTE:

- The metal end fitting from Power Plug (8) may get hot after use, so it should be handled carefully.
- Failure to reinstall the cap on the fitting at the end of the Sealant Hose (6) can result in sealant contacting your skin, clothing, and the vehicle's interior. It can also result in sealant contacting internal Tire Service Kit components which may cause permanent damage to the kit.

WARNING!

- Do not attempt to seal a tire on the side of the vehicle closest to traffic. Pull far enough off the road to avoid the danger of being hit when using the Tire Service Kit.
- Do not use the Tire Service Kit or drive the vehicle under the following circumstances:
 - If the puncture in the tire tread is approximately 1/4". (6 mm) or larger.
 - If the tire has any sidewall damage.
 - If the tire has any damage from driving with extremely low tire pressure.
 - If the tire has any damage from driving on a flat tire.
 - If the wheel has any damage.
 - If you are unsure of the condition of the tire or the wheel.
- Keep the Tire Service Kit away from open flames or heat source.
- A loose Tire Service Kit thrown forward in a collision or hard stop could endanger the occupants of the vehicle. Always stow the Tire Service Kit in the place provided. Failure to follow these warnings can result in injuries that are serious or fatal to you, your passengers, and others around you.

WHAT TO DO IN EMERGENCIES

WARNING!

- Take care not to allow the contents of the Tire Service Kit to come in contact with hair, eyes, or clothing. The Tire Service Kit is harmful if inhaled, swallowed, or absorbed through the skin. It causes skin, eye, and respiratory irritation. Flush immediately with plenty of water if there is any contact with eyes or skin. Change clothing as soon as possible, if there is any contact with clothing.
- The Tire Service Kit Sealant solution contains latex. In case of an allergic reaction or rash, consult a physician immediately. Keep the Tire Service Kit out of reach of children. If swallowed, rinse mouth immediately with plenty of water and drink plenty of water. Do not induce vomiting! Consult a physician immediately.
- The Tire Service Kit is not a permanent flat tire repair. Have the tire inspected and repaired or replaced after using the Tire Service Kit. Do not exceed 55 mph (88 km/h) until the tire is repaired or replaced. Failure to follow this warning can result in injuries that are serious or fatal to you, your passengers, and others around you.

JUMP-STARTING PROCEDURES

WARNING!

- Take care to avoid the radiator cooling fan whenever the hood is raised. It can start anytime the ignition switch is ON. You can be hurt by the fan.
- Do not attempt to push or tow your vehicle to get it started. Unburned fuel could enter the catalytic converter and once the engine has started, ignite and damage the converter and vehicle. If the vehicle has a discharged battery, booster cables may be used to obtain a start from another vehicle. This type of start can be dangerous if done improperly, so follow this procedure carefully.
- Wear eye protection and remove any metal jewelry such as watch bands or bracelets that might make an inadvertent electrical contact. You could be seriously injured.

NOTE:

The battery is located underneath an access panel inside the rear compartment on the left side of the vehicle. A remote battery terminal is located in the engine compartment for jump-starting.

Connecting The Jumper Cables

1. Wear eye protection and remove any metal jewelry such as watchbands or bracelets that might make an inadvertent electrical contact.
2. When boost is provided by a battery in another vehicle, park that vehicle within booster cable reach, but without allowing the vehicles to touch one another.
3. Set the parking brake, place the transmission in NEUTRAL, and turn the ignition OFF on both vehicles.
4. Turn off the heater, radio, and all unnecessary electrical loads.

WHAT TO DO IN EMERGENCIES

5. Remove the plastic fuse cover to gain access to the remote jump-start positive (+) post in the engine compartment. Refer to the following illustration for remote jump-starting connections.



Jump Starting Locations

- 1 — Remote Negative Post
2 — Remote Positive Post

CAUTION!

Failure to follow these procedures could result in damage to the charging system of the booster vehicle or the discharged vehicle.

6. Connect the positive (+) end of the jumper cable to the remote positive (+) post of the discharged vehicle.
7. Connect the opposite end of the positive (+) jumper cable to the positive (+) post of the booster battery.
8. Connect the negative (-) end of the jumper cable to the negative (-) post of the booster battery.
9. Connect the opposite end of the negative (-) jumper cable to the remote negative (-) post of the vehicle with the discharged battery.

WARNING!

Do not connect the jumper cable to the negative (-) post of the discharged battery. The resulting electrical spark could cause the battery to explode and could result in personal injury. Only use the specific ground point, do not use any other exposed metal parts.

10. Start the engine in the vehicle that has the booster battery, let the engine idle a few minutes, and then start the engine in the vehicle with the discharged battery.

WHAT TO DO IN EMERGENCIES

11. Once the engine is started, remove the jumper cables in the reverse sequence:

Disconnecting The Jumper Cables

1. Disconnect the negative (-) end of the jumper cable from the remote negative (-) post of the vehicle with the discharged battery.
2. Disconnect the opposite end of the negative (-) jumper cable from the negative (-) post of the booster battery.
3. Disconnect the positive (+) end of the jumper cable from the positive (+) post of the booster battery.
4. Disconnect the opposite end of the positive (+) jumper cable from the remote positive (+) post of the vehicle with the discharged battery.

If frequent jump-starting is required to start your vehicle you should have the battery and charging system inspected at your authorized dealer.

CAUTION!

Accessories plugged into the vehicle power outlets draw power from the vehicle's battery, even when not in use (i.e., cellular devices, etc.). Eventually, if plugged in long enough without engine operation, the vehicle's battery will discharge sufficiently to degrade battery life and/or prevent the engine from starting.

TOWING A DISABLED VEHICLE

Do not tow with sling-type equipment. This vehicle must be towed with all four wheels OFF the ground using a flatbed. Always comply with applicable state or local towing ordinances.

CAUTION!

- Failure to follow these towing methods can cause severe transmission damage. Such damage is not covered by the New Vehicle Limited Warranty.
- Do not attempt to use sling-type equipment when towing. When securing the vehicle to a flatbed truck, do not attach to front or rear suspension components. Damage to your vehicle may result from improper towing.

WHAT TO DO IN EMERGENCIES

FREEING A STUCK VEHICLE

If your vehicle becomes stuck in mud, sand, or snow, it can often be moved using a rocking motion. Turn your steering wheel right and left to clear the area around the front wheels. Then shift back and forth between 1st gear and REVERSE, while gently pushing the accelerator. Use the least amount of pressure to maintain the rocking motion, without spinning the wheels, or racing the engine.

WARNING!

Fast spinning tires can be dangerous. Forces generated by excessive wheel speeds may cause damage, or even failure, of the axle and tires. A tire could explode and injure someone. Do not spin your vehicle's wheels faster than 30 mph (48 km/h) or for longer than 30 seconds continuously without stopping when you are stuck. And do not let anyone near a spinning wheel, no matter what the speed.

CAUTION!

- When “rocking” a stuck vehicle by shifting between 1st gear and REVERSE, do not spin the wheels faster than 15 mph (24 km/h), or drivetrain damage may result.
- Revving the engine or spinning the wheels too fast may lead to transmission overheating and failure. It can also damage the tires. Do not spin the wheels above 30 mph (48 km/h) while in gear (no transmission shifting occurring).

ENHANCED ACCIDENT RESPONSE SYSTEM (EARS)

This vehicle is equipped with an Enhanced Accident Response System.

Please refer to “Supplemental Restraint System (SRS) — Air Bags” in “Occupant Restraints” for further information on the Enhanced Accident Response System (EARS) function.



WHAT TO DO IN EMERGENCIES

EVENT DATA RECORDER (EDR)

This vehicle is equipped with an Event Data Recorder (EDR). The main purpose of an EDR is to record, in certain crash or near crash-like situations, such as an air bag deployment or hitting a road obstacle, data that will assist in understanding how a vehicle's systems performed.

Please refer to “Supplemental Restraint System (SRS) — Air Bags” in “Occupant Restraints” for further information on the Event Data Recorder (EDR).

MAINTAINING YOUR VEHICLE

TO OPEN AND CLOSE THE HOOD



Hood Release Lever Location

1. Reach into the back side area of the drivers front fender to gain access to the hood release lever.
2. Pull the hood release lever rearward to release the hood latches.
3. Lift the hood upward to the full forward position.

NOTE:

The recommended lift point is to place the lifting hand forward of one of the wiper arms and pull up. The assist props will help raise and hold the hood to a normal usage position.

WARNING!

Be sure the hood is fully latched before driving your vehicle. If the hood is not fully latched, it could open when the vehicle is in motion and block your vision. Failure to follow this warning could result in serious injury or death.

CAUTION!

- Do not leave the hood open in areas where strong gust of wind are likely. Such a place might be by the side of the road where large trucks pass by. Strong gusts of wind may damage the hood. Always close the hood in such situations.
- To prevent possible damage, do not slam the hood to close it. Simply lower the hood until it is open approximately 18 in (46 cm) and then drop it. This should secure both latches. If both latches did not secure, a slight push effort in the same area used for opening the hood (front of wiper arm) needs to be applied to secure the latches. Never drive the vehicle unless the hood is fully closed with both latches engaged.

MAINTAINING YOUR VEHICLE



ENGINE COMPARTMENT — 8.4L

1. Windshield Washer Fluid
2. Engine Coolant Reservoir Cap
3. Engine Coolant Reservoir
4. Oil Dipstick
5. Air Cleaner Filter

MAINTAINING YOUR VEHICLE

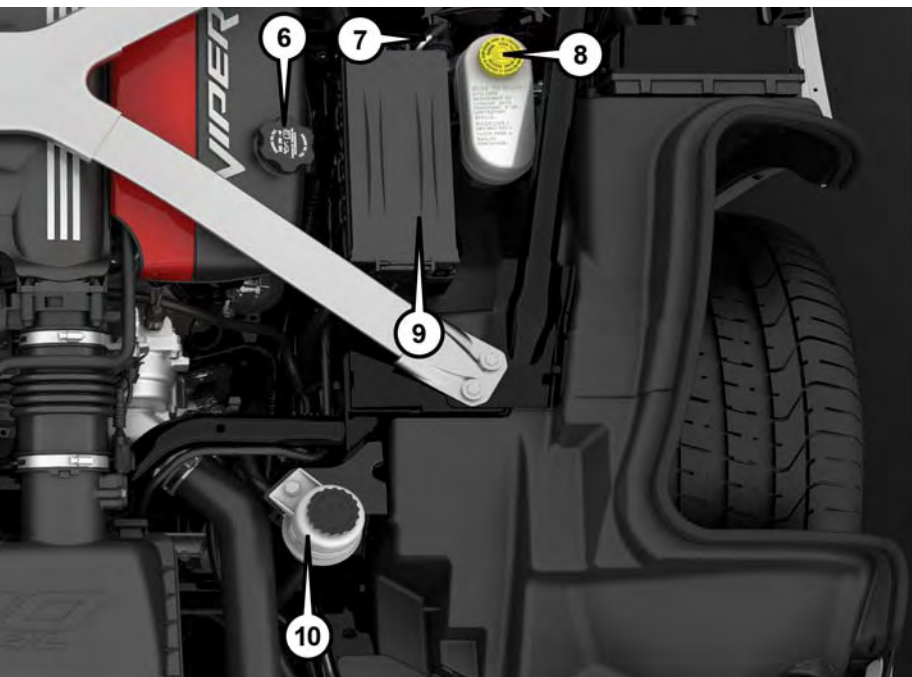

6. Engine Oil Fill
7. Remote Jump Start Positive Battery Post (Under Cover)
8. Brake/Clutch Fluid Reservoir Engine
9. Power Distribution Center (Fuses)
10. Power Steering Fluid Reservoir

MAINTAINING YOUR VEHICLE

FLUID CAPACITIES

	U.S.	Metric
Fuel (Approximate)	16 Gallons	60.6 Liters
Engine Oil With Filter		
We recommend you use synthetic SAE 0W-40, API Certified.	11 Quarts	10.4 Liters
Transmission		
We recommend you use MOPAR ATF+4 Automatic Transmission Fluid.	3.4 Quarts	3.2 Liters
Rear Axle		
We recommend you use Castrol SAF-XJ/SAE 75W-140 Synthetic Gear and Axle Lubricant.	1.5 Quarts	1.4 Liters
Cooling System *		
We recommend you use MOPAR Antifreeze/Engine Coolant (OAT coolant conforming to MS.90032) 10 Year/150,000 Mile Formula or equivalent).	16 Quarts	15 Liters
* Includes heater and coolant recovery bottle filled to MAX level.		

FLUIDS, LUBRICANTS, AND GENUINE PARTS

Engine

Component	Fluid, Lubricant, or Genuine Part
Engine Coolant	We recommend you use MOPAR Antifreeze/Coolant 10 Year/150,000 Mile Formula OAT coolant conforming to MS.90032.
Engine Oil	We recommend you use a full synthetic 0W-40 engine oil such as MOPAR or Pennzoil Ultra or equivalent engine oil.
Engine Oil Filter	We recommend you use MOPAR Engine Oil Filters.
Spark Plugs	We recommend you use MOPAR Spark Plugs.
Fuel Selection	We recommend you use Unleaded 91 Octane Only or Higher, 0-10% Ethanol.

CAUTION!

- Mixing of engine coolant (antifreeze) other than specified Organic Additive Technology (OAT) engine coolant (antifreeze), may result in engine damage and may decrease corrosion protection. Organic Additive Technology (OAT) engine coolant is different and should not be mixed with Hybrid Organic Additive Technology (HOAT) engine coolant (antifreeze) or any “globally compatible” coolant (antifreeze). If a non-OAT engine coolant (antifreeze) is introduced into the cooling system in an emergency, the cooling system will need to be drained, flushed, and refilled with fresh OAT coolant (conforming to MS.90032), by an authorized dealer as soon as possible.
- Do not use water alone or alcohol-based engine coolant (antifreeze) products. Do not use additional rust inhibitors or antirust products, as they may not be compatible with the radiator engine coolant and may plug the radiator.
- This vehicle has not been designed for use with propylene glycol-based engine coolant (antifreeze). Use of propylene glycol-based engine coolant (antifreeze) is not recommended.

Chassis

Component	Fluid, Lubricant, or Genuine Part
Transmission	We recommend you use MOPAR ATF+4 Automatic Transmission Fluid.
Rear Axle	We recommend you use Castrol SAF-XJ/SAE 75W-140 Synthetic Gear and Axle Lubricant.
Brake/Clutch Master Cylinder	We recommend you use MOPAR Brake and Clutch Fluid DOT 4 Motor Vehicle.
Power Steering Reservoir	We recommend you use MOPAR Power Steering Fluid + 4, MOPAR or ATF+4 Automatic Transmission Fluid.

MAINTAINING YOUR VEHICLE

ADDING FUEL

1. Push the fuel filler door release switch (located in the driver's door map pocket).
2. Open the fuel filler door.
3. There is no fuel filler cap. A flapper door inside the pipe seals the system.
4. Insert the fuel nozzle fully into the filler pipe – the nozzle opens and holds the flapper door while refueling.

NOTE:

Only the correct size nozzle opens the latches allowing the flapper door to open.

5. Fill the vehicle with fuel – when the fuel nozzle “clicks” or shuts off, the fuel tank is full.
6. Remove the fuel nozzle and close the fuel door.



Fuel Filler

NOTE:

A funnel is provided (located in the trunk in the spare tire area) to open the flapper door to allow for emergency refueling with a gas can.

WARNING!

- Never have any smoking materials lit in or near the vehicle when the fuel door is open or the tank is being filled.
- Never add fuel when the engine is running. This is in violation of most state and federal fire regulations and may cause the “Malfunction Indicator Light” to turn on.
- A fire may result if fuel is pumped into a portable container that is inside of a vehicle. You could be burned. Always place fuel containers on the ground while filling.

CAUTION!

To avoid fuel spillage and overfilling, do not “top off” the fuel tank after filling.

MAINTAINING YOUR VEHICLE

Materials Added To Fuel



Designated TOP TIER Detergent Gasoline contains a higher level of detergents to further aid in minimizing engine and fuel system deposits. When available, the usage of Top Tier Detergent gasoline is recommended. Visit www.toptiergas.com for a list of TOP TIER Detergent Gasoline Retailers.

Indiscriminate use of fuel system cleaning agents should be avoided.

Many of these materials intended for gum and varnish removal may contain active solvents or similar ingredients. These can harm fuel system gasket and diaphragm materials.

MAINTENANCE PROCEDURES

For information on the maintenance procedures for your vehicle, please refer to "Maintenance Procedures" in "Maintaining Your Vehicle" in your Owner's Manual or applicable supplement on the DVD for further details.

MAINTENANCE SCHEDULES

The Scheduled Maintenance services listed in this manual must be done at the times or mileages specified to protect your vehicle warranty and ensure the best vehicle performance and reliability. More frequent maintenance may be needed for vehicles in severe operating conditions, such as dusty areas and very short trip driving. Inspection and service should also be done anytime a malfunction is suspected.

NOTE:

Under no circumstances should oil change intervals exceed 6,000 miles (10 000 km) or six months, whichever comes first.

CAUTION!

Failure to perform the required maintenance items may result in damage to the vehicle.



MAINTAINING YOUR VEHICLE

At Each Stop For Fuel

- Check the engine oil level about five minutes after a fully warmed engine is shut off. Checking the oil level while the vehicle is on level ground will improve the accuracy of the oil level reading. Add oil only when the level is at or below the ADD or MIN mark.
- Check the windshield washer solvent, and add if required.

Once A Month

- Check tire pressure and look for unusual wear or damage. Rotate tires at the first sign of irregular wear, even if it occurs before your next scheduled service.
- Inspect the battery, and clean and tighten the terminals as required.
- Check the fluid levels of the coolant reservoir, brake master cylinder, power steering, and transmission, and add as needed.
- Check all lights and all other electrical items for correct operation.

At Each Oil Change

- Change the engine oil filter.
- Inspect the exhaust system.

NOTE:

Also, inspect the exhaust system if you notice a change in the sound of the exhaust system, or if the exhaust fumes can be detected inside the vehicle.

- Inspect the brake hoses.
- Inspect the suspension components.
- Lubricate door hinges and check springs.
- Check the engine coolant level, hoses, and clamps.
- Check power steering fluid level.

MAINTENANCE CHART

Miles:	6	12	18	24	30	36	42	48	54	60	66	72	78	84	90	96	102	108	114	120	126	132	138	144	150,000
Or Months:	10,000	20,000	30,000	40,000	50,000	60,000	70,000	80,000	90,000	100,000	110,000	120,000	130,000	140,000	150,000	160,000	170,000	180,000	190,000	200,000	210,000	220,000	230,000	240,000	250,000
Or Kilometers:	10,000	20,000	30,000	40,000	50,000	60,000	70,000	80,000	90,000	100,000	110,000	120,000	130,000	140,000	150,000	160,000	170,000	180,000	190,000	200,000	210,000	220,000	230,000	240,000	250,000
Change the engine oil and engine oil filter.	X	X	X	X	X	X	X	X	X	X	X	X	X	X	X	X	X	X	X	X	X	X	X	X	X
Inspect the brake linings; replace if necessary.		X		X		X		X		X		X		X		X		X		X		X		X	
Rotate the tires, rotate at the first sign of irregular wear, even if it occurs before scheduled maintenance.	X	X	X	X	X	X	X	X	X	X	X	X	X	X	X	X	X	X	X	X	X	X	X	X	X
Inspect the exhaust system.		X		X		X		X		X		X		X		X		X		X		X		X	
Change Brake Fluid. *				X				X				X				X				X			X		
Adjust the parking brake on vehicles equipped with four wheel disc brakes.					X					X					X					X				X	
Change the manual transmission fluid.						X					X							X						X	
Inspect the manual transmission fluid, add as necessary.		X		X				X		X				X		X				X		X			
Change the rear axle fluid.			X			X			X			X			X			X			X			X	
Inspect front suspension, tie rod ends, and boot seals, for cracks or leaks and all parts for damage, wear, improper looseness or end play; replace if necessary.		X		X		X		X		X		X		X		X		X		X		X		X	

MAINTAINING YOUR VEHICLE

Miles:	6,000	12,000	18,000	24,000	30,000	36,000	42,000	48,000	54,000	60,000	66,000	72,000	78,000	84,000	90,000	96,000	102,000	108,000	114,000	120,000	126,000	132,000	138,000	144,000	150,000
Or Months:	6	12	18	24	30	36	42	48	54	60	66	72	78	84	90	96	102	108	114	120	126	132	138	144	150
Or Kilometers:	10,000	20,000	30,000	40,000	50,000	60,000	70,000	80,000	90,000	100,000	110,000	120,000	130,000	140,000	150,000	160,000	170,000	180,000	190,000	200,000	210,000	220,000	230,000	240,000	250,000
Replace the engine air cleaner.				X						X					X										X
Inspect and replace the PCV Valve if necessary.															X										
Replace the spark plugs. **																X									
Flush and replace the engine coolant at 120 months if not done at 150,000 miles (240,000 km).																				X					X

* The brake fluid change interval is time based only, mileage intervals do not apply.

** The spark plug change interval is mileage based only, monthly intervals do not apply.

WARNING!

- You can be badly injured working on or around a motor vehicle. Do only service work for which you have the knowledge and the right equipment. If you have any doubt about your ability to perform a service job, take your vehicle to a competent mechanic.
- Failure to properly inspect and maintain your vehicle could result in a component malfunction and effect vehicle handling and performance. This could cause an accident.

SRT – MAINTENANCE RECORD

	Odometer	Date	Signature, Authorized Service Center
6,000 Miles (10,000 km) or 6 Months			
12,000 Miles (20,000 km) or 12 Months			
18,000 Miles (30,000 km) or 18 Months			
24,000 Miles (40,000 km) or 24 Months			
30,000 Miles (50,000 km) or 30 Months			
36,000 Miles (60,000 km) or 36 Months			
42,000 Miles (70,000 km) or 42 Months			

	Odometer	Date	Signature, Authorized Service Center
48,000 Miles (80,000 km) or 48 Months			
54,000 Miles (90,000 km) or 54 Months			
60,000 Miles (100,000 km) or 60 Months			
66,000 Miles (110,000 km) or 66 Months			
72,000 Miles (120,000 km) or 72 Months			
78,000 Miles (130,000 km) or 78 Months			

MAINTAINING YOUR VEHICLE

FUSES

Power Distribution Center

The Power Distribution Center is located in the engine compartment on the driver's side of the vehicle. This center contains fuses and relays.

Cavity	Relay	Cartridge Fuse	Mini-Fuse	Description
3	—	40 Amp Green	—	Rad Fan
4	—	40 Amp Green	—	Rad Fan Rly High
5	—	40 Amp Green	—	ABS/ESP Pump Feed
6	—	40 Amp Green	—	Starter
7	—	40 Amp Green	—	CBC (Ext. Lighting #1)
8	—	40 Amp Green	—	CBC (Ext. Lighting #2)
9	—	30 Amp Pink	—	CBC (Lighting, Washer Pump)
10	—	30 Amp Pink	—	CBC (Power Lock)
11	—	Jumper Black	—	B+ Jumper
12	—	25 Amp Clear	—	ABS/ESP Valve Feed
13	—	—	20 Amp Yellow	Horn
14	—	—	10 Amp Red	A/C Clutch
15	—	—	10 Amp Red	Diagnostic, Fuel Door, Stop Switch
16	—	—	15 Amp Blue	KIN, RF Hub
17	—	—	25 Amp circuit breaker	Power Seats
18	—	30 Amp Pink	—	Driver Door Mod
19	—	30 Amp Pink	—	Passenger Door Mod
20	—	30 Amp Pink	—	Rear Window Defroster
21	—	20 Amp Blue	—	Wiper
22	—	Jumper Black	—	B+ Jumper
23	—	—	15 Amp Blue	HVAC MOD, Cluster, ICS-Switch Bank
24	—	—	25 Amp Clear	PCM-Powertrain Control Module

MAINTAINING YOUR VEHICLE

Cavity	Relay	Cartridge Fuse	Mini-Fuse	Description
25	—	—	25 Amp Clear	Fuel Pump
26	—	—	20 Amp Yellow	ASD #1
27	—	—	20 Amp Yellow	ASD #2
28	—	—	—	Not Used
29	—	40 Amp Green	—	HVAC Blower
30	—	20 Amp Blue	—	RR Power Outlet, Adj. Pedals, UCI
31	—	Jumper Black	—	B+ Jumper
32	—	—	—	Not Used
33	—	20 Amp Blue	—	Run Acc Relay
34	—	Jumper Black	—	B+ Jumper
35	—	—	—	Not Used
36	—	—	10 Amp Red	ORC Mod Run
37	—	—	15 Amp Blue	Cluster, Camera
38	—	—	20 Amp Yellow	Active Damping Suspension
39	—	—	10 Amp Red	HVAC Module, In Vehicle Temp, Blower Relay
40	—	—	—	Not Used
41	G8VA	—	—	Run/Start
42	G8VA	—	—	Fuel Door
43AC (Forward Fuse)	—	—	2 Amp Grey	SCCM
43BE (Rearward Fuse)	—	—	10 Amp Red	Tire Pressure Module
44AC (Forward Fuse)	—	—	10 Amp Red	Rear View Mirror, Aux Port Jumper
44BE (Rearward Fuse)	—	—	10 Amp Red	Intelligent Battery Sensor
45	—	—	10 Amp Red	PCM-Powertrain Control Module, Fuel Pump Relay
46	—	—	10 Amp Red	ESC Module, Stop Lamp Switch
47	—	—	10 Amp Red	ORC Module, Passenger Seat OCM
48	—	—	10 Amp Red	SCCM

MAINTAINING YOUR VEHICLE

Cavity	Relay	Cartridge Fuse	Mini-Fuse	Description
49	—	—	25 Amp Clear	Amplifier
50	HC Micro	—	—	Rad Fan
51	HC Micro	—	—	Rad Fan Relay SER/PAR
52	HC Micro	—	—	Starter Relay
53	HC Micro	—	—	Rear Window Defroster Relay
54	HC Relay	—	—	Rad Fan Relay High
55	HC Micro	—	—	Wiper ON/OFF
56	HC Micro	—	—	Wiper LO/HI
57	G8VA	—	—	Horn Relay
58	G8VA	—	—	A/C Clutch Relay
59	HC Micro	—	—	HVAC Blower
60	HC Micro	—	—	Fuel Pump
61	G8VA	—	—	Run Relay #1
62	G8VA	—	—	Run Relay #2
63	HC Micro	—	—	ASD #1
64	HC Micro	—	—	ASD #2
65	G8VA	—	—	Run Accy #1, Pop Up, Driver Door Window Switch
66	—	—	—	Not Used

NOTE:

A 15 Amp fuse for the radio system is located in-line at the battery positive terminal.

CAUTION!

- When installing the power distribution center cover, it is important to ensure the cover is properly positioned and fully latched. Failure to do so may allow water to get into the power distribution center and possibly result in an electrical system failure.
- When replacing a blown fuse, it is important to use only a fuse having the correct amperage rating. The use of a fuse with a rating other than indicated may result in a dangerous electrical system overload. If a properly rated fuse continues to blow, it indicates a problem in the circuit that must be corrected.

MAINTAINING YOUR VEHICLE

TIRE SAFETY INFORMATION

Tire Markings

NOTE:

- P (Passenger) — Metric tire sizing is based on U.S. design standards. P-Metric tires have the letter “P” molded into the sidewall preceding the size designation. Example: P215/65R15 95H.
- European — Metric tire sizing is based on European design standards. Tires designed to this standard have the tire size molded into the sidewall beginning with the section width. The letter “P” is absent from this tire size designation. Example: 215/65R15 96H.
- LT (Light Truck) — Metric tire sizing is based on U.S. design standards. The size designation for LT-Metric tires is the same as for P-Metric tires except for the letters “LT” that are molded into the sidewall preceding the size designation. Example: LT235/85R16.
- Temporary spare tires are designed for temporary emergency use only. Temporary high pressure compact spare tires have the letter “T” or “S” molded into the sidewall preceding the size designation. Example: T145/80D18 103M.
- High flotation tire sizing is based on U.S. design standards and it begins with the tire diameter molded into the sidewall. Example: 31x10.5 R15 LT.

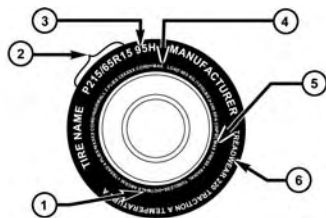

054903773

- | | |
|--|--|
| 1 — U.S. DOT Safety Standards Code (TIN) | 4 — Maximum Load |
| 2 — Size Designation | 5 — Maximum Pressure |
| 3 — Service Description | 6 — Treadwear, Traction and Temperature Grades |

Tire Sizing Chart

EXAMPLE:

Example Size Designation: P215/65R15XL 95H, 215/65R15 96H, LT235/85R16C, T145/80D18 103M, 31x10.5 R15 LT

P = Passenger car tire size based on U.S. design standards, or

"...blank..." = Passenger car tire based on European design standards, or

LT = Light truck tire based on U.S. design standards, or

T or S = Temporary spare tire or

31 = Overall diameter in inches (in)

215, 235, 145 = Section width in millimeters (mm)

65, 85, 80 = Aspect ratio in percent (%)

– Ratio of section height to section width of tire, or

10.5 = Section width in inches (in)

MAINTAINING YOUR VEHICLE

EXAMPLE:

R = Construction code

- "R" means radial construction, or
- "D" means diagonal or bias construction

15, 16, 18 = Rim diameter in inches (in)

Service Description:

95 = Load Index

- A numerical code associated with the maximum load a tire can carry

H = Speed Symbol

- A symbol indicating the range of speeds at which a tire can carry a load corresponding to its load index under certain operating conditions
- The maximum speed corresponding to the speed symbol should only be achieved under specified operating conditions (i.e., tire pressure, vehicle loading, road conditions, and posted speed limits)

Load Identification:

Absence of the following load identification symbols on the sidewall of the tire indicates a Standard Load (SL) tire:

- **XL** = Extra load (or reinforced) tire, or
- **LL** = Light load tire or
- **C, D, E, F, G** = Load range associated with the maximum load a tire can carry at a specified pressure

Maximum Load – Maximum load indicates the maximum load this tire is designed to carry

Maximum Pressure – Maximum pressure indicates the maximum permissible cold tire inflation pressure for this tire

Tire Identification Number (TIN)

The TIN may be found on one or both sides of the tire, however, the date code may only be on one side. Tires with white sidewalls will have the full TIN, including the date code, located on the white sidewall side of the tire. Look for the TIN on the outboard side of black sidewall tires as mounted on the vehicle. If the TIN is not found on the outboard side, then you will find it on the inboard side of the tire.

EXAMPLE:

DOT MA L9 ABCD 0301

DOT = Department of Transportation

- This symbol certifies that the tire is in compliance with the U.S. Department of Transportation tire safety standards and is approved for highway use

MA = Code representing the tire manufacturing location (two digits)

L9 = Code representing the tire size (two digits)

ABCD = Code used by the tire manufacturer (one to four digits)

03 = Number representing the week in which the tire was manufactured (two digits)

- 03 means the 3rd week

01 = Number representing the year in which the tire was manufactured (two digits)

MAINTAINING YOUR VEHICLE

EXAMPLE:
DOT MA L9 ABCD 0301
<ul style="list-style-type: none">- 01 means the year 2001- Prior to July 2000, tire manufacturers were only required to have one number to represent the year in which the tire was manufactured. Example: 031 could represent the 3rd week of 1981 or 1991

Tire Terminology And Definitions

Term	Definition
B-Pillar	The vehicle B-Pillar is the structural member of the body located behind the front door.
Cold Tire Inflation Pressure	Cold tire inflation pressure is defined as the tire pressure after the vehicle has not been driven for at least three hours, or driven less than 1 mile (1.6 km) after sitting for a minimum of three hours. Inflation pressure is measured in units of PSI (pounds per square inch) or kPa (kilopascals).
Maximum Inflation Pressure	The maximum inflation pressure is the maximum permissible cold tire inflation pressure for this tire. The maximum inflation pressure is molded into the sidewall.
Recommended Cold Tire Inflation Pressure	Vehicle manufacturer's recommended cold tire inflation pressure as shown on the tire placard.
Tire Placard	A label permanently attached to the vehicle describing the vehicle's loading capacity, the original equipment tire sizes and the recommended cold tire inflation pressures.

MAINTAINING YOUR VEHICLE

Tire Loading And Tire Pressure

Tire And Loading Information Placard Location

NOTE:

The proper cold tire inflation pressure is listed on the driver's side B-Pillar or the rear edge of the driver's side door.

Check the inflation pressure of each tire, including the spare tire (if equipped), at least monthly and inflate to the recommended pressure for your vehicle.

NOTE:

Refer to the Owner's Manual on the DVD or the Tire Information Supplement located in your Owner's Information kit for more information regarding tire warnings and instructions.



Example Tire Placard Location (Door)



Example Tire Placard Location (B-Pillar)

MAINTAINING YOUR VEHICLE

WARNING!

- Overloading of your tires is dangerous. Overloading can cause tire failure, affect vehicle handling, and increase your stopping distance. Use tires of the recommended load capacity for your vehicle. Never overload them.
- Improperly inflated tires are dangerous and can cause collisions. Under-inflation increases tire flexing and can result in over-heating and tire failure. Over-inflation reduces a tire's ability to cushion shock. Objects on the road and chuck holes can cause damage that results in tire failure. Unequal tire pressures can cause steering problems. You could lose control of your vehicle. Over-inflated or under-inflated tires can affect vehicle handling and can fail suddenly, resulting in loss of vehicle control. Always drive with each tire inflated to the recommended cold tire inflation pressure.

Tire And Loading Information Placard

This placard tells you important information about the:

1. Number of people that can be carried in the vehicle.
2. Total weight your vehicle can carry.
3. Tire size designed for your vehicle.
4. Cold tire inflation pressures for the front, rear, and spare tires.

TIRE AND LOADING INFORMATION			
SEATING CAPACITY - TOTAL 5 FRONT 2 REAR 3			
THE COMBINED WEIGHT OF OCCUPANTS AND CARGO SHOULD NEVER EXCEED XXX KG OR XXX LBS.			
TIRE	FRONT	REAR	SPARE
ORIGINAL TIRE SIZE:	P195/70R14	P195/70R14	T125/70D15
COLD TIRE INFLATION PRESSURE	200kPa, 29PSI	200kPa, 29PSI	420kPa, 60PSI
SEE OWNER'S MANUAL FOR ADDITIONAL INFORMATION			4N109268

811b5a9a

Tire And Loading Information Placard

Loading

The vehicle maximum load on the tire must not exceed the load carrying capacity of the tire on your vehicle. You will not exceed the tire's load carrying capacity if you adhere to the loading conditions, tire size, and cold tire inflation pressures specified on the Tire and Loading Information placard in "Vehicle Loading" in the "Starting And Operating" section of the Owner's Manual on the DVD.

NOTE:

Under a maximum loaded vehicle condition, gross axle weight ratings (GAWRs) for the front and rear axles must not be exceeded. For further information on GAWRs, vehicle loading, and trailer towing, refer to "Vehicle Loading" in the "Starting And Operating" section of the Owner's Manual on the DVD.

To determine the maximum loading conditions of your vehicle, locate the statement "The combined weight of occupants and cargo should never exceed XXX kg or XXX lbs" on the Tire and Loading Information placard. The combined weight of occupants, cargo/luggage and trailer tongue weight (if applicable) should never exceed the weight referenced here.

MAINTAINING YOUR VEHICLE

Steps For Determining Correct Load Limit—

- (1) Locate the statement “The combined weight of occupants and cargo should never exceed XXX kg or XXX lbs.” on your vehicle's placard.
- (2) Determine the combined weight of the driver and passengers that will be riding in your vehicle.
- (3) Subtract the combined weight of the driver and passengers from XXX kg or XXX lbs.
- (4) The resulting figure equals the available amount of cargo and luggage load capacity. For example, if “XXX” amount equals 1400 lbs. and there will be five 150 lb passengers in your vehicle, the amount of available cargo and luggage load capacity is 650 lbs. ($1400 - 750 (5 \times 150) = 650$ lbs.)
- (5) Determine the combined weight of luggage and cargo being loaded on the vehicle. That weight may not safely exceed the available cargo and luggage load capacity calculated in Step 4.
- (6) If your vehicle will be towing a trailer, load from your trailer will be transferred to your vehicle. Consult this manual to determine how this reduces the available cargo and luggage load capacity of your vehicle.

Metric Example For Load Limit

For example, if “XXX” amount equals 635 kg and there will be five 68 kg passengers in your vehicle, the amount of available cargo and luggage load capacity is 295 kg ($635 - 340 (5 \times 68) = 295$ kg) as shown in step 4.

NOTE:

- If your vehicle will be towing a trailer, load from your trailer will be transferred to your vehicle. The following table shows examples on how to calculate total load, cargo/luggage, and towing capacities of your vehicle with varying seating configurations and number and size of occupants. This table is for illustration purposes only and may not be accurate for the seating and load carry capacity of your vehicle.
- For the following example, the combined weight of occupants and cargo should never exceed 865 lbs (392 kg).

MAINTAINING YOUR VEHICLE

Occupants			Combined weight of occupants and cargo from Tire Placard	MINUS	Combined Occupant's weight	=	AVAILABLE Cargo/Luggage and Trailer Tongue Weight
TOTAL	FRONT	REAR					
EXAMPLE 1							
5	2	3	865 lbs	minus	670 lbs	=	195 lbs
EXAMPLE 2							
3	2	1	865 lbs	minus	540 lbs	=	325 lbs
EXAMPLE 3							
2	2	0	865 lbs	minus	400 lbs	=	465 lbs

811a4d11

WARNING!

Overloading of your tires is dangerous. Overloading can cause tire failure, affect vehicle handling, and increase your stopping distance. Use tires of the recommended load capacity for your vehicle. Never overload them.

TIRES — GENERAL INFORMATION

Summer/Three-Season Tires

- This vehicle may be equipped with wheels and tires to enhance traction in both wet and dry conditions.
- Summer tires are not intended to be driven in snow or on ice.
- Summer tires have significantly reduced grip in temperatures below 50°F (10°C).
- Use Summer tires only in sets of four.

NOTE:

Summer tires will not contain the all season designation or mountain/snowflake symbol on the sidewall of the tire.

WARNING!

Do not use summer tires in snow/ice conditions. You could lose control, resulting in severe injury or death. Driving too fast for conditions also creates the possibility of loss of vehicle control.

MAINTAINING YOUR VEHICLE

Spare Tires — If Equipped

NOTE:

For vehicles equipped with Tire Service Kit instead of a spare tire, please refer to the “Tire Service Kit” section located in your Owner’s Information kit for further information.

CAUTION!

Because of the reduced ground clearance, do not take your vehicle through an automatic car wash with a compact or limited-use temporary spare installed. Damage to the vehicle may result.

Spare Tire Matching Original Equipped Tire And Wheel — If Equipped

Your vehicle may be equipped with a spare tire and wheel equivalent in look and function to the original equipment tire and wheel found on the front or rear axle of your vehicle. This spare tire may be used in the tire rotation for your vehicle. If your vehicle has this option, refer to an authorized tire dealer for the recommended tire rotation pattern.

Compact Spare Tire — If Equipped

The compact spare is for temporary emergency use only. You can identify if your vehicle is equipped with a compact spare by looking at the spare tire description on the Tire and Loading Information Placard located on the driver’s side door opening or on the sidewall of the tire. Compact spare tire descriptions begin with the letter “T” or “S” preceding the size designation. Example: T145/80D18 103M.

T, S = Temporary Spare Tire

Since this tire has limited tread life, the original equipment tire should be repaired (or replaced) and reinstalled on your vehicle at the first opportunity.

Do not install a wheel cover or attempt to mount a conventional tire on the compact spare wheel, since the wheel is designed specifically for the compact spare tire. Do not install more than one compact spare tire and wheel on the vehicle at any given time.

WARNING!

Compact and Collapsible spares are for temporary emergency use only. With these spares, do not drive more than 50 mph (80 km/h). Temporary use spares have limited tread life. When the tread is worn to the tread wear indicators, the temporary use spare tire needs to be replaced. Be sure to follow the warnings, which apply to your spare. Failure to do so could result in spare tire failure and loss of vehicle control.

MAINTAINING YOUR VEHICLE

Full Size Spare — If Equipped

The full size spare is for temporary emergency use only. This tire may look like the originally equipped tire on the front or rear axle of your vehicle, but it is not. This spare tire may have limited tread life. When the tread is worn to the tread wear indicators, the temporary use full size spare tire needs to be replaced. Since it is not the same as your original equipment tire, replace (or repair) the original equipment tire and reinstall on the vehicle at the first opportunity.

Limited Use Spare — If Equipped

The limited use spare tire is for temporary emergency use only. This tire is identified by a label located on the limited use spare wheel. This label contains the driving limitations for this spare. This tire may look like the original equipped tire on the front or rear axle of your vehicle, but it is not. Installation of this limited use spare tire affects vehicle handling. Since it is not the same as your original equipment tire, replace (or repair) the original equipment tire and reinstall on the vehicle at the first opportunity.

WARNING!

Limited use spares are for emergency use only. Installation of this limited use spare tire affects vehicle handling. With this tire, do not drive more than the speed listed on the limit use spare wheel. Keep inflated to the cold tire inflation pressures listed on your Tire and Loading Information Placard located on the driver's side B-Pillar or the rear edge of the driver's side door. Replace (or repair) the original equipment tire at the first opportunity and reinstall it on your vehicle. Failure to do so could result in loss of vehicle control.

Wheel And Wheel Trim Care

All wheels and wheel trim, especially aluminum and chrome plated wheels, should be cleaned regularly using mild (neutral Ph) soap and water to maintain their luster and to prevent corrosion. Wash wheels with the same soap solution recommended for the body of the vehicle.

Your wheels are susceptible to deterioration caused by salt, sodium chloride, magnesium chloride, calcium chloride, etc., and other road chemicals used to melt ice or control dust on dirt roads. Use a soft cloth or sponge and mild soap to wipe away promptly. Do not use harsh chemicals or a stiff brush. They can damage the wheel's protective coating that helps keep them from corroding and tarnishing.

NOTE:

Many aftermarket wheel cleaners contain strong acids or strong alkaline additives that can harm the wheel surface.

MAINTAINING YOUR VEHICLE

CAUTION!

Avoid products or automatic car washes that use acidic solutions or strong alkaline additives or harsh brushes. These products and automatic car washes may damage the wheel's protective finish. Such damage is not covered by the New Vehicle Limited Warranty. Only car wash soap, MOPAR Wheel Cleaner or equivalent is recommended.

When cleaning extremely dirty wheels including excessive brake dust, care must be taken in the selection of tire and wheel cleaning chemicals and equipment to prevent damage to the wheels. Mopar Wheel Treatment or Mopar Chrome Cleaner or their equivalent is recommended or select a non-abrasive, non-acidic cleaner for aluminum or chrome wheels. Do not use any products on Dark Vapor or Black Satin Chrome Wheels. They will permanently damage this finish and such damage is not covered by the New Vehicle Limited Warranty.

CAUTION!

Do not use scouring pads, steel wool, a bristle brush, metal polishes or oven cleaner. These products may damage the wheel's protective finish. Such damage is not covered by the New Vehicle Limited Warranty. Only car wash soap, MOPAR Wheel Cleaner or equivalent is recommended.

NOTE:

If you intend parking or storing your vehicle for an extended period after cleaning the wheels with wheel cleaner, drive your vehicle for a few minutes before doing so. Driving the vehicle and applying the brakes when stopping will reduce the risk of brake rotor corrosion.

Dark Vapor Or Black Satin Chrome Wheels

CAUTION!

If your vehicle is equipped with Dark Vapor or Black Satin Chrome wheels DO NOT USE wheel cleaners, abrasives or polishing compounds. They will permanently damage this finish and such damage is not covered by the New Vehicle Limited Warranty. USE ONLY MILD SOAP AND WATER WITH A SOFT CLOTH. Used on a regular basis this is all that is required to maintain this finish.

MAINTAINING YOUR VEHICLE

DEPARTMENT OF TRANSPORTATION UNIFORM TIRE QUALITY GRADES

The following tire grading categories were established by the National Highway Traffic Safety Administration. The specific grade rating assigned by the tire's manufacturer in each category is shown on the sidewall of the tires on your vehicle.

All passenger vehicle tires must conform to Federal safety requirements in addition to these grades.

Treadwear

The Treadwear grade is a comparative rating, based on the wear rate of the tire when tested under controlled conditions on a specified government test course. For example, a tire graded 150 would wear one and one-half times as well on the government course as a tire graded 100. The relative performance of tires depends upon the actual conditions of their use, however, and may depart significantly from the norm due to variations in driving habits, service practices, and differences in road characteristics and climate.

Traction Grades

The Traction grades, from highest to lowest, are AA, A, B, and C. These grades represent the tire's ability to stop on wet pavement, as measured under controlled conditions on specified government test surfaces of asphalt and concrete. A tire marked C may have poor traction performance.

WARNING!

The traction grade assigned to this tire is based on straight-ahead braking traction tests, and does not include acceleration, cornering, hydroplaning, or peak traction characteristics.

Temperature Grades

The temperature grades are A (the highest), B, and C, representing the tire's resistance to the generation of heat and its ability to dissipate heat, when tested under controlled conditions on a specified indoor laboratory test wheel. Sustained high temperature can cause the material of the tire to degenerate and reduce tire life, and excessive temperature can lead to sudden tire failure. The grade C corresponds to a level of performance, which all passenger vehicle tires must meet under the Federal Motor Vehicle Safety Standard No. 109. Grades B and A represent higher levels of performance on the laboratory test wheel, than the minimum required by law.

WARNING!

The temperature grade for this tire is established for a tire that is properly inflated and not overloaded. Excessive speed, under-inflation, or excessive loading, either separately or in combination, can cause heat buildup and possible tire failure.

MAINTAINING YOUR VEHICLE

REPLACEMENT BULBS

Interior Bulbs

	Bulb Number
Message Center Indicators	Serviced at Authorized Dealer
Cluster	LED (Serviced at Authorized Dealer)
Gauge Pack	Serviced at Authorized Dealer
Heater Control	Serviced at Authorized Dealer
Interior Lamp	LED (Serviced at Authorized Dealer)
Courtesy Foot Well Lights	W3W
Cargo Lamp (Coupe Liftgate)	LED (Serviced at Authorized Dealer)

Exterior Bulbs

	Bulb Number
Low/High Beam Headlamp	HID (Serviced at Authorized Dealer)
Front Park/Turn Signal Lamp	LED (Serviced at Authorized Dealer)
Daytime Running Lamp (DRL)	LED (Serviced at Authorized Dealer)
Front Side Marker Lamp	2821M
Center High Mounted Stop Lamp (CHMSL)	LED (Serviced at Authorized Dealer)
Tail/Stop/Turn Signal Lamp	LED (Serviced at Authorized Dealer)
Rear Marker Lamp	2821M
Backup Lamp	LED (Serviced at Authorized Dealer)
License Lamp	LED (Serviced at Authorized Dealer)

FCA US LLC CUSTOMER CENTER

P.O. Box 21-8004 Auburn Hills, MI 48321-8004 Phone: 1-855-SRT-TEAM

FCA CANADA INC. CUSTOMER CENTER

P.O. Box 1621 Windsor, Ontario N9A 4H6 Phone: 1-800-465-2001 (English) Phone: 1-800-387-9983 (French)

ASSISTANCE FOR THE HEARING IMPAIRED

To assist customers who have hearing difficulties, the manufacturer has installed special TDD (Telecommunication Devices for the Deaf) equipment at its customer center. Any hearing or speech impaired customer, who has access to a TDD or a conventional teletypewriter (TTY) in the United States, can communicate with the manufacturer by dialing 1-800-380-CHRY. Canadian residents with hearing difficulties that require assistance can use the special needs relay service offered by Bell Canada. For TTY teletypewriter users, dial 711 and for Voice callers, dial 1-800-855-0511 to connect with a Bell Relay Service operator.

WARNING!

Engine exhaust, some of its constituents, and certain vehicle components contain, or emit, chemicals known to the State of California to cause cancer and birth defects, or other reproductive harm. In addition, certain fluids contained in vehicles and certain products of component wear contain, or emit, chemicals known to the State of California to cause cancer and birth defects, or other reproductive harm.

PUBLICATIONS ORDERING

- If you are the first registered retail owner of your vehicle, you may obtain a complimentary printed copy of the Owner's Manual, Navigation/Uconnect Manuals or Warranty Booklet. United States customers may visit the Dodge Contact Us page at www.dodge.com scroll to the bottom of the page and select the "Contact Us" link, then select the "Owner's Manual and Glove Compartment Material" from the left menu. You may also obtain a complimentary copy by calling 1-800-423-6343 (U.S.) or 1-800-387-1143 (Canada).
- Replacement User Guide kits or DVDs or, if you prefer, additional printed copies of the Owner's Manual, Warranty Booklet or Radio Manuals may be purchased by visiting www.techauthority.com or by calling 1-800-890-4038 (U.S.) or 1-800-387-1143 (Canada). Visa, Master Card, American Express and Discover orders are accepted. If you prefer mailing your order, please call the above numbers for an order form.

NOTE:

- A street address is required when ordering manuals (no P.O. Boxes).



CONSUMER ASSISTANCE

- The Owner's Manual and User Guide electronic files are also available on the Chrysler, Jeep®, Ram Truck, Dodge and SRT websites.
- Click on the "For Owners" tab, select "Owner/Service Manuals", then select your desired model year and vehicle from the drop down lists.

REPORTING SAFETY DEFECTS IN THE UNITED STATES

If you believe that your vehicle has a defect that could cause a crash or cause injury or death, you should immediately inform the National Highway Traffic Safety Administration (NHTSA) in addition to notifying FCA US LLC.

If NHTSA receives similar complaints, it may open an investigation, and if it finds that a safety defect exists in a group of vehicles, it may order a recall and remedy campaign. However, NHTSA cannot become involved in individual problems between you, your authorized dealer or FCA US LLC.

To contact NHTSA, you may call the Vehicle Safety Hotline toll free at 1-888-327-4236 (TTY: 1-800-424-9153); or go to <http://www.safercar.gov>; or write to: Administrator, NHTSA, 1200 New Jersey Avenue, SE., West Building, Washington, D.C. 20590. You can also obtain other information about motor vehicle safety from <http://www.safercar.gov>.

In Canada

If you believe that your vehicle has a safety defect, you should contact the Customer Service Department immediately. Canadian customers who wish to report a safety defect to the Canadian government should contact Transport Canada, Motor Vehicle Defect Investigations and Recalls at 1-800-333-0510 or go to <http://www.tc.gc.ca/roadsafety/>.

French Canadian customers who wish to report a safety defect to the Canadian government should contact Transport Canada, Motor Vehicle Defect Investigations and Recalls at 1-800-333-0510 or go to <http://www.tc.gc.ca/securiteroutiere/>.

AUTHENTIC ACCESSORIES BY MOPAR

- The following highlights just some of the many Authentic Viper Accessories by Mopar featuring a fit, finish, and functionality specifically for your Viper.
- In choosing Authentic Accessories you gain far more than expressive style, premium protection, or extreme entertainment, you also benefit from enhancing your vehicle with accessories that have been thoroughly tested and factory-approved.
- For the full line of Authentic Viper Accessories by Mopar, visit your local dealership or online at mopar.com for U.S. residents and mopar.ca for Canadian residents.

NOTE:

All parts are subject to availability.

PERFORMANCE:

- Brake Rotors

- Carbon Fiber X-Brace

EXTERIOR:

- Custom Wheels
- Vehicle Dust Covers

- Wheel Locks

INTERIOR:

- Premium Carpet Floor Mats
- Door Sill Guards
- Pedal Kits

- Premium Carpet Cargo Mat
- Cargo Security Cover
- Unique Katzkin Leather Interiors

ELECTRONICS:

- Battery Charger
- Electronic Vehicle Tracking System

- Wireless Charging Pad

FREQUENTLY ASKED QUESTIONS

FREQUENTLY ASKED QUESTIONS

GETTING STARTED

- How do I adjust my foot rest? pg. 49
- How do I adjust my pedals? pg. 48

OPERATING YOUR VEHICLE

- How does my speed control work? pg. 53

ELECTRONICS

Which radio is in my vehicle?

- Uconnect 8.4 NAV pg. 79

How do I activate the Audio Jack?

- Uconnect 8.4 NAV pg. 86

How do I set the clock on my radio?

- Uconnect 8.4 NAV pg. 79
- How do I pair my cell phone via Bluetooth with the Uconnect Hands-Free Voice Activation System? pg. 112
- How do I use my USB port to listen to audio through my touch-screen radio? pg. 86
- How do I configure my Universal Garage Door Opener (HomeLink)? pg. 125

UTILITY

- How do I know how much I can tow with my Viper? pg. 129

WHAT TO DO IN EMERGENCIES

- What do I do if my TPMS warning light is blinking? pg. 131
- How do I Jump-Start my vehicle? pg. 142

MAINTAINING YOUR VEHICLE

- Where is my Fuse Block located? pg. 158
- What type of oil do I use? pg. 150
- How often should I change my engine's oil? pg. 154
- What should my tire pressure be set at? pg. 164

- Access
 - Uconnect 67
- Accessories 175
 - Mopar 175
- Adding Engine Coolant (Antifreeze) . . . 153
- Adding Fuel 152
- Adding Washer Fluid 153
- Additives, Fuel 153
- Adjust
 - Forward 46
 - Rearward 46
- Adjustable Pedals 48
- Aftermarket 3
- Air Bag 23
 - Advance Front Air Bag 23
 - Air Bag Operation 25
 - Air Bag Warning Light 22, 25
 - Enhanced Accident Response 35, 145
 - Event Data Recorder (EDR) 146
 - Front Air Bag 23, 25
 - If A Deployment Occurs 35
 - Knee Impact Bolsters 32
 - Maintaining Your Air Bag System 36
- Air Bag Light 22, 131
- Air Bag Maintenance 36
- Air Cleaner, Engine (Engine Air Cleaner Filter) 153
- Air Conditioner Maintenance 153
- Air Conditioning 60, 62
- Air Conditioning Refrigerant 153
- Air Conditioning System 153
- Alarm
 - Vehicle Security Alarm 10
- Alarm (Security Alarm) 10, 135
- Antifreeze (Engine Coolant) . . . 150, 153
 - Capacities 150
 - Disposal 153
- Anti-Lock Warning Light 131
- APP
 - Uconnect Access 70
- Appearance Care 153
- Arming System (Security Alarm) . . . 10
- Assistance Towing 130
- Automatic Headlights 52
- Automatic High Beams 52
- Automatic Temperature Control (ATC) 60
- Battery 153
 - Emergency Starting 142
 - Jump Starting 142
- Body Mechanism Lubrication 153
- B-Pillar Location 164
- Brakes 153
- Brake System 153
 - Fluid Check 151
 - Master Cylinder 153
 - Warning Light 133
- Bulbs, Light 172
- Calibration, Compass 121
- Camera, Rear 62
- Canada 3, 174
- Capacities, Antifreeze (Engine Coolant) 150
- Capacities, Fluid 150
- Caps, Filler
 - Oil (Engine) 153
- Car Washes 153
- Charging System Light 130
- Chart, Tire Sizing 161
- Child Restraint 37
- Child Restraints
 - Booster Seats 40
 - Child Restraints 37
 - Child Seat Installation 42
 - Infants And Child Restraints 38
 - Older Children And Child Restraints 39
 - Using The Top Tether Anchorage . . 43
- Cleaning
 - Wheels 153, 169
 - Windshield Wiper Blades 153
- Climate Control 60
- Cluster Warning/Indicator Lights
 - Anti-Lock Brake (ABS) Light . . . 131
 - Brake Warning Light 133
 - Charging System Light 130
 - Electronic Speed Control SET Indicator 135
 - Engine Temperature Warning Light 133
 - High Beam Indicator 135

- Oil Pressure Warning Light131
- Tire Pressure Monitoring System (TPMS) Light131
- Turn Signal Indicator135
- Vehicle Security Light135
- Clutch153
- Clutch Fluid153
- Compact Spare Tire168
- Compass Calibration121
- Cooling System.153
 - Adding Coolant (Antifreeze)153
 - Coolant Capacity150
 - Coolant Level153
 - Disposal Of Used Coolant153
 - Drain, Flush, And Refill153
 - Inspection153
 - Points To Remember153
 - Pressure Cap153
 - Selection Of Coolant (Antifreeze)150, 153
- Corrosion Protection153
- Customer Assistance.173, 174
- Customer Programmable Features124
- Defects, Reporting174
- Dimmer Control52
- Dimmer Switch, Headlight52
- Disabled Vehicle Towing130
- Disposal
 - Antifreeze (Engine Coolant)153
- Disturb116
- Door Locks11
- Doors11
- Electronics.3
 - Your Vehicle's Sound System64
- Electronic Speed Control (Cruise Control)53
- Electronic Stability Control (ESC)58, 134
- Electronic Stability Control (ESC) OFF Indicator.135
- Emergencies, What To Do In130
- Emergency130
- Emergency, In Case Of
 - Freeing Vehicle When Stuck145
 - Jump Starting142
 - Overheating136
- Towing130
- Emergency Key9
- Engine
 - Air Cleaner153
 - Checking Oil Level153
 - Coolant (Antifreeze)150
 - Cooling153
 - Fuel Requirements150
 - Oil150, 153
 - Oil Filler Cap153
 - Oil Selection150, 153
 - Overheating136
 - Starting9
 - Stopping9
 - Temperature Warning Light133
- Engine Oil Viscosity150
- Enhanced Accident Response
 - Feature35, 145
- Exhaust System153
- FAQ176
- Filters
 - Air Cleaner153
 - Engine Oil150, 153
 - Engine Oil Disposal153
- Flashers
 - Turn Signal135
- Fluid Capacities150
- Fluid Level Checks
 - Brake151
 - Capacities150
 - Manual Transmission151
 - Power Steering151
- Fluids, Lubricants And Genuine Parts.150
- Fog Lights52
- Freeing A Stuck Vehicle145
- Frequently Asked Questions176
- Fuel
 - Adding152
 - Additives153
 - Materials Added153
 - Octane Rating150
 - Requirements150
 - Tank Capacity150
- Fuse158
- Fuses158

Garage Door Opener (HomeLink) . . .	125	Latches	
General Maintenance	153	Hood	147
Glass Cleaning	153	Lights	
Hands-Free Phone (Uconnect) . . .	111	Air Bag	22
Headlamp	52	Bulb Replacement	172
Headlights		High Beam Indicator	135
Automatic	52	Low Fuel	130
Cleaning	153	Seat Belt Reminder	133
Dimmer Switch	52	Security Alarm	135
High Beam	51	Service	172
Head Restraints	45	Tire Pressure Monitoring	
High Beam Indicator	135	(TPMS)	131
High Beam/Low Beam Select		Loading Vehicle	
(Dimmer) Switch	51	Tires	164
HomeLink (Garage Door Opener) . .	125	Locks	11
Hood Release	147	Door	11
Instrument Cluster	6	Power Door	12
Instrument Cluster Warning		Lubrication, Body	153
Lights	130, 135	Maintaining Your Vehicle	147
Instrument Panel Cover	153	Maintenance	147
Instrument Panel Lens Cleaning . .	153	Maintenance Free Battery	153
Interior And Instrument Lights . . .	5	Maintenance, General	147, 153
Interior Appearance Care	153	Maintenance Procedures	153
Intermittent Wipers (Delay Wipers) .	51	Maintenance Record	157
Introduction	2	Maintenance Schedule	153, 155
Aftermarket Electronics	3	Malfunction Indicator Light	
Canada	3	(Check Engine)	134
In Vehicle Features		Manual Transmission	
Uconnect Access	73	Fluid Level Check	151
iPod/USB/MP3 Control		Lubricant Selection	151
Bluetooth Streaming Audio . . .	111	Master Cylinder (Brakes)	153
Jump Starting	142	Mopar	175
Key Fob	8	MOPAR Accessories	175
Locking Doors	8	Navigation	88
Locking Liftgate	8	Occupant Restraints	13
Unlocking Doors	8	Oil, Engine	150, 153
Unlocking Liftgate	8	Capacity	150
Key Fob Programmable Features . .	122	Change Interval	153
Keyless Enter-N-Go		Checking	153
Starting/Stopping	9	Disposal	153
Keyless Entry System	8	Filter	150, 153
Lap/Shoulder Belts	16	Filter Disposal	153
		Materials Added To	153
		Recommendation	150, 153
		Viscosity	150, 153

INDEX

- Oil Filter, Selection 153
- Oil Pressure Light 131
- Outlet
 - Power 128
- Overheating, Engine 136

- Paint Care 153
- Panic Alarm 8
- Pedals, Adjustable 48
- Phone, Hands-Free (Uconnect) . . . 111
- Phone (Pairing) 93
- Phone (Uconnect) 111
- Placard, Tire And Loading
 - Information 164, 165
- Power
 - Door Locks 12
 - Outlet (Auxiliary Electrical Outlet) 128
 - Windows 13
- Power Seats
 - Forward 46
 - Rearward 46
- Pregnant Women And Seat Belts . . . 19
- Pretensioners
 - Seat Belts 19
- Programmable Electronic
 - Features 123, 124
- Purchase Apps
 - Uconnect Access 71

- Radio
 - Bluetooth Hands Free Calling . . . 119
 - Presets 82
- Rain Sensitive Wiper System 51
- Rear Camera 62
- Reclining Front Seats 47
- Recreational Towing 129
- Refrigerant 153
- Reminder, Seat Belt 15
- Reporting Safety Defects 174
- Restraint, Head 45
- Restraints, Child 37
- Rocking Vehicle When Stuck 145

- Safety Information, Tire 161
- Schedule, Maintenance 153

- Seat Belt
 - Automatic Locking Retractor (ALR) 20
 - Energy Management Feature 19
 - Lap/Shoulder Belt Operation 17
 - Lap/Shoulder Belts 16
 - Lap/Shoulder Belt Untwisting 18
 - Pregnant Women 19
 - Seat Belt Extender 18
 - Seat Belt Pretensioner 19
 - Seat Belt Reminder 15
- Seat Belt Maintenance 153
- Seat Belt Reminder 15
- Seat Belts 15
 - Child Restraint 37
 - Extender 18
 - Front Seat 15, 16, 17
 - Operating Instructions 17
 - Pregnant Women 19
 - Pretensioners 19
 - Rear Seat 16
 - Reminder 133
 - Untwisting Procedure 18
- Seats 46
 - Adjustment 46, 47
 - Reclining 47
- Security Alarm 135
 - Security Alarm 10
- Selection Of Coolant (Antifreeze) . . . 150
- Shoulder Belts 16
- Signals, Turn 135
- Siri 98, 99
- SIRIUS Travel Link 91
- Spare Tire 168, 169
- Spark Plugs 150
- Speed Control
 - Resume 54
- Speed Control (Cruise Control) 53
- Starting
 - Emergency (Jump Starting) 142
- Steering
 - Tilt Column 49
- Stuck, Freeing 145
- Supplemental Restraint System - Air Bag 23

- Temperature Control, Automatic (ATC) 60

- Text Messaging117, 118
- Tilt Steering Column49
- Tire And Loading Information
 - Placard164, 165
- Tire Markings161
- Tires167, 168, 171
 - Air Pressure164
 - Compact Spare168
 - General Information167, 168
 - Load Capacity164, 165
 - Quality Grading171
 - Safety161
 - Sizes161
 - Spare Tire168, 169
- Tire Safety Information161
- Tire Safety Kit136, 137
- Towing129
 - Disabled Vehicle144
 - Recreational129
- Towing Vehicle Behind A
 - Motorhome129
- Trailer Towing
 - Trailer And Tongue Weight . . .129
- Trailer Weight129
- Transmission
 - Fluid151, 153
 - Maintenance153
- Turn Signals135
- Uconnect
 - Access67
 - Using Access71
 - Via Mobile Apps70
- Uconnect 8.4/8.4 NAV79
- Uconnect Access
 - APP70
 - In Vehicle Features73
 - Purchase Apps71
- Uconnect (Hands-Free Phone)
 - Making A Phone Call111
 - Receiving A Call111
- Uconnect Phone93, 111, 117
 - Phonebook Download115
 - Transfer Call To And From Mobile
 - Phone115
 - Voice Command116
- Uconnect Voice Command92
- Uniform Tire Quality Grades171
- Untwisting Procedure, Seat Belt . . .18
- Using Access
 - Uconnect71
- Vehicle Loading165
- Via Mobile Apps
 - Uconnect70
- Viscosity, Engine Oil150
- Voice Command92
- Voice Recognition System (VR) . .92, 116
- Washer
 - Adding Fluid153
- Washers, Windshield51
- Washing Vehicle153
- Wheel And Wheel Trim153, 169
- Wheel And Wheel Trim Care . . .153, 169
- Windows13
 - Power13
- Windshield Washers51
- Windshield Wiper Blades153
- Windshield Wipers51
- Wiper Blade Replacement153



NOTES

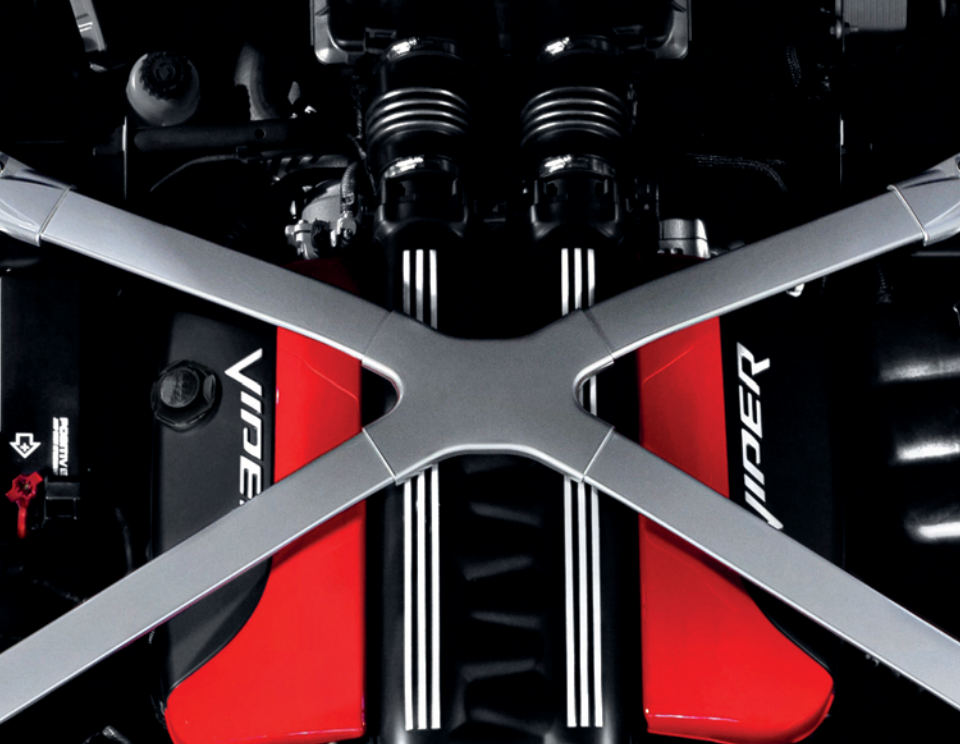

DRIVESRT.COM (U.S.) DRIVESRT.CA (CANADA)

This guide has been prepared to help you get quickly acquainted with your new SRT and to provide a convenient reference source for common questions. However, it is not a substitute for your Owner's Manual.

For complete operational instructions, maintenance procedures and important safety messages, please consult your Owner's Manual, Navigation/Uconnect Manuals, and other Warning Labels in your vehicle.

Not all features shown in this guide may apply to your vehicle. For additional information on accessories to help personalize your vehicle, visit www.mopar.com (U.S.), www.mopar.ca (Canada) or your local SRT high performance dealer.

DRIVING AND ALCOHOL

Drunken driving is one of the most frequent causes of accidents. Your driving ability can be seriously impaired with blood alcohol levels far below the legal minimum. If you are drinking, don't drive. Ride with a designated non-drinking driver, call a cab, a friend, or use public transportation.

WARNING!

Driving after drinking can lead to an accident. Your perceptions are less sharp, your reflexes are slower, and your judgment is impaired when you have been drinking. Never drink and then drive.



Whether it's providing information about specific product features, taking a tour through your vehicle's heritage, knowing what steps to take following an accident, or scheduling your next appointment, we know you'll find the app an important extension of your RAM vehicle. Simply download the app, select your make and model and enjoy the ride. To get this app, go directly to the App Store or Google Play and enter the search keyword "RAM TOOLBOX" (U.S. market only).

RAMTRUCKS.com/EN/Owners provides special offers tailored to your needs, customized vehicle galleries, personalized service records and more. To get this information, just create an account and check back often.



DOWNLOAD A FREE ELECTRONIC COPY OF THE OWNER'S MANUAL AND WARRANTY BOOKLET BY VISITING:

www.MOPAROWNERCONNECT.COM/OC/US/EN-US (U.S.)

www.OWNERS.MOPAR.CA/EN (CANADA)

© 2016 FCA US LLC. All Rights Reserved.
Dodge is a registered trademark of FCA US LLC.



17ZD-926-AA
Viper

First Edition
User Guide