

**Jeep**<sup>®</sup>

# 2022 WRANGLER

OWNER'S MANUAL



This Owner's Manual illustrates and describes the operation of features and equipment that are either standard or optional on this vehicle. This manual may also include a description of features and equipment that are no longer available or were not ordered on this vehicle. Please disregard any features and equipment described in this manual that are not on this vehicle. FCA US LLC reserves the right to make changes in design and specifications, and/or make additions to or improvements to its products without imposing any obligation upon itself to install them on products previously manufactured.

With respect to any vehicles sold in Canada, the name FCA US LLC shall be deemed to be deleted and the name FCA Canada Inc. used in substitution therefore.

This Owner's Manual is intended to familiarize you with the important features of your vehicle. Your most up-to-date Owner's Manual, Navigation/Uconnect manuals and Warranty Booklet can be found by visiting the website on the back cover.

**U.S. Residents:** If you are the first registered retail owner of your vehicle, you may obtain a complimentary printed copy of the Warranty Booklet by calling **1-877-426-5337** or by contacting your dealer. Replacement kits can be purchased by visiting **[www.techauthority.com](http://www.techauthority.com)**.

**Canadian Residents:** If you are the first registered retail owner of your vehicle, you may obtain a complimentary printed copy of the Warranty Booklet or purchase a replacement kit by calling **1-800-387-1143** or by contacting your dealer.

 **WARNING:** Operating, servicing and maintaining a passenger vehicle or off-highway motor vehicle can expose you to chemicals including engine exhaust, carbon monoxide, phthalates, and lead, which are known to the State of California to cause cancer and birth defects or other reproductive harm. To minimize exposure, avoid breathing exhaust, do not idle the engine except as necessary, service your vehicle in a well-ventilated area and wear gloves or wash your hands frequently when servicing your vehicle. For more information go to **[www.P65Warnings.ca.gov/passenger-vehicle](http://www.P65Warnings.ca.gov/passenger-vehicle)**.

# TABLE OF CONTENTS

1	INTRODUCTION.....	9
2	GETTING TO KNOW YOUR VEHICLE .....	16
3	GETTING TO KNOW YOUR INSTRUMENT PANEL .....	116
4	STARTING AND OPERATING .....	139
5	MULTIMEDIA .....	207
6	SAFETY .....	275
7	IN CASE OF EMERGENCY .....	330
8	SERVICING AND MAINTENANCE .....	347
9	TECHNICAL SPECIFICATIONS .....	417
10	CUSTOMER ASSISTANCE .....	428
11	INDEX.....	432

1

2

3

4

5

6

7

8

9

10



11

## INTRODUCTION





<b>SYMBOLS KEY</b> .....	<b>10</b>
<b>ROLLOVER WARNING</b> .....	<b>10</b>
<b>VEHICLE MODIFICATIONS/ALTERATIONS</b> .....	<b>11</b>
<b>SYMBOL GLOSSARY</b> .....	<b>11</b>

## GETTING TO KNOW YOUR VEHICLE

<b>KEYS</b> .....	<b>16</b>
Key Fob .....	16
<b>SENTRY KEY</b> .....	<b>18</b>
<b>IGNITION SWITCH</b> .....	<b>19</b>
Keyless Enter 'n Go™ Ignition .....	19
<b>REMOTE START — IF EQUIPPED (GASOLINE)</b> ....	<b>21</b>
How To Use Remote Start.....	21
To Exit Remote Start Mode.....	22
Remote Start Front Defrost Activation — If Equipped.....	22
Remote Start Comfort Systems — If Equipped .....	22
Remote Start Windshield Wiper De-Icer Activation — If Equipped .....	23
Remote Start Cancel Message.....	23
<b>REMOTE START — IF EQUIPPED (DIESEL)</b> .....	<b>23</b>
How To Use Remote Start.....	23
<b>VEHICLE SECURITY SYSTEM — IF EQUIPPED</b> ....	<b>24</b>
To Arm The System .....	24
To Disarm The System .....	24
Rearming Of The System .....	25

<b>DOORS</b> .....	<b>25</b>
Manual Door Locks .....	25
Power Door Locks — If Equipped .....	26
Keyless Enter 'n Go™ — Passive Entry (If Equipped) .....	26
Automatic Door Locks — If Equipped.....	28
Child-Protection Door Lock System — Rear Doors.....	28
Front Door Removal.....	29
Rear Door Removal (Four-Door Models) .....	32
Door Off Mirror Kit — If Equipped  .....	34
Half-Door Installation — If Equipped  .....	36
<b>STEERING WHEEL</b> .....	<b>42</b>
Tilt/Telescoping Steering Column .....	42
Heated Steering Wheel — If Equipped .....	42
<b>SEATS</b> .....	<b>43</b>
Manual Adjustment Front Seats .....	43
60/40 Split Folding Rear Seat — Four Door Models .....	45
Fold And Tumble Rear Seat — Two Door Models .....	45
Heated Seats — If Equipped .....	47
Rear Seat Armrest — If Equipped .....	47
Head Restraints .....	48

<b>UNCONNECT VOICE RECOGNITION</b> .....	<b>50</b>
Introducing Voice Recognition .....	50
Basic Voice Commands .....	50
Get Started .....	51
Additional Information .....	51
<b>MIRRORS</b> .....	<b>51</b>
Inside Rearview Mirror.....	51
Illuminated Vanity Mirrors .....	52
Outside Mirrors .....	52
Heated Mirrors — If Equipped .....	53
Power Mirrors — If Equipped .....	53
<b>UNIVERSAL GARAGE DOOR OPENER (HOMELINK®) — IF EQUIPPED </b> .....	<b>53</b>
Before You Begin Programming HomeLink® .....	53
Erasing All The HomeLink® Channels.....	54
Identifying Whether You Have A Rolling Code Or Non-Rolling Code Device.....	54
Programming HomeLink® To A Garage Door Opener .....	54
Programming HomeLink® To A Miscellaneous Device.....	55
Reprogramming A Single HomeLink® Button .....	55
Canadian/Gate Operator Programming .....	55
Security .....	56
Troubleshooting Tips.....	56

<b>EXTERIOR LIGHTS</b> .....	57	<b>INTERIOR STORAGE AND EQUIPMENT</b> .....	69	<b>FOLDING WINDSHIELD</b> .....	109
Headlight Switch.....	57	Storage.....	69	Lowering The Windshield.....	110
Daytime Running Lights (DRLs) –		USB/AUX Control .....	69	Raising The Windshield .....	112
If Equipped .....	58	Power Outlets .....	71	<b>HOOD</b> .....	<b>112</b>
High/Low Beam Switch.....	58	Power Inverter – If Equipped .....	72	Opening The Hood .....	112
Automatic High Beam Headlamp Control –		Auxiliary Switches – If Equipped .....	73	Closing The Hood .....	113
If Equipped .....	58	<b>POWER WINDOWS – IF EQUIPPED</b> .....	<b>75</b>	<b>REAR SWING GATE</b> .....	<b>113</b>
Flash-To-Pass.....	58	Auto-Down Feature .....	75	Cargo Area Features .....	114
Automatic Headlights – If Equipped .....	58	Window Lockout Switch.....	76	<b>ROOF LUGGAGE RACK – IF EQUIPPED</b> .....	<b>114</b>
Lights-On Reminder.....	59	Wind Buffeting .....	76		
Front Fog Lights – If Equipped .....	59	<b>WRANGLER TOPS</b> .....	<b>76</b>		
Turn Signals.....	59	Provided Tools.....	76		
Lane Change Assist – If Equipped .....	59	Lowering The Soft Top Into Sunrider®			
<b>INTERIOR LIGHTS</b> .....	<b>59</b>	Position 	76	<b>GETTING TO KNOW YOUR</b>	
Interior Courtesy Lights.....	59	Raising The Soft Top 	87	<b>INSTRUMENT PANEL</b>	
Dimmer Controls .....	60	Removing The Soft Top 	90	<b>INSTRUMENT CLUSTER</b> .....	<b>116</b>
<b>WINDSHIELD WIPERS AND WASHERS</b> .....	<b>60</b>	Installing The Soft Top .....	91	Instrument Cluster Descriptions.....	120
Windshield Wiper Operation .....	60	Hard Top Front Panel(s) Removal 	93	<b>INSTRUMENT CLUSTER DISPLAY</b> .....	<b>120</b>
Rear Window Wiper/Washer – If Equipped ...	61	Hard Top Front Panel(s) Installation .....	97	Instrument Cluster Display Location And	
<b>CLIMATE CONTROLS</b> .....	<b>62</b>	Removing The Hard Top .....	97	Controls.....	121
Automatic Climate Control Descriptions And		Installing The Hard Top.....	99	Oil Change Reset – If Equipped.....	121
Functions .....	62	Sunrider® For Hard Top .....	99	Instrument Cluster Display Selectable	
Manual Climate Control Descriptions And		Power Sliding Top – If Equipped .....	102	Items .....	122
Functions .....	65	<b>DOOR FRAME</b> .....	<b>106</b>	Battery Saver On/Battery Saver Mode	
Automatic Temperature Control (ATC) –		Door Frame Removal.....	107	Message – Electrical Load Reduction	
If Equipped.....	67	Door Frame Installation Four Door		Actions – If Equipped .....	125
Climate Voice Commands .....	67	Models – If Equipped.....	107	Diesel Displays .....	126
Operating Tips .....	68	Door Frame Installation Two Door		Diesel Particulate Filter (DPF) Messages ...	127
		Models – If Equipped.....	109	Fuel System Messages.....	128

<b>WARNING LIGHTS AND MESSAGES .....</b>	<b>128</b>	<b>STARTING THE ENGINE — DIESEL ENGINE</b>	<b>FOUR-WHEEL DRIVE OPERATION .....</b>	<b>157</b>
Red Warning Lights .....	128	<b>(IF EQUIPPED).....</b>	Four-Position Transfer Case —	
Yellow Warning Lights .....	131	Automatic Transmission .....	If Equipped .....	157
Yellow Indicator Lights .....	134	Extreme Cold Weather .....	Five-Position Transfer Case — If Equipped ..	159
Green Indicator Lights.....	135	Normal Starting.....	Trac-Lok Rear Axle — If Equipped .....	161
White Indicator Lights .....	136	Starting Fluids .....	Axle Lock (Tru-Lok) Front And Rear —	
Blue Indicator Lights .....	137	<b>NORMAL OPERATION — DIESEL ENGINE.....</b>	If Equipped .....	161
Gray Indicator Lights .....	137	Cold Weather Precautions.....	Axle Lock (Tru-Lok) Rear Only —	
<b>ONBOARD DIAGNOSTIC SYSTEM — OBD II .....</b>	<b>137</b>	Engine Idling.....	If Equipped .....	162
Onboard Diagnostic System (OBD II)		Stopping The Engine .....	Electronic Sway Bar Disconnect —	
Cybersecurity .....	137	Cooling System Tips — Automatic	If Equipped .....	162
<b>EMISSIONS INSPECTION AND MAINTENANCE</b>		Transmission .....	Off Road+ — If Equipped.....	163
<b>PROGRAMS .....</b>	<b>138</b>	<b>ENGINE BREAK-IN RECOMMENDATIONS —</b>	<b>ELECTRO-HYDRAULIC POWER STEERING .....</b>	<b>164</b>
		<b>GASOLINE ENGINE (IF EQUIPPED) .....</b>	<b>STOP/START SYSTEM — AUTOMATIC</b>	
		<b>ENGINE BREAK-IN RECOMMENDATIONS —</b>	<b>TRANSMISSION (IF EQUIPPED) .....</b>	<b>165</b>
<b>STARTING AND OPERATING</b>		<b>DIESEL ENGINE (IF EQUIPPED) .....</b>	Autostop Mode.....	165
<b>STARTING THE ENGINE — GASOLINE ENGINE</b>		<b>PARKING BRAKE.....</b>	Possible Reasons The Engine Does Not	
<b>(IF EQUIPPED) .....</b>	<b>139</b>	<b>MANUAL TRANSMISSION — IF EQUIPPED .....</b>	Autostop.....	166
Manual Transmission — If Equipped .....	139	Shifting.....	To Start The Engine While In Autostop	
Automatic Transmission — If Equipped .....	139	Downshifting.....	Mode .....	166
Normal Starting .....	139	<b>AUTOMATIC TRANSMISSION —</b>	To Manually Turn Off The Stop/Start	
AutoPark .....	140	<b>IF EQUIPPED .....</b>	System .....	167
Extreme Cold Weather (Below -22° F Or		Ignition Park Interlock.....	To Manually Turn On The Stop/Start	
-30 °C) .....	141	Brake/Transmission Shift Interlock (BTSI)	System .....	167
Extended Park Starting.....	141	System .....	System Malfunction .....	167
If Engine Fails To Start.....	142	8-Speed Automatic Transmission .....		
After Starting.....	142			

**STOP/START SYSTEM — MANUAL**

<b>TRANSMISSION (IF EQUIPPED)</b> .....	<b>167</b>
Autostop Mode .....	168
Possible Reasons The Engine Does Not Autostop .....	168
To Start The Engine While In Autostop Mode .....	168
To Manually Turn Off The Stop/Start System .....	169
To Manually Turn On The Stop/Start System .....	169
System Malfunction .....	169

**CRUISE CONTROL SYSTEMS —**

<b>IF EQUIPPED</b> .....	<b>169</b>
Cruise Control .....	169
Adaptive Cruise Control (ACC) .....	171

**PARKSENSE REAR PARK ASSIST —**

<b>IF EQUIPPED</b> .....	<b>180</b>
ParkSense Sensors .....	180
ParkSense Warning Display .....	180
ParkSense Display .....	180
Enabling And Disabling ParkSense .....	182
Service The ParkSense Rear Park Assist System .....	182
Cleaning The ParkSense System .....	183
ParkSense System Usage Precautions .....	183

**PARKVIEW REAR BACK UP CAMERA .....****TRAILCAM SYSTEM — IF EQUIPPED .....****REFUELING THE VEHICLE — GASOLINE**

<b>ENGINE (IF EQUIPPED)</b> .....	<b>186</b>
Fuel Filler Cap .....	186
Loose Fuel Filler Cap Message .....	187

**REFUELING THE VEHICLE — DIESEL**

<b>ENGINE (IF EQUIPPED)</b> .....	<b>187</b>
Avoid Using Contaminated Fuel .....	188
Bulk Fuel Storage — Diesel Fuel .....	188
Diesel Exhaust Fluid .....	188

**VEHICLE LOADING .....**

Certification Label .....	191
---------------------------	-----

**TRAILER TOWING .....**

Common Towing Definitions .....	192
Trailer Hitch Classification .....	193
Trailer Towing Weights (Maximum Trailer Weight Ratings) .....	194
Trailer And Tongue Weight .....	194
Towing Requirements .....	195
Towing Tips .....	197

**RECREATIONAL TOWING (BEHIND****MOTORHOME) .....**

Towing This Vehicle Behind Another Vehicle .....	198
Recreational Towing — Four-Wheel Drive Models .....	198

**DRIVING TIPS .....**

On-Road Driving Tips .....	200
Off-Road Driving Tips .....	200

**MULTIMEDIA****UNCONNECT SYSTEMS .....****CYBERSECURITY .....****UNCONNECT SETTINGS .....**

Customer Programmable Features .....	208
--------------------------------------	-----



**UNCONNECT INTRODUCTION .....**

System Overview .....	222
Drag & Drop Menu Bar .....	225
Safety And General Information .....	225

**UNCONNECT MODES .....**

Steering Wheel Audio Controls .....	226
Radio Mode .....	227
Media Mode .....	236
Phone Mode .....	239

**ANDROID AUTO™ & APPLE CARPLAY® —****IF EQUIPPED .....**

Android Auto™  .....	250
Apple CarPlay®  .....	252
Android Auto™ And Apple CarPlay® Tips And Tricks .....	254

**CONNECTED VEHICLE SERVICES —****IF EQUIPPED .....**

Is My Vehicle Connected? .....	254
Introduction To Connected Vehicle Services .....	254
Getting Started With Connected Vehicle Services .....	256
Using SiriusXM Guardian™ .....	257
Manage My SiriusXM Guardian™ Account ..	267

<b>CONNECTED SERVICES FAQs .....</b>	<b>267</b>
Connected Services SOS FAQs – If Equipped .....	267
Connected Services Remote Door Lock/ Unlock FAQs .....	267
Connected Services Roadside Assistance FAQs .....	268
Connected Services Send & Go FAQs – If Equipped .....	268
Connected Services Vehicle Finder FAQs ...	268
Connected Services Stolen Vehicle Assistance FAQs – If Equipped .....	269
Connected Services Remote Vehicle Start FAQs .....	269
Connected Services Remote Horn & Lights FAQs .....	269
Connected Services Account FAQs – If Equipped.....	270
Data Collection & Privacy.....	271
<b>RADIO OPERATION AND MOBILE PHONES.....</b>	<b>272</b>
Regulatory And Safety Information .....	272
<b>OFF-ROAD PAGES — IF EQUIPPED .....</b>	<b>272</b>
Off-Road Pages Status Bar .....	273
Drivetrain .....	273
Accessory Gauge .....	274
Pitch & Roll .....	274
TrailCam — If Equipped .....	274

## SAFETY

<b>SAFETY FEATURES.....</b>	<b>275</b>
Anti-Lock Brake System (ABS) .....	275
Electronic Brake Control (EBC) System .....	276
<b>AUXILIARY DRIVING SYSTEMS.....</b>	<b>284</b>
Blind Spot Monitoring (BSM) – If Equipped .....	284
Forward Collision Warning (FCW) With Mitigation — If Equipped .....	288
Tire Pressure Monitoring System (TPMS)....	290
<b>OCCUPANT RESTRAINT SYSTEMS .....</b>	<b>295</b>
Occupant Restraint Systems Features .....	295
Important Safety Precautions .....	295
Seat Belt Systems .....	296
Supplemental Restraint Systems (SRS) .....	302
Child Restraints.....	314
<b>SAFETY TIPS .....</b>	<b>327</b>
Transporting Passengers.....	327
Transporting Pets.....	327
Connected Vehicles .....	327
Safety Checks You Should Make Inside The Vehicle .....	327
Periodic Safety Checks You Should Make Outside The Vehicle .....	329
Exhaust Gas.....	329
Carbon Monoxide Warnings .....	329

## IN CASE OF EMERGENCY

<b>HAZARD WARNING FLASHERS .....</b>	<b>330</b>
<b>ASSIST AND SOS SYSTEM — IF EQUIPPED .....</b>	<b>330</b>
<b>JACKING AND TIRE CHANGING .....</b>	<b>333</b>
Preparations For Jacking .....	333
Jack Location .....	334
Spare Tire Removal .....	335
Jacking Instructions .....	335
<b>JUMP STARTING .....</b>	<b>338</b>
Preparations For Jump Start .....	338
Jump Starting Procedure .....	340
<b>IF YOUR ENGINE OVERHEATS .....</b>	<b>341</b>
<b>MANUAL PARK RELEASE .....</b>	<b>341</b>
<b>FREEING A STUCK VEHICLE .....</b>	<b>343</b>
<b>TOWING A DISABLED VEHICLE.....</b>	<b>344</b>
Four Wheel Drive Models .....	345
Without The Key Fob.....	345
Emergency Tow Hooks — If Equipped .....	345
<b>ENHANCED ACCIDENT RESPONSE SYSTEM (EARS) .....</b>	<b>346</b>
<b>EVENT DATA RECORDER (EDR).....</b>	<b>346</b>

## SERVICING AND MAINTENANCE

<b>SCHEDULED SERVICING —</b>	
<b>GASOLINE ENGINE .....</b>	<b>347</b>
Maintenance Plan.....	348



<b>SCHEDULED SERVICING — DIESEL ENGINE</b> ....	<b>351</b>	Windshield Wiper Blades.....	368	<b>INTERIORS</b> .....	<b>411</b>
Maintenance Plan — Diesel Fuel Up To B5		Exhaust System .....	370	Carpet Safety Information .....	411
Biodiesel .....	352	Cooling System .....	371	Carpet Removal.....	411
Additional Maintenance — B6 To B20		Brake System .....	374	Seats And Fabric Parts .....	415
Biodiesel .....	354	Front/Rear Axle Fluid .....	375	Plastic And Coated Parts .....	416
<b>ENGINE COMPARTMENT</b> .....	<b>355</b>	Transfer Case .....	376	Leather Surfaces.....	416
2.0L Gasoline Engine .....	355	Manual Transmission — If Equipped.....	376	Glass Surfaces .....	416
3.6L Gasoline Engine .....	356	Automatic Transmission — If Equipped .....	376		
3.0L Diesel Engine .....	357	Fuses .....	377		
Checking Oil Level .....	358	Bulb Replacement.....	387	<b>TECHNICAL SPECIFICATIONS</b>	
Adding Washer Fluid .....	358	<b>TIRES</b> .....	<b>391</b>	<b>VEHICLE IDENTIFICATION NUMBER (VIN)</b> .....	<b>417</b>
Maintenance-Free Battery .....	358	Tire Safety Information .....	391	<b>BRAKE SYSTEM</b> .....	<b>417</b>
Pressure Washing .....	359	Tires — General Information .....	398	<b>WHEEL AND TIRE TORQUE SPECIFICATIONS</b> ..	<b>417</b>
<b>VEHICLE MAINTENANCE</b> .....	<b>359</b>	Tire Types.....	401	Torque Specifications .....	417
Engine Oil.....	360	Spare Tires — If Equipped .....	402	<b>FUEL REQUIREMENTS — GASOLINE ENGINE</b> ..	<b>418</b>
Engine Oil Filter .....	360	Wheel And Wheel Trim Care.....	404	2.0L Engine .....	418
Engine Air Cleaner Filter .....	360	Snow Traction Devices .....	405	3.6L Engine .....	418
Draining Fuel/Water Separator Filter —		Tire Rotation Recommendations .....	406	Reformulated Gasoline.....	418
Diesel Engine.....	362	<b>DEPARTMENT OF TRANSPORTATION</b>		Materials Added To Fuel.....	418
Fuel Filter Replacement — Diesel Engine....	363	<b>UNIFORM TIRE QUALITY GRADES</b> .....	<b>406</b>	Gasoline/Oxygenate Blends .....	419
Priming If The Engine Has Run Out Of		Treadwear.....	406	Do Not Use E-85 In Non-Flex Fuel	
Fuel — Diesel Engine .....	364	Traction Grades.....	406	Vehicles .....	419
Intervention Regeneration Strategy —		Temperature Grades.....	407	CNG And LP Fuel System Modifications .....	419
Message Process Flow .....	365	<b>STORING THE VEHICLE</b> .....	<b>407</b>	MMT In Gasoline .....	419
Diesel Exhaust Fluid.....	365	<b>BODYWORK</b> .....	<b>408</b>	Fuel System Cautions .....	420
Accessory Drive Belt Inspection .....	366	Protection From Atmospheric Agents .....	408	<b>FUEL REQUIREMENTS — DIESEL ENGINE</b> .....	<b>420</b>
Air Conditioner Maintenance.....	366	Body And Underbody Maintenance.....	408	Diesel Fuel Specifications .....	421
Body Lubrication.....	368	Preserving The Bodywork .....	409	Biodiesel Fuel Requirements .....	421
				<b>FLUID CAPACITIES</b> .....	<b>423</b>
				<b>ENGINE FLUIDS AND LUBRICANTS</b> .....	<b>424</b>
				<b>CHASSIS FLUIDS AND LUBRICANTS</b> .....	<b>426</b>

## CUSTOMER ASSISTANCE

**SUGGESTIONS FOR OBTAINING SERVICE FOR****YOUR VEHICLE .....428**

Prepare For The Appointment ..... 428

Prepare A List ..... 428

Be Reasonable With Requests..... 428

**IF YOU NEED ASSISTANCE ..... 428**

FCA US LLC Customer Center..... 428

FCA Canada Inc. Customer Center..... 428

Mexico..... 428

Puerto Rico And US Virgin Islands..... 429

Customer Assistance For The Hearing Or

Speech Impaired

(TDD/TTY) ..... 429

Service Contract ..... 429

**WARRANTY INFORMATION .....429****MOPAR® PARTS .....430****REPORTING SAFETY DEFECTS .....430**

In The 50 United States And

Washington, D.C..... 430

In Canada ..... 430

**PUBLICATION ORDER FORMS .....430****GENERAL INFORMATION.....431**

# INTRODUCTION

Dear Customer,

Congratulations on the purchase of your new Jeep® vehicle. Be assured that it represents precision workmanship, distinctive styling, and high quality.



This is a specialized utility vehicle. It can go places and perform tasks that are not intended for conventional passenger vehicles. It handles and maneuvers differently from many passenger vehicles both on-road and off-road, so take time to become familiar with your vehicle. If equipped, the two-wheel drive version of this vehicle was designed for on-road use only. It is not intended for off-road driving or use in other severe conditions suited for a four-wheel drive vehicle. Before you start to drive this vehicle, read this Owner's Manual. Be sure you are familiar with all vehicle controls, particularly those used for braking, steering, transmission, and transfer case shifting. Learn how your vehicle handles on different road surfaces. Your driving skills will improve with experience. When driving off-road, or working the vehicle, don't overload the vehicle or expect the vehicle to overcome the natural laws of physics. Always observe federal, state, provincial and local laws wherever you drive. As with other vehicles of this type, failure to operate this vehicle correctly may result in loss of control or a collision ↪ page 200.

This Owner's Manual has been prepared with the assistance of service and engineering specialists to acquaint you with the operation and maintenance of your vehicle. It is supplemented by customer-oriented documents. Within this information, you will find a description of the services that FCA US LLC offers to its customers as well as the details of the terms and conditions for maintaining its validity. Please take the time to read all of these publications carefully before driving your vehicle for the first time. Following the instructions, recommendations, tips, and important warnings in this manual will help ensure safe and enjoyable operation of your vehicle.

This Owner's Manual describes all versions of this vehicle. Options and equipment dedicated to specific markets or versions are not expressly indicated in the text. Therefore, you should only consider the information that is related to the trim level, engine, and version that you have purchased. Any content introduced throughout the Owner's Information, which may or may not be applicable to your vehicle, will be identified with the wording "If Equipped" or, if applicable, refer to the "Hybrid Supplement" for additional information. All data contained in this publication are intended to help you use your vehicle in the best possible way. FCA US LLC aims at a constant improvement of the vehicles produced. For this reason, it reserves the right to make changes to the model described for technical and/or commercial reasons. For further information, contact an authorized dealer.

When it comes to service, remember that authorized dealers know your Jeep® best, have factory-trained technicians, genuine Mopar® parts, and care about your satisfaction.

## SYMBOLS KEY

<b>WARNING!</b>	These statements are against operating procedures that could result in a collision, bodily injury and/or death.
<b>CAUTION!</b>	These statements are against procedures that could result in damage to your vehicle.
<b>NOTE:</b>	A suggestion which will improve installation, operation, and reliability. If not followed, may result in damage.
<b>TIP:</b>	General ideas/solutions/suggestions on easier use of the product or functionality.
<b>PAGE REFERENCE ARROW</b> 	Follow this reference for additional information on a particular feature.
<b>FOOTNOTE</b> 	Supplementary and relevant information pertaining to the topic.

If you do not read this entire Owner's Manual, you may miss important information. Observe all Cautions and Warnings.

## ROLLOVER WARNING

Utility vehicles have a significantly higher rollover rate than other types of vehicles. This vehicle has a higher ground clearance and a higher center of gravity than many passenger vehicles. It is capable of performing better in a wide variety of off-road applications. Driven in an unsafe manner, all vehicles can go out of control. Because of the higher center of gravity, if this vehicle is out of control it may roll over while some other vehicles may not.

Do not attempt sharp turns, abrupt maneuvers, or other unsafe driving actions that can cause loss of vehicle control. Failure to operate this vehicle safely may result in a collision, rollover of the vehicle, and severe or fatal injury. Drive carefully.

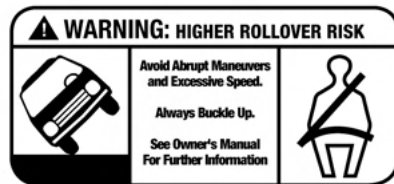

80bre010

**Rollover Warning Label**

Failure to use the driver and passenger seat belts provided is a major cause of severe or fatal injury. In fact, the US government notes that the universal use of existing seat belts could cut the highway death toll by 10,000 or more each year and could reduce disabling injuries by two million annually. In a rollover crash, an unbelted person is significantly more likely to die than a person wearing a seat belt. Always buckle up.

## VEHICLE MODIFICATIONS/ALTERATIONS

### WARNING!



Any modifications or alterations to this vehicle could seriously affect its roadworthiness and safety and may lead to a collision resulting in serious injury or death.









## SYMBOL GLOSSARY



Some car components have colored labels with symbols indicating precautions to be observed when using this component. It is important to follow all warnings when operating your vehicle. See below for the definition of each symbol → page 128.





### NOTE:









Warning and Indicator lights are different based upon equipment options and current vehicle status. Some telltales are optional and may not appear.



Red Warning Lights	
	Air Bag Warning Light → page 128
	Brake Warning Light → page 128
	Battery Charge Warning Light → page 129





Red Warning Lights	
	Door Open Warning Light → page 129
	Electric Power Steering (EPS) Fault Warning Light → page 129
	Electronic Throttle Control (ETC) Warning Light → page 129
	Engine Coolant Temperature Warning Light → page 130
	Hood Open Warning Light → page 130
	Oil Pressure Warning Light → page 130
	Oil Temperature Warning Light → page 130
	Seat Belt Reminder Warning Light → page 130









<b>Red Warning Lights</b>	
	Swing Gate Open Warning Light ↪ page 130
	Transmission Temperature Warning Light ↪ page 131
	Vehicle Security Warning Light ↪ page 131









<b>Yellow Warning Lights</b>	
	Anti-Lock Brake System (ABS) Warning Light ↪ page 131
	Electronic Stability Control (ESC) Active Warning Light ↪ page 131
	Electronic Stability Control (ESC) OFF Warning Light ↪ page 132
	Loose Fuel Filler Cap Warning Light ↪ page 132







<b>Yellow Warning Lights</b>	
	Low Fuel Warning Light ↪ page 132
	Low Washer Fluid Warning Light ↪ page 132
	Engine Check/Malfunction Indicator Warning Light (MIL) ↪ page 132
	AdBlue® (UREA) Injection System Failure Warning Light ↪ page 132
	Service 4WD Warning Light ↪ page 133
	Service Forward Collision Warning (FCW) Light ↪ page 133
	Service Stop/Start System Warning Light ↪ page 133
	Cruise Control Fault Warning Light ↪ page 133

Yellow Warning Lights	
	Sway Bar Fault Warning Light ⇨ page 134
	Tire Pressure Monitoring System (TPMS) Warning Light ⇨ page 133

Yellow Indicator Lights	
	4WD Indicator Light ⇨ page 134
	4WD Low Indicator Light ⇨ page 134
	4WD Part Time Indicator Light ⇨ page 134
	Axle Locker Fault Indicator Light ⇨ page 134
	Forward Collision Warning (FCW) OFF Indicator Light ⇨ page 135

Yellow Indicator Lights	
	Front And Rear Axle Lock Indicator Light ⇨ page 135
	Neutral Indicator Light ⇨ page 135
	Rear Axle Lock Indicator Light ⇨ page 135
	Service Adaptive Cruise Control Warning Light ⇨ page 135
	Sway Bar Indicator Light ⇨ page 135
	Wait To Start Light ⇨ page 135
	Low Diesel Emissions Additive AdBlue® (UREA) Indicator Light ⇨ page 135
	Water In Fuel Indicator Light ⇨ page 135

<b>Green Indicator Lights</b>	
	Adaptive Cruise Control (ACC) Set With No Target Detected Indicator Light ↪ page 135
	Adaptive Cruise Control (ACC) Set With Target Light ↪ page 136
	4WD Auto Indicator Light ↪ page 136
	Cruise Control SET Indicator Light ↪ page 136
	Front Fog Indicator Light ↪ page 136
	Parking/Headlights On Indicator Light ↪ page 136
	Stop/Start Active Indicator Light ↪ page 136
	Turn Signal Indicator Lights ↪ page 136

<b>White Indicator Lights</b>	
	Adaptive Cruise Control (ACC) Ready Light ↪ page 136
	2WD High Indicator Light ↪ page 136
	Hill Descent Control (HDC) Indicator Light ↪ page 136
	Selec-Speed Control Indicator Light ↪ page 136
	Cruise Control Ready Indicator Light ↪ page 137
	Cruise Control SET Indicator Light ↪ page 137



**Blue Indicator Lights**

High Beam Indicator Light  
↪ page 137

**Gray Indicator Lights**

Cruise Control Ready Indicator Light  
↪ page 137

# GETTING TO KNOW YOUR VEHICLE

## KEYS

### KEY FOB

Your vehicle is equipped with a key fob which supports Passive Entry, Remote Keyless Entry (RKE), Keyless Enter 'n Go™ (if equipped), and Remote Start (if equipped). The key fob allows you to lock or unlock the doors and swing gate from distances up to approximately 66 ft (20 m). The key fob does not need to be pointed at the vehicle to activate the system. The key fob also contains a mechanical key.

#### NOTE:

- The key fob's wireless signal may be blocked if the key fob is located next to a mobile phone, laptop, or other electronic device. This may result in poor performance.
- With the ignition on and the vehicle moving at 2 mph (4 km/h), all RKE commands are disabled.

#### WARNING!

Push the Mechanical Key Release Button only with the key fob facing away from your body, especially your eyes and objects that may be damaged, such as clothing.

#### CAUTION!

The electrical components inside of the key fob may be damaged if the key fob is subjected to strong electrical shocks. In order to ensure complete efficiency of the electronic devices inside of the key fob, avoid exposing the key fob to direct sunlight.

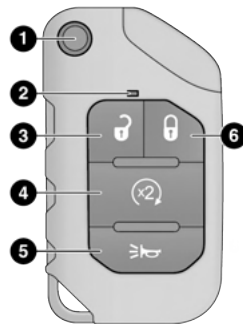

A0204000105US

**Key Fob**

- 1 – Mechanical Key Release Button
- 2 – LED Indicator
- 3 – Unlock Button
- 4 – Remote Start Button
- 5 – Panic Button
- 6 – Lock Button

**NOTE:**

- In case the ignition switch does not change with the push of a button, the key fob may have a low or fully depleted battery. A low key fob battery condition may be indicated by a message in the instrument cluster display, or by the LED light on the key fob. If the LED key fob light no longer illuminates from key fob button pushes, then the key fob battery requires replacement.
- Improper disposal of key fob batteries may be harmful to the environment. Please see an authorized dealer for proper battery disposal ↪ page 431.

**To Lock/Unlock The Doors And Swing Gate**

Push and release the unlock button on the key fob once to unlock the driver's door, or twice to unlock all the doors and swing gate. To lock all the doors, push the lock button once.

When the doors are unlocked, the turn signals will flash and the illuminated entry system will be activated. When the doors are locked, the turn signals will flash and the horn will chirp.

**NOTE:**

All doors can be programmed to unlock on the first push of the unlock button through the Uconnect Settings ↪ page 207.

**Key Left Vehicle Feature**

If a valid key fob is no longer detected inside the vehicle while the vehicle's ignition system is in the ON/RUN or START position, the message "Key Fob Has Left The Vehicle" will be shown in the instrument cluster display along with an interior chime. An exterior audible and visual alert will also be activated to warn the driver.

The vehicle's horn will rapidly chirp three times along with a single flash of the vehicle's exterior lights.

**NOTE:**

- The doors have to be open and then closed in order for the vehicle to check for the presence of a key fob; the Key Left Vehicle feature will not activate until all of the doors are closed.
- These alerts will not be activated in situations where the vehicle's engine is left running with the key fob inside.

**Replacing The Battery In The Key Fob**

The recommended replacement battery is CR2450.

**NOTE:**

- Customers are recommended to use a battery obtained from Mopar®. Aftermarket coin battery dimensions may not meet the original OEM coin battery dimensions.

- Perchlorate Material — special handling may apply. See [www.dtsc.ca.gov/hazardouswaste/perchlorate](http://www.dtsc.ca.gov/hazardouswaste/perchlorate) for further information.
  - Do not touch the battery terminals that are on the back housing or the printed circuit board.
  - When a key fob battery is low, a warning will be indicated on the vehicle's instrument cluster, and the fob LED will no longer illuminate with a button press.
1. Remove the back cover of the fob by inserting a flat-blade screwdriver into the slot on the bottom of the fob. Pry until the cover unsnaps being careful not to damage the seal. Proceed counterclockwise to pry the remaining snaps until the battery cover can be removed.



**1-3 - Back Cover Pry Points**

A0204000035US

2. Remove the depleted battery by inserting a small flat-blade screwdriver into the battery removal slot and sliding the battery forward and up being careful not to damage the electronic board underneath.

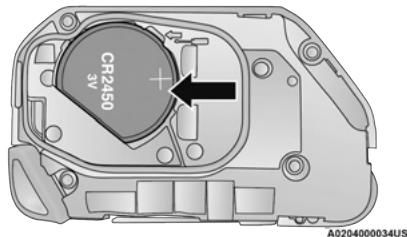

### Battery Replacement

3. Install the new battery into the key fob, making sure the positive (+) side is facing up. Slide the battery until it is seated securely below the tabs.
4. Reassemble the back cover making sure it is properly aligned before snapping it back in place.

### WARNING!

- The integrated key fob contains a coin cell battery. Do not ingest the battery; there is a chemical burn hazard. If the coin cell battery is swallowed, it can cause severe internal burns in just two hours and can lead to death.
- If you think a battery may have been swallowed or placed inside any part of the body, seek immediate medical attention.
- Keep new and used batteries away from children. If the battery compartment does not close securely, stop using the product and keep it away from children.

### Programming And Requesting Additional Key Fobs

Programming the key fob may be performed by an authorized dealer.

#### NOTE:

- Once a key fob is programmed to a vehicle, it cannot be repurposed and reprogrammed to another vehicle.
- Only key fobs that are programmed to the vehicle electronics can be used to start and operate the vehicle. Once a key fob is programmed to a vehicle, it cannot be programmed to any other vehicle.

### WARNING!

- Always remove the key fobs from the vehicle and lock all doors when leaving the vehicle unattended.
- Always remember to place the Keyless Enter 'n Go™ Ignition in the OFF position.

Duplication of key fobs may be performed at an authorized dealer. This procedure consists of programming a blank key fob to the vehicle electronics. A blank key fob is one that has never been programmed.

#### NOTE:

- When having the Sentry Key Immobilizer system serviced, bring all vehicle keys with you to an authorized dealer.
- Keys must be ordered to the correct key cut to match the vehicle locks.

### SENTRY KEY

The Sentry Key Immobilizer system prevents unauthorized vehicle operation by disabling the engine. The system does not need to be armed or activated. Operation is automatic, regardless of whether the vehicle is locked or unlocked.

The system uses a key fob, keyless push button ignition and a Radio Frequency (RF) receiver to prevent unauthorized vehicle operation. Therefore, only key fobs that are programmed to the vehicle can be used to start and operate the vehicle. The system cannot reprogram a key fob obtained from another vehicle.

After placing the ignition in the ON/RUN position, the Vehicle Security Light will turn on for three seconds for a bulb check. If the light remains on after the bulb check, it indicates that there is a problem with the electronics. In addition, if the light begins to flash after the bulb check, it indicates that someone attempted to start the engine with an invalid key fob. In the event that a valid key fob is used to start the engine but there is an issue with the vehicle electronics, the engine will start and shut off after two seconds.

If the Vehicle Security Light turns on during normal vehicle operation (vehicle running for longer than 10 seconds), it indicates that there is a fault in the electronics. Should this occur, have the vehicle serviced as soon as possible by an authorized dealer.

### CAUTION!

The Sentry Key Immobilizer system is not compatible with some aftermarket Remote Start systems. Use of these systems may result in vehicle starting problems and loss of security protection.

All of the key fobs provided with your new vehicle have been programmed to the vehicle electronics [page 431](#).

## IGNITION SWITCH

### KEYLESS ENTER 'N GO™ IGNITION

**If applicable, refer to the “Hybrid Supplement” for additional information.**

This feature allows the driver to operate the ignition switch with the push of a button as long as the key fob is in the passenger compartment.

The START/STOP ignition button has several operating modes that are labeled and will illuminate when in position. These modes are OFF, ACC, RUN, and START.

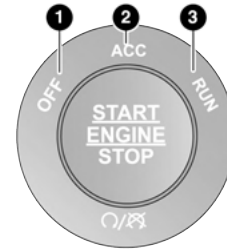

A0205000018US

**START/STOP Ignition Button**

- 1 — OFF
- 2 — ACC
- 3 — RUN

The push button ignition can be placed in the following modes:

#### OFF

- The engine is stopped.
- Some electrical devices (e.g. power locks, alarm, etc.) are available.

#### ACC

- Engine is not started.
- Some electrical devices are available.

**RUN**

- Driving position.
- All electrical devices are available.

**START**

- The engine will start.

**NOTE:**

In case the ignition switch does not change with the push of the START/STOP ignition button, the key fob may have a low or depleted battery. In this situation, a backup method can be used to operate the ignition switch. Put the nose side of the key fob (side with the mechanical flip key) against the START/STOP ignition button and push to operate the ignition switch.

**CAUTION!**

- Do not use the Mechanical Key against the START/STOP ignition button.
- Do not use sharp metal objects (e.g. screw-driver etc.) to pry the button out of the ignition switch. This button comes as an assembly, and is not removable. This can damage the silicone shield.

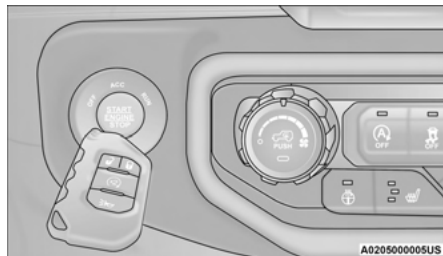
**Backup Starting Method****Do Not Use Mechanical Key****WARNING!**

- When exiting the vehicle, always remove the key fob from the vehicle and lock your vehicle.
- Never leave children alone in a vehicle, or with access to an unlocked vehicle.
- Allowing children to be in a vehicle unattended is dangerous for a number of reasons. A child or others could be seriously or fatally injured. Children should be warned not to touch the parking brake, brake pedal or the gear selector.
- Do not leave the key fob in or near the vehicle, or in a location accessible to children, and do not leave the Keyless Enter 'n Go™ Ignition in the ON/RUN position. A child could operate power windows, other controls, or move the vehicle.
- Do not leave children or animals inside parked vehicles in hot weather. Interior heat buildup may cause serious injury or death.

**CAUTION!**

An unlocked vehicle is an invitation for thieves. Always remove key fob from the vehicle and lock all doors when leaving the vehicle unattended.

**NOTE:**

- For more information on normal starting, see ↪ page 139.
- When opening the driver's door with the ignition in the ON/RUN position (engine not running), a chime will sound to remind you to place the ignition in the OFF position. In addition to the chime, the message will display "Ignition Or Accessory On" in the cluster.

## REMOTE START — IF EQUIPPED (GASOLINE)

If applicable, refer to the "Hybrid Supplement" for additional information.



This system uses the key fob to start the engine conveniently from outside the vehicle while still maintaining security.

The system has a range of 328 ft (100 m).

Remote Start is used to defrost windows in cold weather, and to reach a comfortable climate in all ambient conditions before the driver enters the vehicle.

**NOTE:**

- The vehicle must be equipped with an automatic transmission to be equipped with Remote Start.
- Obstructions between the vehicle and key fob may reduce this range ↪ page 431.

**WARNING!**

- Do not start or run an engine in a closed garage or confined area. Exhaust gas contains Carbon Monoxide (CO) which is odorless and colorless. Carbon Monoxide is poisonous and can cause serious injury or death when inhaled.
- Keep key fobs away from children. Operation of the Remote Start system, windows, door locks or other controls could cause serious injury or death.

**HOW TO USE REMOTE START**

Push and release the Remote Start button on the key fob twice within five seconds. The vehicle doors and swing gate will lock, the turn signals will flash twice, and the horn will chirp twice. Pushing the Remote Start button again will shut the engine off.

**NOTE:**

- With Remote Start, the engine will only run for 15 minutes.
- Remote Start can only be used twice.
- If an engine fault is present or fuel level is low, the vehicle will start and then shut down in 10 seconds.

- The parking lights will turn on and remain on during Remote Start mode.
- For security, power window operation is disabled when the vehicle is in the Remote Start mode.
- The ignition must be placed in the ON/RUN position before the Remote Start sequence can be repeated for a third cycle.

All of the following conditions must be met before the engine will remote start:

- Gear selector in PARK
- Doors closed
- Hood closed
- Swing gate closed
- Hazard switch off
- Brake switch inactive (brake pedal not pressed)
- Battery at an acceptable charge level
- Panic button not pushed
- System not disabled from previous Remote Start event
- Vehicle Security system indicator flashing
- Ignition in OFF position
- Fuel level meets minimum requirement
- All removable doors must not be removed
- Malfunction Indicator Light (MIL) not illuminated

**WARNING!**

- Do not start or run an engine in a closed garage or confined area. Exhaust gas contains Carbon Monoxide (CO) which is odorless and colorless. Carbon Monoxide is poisonous and can cause serious injury or death when inhaled.
- Keep key fobs away from children. Operation of the Remote Start system, windows, door locks or other controls could cause serious injury or death.

**TO EXIT REMOTE START MODE**

To drive the vehicle after starting the Remote Start system, either push and release the unlock button on the key fob to unlock the doors, or unlock the vehicle using Keyless Enter 'n Go™ — Passive Entry via the door handles, and disarm the Vehicle Security system (if equipped). Then, prior to the end of the 15 minute cycle, push and release the START/STOP ignition button.

The Remote Start system will turn the engine off if the Remote Start button on the key fob is pushed again, or if the engine is allowed to run for the entire 15 minute cycle. Once the ignition is placed in the ON/RUN position, the climate controls will resume previously set operations (temperature, blower control, etc.).

**NOTE:**

- To avoid unintentional shutdowns, the system will disable for two seconds after receiving a valid Remote Start request.
- For vehicles equipped with the Keyless Enter 'n Go™ — Passive Entry feature, the message "Remote Start Active — Push Start Button" will display in the instrument cluster display until you push the START/STOP ignition button.

**REMOTE START FRONT DEFROST ACTIVATION — IF EQUIPPED**

When Remote Start is active, and the outside ambient temperature is 40 °F (4.5 °C) or below, the system will automatically activate front defrost for 15 minutes or less. The time is dependent on the ambient temperature. Once the timer expires, the system will automatically adjust the settings depending on ambient conditions. See "Remote Start Comfort Systems — If Equipped" in the next section for detailed operation.

**REMOTE START COMFORT SYSTEMS — IF EQUIPPED**

When Remote Start is activated, the front and rear defrost will automatically turn on in cold weather. The heated steering wheel and driver heated seat feature will turn on if programmed in the comfort

menu screen within Uconnect Settings ↗ page 207. In warm weather, the driver vented seat feature will automatically turn on when the Remote Start is activated, if programmed in the comfort menu screen. The vehicle will adjust the climate control settings depending on the outside ambient temperature.

**Automatic Temperature Control (ATC) — If Equipped**

The climate controls automatically adjust to an optimal temperature and mode, dependent on the outside ambient temperature. When the ignition is placed in the ON/RUN position, the climate controls will resume their previous settings.

**Manual Temperature Control (MTC) — If Equipped**

- In ambient temperatures of 40 °F (4.5 °C) or below, the climate settings will default to maximum heat, with fresh air entering the cabin. If the front defrost timer expires, the vehicle will enter Mix mode.
- In ambient temperatures from 40 °F (4.5 °C) to 78 °F (26 °C), the climate settings will be based on the last settings selected by the driver.
- In ambient temperatures of 78 °F (26 °C) or above, the climate settings will default to MAX A/C, Bi-Level mode, with Recirculation on.

For more information on ATC, MTC, and climate control settings, see ↗ page 62.



**NOTE:**

These features will stay on through the duration of Remote Start, or until the ignition is placed in the ON/RUN position. The climate control settings will change, and exit the automatic defaults, if manually adjusted by the driver while the vehicle is in Remote Start mode. This includes turning the climate controls off using the OFF button.

### REMOTE START WINDSHIELD WIPER DE-ICER ACTIVATION — IF EQUIPPED

When Remote Start is active and the outside ambient temperature is less than 33°F (0.6°C), the Windshield Wiper De-Icer will activate. Exiting Remote Start will resume its previous operation. If the Windshield Wiper De-Icer was active, the timer and operation will continue.

### REMOTE START CANCEL MESSAGE

The following messages will display in the instrument cluster if the vehicle fails to remote start or exits Remote Start prematurely:

- Remote Start Cancelled — Door Open
- Remote Start Cancelled — Hood Open
- Remote Start Cancelled — Fuel Low
- Remote Start Cancelled — Swing Gate Open

- Remote Start Cancelled — Time Expired
- Remote Start Disabled — Start Vehicle To Reset

The message will stay active until the ignition is placed in the ON/RUN position.

### REMOTE START — IF EQUIPPED (DIESEL)



This system uses the key fob to start the engine conveniently from outside the vehicle while still maintaining security.

The system has a range of approximately 300 ft (91 m).

Remote Start is used to defrost windows in cold weather, and to reach a comfortable climate in all ambient conditions before the driver enters the vehicle.

**NOTE:**

- The vehicle must be equipped with an automatic transmission to be equipped with Remote Start.
- Obstructions between the vehicle and the key fob may reduce this range.
- The Remote Start system will wait for the Wait To Start Indicator Light → page 128 to extinguish before cranking the engine. This allows time for the engine pre-heat cycle to heat the cylinder air, and is normal in cold weather.

**WARNING!**

- Do not start or run an engine in a closed garage or confined area. Exhaust gas contains Carbon Monoxide (CO) which is odorless and colorless. Carbon Monoxide is poisonous and can cause serious injury or death when inhaled.
- Keep key fobs away from children. Operation of the Remote Start system, windows, door locks or other controls could cause serious injury or death.

2

### HOW TO USE REMOTE START

Push and release the Remote Start button on the key fob twice within five seconds. The vehicle doors and swing gate will lock, the turn signals will flash twice, and the horn will chirp twice. Pushing the Remote Start button again will shut the engine off.

**NOTE:**

- With Remote Start, the engine will only run for 15 minutes.
- Remote Start can only be used twice.
- If an engine fault is present or fuel level is low, the vehicle will start and then shut down in 10 seconds.

- The parking lights will turn on and remain on during Remote Start mode.
- For security, power window operation is disabled when the vehicle is in the Remote Start mode.
- The ignition must be placed in the ON/RUN position before the Remote Start sequence can be repeated for a third cycle.

All of the following conditions must be met before the engine will remote start:

- Gear selector in PARK
- Doors closed
- Hood closed
- Swing gate closed
- Hazard switch off
- Brake switch inactive (brake pedal not pressed)
- Battery at an acceptable charge level
- Panic button not pushed
- Fuel meets minimum requirement
- System not disabled from previous Remote Start event
- Vehicle Security system not active
- Malfunction Indicator Light (MIL) is not illuminated
- Water In Fuel Indicator Light is not illuminated
- Wait To Start Indicator Light is not illuminated

### WARNING!

- Do not start or run an engine in a closed garage or confined area. Exhaust gas contains Carbon Monoxide (CO) which is odorless and colorless. Carbon Monoxide is poisonous and can cause serious injury or death when inhaled.
- Keep key fobs away from children. Operation of the Remote Start system, windows, door locks or other controls could cause serious injury or death.

For additional Remote Start information, see [page 22](#).

## VEHICLE SECURITY SYSTEM — IF EQUIPPED

The Vehicle Security system monitors the vehicle doors for unauthorized entry and the ignition switch for unauthorized operation. When the alarm is activated, the interior switches for door locks are disabled. The Vehicle Security system provides both audible and visible signals. If something triggers the alarm, the Vehicle Security system will provide the following audible and visible signals: the horn will pulse, the park lamps and/or turn signals will flash, and the Vehicle Security Light in the instrument cluster will flash.

## TO ARM THE SYSTEM

Follow these steps to arm the Vehicle Security system:

1. Make sure the vehicle's ignition is placed in the OFF position.
2. Perform one of the following methods to lock the vehicle:
  - Push lock on the interior power door lock switch with the driver and/or passenger door open.
  - Push the lock button on the exterior Passive Entry door handle with a valid key fob available in the same exterior zone [page 26](#).
  - Push the lock button on the key fob.
3. If any doors are open, close them.

### NOTE:

The Vehicle Security system will not arm if you lock the doors using the manual door lock.

## TO DISARM THE SYSTEM

The Vehicle Security system can be disarmed using any of the following methods:

- Push the unlock button on the key fob.
- Grab the Passive Entry door handle (if equipped) [page 26](#).
- Cycle the vehicle ignition system out of the OFF position.

**NOTE:**

- The driver's door key cylinder cannot arm or disarm the Vehicle Security system.
- When the Vehicle Security system is armed, the interior power door lock switches will not unlock the doors.

The Vehicle Security system is designed to protect your vehicle. However, you can create conditions where the system will give you a false alarm. If one of the previously described arming sequences has occurred, the Vehicle Security system will arm regardless of whether you are in the vehicle or not. If you remain in the vehicle and open a door, the alarm will sound. If this occurs, disarm the Vehicle Security system.

If the Vehicle Security system is armed and the battery becomes disconnected, the Vehicle Security system will remain armed when the battery is reconnected; the exterior lights will flash, and the horn will sound. If this occurs, disarm the Vehicle Security system.

**REARMING OF THE SYSTEM**

If something triggers the alarm and no action is taken to disarm it, the Vehicle Security system will turn the horn off after a 29 second cycle (with five seconds between cycles and up to eight cycles if the trigger remains active) and then rearm itself.

**DOORS****CAUTION!**

Careless handling and storage of the removable door panels may damage the seals, causing water to leak into the vehicle's interior.

**MANUAL DOOR LOCKS**

All doors are equipped with an interior rocker-type door lock lever. To lock a door when leaving your vehicle, push the rocker lever forward to the lock position and close the door. To unlock the door, push the rocker lever rearward.

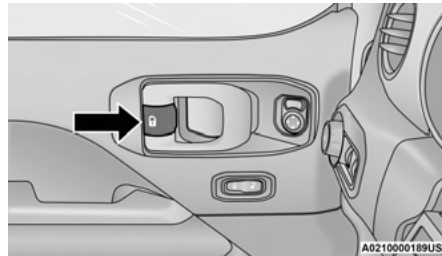
**Manual Door Lock****NOTE:**

The mechanical flip key can be used to lock or unlock the doors, swing gate (if equipped with a lock), glove compartment, and console storage.

**WARNING!****2**

- For personal security reasons and safety in a collision, lock the vehicle doors when you drive, as well as when you park and exit the vehicle.
- When exiting the vehicle, always switch off the ignition and remove the key from the vehicle. Unsupervised use of vehicle equipment may cause severe personal injuries and death.
- Never leave children alone in a vehicle, or with access to an unlocked vehicle.
- Allowing children to be in a vehicle unattended is dangerous for a number of reasons. A child or others could be seriously or fatally injured. Children should be warned not to touch the parking brake, brake pedal or the gear selector.
- Do not leave the key fob in or near the vehicle or in a location accessible to children. A child could operate power windows, other controls, or move the vehicle.

## POWER DOOR LOCKS — IF EQUIPPED

The power door lock switch is located on each front door panel. Push the switch forward to unlock the doors, and rearward to lock the doors.

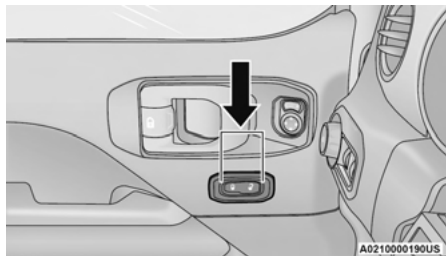

Power Door Lock Switch

### WARNING!

- For personal security reasons and safety in a collision, lock the vehicle doors when you drive, as well as when you park and exit the vehicle.
- When exiting the vehicle, always switch off the ignition and remove the key from the vehicle. Unsupervised use of vehicle equipment may cause severe personal injuries and death.

(Continued)

### WARNING!

- Never leave children alone in a vehicle, or with access to an unlocked vehicle.
- Allowing children to be in a vehicle unattended is dangerous for a number of reasons. A child or others could be seriously or fatally injured. Children should be warned not to touch the parking brake, brake pedal or the gear selector.
- Do not leave the key fob in or near the vehicle or in a location accessible to children. A child could operate power windows, other controls, or move the vehicle.

## KEYLESS ENTER 'N GO™ — PASSIVE ENTRY (IF EQUIPPED)

The Passive Entry system is a feature that allows you to lock and unlock the vehicle's door(s) and swing gate without having to push the key fob lock or unlock buttons.

### NOTE:

- Passive Entry may be programmed on/off within the Uconnect Settings ↗ page 207.
- The key fob may not be detected by the vehicle Passive Entry system if it is located next to a mobile phone, laptop, or other electronic device;

these devices may interfere with the key fob's wireless signal and prevent the Passive Entry system from locking/unlocking the vehicle.

- Passive Entry Unlock initiates illuminated approach (low beams, license plate lamp, position lamps) for whichever time duration is set between 0, 30, 60 or 90 seconds. Passive Entry Unlock also initiates two flashes of the turn signal lamps.
- If wearing gloves, or if it has been raining/snowing on the Passive Entry door handle, the unlock sensitivity can be affected, resulting in a slower response time.
- If the vehicle is unlocked by Passive Entry and no door is opened within 60 seconds, the vehicle will relock and, if equipped, will arm the Vehicle Security system.

### To Unlock From The Driver or Passenger Side

With a valid Passive Entry key fob within 5 ft (1.5 m) of the door handle, grab the handle to unlock the vehicle. Grabbing the driver's door handle will unlock the driver door automatically. Grabbing the passenger door handle will unlock all doors and the swing gate automatically.

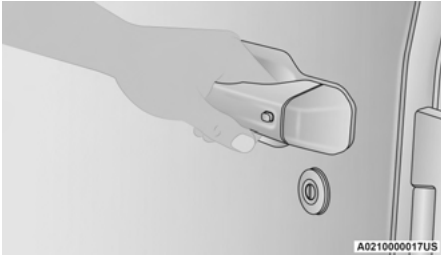
**Grab The Door Handle To Unlock****NOTE:**

Either the driver door only or all doors will unlock when you grab hold of the front driver's door handle, depending on the selected setting in the Uconnect system → page 207.

**Frequency Operated Button Integrated Key (FOBIK-Safe)**

To minimize the possibility of unintentionally locking a Passive Entry key fob inside your vehicle, the Passive Entry system is equipped with an automatic door unlock feature which will function only if the ignition switch is in the OFF position.

FOBIK-Safe only executes in vehicles with a START/STOP ignition. There are three situations that trigger a FOBIK-Safe search in any Passive Entry vehicle:

- A lock request is made by a valid Passive Entry key fob while a door is open.

- A lock request is made by the Passive Entry door handle while a door is open.
- A lock request is made by the door panel switch while the door is open.

When any of these situations occur, after all open doors are shut, the FOBIK-Safe search will be executed. If it detects a Passive Entry key fob inside the vehicle, the vehicle will unlock and alert the customer. If Passive Entry is disabled using Uconnect system, the key protection described in this section remains active/functional.

**NOTE:**

The vehicle will only unlock the doors during a FOBIK-Safe operation when a valid Passive Entry key fob is detected inside the vehicle. The vehicle will not unlock the doors when any of the following conditions are true:

- A second valid passive entry key fob is detected outside of the vehicle (within 5 ft (1.5 m) of a Passive Entry door handle).
- The doors are manually locked using the door lock knobs.
- Three attempts are made to lock the doors using the door panel switch, and then the doors are closed.

**To Lock The Vehicle's Doors And Swing Gate**

With one of the vehicle's Passive Entry key fobs within 5 ft (1.5 m) of the driver or passenger front

door handles, pushing the Passive Entry lock button will lock the vehicle doors and the swing gate.

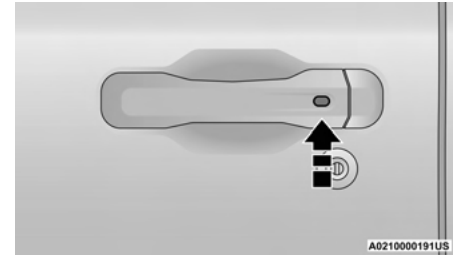
**Push The Door Handle Button To Lock****NOTE:**

DO NOT grab the door handle when pushing the door handle lock button. This could unlock the door(s).

**DO NOT Grab The Door Handle When Locking**

The vehicle doors can also be locked by using the lock button located on the vehicle's interior door panel.

### To Unlock/Enter The Swing Gate

The swing gate Passive Entry unlock feature is built into the swing gate handle. With a valid Passive Entry key fob within 5 ft (1.5 m) of the swing gate handle, grab the swing gate handle to unlock the swing gate automatically, and pull the swing gate to open.

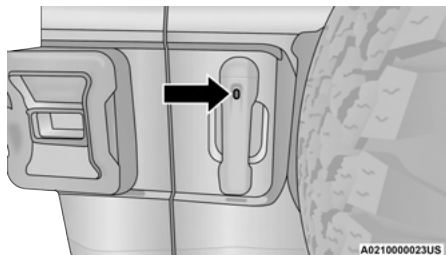

Swing Gate Passive Entry Lock Button

### To Lock The Swing Gate

With a valid Passive Entry key fob within 5 ft (1.5 m) of the swing gate handle, pushing the Passive Entry lock button will lock the vehicle doors and the swing gate.

### NOTE:

- After pushing the door handle button, you must wait two seconds before you can lock or unlock the doors, using any Passive Entry door handle. This is done to allow you to check if the vehicle is locked by pulling the door handle without the vehicle unlocking.
- If Passive Entry is disabled using the Uconnect Settings, the key protection described in "Frequency Operated Button Integrated Key (FOB/K-Safe)" remains active/functional.
- The Passive Entry system will not operate if the key fob battery is depleted → page 431.

### AUTOMATIC DOOR LOCKS — IF EQUIPPED

The Automatic Door Lock feature default condition is enabled. When enabled, the door locks will lock automatically when the vehicle's speed exceeds 15 mph (24 km/h). The Automatic Door Lock feature can be enabled or disabled by an authorized dealer per written request of the customer. Please see an authorized dealer for service.

### CHILD-PROTECTION DOOR LOCK SYSTEM — REAR DOORS

To provide a safer environment for small children riding in the rear seats, the rear doors are equipped with a Child-Protection Door Lock system.

To use the system, open each rear door, use a flat-blade screwdriver (or mechanical key) and rotate the dial to the lock or unlock position.

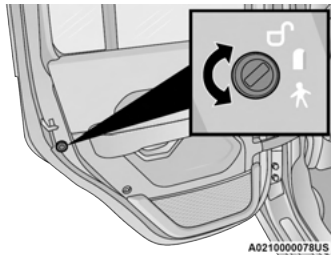

Child-Protection Door Lock Function

**NOTE:**

- When the Child-Protection Door Lock system is engaged, the door can be opened only by using the outside door handle even though the inside door lock is in the unlocked position.
- After disengaging the Child-Protection Door Lock system, always test the door from the inside to make certain it is in the unlocked position.
- After engaging the Child-Protection Door Lock system, always test the door from the inside to make certain it is in the locked position.
- For emergency exit with the system engaged, move the lock lever rearward (located on the door trim panel), roll down the window and open the door with the outside door handle.

**WARNING!**

Avoid trapping anyone in a vehicle in a collision. Remember that the rear doors can only be opened from the outside when the Child-Protection locks are engaged (locked).

**NOTE:**

Always use this device when carrying children. After engaging the child lock on both rear doors, check for effective engagement by trying to open a door with the internal handle. Once the

Child-Protection Door Lock system is engaged, it is impossible to open the doors from inside the vehicle. Before getting out of the car, be sure to check that there is no one left inside.

**FRONT DOOR REMOVAL****WARNING!**

Do not drive your vehicle on public roads with the doors removed as you will lose the protection they can provide. This procedure is furnished for use during off-road operation only.



Door Removal Warning Label

A0210000002US

**WARNING!**

- All occupants must wear seat belts during off-road operation with doors removed. For off-road driving tips, see ↪ page 200.
- Do not store detached doors inside of the vehicle, as they may cause personal injury in the event of an accident.

Outside rearview mirrors are mounted on the doors. If you choose to remove the doors, see an authorized dealer for a replacement cowl-mounted outside mirror. Federal law requires outside mirrors on vehicles for on-road use.

**NOTE:**

- Doors are heavy; use caution when removing them.
- Hinge pin can break if overtightened during door reinstall (Max Torque: 7.5 ft·lb / 10 N·m). For off-road driving tips, see ↪ page 200.
- When front doors are removed, the message “Blind Spot Alert Temporarily Unavailable” will display in the instrument cluster display. Power Mirrors and Power Door Locks will also be unavailable.

## 30 GETTING TO KNOW YOUR VEHICLE

To remove the front doors, proceed as follows:

1. Roll down the glass window to prevent any damage.
2. Remove the hinge pin screws from the upper and lower outside hinges (using a #T50 Torx head driver).

### NOTE:

The hinge pin screws and nuts can be stowed in the rear cargo tray located under the rear load floor.

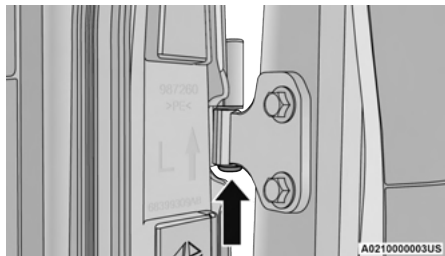

Hinge Pin Screw

3. Remove the plastic wiring access door under the instrument panel by sliding the plastic panel along the door frame toward the seats until the tabs are detached.

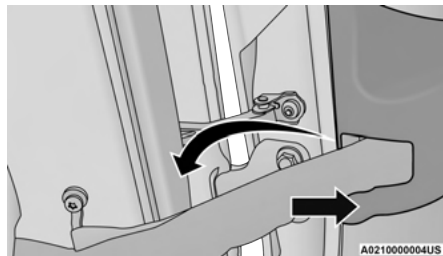

Wiring Access Door

### NOTE:

Do not force open; this will break the plastic cover.

4. Pull up on the red locking tab to unlock the wiring harness.

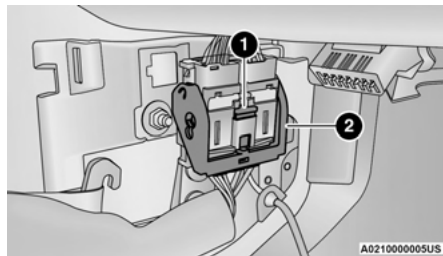

Closed Wiring Harness

- 1 - Red Locking Tab
- 2 - Wiring Harness Lever

5. Push and hold down the black security tab under the wiring harness, and lift the harness lever into the open position.

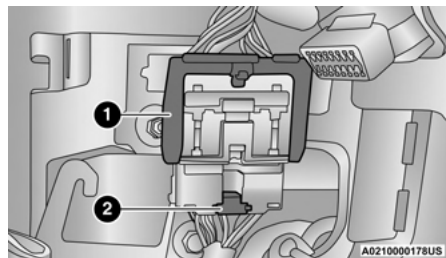

Open Wiring Harness

- 1 - Wiring Harness Lever (Open Position)
- 2 - Black Security Tab

6. With the wiring harness open, pull **straight** downward on the wiring connector to unplug. Store the wiring connector in the lower door basket.



- With the door in the open position, remove the check bolt from the door check attachment on the bodyside (using a #T40 Torx head driver).

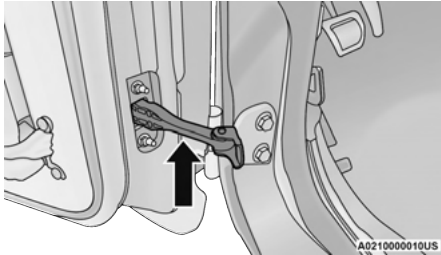

**Door Check (Detached)**

- With the door open, lift the door with the help of another person, to clear the hinge pins from their hinges and remove the door.

### To Install The Front Doors

- Locate the upper and lower hinge pins on the door, and lower them into the body hinges on the vehicle.

### NOTE:

The upper hinge pin is longer, which can be used to assist in guiding the door into place during installation.

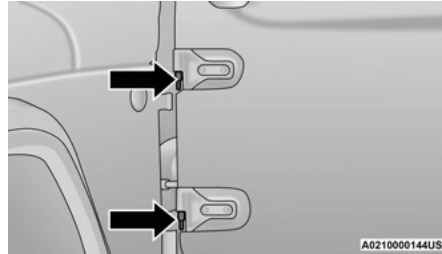

**Hinge Pin Locations**

- With the door in the open position, align the door check bracket with the hole on the bodyside. Insert the check screw and tighten using a #40 Torx head driver to 19.9 ft-lb (27.0 N-m).
- Insert the upper and lower hinge pin screws into the body hinges. Tighten the screws using a #T50 Torx head driver to 3.8 ft-lb / 5.2 N-m.

### CAUTION!

- Do not close the door before reattaching the door check to the body. Damage may occur to the door check.
- Do not overtighten Torx fasteners, damage to the vehicle's parts will occur.
- Hinge pins can break if overtightened during door install (Max Torque: 6.0 ft-lb/8.1 N-m).

### Replacing The Wiring Connector Into The Wiring Harness

To reinstall the wiring connector on the vehicle's door into the harness just inside the vehicle, proceed as follows:

### NOTE:

Make sure there is plenty of slack on the wiring connector during installation. Close the door slightly to provide more slack if needed.

1. With light finger pressure, seat the wiring connector **straight** into the wiring harness until the wiring harness lever starts to lower with the latching pin.

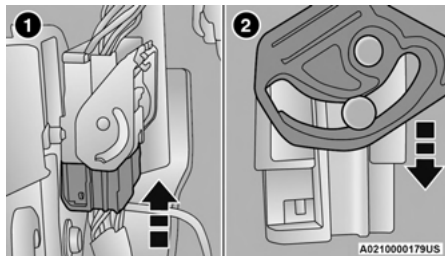

**Connecting The Wiring Harness**

- 1 – Seat Connector Straight Into Harness
- 2 – Wiring Harness Lever Starts To Lower

**CAUTION!**

Failure to correctly reconnect the wiring connector into the harness will result in damage that is not covered by the New Vehicle Warranty.

2. After the harness lever has started to move with the pressure of seating the wiring connector, continue by lowering the wiring harness lever to the fully closed position.

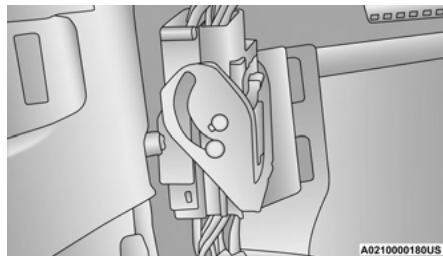

**Fully Closed Position**

3. Push the red locking tab downward to lock into place.
4. Attach the cloth strap of the door onto the metal hook just inside the vehicle.

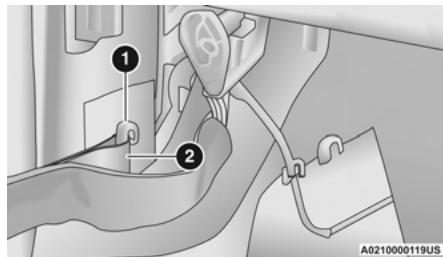

**Cloth Strap Attachment**

- 1 – Metal Hook
- 2 – Cloth Strap

5. Replace wiring access doors.

**REAR DOOR REMOVAL  
(FOUR-DOOR MODELS)**

**WARNING!**

Do not drive your vehicle on public roads with the doors removed as you will lose the protection they can provide. This procedure is furnished for use during off-road operation only.



A0210000002US

**Door Removal Warning Label**

**WARNING!**

- All occupants must wear seat belts during off-road operation with doors removed. For off-road driving tips, see ⇨ page 200.
- Do not store detached doors inside of the vehicle, as they may cause personal injury in the event of an accident.

**NOTE:**

- Doors are heavy; use caution when removing them.
  - Hinge pin can break if overtightened during door reinstall (Max Torque: 7.5 ft·lb / 10 N·m). For off-road driving tips, see ⇨ page 200.
1. Roll down the glass window to prevent any damage.
  2. Remove the hinge pin screws from the upper and lower outside hinges (using a #T50 Torx head driver).

**NOTE:**

The hinge pin screws and nuts can be stowed in the rear cargo tray located under the rear load floor.

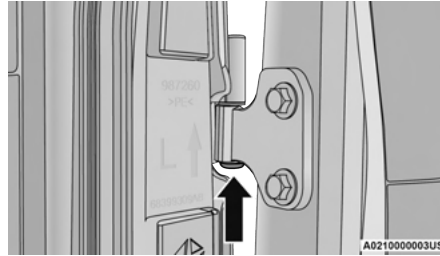
**Hinge Pin Screw**

3. Slide the front seat(s) fully forward.
4. Pry open and remove the plastic wiring access door from the bottom of the B-pillar.

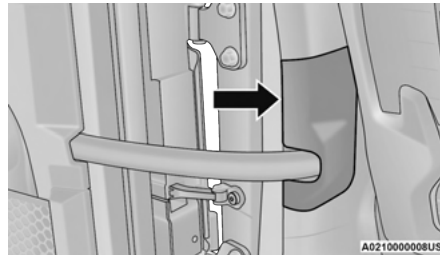
**Wiring Access Door**

5. Unplug the wiring connector.

**NOTE:**

Squeeze the tab on the base of the wiring harness. This will unlock the connector tab, allowing the wiring connector to be unplugged.

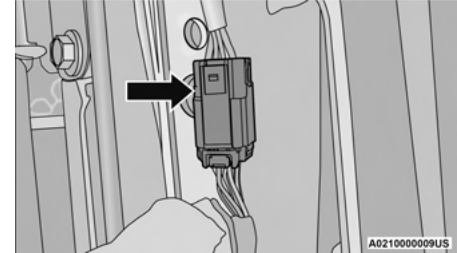
**Wiring Connector**

6. Remove the check screw from the center door check (using a #T40 Torx head driver).

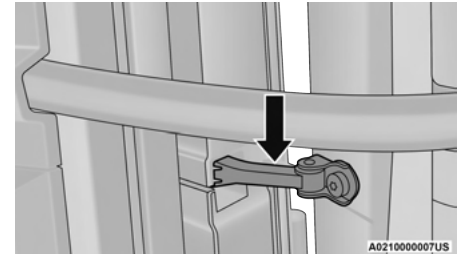
**Door Check (Attached)**

- With the door open, lift the door with the help of another person, to clear the hinge pins from their hinges and remove the door.

To reinstall the door(s), perform the previous steps in the reverse order.

**NOTE:**

The upper hinge has a longer pin, which can be used to assist in guiding the door into place when reinstalling.

**DOOR OFF MIRROR KIT — IF EQUIPPED**

If equipped with the Door Off Mirror Kit, exterior rearview mirrors can be installed on to the upper body door hinges after the front doors have been removed.

**WARNING!**

- All occupants must wear seat belts during off-road operation with doors removed. For off-road driving tips, see ↗ page 200.
- Do not store detached doors inside of the vehicle, as they may cause personal injury in the event of an accident.

Use this QR code to access your digital experience.



**Door Off Mirror**

To install the Door Off Mirrors, proceed as follows:

- Remove both front doors ↗ page 29.
- Remove the cowl bolt closest to the door opening using a #40 Torx head driver, and store in a safe location.

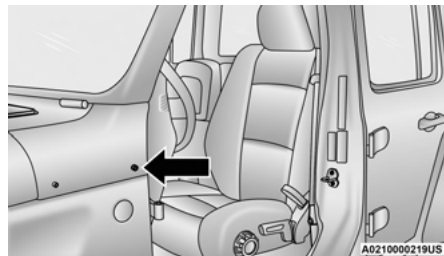

**Cowl Bolt Location**

- Push the mirror bracket forward onto the A-pillar, making sure to align the bottom of the bracket with the upper door hinge, and the hole from the removed cowl bolt.

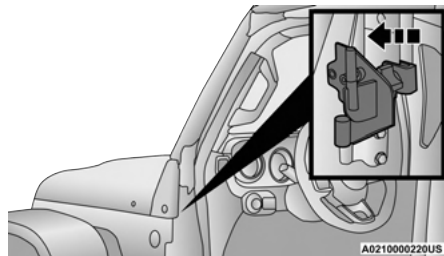

**Push Bracket Onto A-pillar**

4. Place the bracket bushing behind the mirror bracket (over the cowl bolt hole), then insert the bracket bolt into the mirror bracket, through the bracket bushing.



**Attaching Mirror Bracket To The Vehicle**

- 1 – Bracket Bushing  
2 – Bracket Bolt

5. Insert the hinge shoulder bolt through the bottom of the upper door hinge up into the mirror bracket, then rotate the bracket knob toward the rear of the vehicle to secure the mirror bracket to the A-pillar.

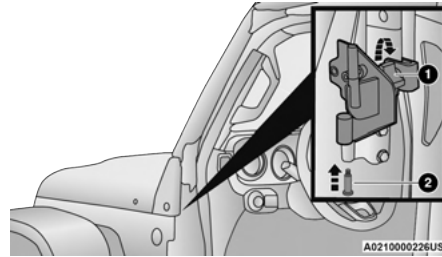

**Attaching Mirror Bracket To The Vehicle**

- 1 – Bracket Knob  
2 – Hinge Shoulder Bolt

6. Tighten both the bracket bolt and the hinge shoulder bolt with a #40 Torx head driver. Recommended torque specification for the bracket bolt is 6 ft-lb (8 N·m), and 7.5 ft-lb (10 N·m) for the hinge shoulder bolt.
7. Lower the mirror assembly onto the mirror bracket.

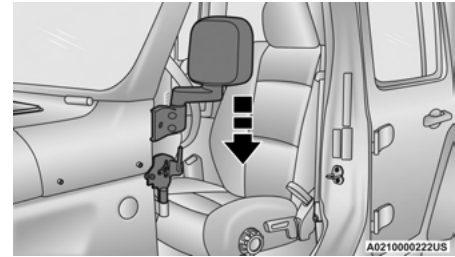

**Lower Mirror Assembly Onto Bracket**

8. Insert the three mirror screws into the mirror assembly, and tighten into the mirror bracket using a #30 Torx head driver. Recommended torque specification for the mirror screws is 4 ft-lb (5.5 N·m).

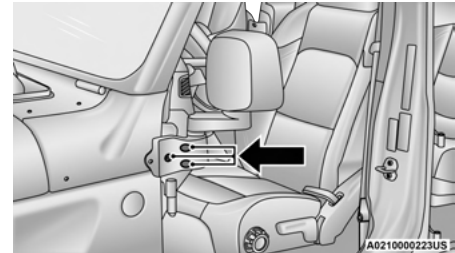

**Mirror Screw Locations**

- Repeat the steps on the other side of the vehicle.

**NOTE:**

If this kit is being installed with the optional lamp bracket, the bracket bushing from step 4 is not needed. Use the spacer from the lamp bracket.

## HALF-DOOR INSTALLATION — IF EQUIPPED

If applicable, refer to the “Hybrid Supplement” for additional information.

**CAUTION!**

- Do not run half-doors through an automatic car wash. This may result in scratches and wax buildup on the windows.
- Careless handling and storage of the half-doors may damage the seals resulting in water leaks into the interior of the vehicle.
- The upper half-doors must be positioned properly to ensure sealing. Improper installation can cause water leaks into the interior of the vehicle.

(Continued)

**CAUTION!**

- Store the zipper pulls of the upper half-door windows at the upper B-pillar area for both front and rear doors to avoid damage to the windows when not in use.
- Do not attempt to operate the half-door zipper in temperatures of 41 °F (5 °C) or below. Damage to the window may occur.

Use this QR code to access your digital experience.

This vehicle may be equipped with half-doors. To install the half-doors in the vehicle, follow the instruction sheet packaged in the box the doors were received in. Replacement parts may be purchased through Mopar® Service.



To install the front or rear half-doors, proceed as follows:

- Remove the full doors from the vehicle. For front door removal, see ⇨ page 29. For rear door removal, see ⇨ page 32.
- Locate the upper and lower hinge pins on the lower half-door, and lower them into the body hinges on the vehicle.

**NOTE:**

The upper hinge pin is longer, which can be used to assist in guiding the door into place during installation.

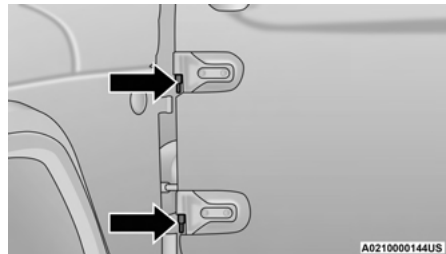

Lower Half-Door Hinge Pins

- Insert the upper and lower hinge pin screws into the body hinges. Tighten the screws using a #T50 Torx head driver to 3.8 ft·lb / 5.2 N·m.

**CAUTION!**

- Do not close the door before reattaching the door check to the body. Damage may occur to the door check.
- Do not overtighten Torx fasteners, damage to the vehicle's parts will occur.
- Hinge pins can break if overtightened during door install (Max Torque: 6.0 ft·lb/8.1 N·m).

4. Attach the cloth strap of the lower half-door to the metal hook just inside the vehicle.

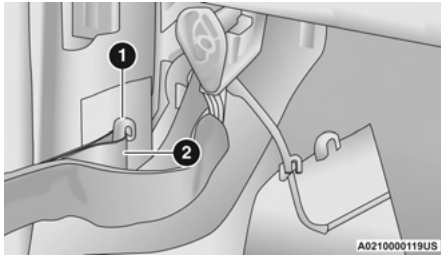

**Cloth Strap Attachment**

- 1 – Metal Hook  
2 – Cloth Strap

5. Connect the wiring harness on the lower half-door to the connection just inside the vehicle.

**NOTE:**

For front doors, make sure the wiring harness is closed completely.

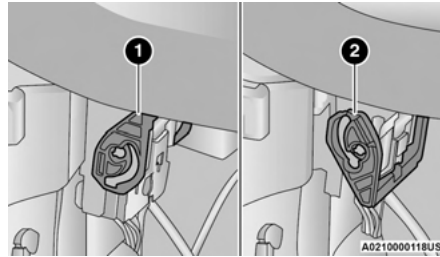

**Front Door Wiring Harness**

- 1 – Open Wiring Harness  
2 – Closed Wiring Harness

6. Replace wiring access doors.
7. When the half-doors are shipped with the vehicle, the lower half-doors will have plugs in the post holes that must be removed prior to upper half-door installation. To remove these plugs, proceed as follows:
- Locate the service hole in the center of each plug of the lower half-door (two on each front and rear door).
  - Place a tool (hook tool or trim stick is recommended) in the service hole.

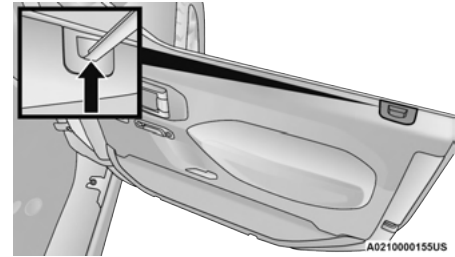

**Place Tool Into Service Hole Of Plug To Remove**

- c. Using the tool, slowly pull upwards from the center of the plug to remove.

8. Making sure the window on the upper half-door is completely zipped closed, insert the upper half-door into the lower half-door by placing the posts into the post holes.

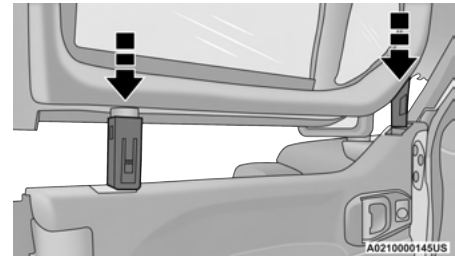

**Lower The Upper Half-Door Into Post Holes**

9. Push down firmly on the inside of the upper half-door until it is fully seated in the lower half.

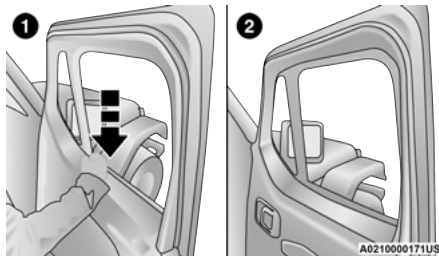

**Push Down To Fully Seat Upper Half-Door**

- 1 – Push Down On Inside Of Upper Half-Door  
2 – Fully Seated Upper Half-Door

### Door Latch Alignment

#### CAUTION!

Upon first installation of the half-doors, slowly set the door almost to the closing position and check how the door latch aligns with the body striker. Touch condition between these components can result in damage to both the door and the striker.

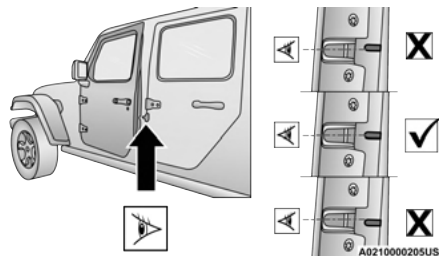

**Check Door Latch And Striker Alignment**

#### NOTE:

Only adjust the door to fit correctly against the striker. DO NOT adjust the striker, as this could affect the positioning of the full door.

If the door does not center align between the latch and the striker, proceed as follows:

1. Loosen (do not remove) the four bolts on the door hinges using the provided #T50 Torx head driver.

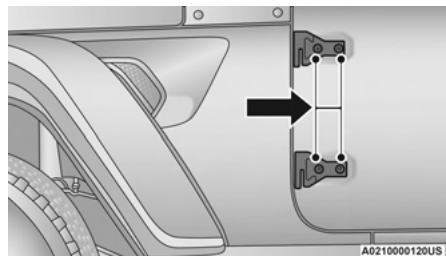

**Hinge Bolt Locations**

2. With the bolts loose, hold the door in the almost closed position, and check that the latch and striker align.
3. With the latch and striker aligned, proceed to close the door softly and tighten the hinge bolts to 20.3 ft·lb / 27.5 N·m (Max Torque: 27.3 ft·lb / 37 N·m).

### Lower Door Adjustment

#### CAUTION!

Upon first installation of the half-doors, slowly close each door to check for body contact. Improper setting of the door hinges can cause extreme non-uniform conditions, and result in damage to the body around the door.



If the door does not latch properly after installation, if there is interference between the panels, or if a non-uniform gap around the door is observed when the door is closed (example: door position appears to be low and too far rearward), the position of the door on its hinges may need to be adjusted. To do this, proceed as follows:

1. Loosen (do not remove) the four bolts on the door hinges using the provided #T50 Torx head driver.

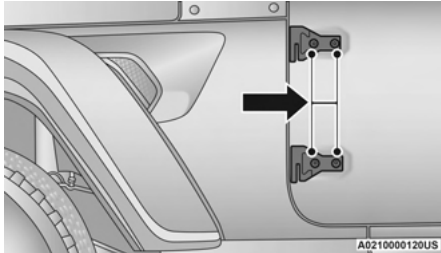

**Hinge Bolt Locations**

**NOTE:**

Do not adjust the body mounted hinges, or any part of the door latch, as modifications to these parts will affect installation of the full door.

2. With the bolts loose, the door can be moved forward by pushing the door handle toward the front of the vehicle, and/or upward by grabbing the door handle and lifting towards the roof.

3. Once the gaps between the door and vehicle body are uniform around the entire door, tighten the door hinge bolts to 20.3 ft·lb / 27.5 N·m (Max Torque: 27.3 ft·lb / 37 N·m).

**Upper Door Adjustment**

After installation of the half-doors, if water leaks or wind noise is observed, the seal of the upper half-door to the door opening may need to be adjusted.

To determine if the upper half-door needs to be adjusted, proceed as follows:

1. Determine which door is affected.
2. Open the affected door and hold a dollar-size piece of paper along the top of the door opening against the vehicle near where the leak/noise was observed. Make sure half of the paper is above the area where the door seal contacts the door opening, while the other half is below.
3. Close the door on the paper, then pull the paper upward. If the paper moves with little to no effort, the upper half-door will need to be adjusted in that area to increase seal compression.

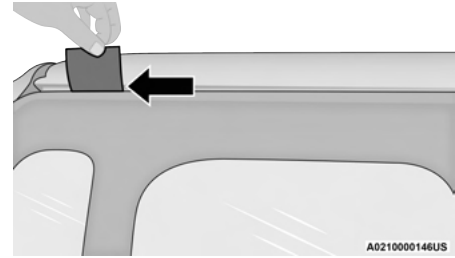

**Performing A Paper Test**

There is another optional test that can be performed using a flashlight and the help of another person.

One person should be inside the vehicle, and move the flashlight around the periphery of the door seal, shining outward. The other person should stand outside of the vehicle and check for light passing by the seal. If light is seen through the seal area, the door will need to be adjusted.

To adjust the seal compression, proceed as follows:

1. Open the door and lift the upper half-door up and away from the lower half. Lay the upper half-door on a clean, dry surface.
2. Using an 8 mm open-end wrench (not provided), loosen the nut located inside the bottom of the upper half-door post, closest to where the "paper test" detected a gap.

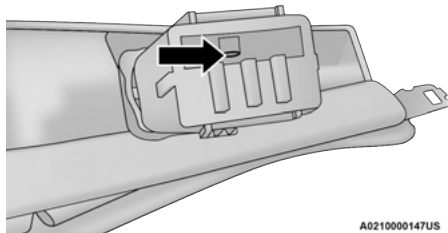

A0210000147US

**Nut Location Inside Bottom Of Post**

3. Using a 3 mm Allen wrench (not provided), rotate the screw on the side of the post counterclockwise (while holding the wrench on the loosened bolt) to increase the seal compression. If needed, rotate clockwise to reduce seal compression.

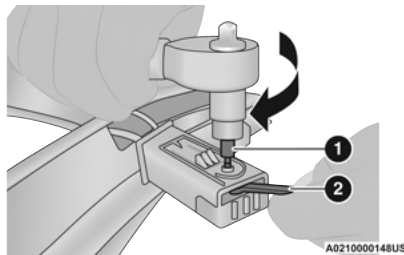

A0210000148US

**Rotate Screw For Seal Compression**

- 1 – 3 mm Allen Wrench
- 2 – 8 mm Open-End Wrench

4. Tighten the nut inside the bottom of the post using the wrench and make sure the screw head is flush to the post. Reinstall the upper half-door.

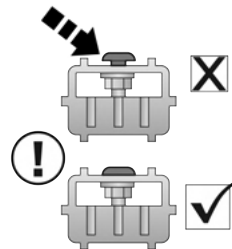

A0210000202US

**Screw Head Flush To Post**

5. Close the door and repeat the "paper test". Repeat the adjustment procedure if needed.

6. If needed, add the provided shim to a lower half-door pocket to seal the upper half-door to the roof:
- Lift upper half-door up and away from lower half.
  - Clean the bottom of the door pocket.

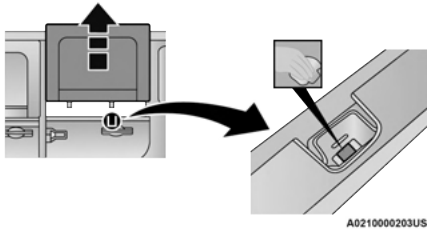

#### Remove Upper Half-Door & Clean Bottom Of Door Pocket

- Slide the shim onto a pencil or similar tool.
- Remove the paper backing from the adhesive side of the shim and place the shim with pencil into the pocket.
- Press the shim firmly to the bottom of the pocket, and remove the pencil once the shim is firmly in place.

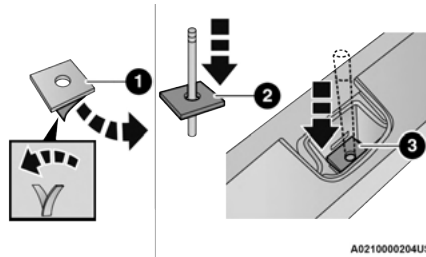

#### Press Shim Firmly Into Bottom Of Pocket

- Remove Paper Backing From Shim
- Slide Pencil through Hole In Shim
- Press Pencil With Shim Into Pocket

- Replace upper half-door.

#### NOTE:

If the compression is increased too much on the front upper corner of the rear doors, deformation of the seal will occur.

#### Half-Door Removal

To remove the half-doors, repeat the installation steps in reverse order.

#### NOTE:

When removing the upper half-doors, push upward firmly on the middle of the upper half-door until the posts detach from the lower half.

2

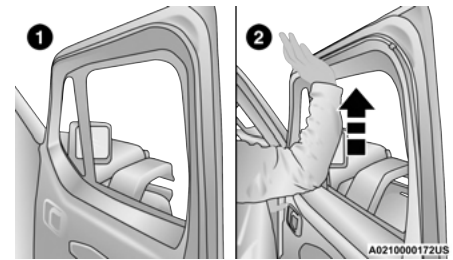

#### Push Upward To Remove Upper Half-Door

- Fully Seated Upper Half-Door
- Push Upward On Middle Of Upper Half-Door

## STEERING WHEEL

### TILT/TELESCOPING STEERING COLUMN

This feature allows you to tilt the steering column upward or downward. It also allows you to lengthen or shorten the steering column. The tilt/telescoping lever is located on the steering column.

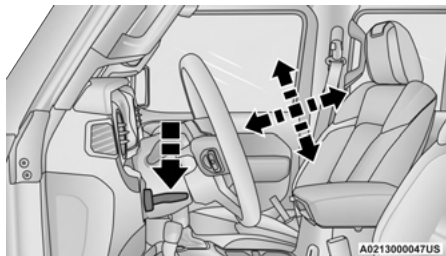

**Tilt/Telescoping Steering Column Lever**

To unlock the steering column, push the control handle downward (toward the floor). To tilt the steering column, move the steering wheel upward or downward as desired. To lengthen or shorten the steering column, pull the steering wheel outward or push it inward as desired. To lock the steering column in position, push the control handle upward until fully engaged.

#### WARNING!

Do not adjust the steering column while driving. Adjusting the steering column while driving or driving with the steering column unlocked, could cause the driver to lose control of the vehicle. Failure to follow this warning may result in serious injury or death.

### HEATED STEERING WHEEL — IF EQUIPPED



The steering wheel contains a heating element that helps warm your hands in cold weather. The heated steering wheel has only one temperature setting. Once the heated steering wheel has been turned on, it will stay on until the operator turns it off. The heated steering wheel may not turn on when it is already warm.

The heated steering wheel control button is located within the climate or controls screen of the touchscreen.

- Push the heated steering wheel button once to turn the heating element on.
- Push the heated steering wheel button a second time to turn the heating element off.

#### NOTE:

The engine must be running for the heated steering wheel to operate.

For information on use with the Remote Start system, see [page 22](#).

#### WARNING!

- Persons who are unable to feel pain to the skin because of advanced age, chronic illness, diabetes, spinal cord injury, medication, alcohol use, exhaustion, or other physical conditions must exercise care when using the steering wheel heater. It may cause burns even at low temperatures, especially if used for long periods.
- Do not place anything on the steering wheel that insulates against heat, such as a blanket or steering wheel covers of any type and material. This may cause the steering wheel heater to overheat.

## SEATS

Seats are a part of the Occupant Restraint system of the vehicle.

### WARNING!

- It is dangerous to ride in a cargo area, inside or outside of a vehicle. In a collision, people riding in these areas are more likely to be seriously injured or killed.
- Do not allow people to ride in any area of your vehicle that is not equipped with seats and seat belts. In a collision, people riding in these areas are more likely to be seriously injured or killed.
- Be sure everyone in your vehicle is in a seat and using a seat belt properly.

## MANUAL ADJUSTMENT FRONT SEATS

### Manual Front Seat Forward/Rearward Adjustment

The seat can be adjusted forward or rearward by using a bar located by the front of the seat cushion, near the floor. While sitting in the seat, lift up on the bar located under the seat cushion and move the seat forward or rearward. Release the bar once you

have reached the desired position. Then, using body pressure, move forward and rearward on the seat to be sure that the seat adjusters have latched.

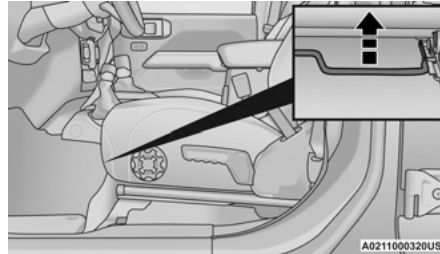

Adjustment Bar Location

### WARNING!

- Adjusting a seat while driving may be dangerous. Moving a seat while driving could result in loss of control which could cause a collision and serious injury or death.
- Seats should be adjusted before fastening the seat belts and while the vehicle is parked. Serious injury or death could result from a poorly adjusted seat belt.

### Manual Seat Height Adjustment

The driver's seat height can be raised or lowered by using the ratcheting handle, located on the outboard side of the seat. Pull upward on the handle to raise the seat, push downward on the handle to lower the seat. Several strokes may be necessary to achieve the desired position.

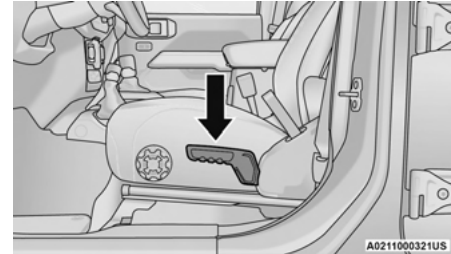

Seat Height Adjustment

### Manual Front Seat Recline Adjustment

To recline the seat, pull on the recline strap and lean forward or backward, depending on the direction you would like the seatback to move. Release the strap when the desired position is reached and the seatback will lock into place.

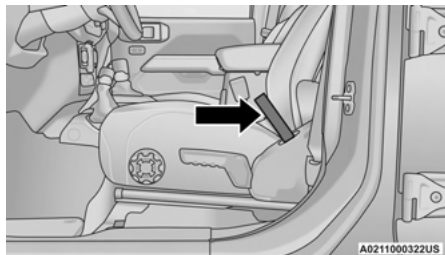

Recline Strap

#### WARNING!

Do not ride with the seatback reclined so that the shoulder belt is no longer resting against your chest. In a collision you could slide under the seat belt, which could result in serious injury or death.

### Lumbar Support

The lumbar control knob is located on the outboard side of the front driver seat. Rotate the control forward to increase and rearward to decrease the desired amount of lumbar support.

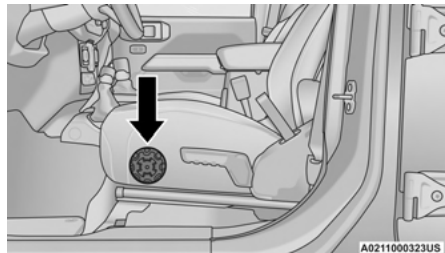

Lumbar Control Knob

### Front Passenger Easy Entry Seat — Two Door Models

Pull upward on the easy entry lever located on the outboard side of the seatback, and slide the entire seat forward.

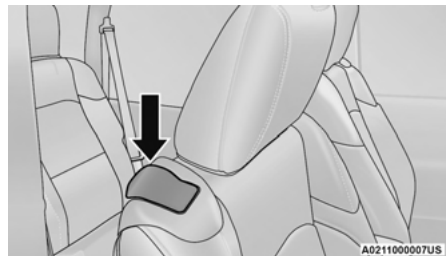

Easy Entry Lever

To return the seat to a sitting position, fold the seatback upright until it locks and push the seat rearward until the track locks.

#### NOTE:

- The front passenger seats have a track memory, which returns the seat to its original position.
- The recline strap and easy entry lever should not be used during the automatic returning of the seat to its sitting position.

## 60/40 SPLIT FOLDING REAR SEAT — FOUR DOOR MODELS

To provide additional storage area, each rear seat can be folded flat to allow for extended cargo space.

### NOTE:

- Be sure that the front seats are fully upright and positioned forward. This will allow the rear seat to fold down easily.
- The center head restraints must be in the lowest position to avoid contact with the center console when folding the seat.

### WARNING!

- It is extremely dangerous to ride in a cargo area, inside or outside of a vehicle. In a collision, people riding in these areas are more likely to be seriously injured or killed.
- Do not allow people to ride in any area of your vehicle that is not equipped with seats and seat belts.
- Be sure everyone in your vehicle is in a seat and using a seat belt properly.

## To Fold Down The Rear Seat

There are two release levers located on each upper outboard side of the rear seat. The larger of the two release levers folds down the seat and the head restraint simultaneously. The smaller lever folds down the head restraint independently for improved visibility.

To fold the seat, lift upward on the large release lever and slowly fold down the seatback. The head restraint will fold automatically with the seat when this lever is pulled.



Seatback Release Lever

### NOTE:

You may experience deformation in the seat cushion from the seat belt buckles if the seats are left folded for an extended period of time. This is

normal. By simply unfolding the seats to the open position, the seat cushion will return to its normal shape over time.

## To Raise The Rear Seat

Raise the seatback and lock it into place. Then, raise the head restraint until it locks into place. If interference from the cargo area prevents the seatback from fully locking, you will have difficulty returning the seat to its proper position.

### WARNING!

Be certain that the seatback is securely locked into position. If the seatback is not securely locked into position the seat will not provide the proper stability for child seats and/or passengers. An improperly latched seat could cause serious injury.

## FOLD AND TUMBLE REAR SEAT — TWO DOOR MODELS

### NOTE:

- Prior to folding the rear seat, it may be necessary to reposition the front seats.
- Be sure that the front seats are fully upright and positioned forward. This will allow the rear seat to fold down easily.

### Folding The Rear Seat

1. Lift the seatback release lever and fold the seatback forward.

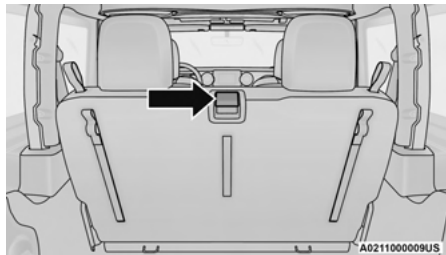

**Rear Seatback Release Lever**

2. Slowly flip the entire seat forward.

### Using The Retention Straps

1. There are two retention straps located on the back of the rear seat and two corresponding wire loops located on the back of each B-pillar. Open the hook-and-loop fastener on the strap and thread through the wire loop. Fold the hook-and-loop fastener over to keep the seat in the folded position. This should be done on both sides.



**Rear Seat Tumble Position Retention Strap**

2. To return the seat to its normal upright position, reverse these steps.

### Removing The Rear Seat

1. Push down on the release bar on each side, and pull the seat out and away from the lower bracket.

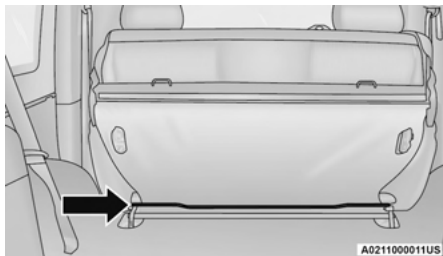

**Release Bar Location**

2. Remove the seat from the vehicle.
3. To reinstall the rear seat, just reverse these steps.

### NOTE:

Do not drive the vehicle without reattaching the rear seat latches.

### WARNING!

- It is extremely dangerous to ride in a cargo area, inside or outside of a vehicle. In a collision, people riding in these areas are more likely to be seriously injured or killed.
- Do not allow people to ride in any area of your vehicle that is not equipped with seats and seat belts.
- Be sure everyone in your vehicle is in a seat and using a seat belt properly.
- In a collision, you or others in your vehicle could be injured if seats are not properly latched to their floor attachments. Always be sure that the seats are fully latched.



## HEATED SEATS — IF EQUIPPED



The heated seat control buttons are located on the center instrument panel below the touchscreen and also in the Climate Control touchscreen menu.

- Push the heated seat button once to turn the HI setting on.
- Push the heated seat button a second time to turn the MED setting on.
- Push the heated seat button a third time to turn the LO setting on.
- Push the heated seat button a fourth time to turn the heating elements off.

### NOTE:

- The engine must be running for the heated seats to operate.
- The level of heat selected will stay on until the operator changes it.

For information on use with the Remote Start system, see ⇨ page 22.

### WARNING!

- Persons who are unable to feel pain to the skin because of advanced age, chronic illness, diabetes, spinal cord injury, medication, alcohol use, exhaustion or other physical condition must exercise care when using the seat heater. It may cause burns even at low temperatures, especially if used for long periods of time.
- Do not place anything on the seat or seatback that insulates against heat, such as a blanket or cushion. This may cause the seat heater to overheat. Sitting in a seat that has been overheated could cause serious burns due to the increased surface temperature of the seat.

## REAR SEAT ARMREST — IF EQUIPPED

The center part of the rear seat can also be used as a rear armrest with cupholders. To unfold it, grab the pull strap under the head restraint and pull it forward.



Rear Seat Armrest

### NOTE:

The cupholder liner can be removed for cleaning.

### WARNING!

Be certain that the seatback is securely locked into position. If the seatback is not securely locked into position the seat will not provide the proper stability for child seats and/or passengers. An improperly latched seat could cause serious injury.

## HEAD RESTRAINTS

Head restraints are designed to reduce the risk of injury by restricting head movement in the event of a rear impact. Head restraints should be adjusted so that the top of the head restraint is located above the top of your ear.

### WARNING!

- All occupants, including the driver, should not operate a vehicle or sit in a vehicle's seat until the head restraints are placed in their proper positions in order to minimize the risk of neck injury in the event of a crash.
- Head restraints should never be adjusted while the vehicle is in motion. Driving a vehicle with the head restraints improperly adjusted or removed could cause serious injury or death in the event of a collision.

### Front Head Restraints

To raise the head restraint, pull upward on the head restraint. To lower the head restraint, push the adjustment button located on the base of the head restraint, and push downward on the head restraint. The release button does not need to be pushed to adjust the head restraint.

To remove the head restraint, raise it as far as it can go then push the adjustment button and the

release button at the base of each post while pulling the head restraint up. To reinstall the head restraint, put the head restraint posts into the holes and push downward. Then adjust it to the appropriate height.

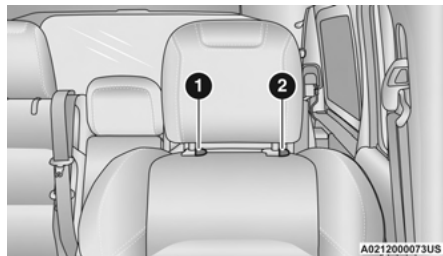

Front Head Restraint

- 1 – Release Button  
2 – Adjustment Button

### WARNING!

- A loose head restraint thrown forward in a collision or hard stop could cause serious injury or death to occupants of the vehicle. Always securely stow removed head restraints in a location outside the occupant compartment.

(Continued)

### WARNING!

- ALL the head restraints MUST be reinstalled in the vehicle to properly protect the occupants. Follow the reinstallation instructions prior to operating the vehicle or occupying a seat.

### NOTE:

Do not reposition the head restraint 180 degrees to the incorrect position in an attempt to gain additional clearance to the back of the head.

### Rear Head Restraints – Two Door Models

The rear seat is equipped with non-adjustable, but foldable head restraints.

To fold the outboard head restraint, pull on the release strap located on the upper outboard side of each rear seat.

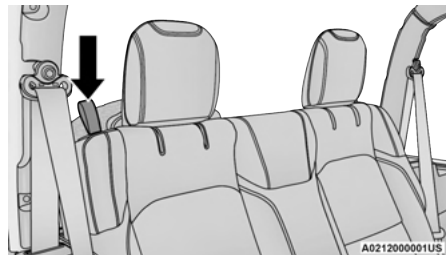

Rear Head Restraint Folding Strap Location

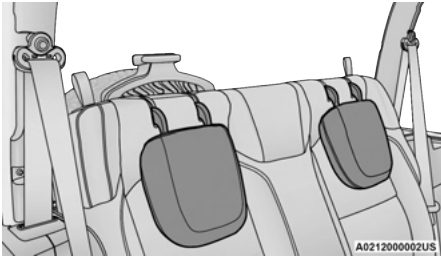

Rear Head Restraints Folded

To return the head restraint to its upward position, lift up on the head restraint until it locks into place. For information on child seat tether routing, see ↪ page 295.

**WARNING!**

- Do not drive the vehicle without the rear seat head restraints installed while passengers are occupying the rear seat. In a collision, people riding in this area without the head restraints installed are more likely to be seriously injured or killed.
- A loose head restraint thrown forward in a collision or hard stop could cause serious injury or death to occupants of the vehicle. Always securely stow removed head restraints in a location outside the occupant compartment.

(Continued)

**WARNING!**

- ALL the head restraints MUST be reinstalled in the vehicle to properly protect the occupants. Follow the reinstallation instructions prior to operating the vehicle or occupying a seat.

**Rear Head Restraints — Four Door Models**

The rear seat is equipped with nonadjustable, but foldable, outboard head restraints, as well as an adjustable, removable center head restraint.

To fold the outboard head restraint, pull on the inner release lever, located on the upper part of the rear seat.

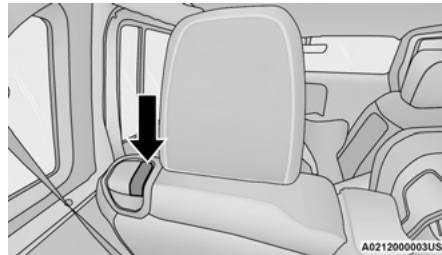

Rear Head Restraint Lever



Rear Head Restraint Folded

To return the head restraint to its upward position, lift up on the head restraint until it locks into place.

To raise the center head restraint, lift up on the head restraint. To lower the center head restraint, push the adjustment button, located at the base of the head restraint, and push down on the head restraint.

To remove the center head restraint, push the release button, located on the base of the head restraint, and pull upward on the head restraint.

To install the head restraint, hold the release button while pushing downward on the head restraint. For information on child seat tether routing, see ↪ page 295.

**NOTE:**

Lower the center head restraint to avoid contact with the center console when folding the seat down.

**WARNING!**

- Do not drive the vehicle without the rear seat head restraints installed while passengers are occupying the rear seat. In a collision, people riding in this area without the head restraints installed are more likely to be seriously injured or killed.
- A loose head restraint thrown forward in a collision or hard stop could cause serious injury or death to occupants of the vehicle. Always securely stow removed head restraints in a location outside the occupant compartment.
- ALL the head restraints MUST be reinstalled in the vehicle to properly protect the occupants. Follow the reinstallation instructions prior to operating the vehicle or occupying a seat.

**UCONNECT VOICE RECOGNITION****INTRODUCING VOICE RECOGNITION**

Start using Uconnect Voice Recognition with these helpful quick tips. It provides the key Voice Commands and tips you need to know to control your vehicle's Voice Recognition (VR) system.

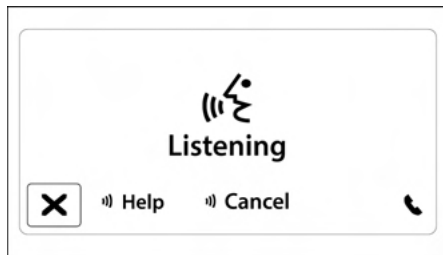
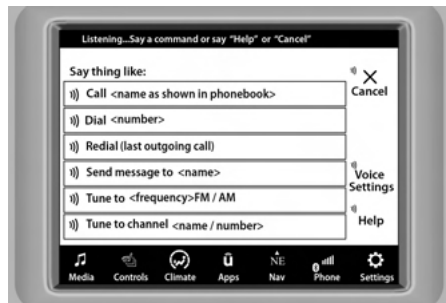
**Uconnect 3 With 5-inch Display****Uconnect 4 With 7-inch Display****Uconnect 4C/4C NAV With 8.4-inch Display****BASIC VOICE COMMANDS**

The following basic Voice Commands can be given at any point while using your Uconnect system.

Push the VR button on the steering wheel. After the beep, say:

- **“Cancel”** to stop a current voice session.
- **“Help”** to hear a list of suggested Voice Commands.
- **“Repeat”** to listen to the system prompts again.

Notice the visual cues that inform you of your Voice Recognition system's status.

## GET STARTED

The  VR button is used to activate/deactivate your Voice Recognition system.

Helpful hints for using Voice Recognition:

- Reduce background noise. Wind noise and passenger conversations are examples of noise that may impact recognition.
- Speak clearly at a normal pace and volume while facing straight ahead.
- Each time you give a Voice Command, first push the VR button, wait until after the beep, then say your Voice Command.
- You can interrupt the help message or system prompts by pushing the VR button and saying a Voice Command from the current category.

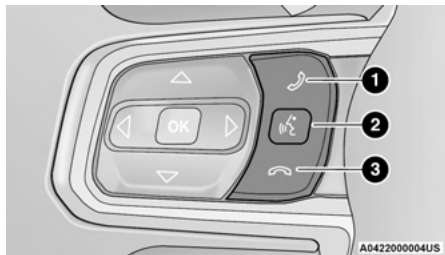

Uconnect Voice Command Buttons

- 1 — Push To Start Or Answer A Phone Call And Send Or Receive A Text
- 2 — Push The Voice Recognition Button To Begin Radio, Media, And Climate Functions
- 3 — Push To End Call

## ADDITIONAL INFORMATION

© 2021 FCA US LLC. All rights reserved. Mopar and Uconnect are registered trademarks and Mopar Owner Connect is a trademark of FCA US LLC. SiriusXM® and all related marks and logos are trademarks of SiriusXM® Radio Inc. ↪ page 431.

For Uconnect system support, call 1-877-855-8400 (24 hours a day 7 days a week) or visit [DriveUconnect.com](http://DriveUconnect.com) (US) or [DriveUconnect.ca](http://DriveUconnect.ca) (Canada).

## MIRRORS

### INSIDE REARVIEW MIRROR

#### Manual Mirror — If Equipped

The rearview mirror can be adjusted up, down, left, and right. The mirror should be adjusted to center on the view through the rear window.

Headlight glare from vehicles behind you can be reduced by moving the small control under the mirror to the night position (toward the rear of the vehicle). The mirror should be adjusted while set in the day position (toward the windshield).

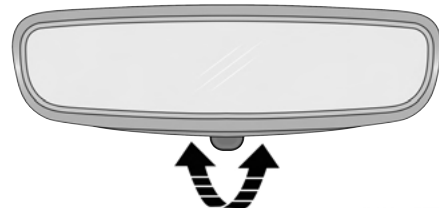

A0215000109US

#### Adjusting Rearview Mirror

### Automatic Dimming Mirror — If Equipped

The rearview mirror can be adjusted up, down, left, and right. The mirror should be adjusted to center on the view through the rear window.

The mirror automatically adjusts to headlight glare from vehicles behind you.

**NOTE:**

The Automatic Dimming feature is disabled when the vehicle is in REVERSE to improve the driver's view.



**Automatic Dimming Mirror**

The Automatic Dimming feature can be turned on or off through Uconnect Settings ⇨ page 207.

**CAUTION!**

To avoid damage to the mirror during cleaning, never spray any cleaning solution directly onto the mirror. Apply the solution onto a clean cloth and wipe the mirror clean.

**ILLUMINATED VANITY MIRRORS**

To access an illuminated vanity mirror, flip down one of the visors and lift the cover.

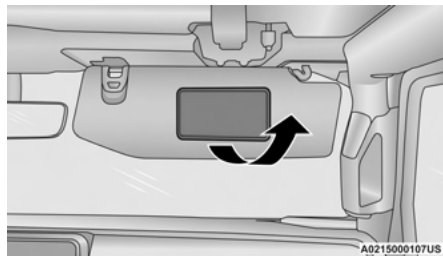

**Vanity Mirror**

**OUTSIDE MIRRORS**

The outside mirror(s) can be adjusted to the center of the adjacent lane of traffic to achieve the optimal view.

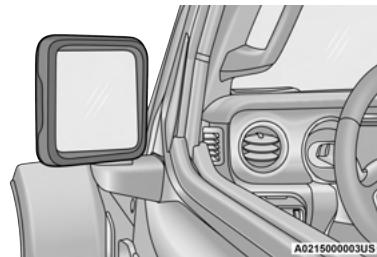

**Outside Rearview Mirror**

**WARNING!**

Vehicles and other objects seen in the passenger side convex mirror will look smaller and farther away than they really are. Relying too much on your passenger side mirror could cause you to collide with another vehicle or other object. Use your inside mirror when judging the size or distance of a vehicle seen in the passenger side mirror.

## HEATED MIRRORS — IF EQUIPPED



These mirrors are heated to melt frost or ice. This feature will be activated whenever you turn on the rear window defroster (if equipped) ↗ page 62.

## POWER MIRRORS — IF EQUIPPED

The power mirror controls are located on the door panel next to the door handle.

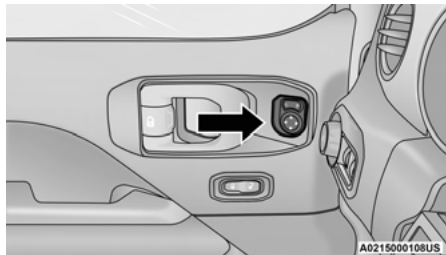

Power Mirror Switch

The power mirror controls consist of mirror select buttons and a four-way mirror control switch. To adjust a mirror, push either the L (left) or R (right) button to select the mirror that you want to adjust.

Using the mirror control switch, push any of the four arrows for the direction that you want the mirror to move.

## UNIVERSAL GARAGE DOOR OPENER (HOMELINK®) — IF EQUIPPED

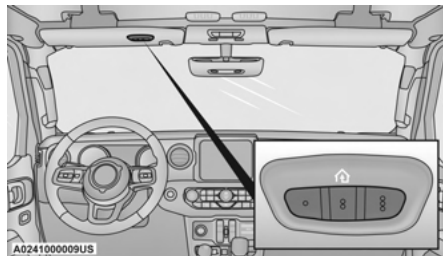

HomeLink® Buttons On Sun Visor

Use this QR code to access your digital experience.

- HomeLink® replaces up to three hand-held transmitters that operate devices such as garage door openers, motorized gates, lighting, or home security systems. The HomeLink® unit is powered by your vehicle's 12 Volt battery.
- The HomeLink® buttons that are located in the overhead console or sun visor designate the three different HomeLink® channels.



- To operate HomeLink®, push and release any of the programmed HomeLink® buttons. These buttons will activate the devices they are programmed to with each press of the corresponding HomeLink® button.
- The HomeLink® indicator light is located above the center button.

### NOTE:

HomeLink® is disabled when the Vehicle Security system is active ↗ page 431.

## BEFORE YOU BEGIN PROGRAMMING HOMELINK®

For efficient programming and accurate transmission of the radio-frequency signal, it is recommended that a new battery be placed in the hand-held transmitter of the device that is being programmed to the HomeLink® system. Make sure your hand-held transmitter is programmed to activate the device you are trying to program your HomeLink® button to.

Ensure that your vehicle is parked outside of the garage before you begin programming.

It is recommended that you erase all the channels of your HomeLink® before you use it for the first time.

## ERASING ALL THE HOMELINK® CHANNELS

To erase the channels, follow this procedure:

1. Place the ignition switch into the ON/RUN position.
2. Push and hold the two outside HomeLink® buttons (I and III) for up to 20 seconds, or until the HomeLink® indicator light flashes.

### NOTE:

Erasing all channels should only be performed when programming HomeLink® for the first time. Do not erase channels when programming additional buttons.

## IDENTIFYING WHETHER YOU HAVE A ROLLING CODE OR NON-ROLLING CODE DEVICE

Before programming a device to one of your HomeLink® buttons, you must determine whether the device has a rolling code or non-rolling code.

### Rolling Code Devices

To determine if your device has a rolling code, a good indicator is its manufacturing date. Typically, devices manufactured after 1995 have rolling codes. A device with a rolling code will also have a “LEARN” or “TRAIN” button located where the antenna is attached to the device. The button may

not be immediately visible when looking at the device. The name and color of the button may vary slightly by manufacturer.

### NOTE:

The “LEARN” or “TRAIN” button is not the button you normally use to operate the device.

### Non-rolling Code Devices

Most devices manufactured before 1995 will not have a rolling code. These devices will also not have a “LEARN” or “TRAIN” button.

## PROGRAMMING HOMELINK® TO A GARAGE DOOR OPENER

To program any of the HomeLink® buttons to activate your garage door opener motor, refer to the following steps:

### NOTE:

All HomeLink® buttons are programmed using this procedure. You do not need to erase all channels when programming additional buttons.

1. Place the ignition switch into the ON/RUN position.
2. Place the garage door opener transmitter 1 to 3 inches (3 to 8 cm) away from the HomeLink® button you wish to program, while keeping the HomeLink® indicator light in view.

3. Push and hold the HomeLink® button you want to program while you push and hold the garage door opener transmitter button you are trying to replicate.
4. Continue to hold both buttons and observe the HomeLink® indicator light. The HomeLink® indicator light will flash slowly and then rapidly. Once this happens, release both buttons.

### NOTE:

Make sure the garage door opener motor is plugged in before moving on to the rolling code/ non-rolling code final steps.

### Rolling Code Garage Door Opener Final Steps

### NOTE:

You have 30 seconds in which to initiate rolling code final step 2, after completing rolling code final step 1.

1. At the garage door opener motor (in the garage), locate the “LEARN” or “TRAIN” button. This can usually be found where the hanging antenna wire is attached to the garage door opener motor. Firmly push and release the “LEARN” or “TRAIN” button.
2. Return to the vehicle and push the programmed HomeLink® button three times (holding the button for two seconds each time). If the garage door opener motor operates, programming is complete.



3. Push the programmed HomeLink® button to confirm that the garage door opener motor operates. If the garage door opener motor does not operate, repeat the final steps for the rolling code procedure.

#### Non-Rolling Code Garage Door Opener Final Steps

1. Push and hold the programmed HomeLink® button and observe the HomeLink® indicator light. If the HomeLink® indicator light stays on constantly, programming is complete.
2. Push the programmed HomeLink® button to confirm that the garage door opener motor operates. If the garage door opener motor does not operate, repeat the steps from the beginning.

#### WARNING!

- Your motorized door or gate will open and close while you are programming the universal transceiver. Do not program the transceiver if people or pets are in the path of the door or gate.
- Do not run your vehicle in a closed garage or confined area while programming the transceiver. Exhaust gas from your vehicle contains Carbon Monoxide (CO) which is odorless and colorless. Carbon Monoxide is poisonous when inhaled and can cause you and others to be severely injured or killed.

## PROGRAMMING HOMELINK® TO A MISCELLANEOUS DEVICE

The procedure on how to program HomeLink® to a miscellaneous device follows the same procedure as programming to a garage door opener  
 ☞ page 54.

Be sure to determine if the device has a rolling code, or non-rolling code before beginning the programming process.

#### NOTE:

Canadian radio frequency laws require transmitter signals to time-out (or quit) after several seconds of transmission, which may not be long enough for HomeLink® to pick up the signal during programming. Similar to this Canadian law, some US gate operators are designed to time-out in the same manner. The procedure may need to be performed multiple times to successfully pair the device to your HomeLink® buttons.

## REPROGRAMMING A SINGLE HOMELINK® BUTTON

To reprogram a single HomeLink® button that has been previously trained, without erasing all the channels, refer to the following procedure. Be sure to determine if the new device you want to program the HomeLink® button to has a rolling code or a non-rolling code.

1. Place the ignition in the ON/RUN position, without starting the engine.
2. Push and hold the desired HomeLink® button until the HomeLink® Indicator light begins to flash after 20 seconds. **Do not release the button.**
3. **Without releasing the button**, proceed with Step 2 in “Programming HomeLink® To A Garage Door Opener” and follow all remaining steps.

## CANADIAN/GATE OPERATOR PROGRAMMING

For programming transmitters in Canada/United States that require the transmitter signals to “time-out” after several seconds of transmission.

Canadian radio frequency laws require transmitter signals to time-out (or quit) after several seconds of transmission – which may not be long enough for HomeLink® to pick up the signal during programming. Similar to this Canadian law, some U.S. gate operators are designed to time-out in the same manner.

It may be helpful to unplug the device during the cycling process to prevent possible overheating of the garage door or gate motor.

1. Place the ignition in the ON/RUN position.
2. Place the hand-held transmitter 1 to 3 inches (3 to 8 cm) away from the HomeLink® button you wish to program while keeping the HomeLink® indicator light in view.
3. Continue to press and hold the HomeLink® button, while you press and release (cycle) your hand-held transmitter every two seconds until HomeLink® has successfully accepted the frequency signal. The indicator light will flash slowly and then rapidly when fully trained.
4. Watch for the HomeLink® indicator to change flash rates. When it changes, it is programmed. It may take up to 30 seconds or longer in rare cases. The garage door may open and close while you are programming.
5. Press and hold the programmed HomeLink® button and observe the indicator light.

**NOTE:**

- If the indicator light stays on constantly, programming is complete and the garage door/device should activate when the HomeLink® button is pressed.
- To program the two remaining HomeLink® buttons, repeat each step for each remaining button. DO NOT erase the channels.

If you unplugged the garage door opener/device for programming, plug it back in at this time.

**Reprogramming A Single HomeLink® Button (Canadian/Gate Operator)**

To reprogram a channel that has been previously trained, follow these steps:

1. Place the ignition in the ON/RUN position.
2. Press and hold the desired HomeLink® button until the indicator light begins to flash after 20 seconds. Do not release the button.
3. Without releasing the button, proceed with “Canadian/Gate Operator Programming” step 2 and follow all remaining steps.

**SECURITY**

It is advised to erase all channels before you sell or turn in your vehicle.

To do this, push and hold the two outside buttons for 20 seconds until the indicator flashes. Note that all channels will be erased. Individual channels cannot be erased.

The HomeLink® Universal Transceiver is disabled when the Vehicle Security system is active.

**NOTE:**

The universal garage door opener only operates when the engine is running for security reasons associated with removable tops and doors.

**TROUBLESHOOTING TIPS**

If you are having trouble programming HomeLink®, here are some of the most common solutions:

- Replace the battery in the garage door opener hand-held transmitter.
- Push the LEARN button on the garage door opener to complete the training for a rolling code.
- Did you unplug the device for programming and remember to plug it back in?

If you have any problems, or require assistance, please call toll-free 1-800-355-3515 or, on the Internet at HomeLink.com for information or assistance.

**WARNING!**

- Vehicle exhaust contains carbon monoxide, a dangerous gas. Do not run your vehicle in the garage while programming the transceiver. Exhaust gas can cause serious injury or death.

*(Continued)*

**WARNING!**

- Your motorized door or gate will open and close while you are programming the universal transceiver. Do not program the transceiver if people, pets or other objects are in the path of the door or gate. Only use this transceiver with a garage door opener that has a “stop and reverse” feature as required by Federal safety standards. This includes most garage door opener models manufactured after 1982. Do not use a garage door opener without these safety features.

**EXTERIOR LIGHTS****HEADLIGHT SWITCH**

The headlight switch is located on the left side of the instrument panel. This switch controls the operation of the headlights, parking lights, automatic headlights (if equipped), instrument panel lights, interior lights, and fog lights (if equipped).

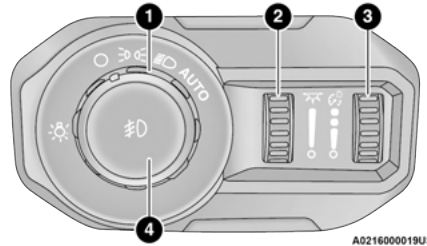
**Headlight Switch**

- 1 – Headlight Control
- 2 – Ambient Light Dimmer Control
- 3 – Instrument Panel Dimmer Control
- 4 – Fog Light Switch

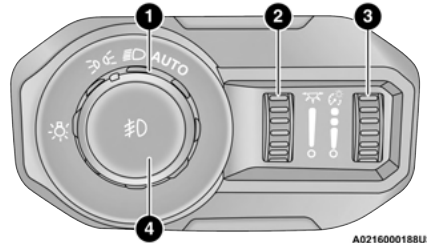
**Headlight Switch (Vehicles Sold In Canada)**

- 1 – Headlight Control
- 2 – Ambient Light Dimmer Control
- 3 – Instrument Panel Dimmer Control
- 4 – Fog Light Switch

**NOTE:**

Vehicles sold in Canada are equipped with a headlight switch with an AUTO and ON detent but without an OFF detent. Headlights will be deactivated when the headlight switch is placed in the parking lights position. However, the Daytime Running Lights (DRLs) will be activated along with the front and rear marker lights. The DRLs may be deactivated when the parking brake is engaged.

Rotate the headlight switch clockwise to the first detent for parking light and instrument panel light operation. Rotate the headlight switch to the second detent for headlight, parking light, and instrument panel light operation.

**NOTE:**

For vehicles sold in Canada, rotate the headlight switch clockwise from the parking lights and instrument panel lights position to the first detent to turn on headlights, parking lights, and instrument panel lights. Rotate the headlight switch to the second detent for the AUTO position.

## DAYTIME RUNNING LIGHTS (DRLs) — IF EQUIPPED

The Daytime Running Lights are active when the low beams are not on, and the engine is running. DRLs may be deactivated by applying the parking brake.

### NOTE:

- For vehicles sold in Canada, the Daytime Running Lights will automatically deactivate when the front fog lights are turned on.
- On some vehicles, the Daytime Running Lights may deactivate, or reduce intensity, on one side of the vehicle (when a turn signal is activated on that side), or on both sides of the vehicle (when the hazard warning lights are activated).

## HIGH/LOW BEAM SWITCH

Push the multifunction lever toward the instrument panel to switch the headlights to high beams. The lever will return to the centered position. To return the headlights to low beam, pull the lever toward the steering wheel, or push the lever toward the instrument panel.

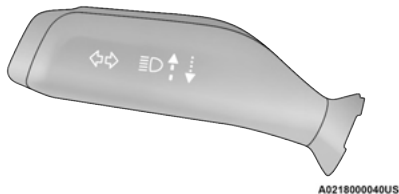

Multifunction Lever

## AUTOMATIC HIGH BEAM HEADLAMP CONTROL — IF EQUIPPED

The Automatic High Beam Headlamp Control system provides increased forward lighting at night by automatically controlling the high beams through the use of a camera mounted on the vehicle's header. This camera detects vehicle specific light and automatically switches from high beams to low beams until the approaching vehicle is out of view.

### NOTE:

- The Automatic High Beam Headlamp Control can be turned on or off by selecting "ON" under "Auto High Beam" within your Uconnect Settings ☞ page 207, as well as turning the headlight switch to the AUTO position and placing the multifunction lever in the high beam position.

- Broken, muddy, or obstructed headlights and taillights of vehicles in the field of view will cause headlights to remain on longer (closer to the vehicle). Also, dirt, film, and other obstructions on the windshield or camera lens will cause the system to function improperly.

## FLASH-TO-PASS

You can signal another vehicle with your headlights by lightly pulling the multifunction lever toward you. This will cause the high beam headlights to turn on, and remain on, until the lever is released.

## AUTOMATIC HEADLIGHTS — IF EQUIPPED

This system automatically turns the headlights on or off according to ambient light levels. To turn the system on, rotate the headlight switch clockwise to the last detent for automatic headlight operation. When the system is on, the headlight time delay feature is also on. This means the headlights will stay on for up to 90 seconds after you place the ignition into the OFF position. To turn the automatic system off, move the headlight switch out of the AUTO position.

### NOTE:

The engine must be running before the headlights will come on in the automatic mode.

## LIGHTS-ON REMINDER

If the headlights, parking lights, or cargo lights are left on after the ignition is placed in the OFF position, a chime will sound when the driver's door is opened.

## FRONT FOG LIGHTS — IF EQUIPPED

To activate the Front Fog Lights, turn on the parking lights or low beam headlights and push the fog light switch. Pushing the fog light switch a second time will turn the front fog lights off.

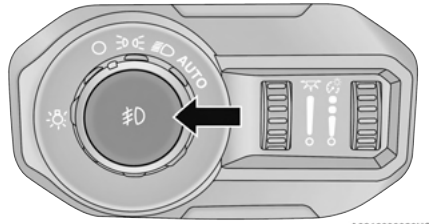

A021600020US

Front Fog Light Switch

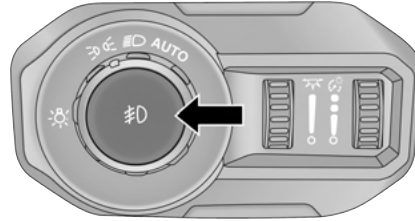

A0216000189US

Front Fog Light Switch (Vehicles Sold In Canada)

## TURN SIGNALS

Move the multifunction lever up or down to activate the turn signals. The arrows on each side of the instrument cluster flash to show proper operation.

### NOTE:

If either light remains on and does not flash, or there is a very fast flash rate, check for a defective outside light bulb.

## LANE CHANGE ASSIST — IF EQUIPPED

Lightly push the multifunction lever up or down, without moving beyond the detent, and the turn signal will flash three times then automatically turn off.

## INTERIOR LIGHTS

### INTERIOR COURTESY LIGHTS

The courtesy lights will turn on when the front doors are opened, by rotating the dimmer controls on the headlight switch fully upward, or, if equipped, when the unlock button is pushed on the key fob.

The interior courtesy lights are located in the center of the vehicle's sport bar, and consist of one large center light and four smaller reading lights. Each reading light can be turned on by pushing the lens. Pushing the lens a second time will turn the light off.

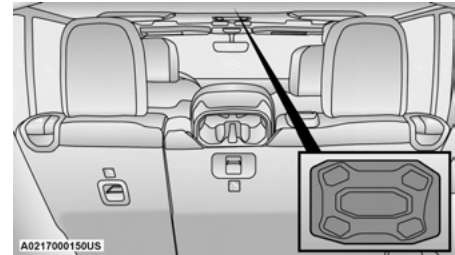

A0217000150US

Dome Lights

When a door is open and the interior lights are on, rotating the dimmer control to the extreme bottom position will cause all the interior lights to turn off.

This allows the doors to stay open for extended periods of time without discharging the vehicle's battery.

## DIMMER CONTROLS

The dimmer controls are part of the headlight switch and are located on the left side of the instrument panel.

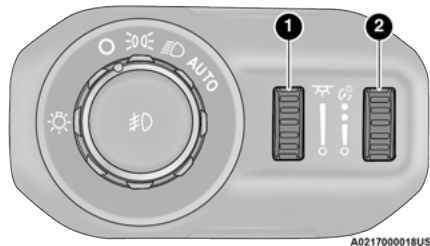

**Dimmer Controls**

- 1 – Ambient Light Dimmer Control
- 2 – Instrument Panel Dimmer Control

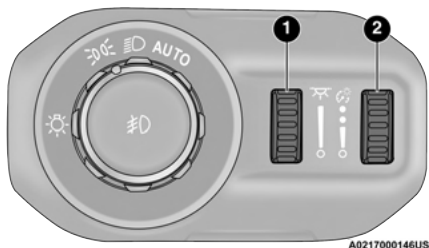

**Dimmer Controls (Vehicles Sold In Canada)**

- 1 – Ambient Light Dimmer Control
- 2 – Instrument Panel Dimmer Control

With the parking lights or headlights on, rotating the right dimmer control upward will increase the brightness of the instrument panel lights. Rotating the left dimmer control will adjust the interior and ambient light levels (e.g. courtesy lights in the footwell, illuminated cupholders, and front door handles).

## WINDSHIELD WIPERS AND WASHERS

The windshield wiper/washer control lever is located on the right side of the steering column. The front wipers are operated by rotating a switch, located at the end of the lever.

## WINDSHIELD WIPER OPERATION

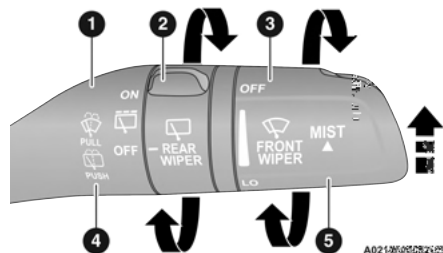

**Windshield Wiper/Washer Operation**

- 1 – Pull For Front Washer
- 2 – Rotate For Rear Wiper Operation
- 3 – Rotate For Front Wiper Operation
- 4 – Push Forward For Rear Washer
- 5 – Push Up For Mist

Rotate the end of the lever upward to the first detent past the intermittent settings for low-speed wiper operation. Rotate the end of the lever upward to the second detent past the intermittent settings for high-speed wiper operation.

**CAUTION!**

In cold weather, always turn off the wiper switch and allow the wipers to return to the park position before turning off the engine. If the wiper switch is left on and the wipers freeze to the windshield, damage to the wiper motor may occur when the vehicle is restarted.

**Intermittent Wipers**

Use the intermittent wiper when weather conditions make a single wiping cycle, with a variable pause between cycles, desirable. Rotate the end of the lever to the first detent position for one of four intermittent settings. The delay cycle can be set anywhere between 1 to 18 seconds.

**NOTE:**

The wiper delay times depend on vehicle speed. If the vehicle is moving less than 10 mph (16 km/h), delay times will be doubled.

**Windshield Washers**

To use the washer, pull the lever toward you and hold while spray is desired. If the lever is pulled while in the delay range, the wiper will start and continue to operate for two or three wipe cycles after the lever is released. Then, the intermittent interval previously selected will resume.

If the lever is pulled while in the off position, the wipers will operate for two or three wipe cycles. Then, the wipers will turn off.

**NOTE:**

As a protective measure, the washer will stop if the switch is held for more than 20 seconds. Once the switch is released the washer will resume normal operation.

**WARNING!**

Sudden loss of visibility through the windshield could lead to a collision. You might not see other vehicles or other obstacles. To avoid sudden icing of the windshield during freezing weather, warm the windshield with the defroster before and during windshield washer use.

**Mist**

Push upward on the wiper lever to activate a single wipe to clear off-road mist or spray from a passing vehicle. As long as the lever is held up, the wipers will continue to operate.

**NOTE:**

The mist feature does not activate the washer pump; therefore, no washer fluid will be sprayed on the windshield. The wash function must be used in order to spray the windshield with washer fluid.

For information on wiper care and replacement, see  page 368.

**REAR WINDOW WIPER/WASHER — IF EQUIPPED**

A rotary switch on the center portion of the windshield wiper/washer lever controls the operation of the rear wiper/washer function.



Rotate the switch upward to the first detent position for intermittent operation and to the second detent for continuous rear wiper operation.



Push the wiper lever toward the instrument panel to activate the rear washer. The washer pump and wiper will continue to operate as long as the lever is held.

**NOTE:**

As a protective measure, the washer will stop if the switch is held for more than 20 seconds. Once the switch is released the washer will resume normal operation.

If the rear wiper is operating when the ignition is placed in the OFF position, the wiper will automatically return to the “park” position. When the vehicle is restarted, the wiper will resume function at whichever position the switch is set at.

## CLIMATE CONTROLS

The Climate Control system allows you to regulate the temperature, air flow, and direction of air circulating throughout the vehicle. The controls are located on the touchscreen (if equipped) and on the instrument panel below the radio.

### AUTOMATIC CLIMATE CONTROL DESCRIPTIONS AND FUNCTIONS



**Uconnect 4 With 7-inch Display Automatic Climate Controls**



**Uconnect 4C/4C NAV With 8.4-inch Display Automatic Climate Controls**

### MAX A/C Button



Press and release the MAX A/C button on the touchscreen to change the current setting to the coldest output of air. The MAX A/C indicator illuminates when MAX A/C is on. Pressing the button again will cause the MAX A/C operation to exit.

#### NOTE:

The MAX A/C button is only available on the touchscreen.

MAX A/C sets the control for maximum cooling performance. The button illuminates when MAX A/C is on. In MAX A/C, the blower level and mode position can be adjusted to desired user settings. Pressing other settings will cause the MAX A/C to turn off.

### A/C Button



Press and release this button on the touchscreen, or push the button on the faceplate to change the current setting. The A/C indicator illuminates when A/C is on.

The A/C button allows the operator to manually activate or deactivate the A/C system. When the A/C system is turned on, cool dehumidified air will flow through the outlets into the cabin.

### Recirculation Button



Press and release this button on the touchscreen, or push the button on the faceplate, to change the system between recirculation mode and outside air mode.

The Recirculation indicator and the A/C indicator illuminate when the Recirculation button is pressed. Recirculation can be used when outside conditions, such as smoke, odors, dust, or high humidity are present. Recirculation can be used in all modes. Recirculation may be unavailable (button on the touchscreen greyed out) if conditions exist that could create fogging on the inside of the windshield. The A/C can be deselected manually without disturbing the mode control selection. Continuous use of the Recirculation mode may make the inside air stuffy and window fogging may occur. Extended use of



this mode is not recommended. Recirculation mode may automatically adjust to optimize customer experience for warming, cooling, dehumidification, etc.

In cold weather, use of Recirculation mode may lead to excessive window fogging.

## AUTO Button

 Set your desired temperature and press and release the AUTO button on the touchscreen, or push the button on the faceplate. AUTO will achieve and maintain your desired temperature by automatically adjusting the blower speed and air distribution. Air Conditioning (A/C) may be active during AUTO operation to improve performance. AUTO mode is highly recommended for efficiency. You can press and release this button on the touchscreen, or push the button on the faceplate, to turn AUTO on. The AUTO indicator illuminates when AUTO is on. Toggling this function will cause the system to switch between manual mode and automatic mode [↔ page 67](#).

## Front Defrost Button

 Press and release this button on the touchscreen, or push and release the button on the faceplate, to change the current airflow setting to Defrost mode. The Front Defrost indicator illuminates when Front Defrost is on. Air comes from the windshield and

side window demist outlets. When the defrost button is selected, the blower level may increase. Use Defrost mode with maximum temperature settings for best windshield and side window defrosting and defogging. When toggling the front defrost mode button, the climate system returns to the previous setting.

## Rear Defrost Button

 Press and release the Rear Defrost button on the touchscreen, or push and release the button on the faceplate, to turn on the rear window defroster and the heated outside mirrors (if equipped). The Rear Defrost indicator illuminates when the rear window defroster is on. The rear window defroster automatically turns off after 10 minutes.

### CAUTION!

Failure to follow these cautions can cause damage to the heating elements:

- Use care when washing the inside of the rear window. Do not use abrasive window cleaners on the interior surface of the window. Use a soft cloth and a mild washing solution, wiping parallel to the heating elements. Labels can be peeled off after soaking with warm water.

*(Continued)*

### CAUTION!

- Do not use scrapers, sharp instruments, or abrasive window cleaners on the interior surface of the window.
- Keep all objects a safe distance from the window.

2

## Driver And Passenger Temperature Up And Down Buttons

Provides the driver and passenger with independent temperature control.



Push the red button on the faceplate or touchscreen or press and slide the temperature bar towards the red arrow button on the touchscreen for warmer temperature settings.



Push the blue button on the faceplate or touchscreen or press and slide the temperature bar towards the blue arrow button on the touchscreen for cooler temperature settings.

### NOTE:

The numbers within the temperature display will only appear if your vehicle is equipped with an Automatic Climate Control system.

## SYNC Button



Press the SYNC button on the touchscreen to toggle the SYNC feature on/off. The SYNC indicator illuminates when SYNC is on. SYNC synchronizes the

passenger temperature setting with the driver temperature setting. Changing the passenger's temperature setting while in SYNC will automatically exit this feature.

### NOTE:

The SYNC button is only available on the touchscreen.

## Blower Control



Blower Control regulates the amount of air forced through the Climate Control system. Adjusting the blower will cause automatic mode to switch to manual

operation. There are seven blower speeds available. The speeds can be selected using either the blower control knob on the faceplate or the buttons on the touchscreen.

- **Faceplate:** The blower speed increases as you turn the blower control knob clockwise from the lowest blower setting. The blower speed decreases as you turn the blower control knob counterclockwise.

- **Touchscreen:** Use the small blower icon to reduce the blower setting and the large blower icon to increase the blower setting. The blower can also be selected by pressing the blower bar area between the icons.

## Mode Control



Select one of the Mode buttons on the touchscreen or press the Mode button on the faceplate to adjust the airflow distribution. The airflow distribution can be adjusted so air comes from the instrument panel outlets, floor outlets, defrost outlets, and demist outlets.

## Panel Mode



Air comes from the outlets in the instrument panel. Each of these outlets can be individually adjusted to direct the flow of air. The air vanes of the center outlets and outboard outlets can be moved up and down or side to side to regulate airflow direction. There is a shut-off wheel located below the air vanes to shut off or adjust the amount of airflow from these outlets.

## Bi-Level Mode



Air comes from the instrument panel outlets and floor outlets. A slight amount of air is directed through the defrost and side window demister outlets.

### NOTE:

Bi-Level mode is designed under comfort conditions to provide cooler air out of the panel outlets and warmer air from the floor outlets.

## Floor Mode



Air comes from the floor outlets. A slight amount of air is directed through the defrost and side window demister outlets.

## Mix Mode



Air is directed through the floor, defrost, and side window demister outlets. This setting works best in cold or snowy conditions that require extra heat to the windshield. This setting is good for maintaining comfort while reducing moisture on the windshield.

## Climate Control OFF Button



Press and release the OFF button on the touchscreen, or push the OFF button on the faceplate to turn the Climate Control ON/OFF.

## MANUAL CLIMATE CONTROL DESCRIPTIONS AND FUNCTIONS

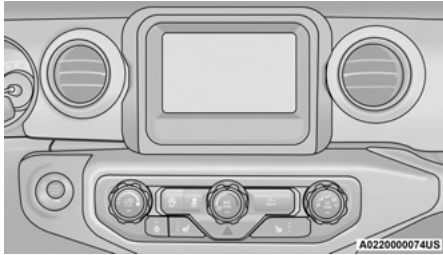

Uconnect 4 With 7-inch Display Manual Climate Controls



Uconnect 3 With 5-inch Display Manual Climate Controls

### MAX A/C Setting — If Equipped



Set the temperature control knob to the MAX A/C setting to change the current setting to the coldest output of air.

Moving the temperature control knob away from the MAX A/C setting causes the MAX A/C operation to exit.

### A/C Button



Push the A/C button to engage the Air Conditioning (A/C). The A/C indicator illuminates when A/C is on.

### NOTE:

- For Manual Climate Controls, if the system is in Mix, Floor or Defrost Mode, the A/C can be turned off, but the A/C system shall remain active to prevent fogging of the windows.
- If fog or mist appears on the windshield or side glass, select Defrost mode, and increase blower speed if needed.
- If your air conditioning performance seems lower than expected, check the front of the A/C condenser (located in front of the radiator), for an accumulation of dirt or insects. Clean with a gentle water spray from the front of the radiator and through the condenser.

### Recirculation Button



Push the recirculation button on the faceplate to change the system between recirculation mode and outside air mode.

The Recirculation indicator and the A/C indicator (if equipped) illuminate when the Recirculation button is pressed. Recirculation can be used when outside conditions such as smoke, odors, dust, or high humidity are present.

Recirculation can be used in all modes except for Defrost. Recirculation may be unavailable if conditions exist that could create fogging on the inside of the windshield. The A/C can be deselected manually without disturbing the mode control selection. Continuous use of the Recirculation mode may make the inside air stuffy and window fogging may occur. Extended use of this mode is not recommended.

On systems with Manual Climate Controls (if equipped), the Recirculation mode is not allowed in Defrost mode to improve window clearing operation. Recirculation is disabled automatically if this mode is selected. Attempting to use Recirculation while in this mode causes the LED in the control button to blink and then turns off.

## Front Defrost Setting



Turn the Mode Control knob to the Front Defrost mode setting. Air comes from the windshield and side window demist outlets. When the Defrost button is selected, the blower level may increase. Use Defrost mode with maximum temperature settings for best windshield and side window defrosting and defogging.

## Rear Defrost Button



Push and release the Rear Defrost Control button to turn on the rear window defroster and the heated outside mirrors (if equipped). The Rear Defrost indicator illuminates when the rear window defroster is on. The rear window defroster automatically turns off after 10 minutes.

### CAUTION!

Failure to follow these cautions can cause damage to the heating elements:

- Use care when washing the inside of the rear window. Do not use abrasive window cleaners on the interior surface of the window. Use a soft cloth and a mild washing solution, wiping parallel to the heating elements. Labels can be peeled off after soaking with warm water.

*(Continued)*

### CAUTION!

- Do not use scrapers, sharp instruments, or abrasive window cleaners on the interior surface of the window.
- Keep all objects a safe distance from the window.

## Temperature Control

Temperature Control regulates the temperature of the air forced through the climate system.



The temperature increases as you turn the temperature control knob clockwise.



The temperature decreases as you turn the temperature control knob counterclockwise.

### Heater Only

Turning the temperature control knob clockwise increases the heating temperature and turning the temperature control knob counterclockwise decreases the heating temperature.

### NOTE:

The numbers within the temperature display will only appear if your vehicle is equipped with an Automatic Climate Control system.

## Blower Control



Blower Control regulates the amount of air forced through the climate system. There are seven blower speeds available. The blower speeds increase as you turn the blower control knob clockwise from the lowest blower setting. The blower speed decreases as you turn the blower control knob counterclockwise.

## Mode Control



Turn the mode control knob to adjust airflow distribution. The airflow distribution mode can be adjusted so air comes from the instrument panel outlets, floor outlets, defrost outlets and demist outlets.

## Panel Mode



Air comes from the outlets in the instrument panel. Each of these outlets can be individually adjusted to direct the flow of air. The air vanes of the center outlets and outboard outlets can be moved up and down or side to side to regulate airflow direction. There is a shut-off wheel located below the air vanes to shut off or adjust the amount of airflow from these outlets.

## Bi-Level Mode



Air comes from the instrument panel outlets and floor outlets. A slight amount of air is directed through the defrost and side window demister outlets.

### NOTE:

Bi-Level mode is designed under comfort conditions to provide cooler air out of the panel outlets and warmer air from the floor outlets.

## Floor Mode



Air comes from the floor outlets. A slight amount of air is directed through the defrost and side window demister outlets.

## Mix Mode



Air is directed through the floor, defrost, and side window demister outlets. This setting works best in cold or snowy conditions that require extra heat to the windshield. This setting is good for maintaining comfort while reducing moisture on the windshield.

## Climate Control OFF



To turn the Climate Controls off, turn the blower control knob to the OFF (O) position.

## AUTOMATIC TEMPERATURE CONTROL (ATC) — IF EQUIPPED

### Automatic Operation

1. Push the AUTO button on the faceplate, or the AUTO button on the touchscreen on the Automatic Temperature Control (ATC) Panel.
2. Next, adjust the temperature that you would like the system to maintain by adjusting the driver and passenger temperature control buttons. Once the desired temperature is displayed, the system will achieve and automatically maintain that comfort level.
3. When the system is set up for your comfort level, it is not necessary to change the settings. You will experience the greatest efficiency by simply allowing the system to function automatically.

### NOTE:

- It is not necessary to move the temperature settings for cold or hot vehicles. The system automatically adjusts the temperature, mode, and blower speed to provide comfort as quickly as possible.
- The temperature can be displayed in US or Metric units by selecting the US/Metric customer-programmable feature within Uconnect Settings → page 207.

To provide you with maximum comfort in the Automatic mode during cold start-ups, the blower fan will remain on low until the engine warms up. The blower will increase in speed and transition into Auto mode.

### Manual Operation Override

This system offers a full complement of manual override features. The AUTO symbol in the front ATC display will be turned off when the system is being used in the manual mode.

## CLIMATE VOICE COMMANDS

Adjust vehicle temperatures hands-free and keep everyone comfortable while you keep moving ahead.

Push the VR button on the steering wheel. After the beep, say one of the following commands:

- “Set the driver temperature to 70 degrees”
- “Set the passenger temperature to 70 degrees”

**Did You Know:** Voice Command for Climate may only be used to adjust the interior temperature of your vehicle. Voice Command will not work to adjust the heated seats or steering wheel if equipped.

## OPERATING TIPS

Refer to the chart at the end of this section for suggested control settings for various weather conditions.

### Summer Operation

The engine cooling system must be protected with a high-quality antifreeze coolant to provide proper corrosion protection and to protect against engine overheating. OAT coolant (conforming to MS.90032) is recommended.

### Winter Operation

To ensure the best possible heater and defroster performance, make sure the engine cooling system is functioning properly and the proper amount, type, and concentration of coolant is used. Use of the Air Recirculation mode during Winter months is not recommended, because it may cause window fogging.

### Vacation/Storage

For information on maintaining the Climate Control system when the vehicle is being stored for an extended period of time, see [☞](#) page 407.

### Window Fogging

Vehicle windows tend to fog on the inside in mild, rainy, and/or humid weather. To clear the windows, select Defrost or Mix mode and increase the front blower speed. Do not use the Recirculation mode without A/C for long periods, as fogging may occur.

### Outside Air Intake

Make sure the air intake, located directly in front of the windshield, is free of obstructions, such as leaves. Leaves collected in the air intake may reduce airflow, and if they enter the plenum, they could plug the water drains. In Winter months, make sure the air intake is clear of ice, slush, and snow.

### Cabin Air Filter







The climate control system filters out dust and pollen from the air. Contact an authorized dealer to service your cabin air filter, and to have it replaced when needed.

### Stop/Start System — If Equipped

While in an Autostop, the Climate Control system may automatically adjust airflow to maintain cabin comfort. Customer settings will be maintained upon return to an engine running condition.

## Operating Tips Chart

The following chart is for Manual Override Operation:

WEATHER	CONTROL SETTINGS
Hot Weather And Vehicle Interior Is Very Hot	Set the mode control to  (Panel Mode), <sup>A/C</sup> (A/C) on, and blower on high. Roll down the windows for a minute to flush out the hot air. Adjust the controls as needed to achieve comfort.
Warm Weather	Turn <sup>A/C</sup> (A/C) on and set the mode control to  (Panel Mode).
Cool Sunny	Operate in  (Bi-Level Mode).
Cool & Humid Conditions	Set the mode control to  (Floor Mode) and turn <sup>A/C</sup> (A/C) on to keep windows clear.
Cold Weather	Set the mode control to  (Floor Mode). If windshield fogging starts to occur, move the control to  (Mix Mode).

## INTERIOR STORAGE AND EQUIPMENT

### STORAGE

#### Glove Compartment

The glove compartment is located on the passenger side of the instrument panel.

To open the glove compartment, pull the release handle.

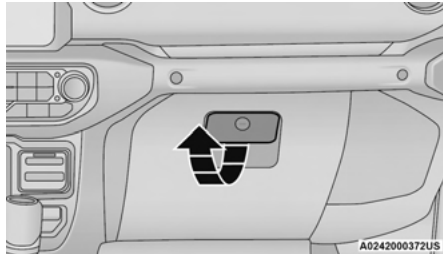

**Glove Compartment**

#### WARNING!

Do not operate this vehicle with a glove compartment in the open position. Driving with the glove compartment open may result in injury in a collision.

#### Console Storage Compartment

The center console has both an upper and lower storage compartment.

To open the upper storage compartment, lift the top latch. To access the lower storage compartment, lift the bottom latch.

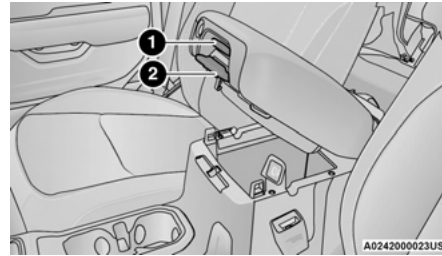

**Console Storage Latches**

- 1 – Upper Compartment Latch
- 2 – Lower Compartment Latch

#### Rear Storage Compartment — If Equipped

The rear cargo area storage compartment is located underneath the load floor.

To access the storage compartment, lift up on the cargo strap at the rear of the cargo area.

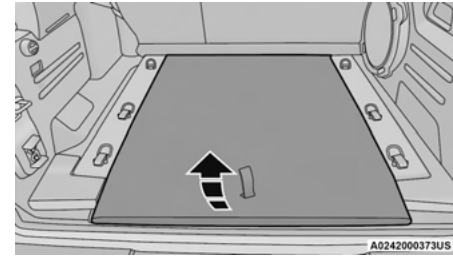

**Rear Storage Cover**

#### USB/AUX CONTROL

The Media Hub is located on the instrument panel, below the climate controls. Behind the media hub access door, the Media Hub contains one AUX port, a Type C USB port and one standard USB port. Both USB ports allow you to play music from MP3 players, smartphones or USB devices through the vehicle's sound system.

Plugging in a smartphone device to a USB port may activate Android Auto™ or Apple CarPlay® features, if equipped. For further information, refer to Android Auto™ or Apple Carplay® ↪ page 250 or in the Owner's Manual Supplement.

The Smart Charging USB ports provide power to your device up to an hour after the vehicle is turned off.

#### NOTE:

- Once a device is connected to the USB port, it will begin charging and is ready for use with the system. Type C and Type A charge-only USB ports can be used at the same time but cannot be used simultaneously while playing media. When both Type C and Type A charge-only USB ports are in use they will be charged at a reduced rate.
- Both ports share a single data connection. The user cannot switch between Type A or Type C.

For example, if a device is plugged into the Type A USB port and another device is plugged into the Type C USB port, a message will appear and allow you to select which device to use.

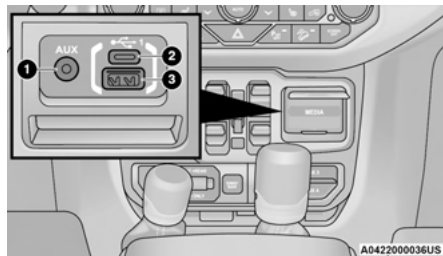

**Media Hub**

- 1 – AUX Port
- 2 – Type C USB Port
- 3 – Type A USB Port

Located inside the center console, a second USB port allows you to play music from USB devices through your vehicle's sound system.

Third and fourth USB ports (if equipped) are located behind the center console, above the power inverter. Both ports are charge only.

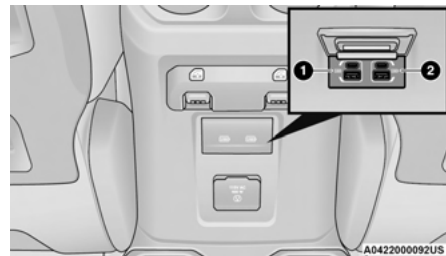

**USB On The Back Of The Center Console**

- 1 – Type C And Standard Charge Only USB Ports
- 2 – Type C And Standard Charge Only USB Ports

When a new device or smartphone is plugged into the USB ports, the following message may display depending on the device being utilized:

- “A new device is now connected. Previous connection was lost”.
- “(Phone Name) now connected. Previous connection was lost”.
- “Another device is in use through the same USB port. Please disconnect the first device to use the second device”.



**NOTE:**

Charge unsupported devices with the Charge Only USB ports. If an unsupported device is plugged into a Media USB port, a message will display on the touchscreen that the device is not supported by the system.

**WARNING!**

Do not plug in or remove the external device while driving. Failure to follow this warning could result in a collision.

**POWER OUTLETS**

There are two 12 Volt (13 Amp) auxiliary power outlets that can provide power for accessories designed for use with the standard power outlet adapters.

The front power outlet is located in the center of the instrument panel below the climate controls, and is powered from the ignition switch. Power is available when the ignition switch is in the ON/RUN or ACC position.

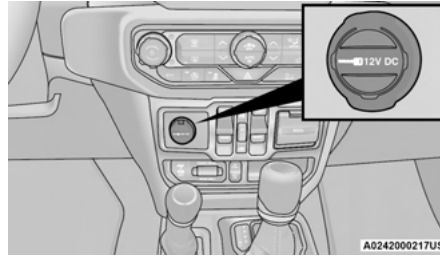
**Front Power Outlet**

On vehicles equipped with a rear subwoofer, there is a second power outlet located in the rear cargo area and is powered directly from the vehicle's battery.

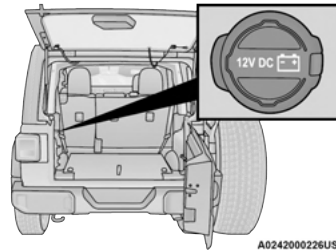
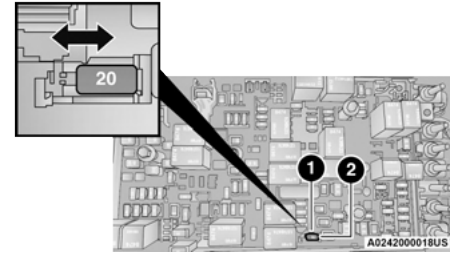
**Rear Cargo Power Outlet****Power Outlets Fuse Locations**

- 1 — F43 Fuse 20A Yellow Rear Power Outlet (battery powered at all times)
- 2 — F45 Fuse 20A Yellow Rear Power Outlet (powered when the ignition switch is in the ON/RUN or ACC position)

**WARNING!**

To avoid serious injury or death:

- Do not insert any objects into the receptacles.
- Do not touch with wet hands.
- Close the lid when not in use.
- If this outlet is mishandled, it may cause an electric shock and failure.

**CAUTION!**

- Do not exceed the maximum power of 160 Watts (13 Amps) at 12 Volts. If the 160 Watt (13 Amp) power rating is exceeded, the fuse protecting the system will need to be replaced.
- Power outlets are designed for accessory plugs only. Do not insert any other object in the power outlets as this will damage the outlet and blow the fuse. Improper use of the power outlet can cause damage not covered by your New Vehicle Limited Warranty.
- Many accessories that can be plugged in draw power from the vehicle's battery, even when not in use (i.e., cellular phones, etc.). Eventually, if plugged in long enough, the vehicle's battery will discharge sufficiently to degrade battery life and/or prevent the engine from starting.
- Accessories that draw higher power (i.e., coolers, vacuum cleaners, lights, etc.), will degrade the battery even more quickly. Only use these intermittently and with greater caution.

*(Continued)***CAUTION!**

- After the use of high power draw accessories, or long periods of the vehicle not being started (with accessories still plugged in), the vehicle must be driven a sufficient length of time to allow the alternator to recharge the vehicle's battery.
- Power outlets are designed for accessory plugs only. Do not hang any type of accessory or accessory bracket from the plug. Improper use of the power outlet can cause damage.

**POWER INVERTER — IF EQUIPPED**

There is a 115 Volt, 150 Watt inverter outlet located on the back of the center console to convert DC current to AC current.

This outlet can power cellular phones, electronics and other low power devices requiring power up to 150 Watts. Certain video game consoles exceed this power limit, as will most power tools.

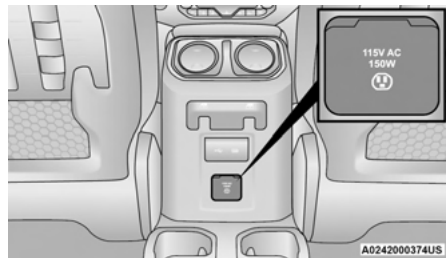
**Power Inverter**

The power inverter is designed with built-in overload protection. If the power rating of 150 Watts is exceeded, the power inverter automatically shuts down. Once the electrical device has been removed from the outlet, the inverter should automatically reset. If the power rating exceeds approximately 170 Watts, the power inverter may have to be reset manually.

**WARNING!**

To avoid serious injury or death:

- Do not insert any objects into the receptacles.
- Do not touch with wet hands.
- Close the lid when not in use.
- If this outlet is mishandled, it may cause an electric shock and failure.

## AUXILIARY SWITCHES — IF EQUIPPED

Four auxiliary switches located in the lower switch bank of the instrument panel can be used to power various electrical devices. You have the ability to configure the functionality of the auxiliary switches via the Uconnect Settings ↻ page 207.

All switches can be configured as follows:

- **Switch type operation:** Latching or Momentary
- **Power source:** Battery or Ignition
- **Ability to hold last state across key cycles:** On or Off

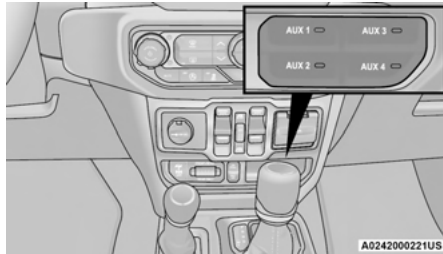

**Auxiliary Switches**

### NOTE:

Holding last state conditions are met when switch type is set to latching and power source is set to ignition.

The auxiliary switches manage the relays that power four blunt cut wires. These wires are located under the instrument panel in the passenger compartment and under the hood to the right, near the battery.

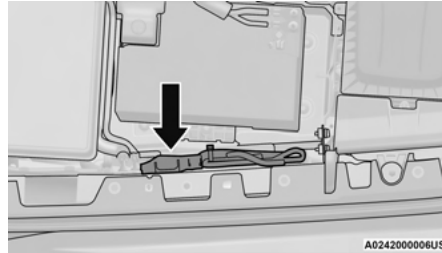

**Auxiliary Switch Connections – Under Hood**

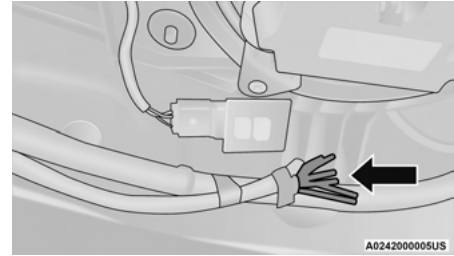

**Auxiliary Switch Connections – Under Instrument Panel**

In addition to the four auxiliary switch wires, a fused battery wire and ignition wire are also located in the interior, in the passenger side under the instrument panel.

A kit of splices and heat shrink tubing are provided with the auxiliary switches to aid in the connection/installation of your electrical devices.

**Wire Color Chart**

<b>Circuit Function</b>	<b>Fuse</b>	<b>Wire Color</b>	<b>Locations</b>
Aux Switch 1	F93 - 40 Amp	Beige/Pink	Interior (passenger side under instrument panel) & Underhood (right side near battery)
Aux Switch 2	F92 - 40 Amp	Green/Pink	Interior (passenger side under instrument panel) & Underhood (right side near battery)
Aux Switch 3	F103 - 15 Amp	Orange/Pink	Interior (passenger side under instrument panel) & Underhood (right side near battery)
Aux Switch 4	F108 - 15 Amp	Dark Blue/Pink	Interior (passenger side under instrument panel) & Underhood (right side near battery)
Battery	F72 - 10 Amp	Red/White	Interior (passenger side under instrument panel)
Ignition	F50 - 10 Amp	Pink/Orange	Interior (passenger side under instrument panel)

## POWER WINDOWS — IF EQUIPPED

The power window switches are located on the instrument panel below the climate controls. Push the switch downward to open the window and upward to close the window.

The top left switch controls the left front window and the top right switch controls the right front window.

### WARNING!

Never leave children unattended in a vehicle, and do not let children play with power windows. Do not leave the key fob in or near the vehicle, or in a location accessible to children. Occupants, particularly unattended children, can become entrapped by the windows while operating the power window switches. Such entrapment may result in serious injury or death.

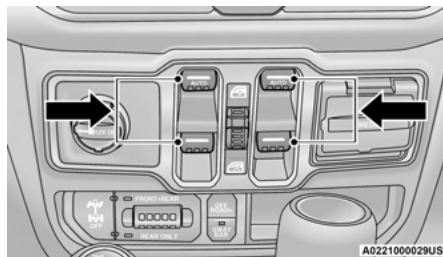

**Power Window Switches**

To open the window part way (manually), push the window switch down briefly and release.

### NOTE:

The power window switches will remain active for up to 10 minutes after ignition is placed in the OFF position. Opening either front door will cancel this feature.

### Four-Door Models

The lower left switch controls the left rear passenger window, and the lower right switch controls the right rear passenger window.

### NOTE:

There are window switches located on the rear of the center console for the rear passenger windows in the four-door model.

## AUTO-DOWN FEATURE

The driver door power and the passenger door power window switches have an Auto-Down feature. Push the window switch down to the second detent and release, and the window will go down automatically.

To stop the window from going all the way down during the Auto-Down operation, pull up on the switch briefly.

### WARNING!

There is no anti-pinch protection when the window is almost closed. Be sure to clear all objects from the window before closing.

## WINDOW LOCKOUT SWITCH

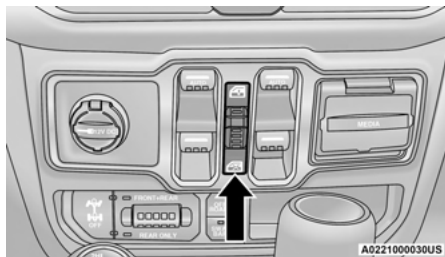

Window Lockout Switch

The window lockout switch allows you to disable the window controls on the rear passenger doors. To disable the window controls, rotate the switch downward. To enable the window controls, rotate the switch upward.

## WIND BUFFETING

Wind buffeting can be described as the perception of pressure on the ears or a helicopter-type sound in the ears. Your vehicle may exhibit wind buffeting with the windows down in certain open or partially open positions. This is a normal occurrence and can be minimized by adjusting the window opening.

## WRANGLER TOPS

### PROVIDED TOOLS

For your convenience, a tool kit is provided with your vehicle located in the center console. This kit includes the necessary tools required for the operations described in the following sections. All pieces fit into the ratchet for easy use.

#### NOTE:

**The soft top and the hard top are to be used independently.** Your vehicle warranty will not cover damage resulting from both tops being installed at the same time.

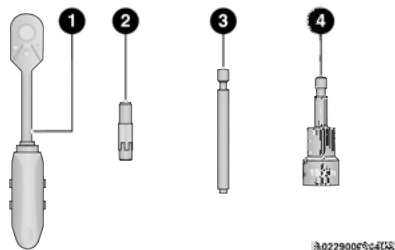

Provided Tools

- 1 – Ratchet
- 2 – #T50 Torx Head Driver
- 3 – #T40 Torx Head Driver
- 4 – 15 mm Socket

If your vehicle is equipped with a Dual Top (four door models only), the soft top system will be provided in a separate box located in the rear of the vehicle for shipping purposes only.

## LOWERING THE SOFT TOP INTO SUNRIDER® POSITION

Use this QR code to access your digital experience.



### WARNING!

- The fabric quarter windows and fabric top are designed only for protection against the elements. Do not rely on them to contain occupants within the vehicle or to protect against injury during an accident. Remember, always wear seat belts.
- Make sure hands and fingers are clear of all pinch points when installing and removing the soft tops. The lift assist mechanism and side bows may cause serious injury if fingers or hands get caught in between.

**CAUTION!**

The soft top is not designed to carry any additional loads such as roof racks, spare tires, building, hunting, or camping supplies, and/or luggage, etc. Also, it was not designed as a structural member of the vehicle and, thus, cannot properly carry any additional loads other than environmental (rain, snow, etc.).

If the temperature is below 72°F (24°C) and/or the top has been folded down for a period of time, the top will appear to have shrunk when you raise it, making it difficult to put up. This is caused by a natural contraction of the vinyl or acrylic materials of the fabric top.

Place the vehicle in a warm area. Pull steadily on the top fabric. The vinyl will stretch back to its original size and the top can then be installed. **If the temperature is 41°F (5°C) or below, do not attempt to put the top down or roll the rear or side curtains.**

**CAUTION!**

- Do not run a fabric top through an automatic car wash. Window scratches and wax buildup may result.
- Do not lower the top when the temperature is below 41°F (5°C). Damage to the top may result.
- Do not move your vehicle until the top has been either fully attached to the windshield frame, or fully lowered.
- Do not fully lower the top with the windows installed. Window and top damage may occur.
- For important information on cleaning and caring for your vehicle's fabric top  
 ⇨ page 409.
- Do not use any tools (screwdrivers, etc.) to pry or force any of the clamps, clips, or retainers securing the soft top. Do not force or pry the soft top framework when opening or closing. Damage to the top may result.

(Continued)

**CAUTION!**

Failure to follow these cautions may cause interior water damage, stains or mildew on the top material:

- It is recommended that the top be free of water prior to opening it. Operating the top, opening a door or lowering a window while the top is wet may allow water to drip into the vehicle's interior.
- Careless handling and storage of the soft top may damage the seals, causing water to leak into the vehicle's interior.
- The soft top must be positioned properly to ensure sealing. Improper installation can cause water to leak into the vehicle's interior.

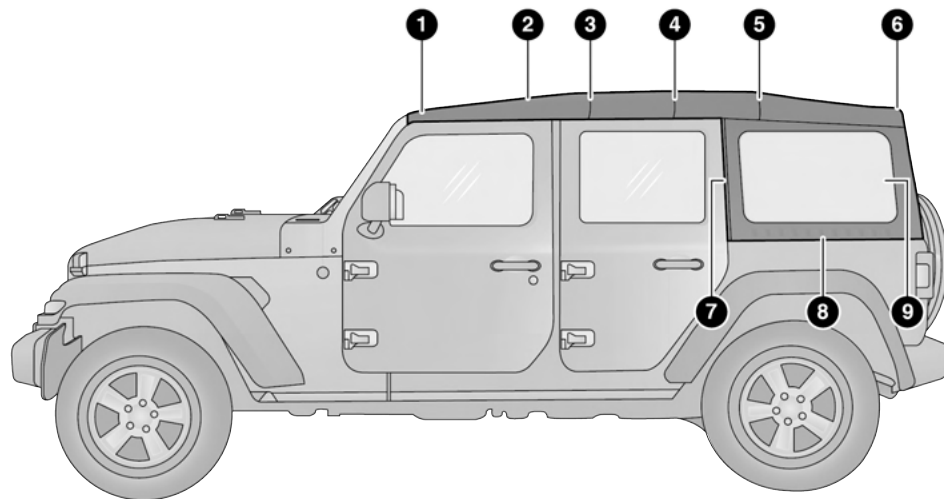

A0233000016US

#### Four Door Side View Components

- 1 – #1 Bow
- 2 – #2 Bow
- 3 – #3 Bow
- 4 – #4 Bow
- 5 – #5 Bow

- 6 – #6 Bow
- 7 – Front Window Retainer
- 8 – Lower Window Retainer
- 9 – Rear Quarter Window



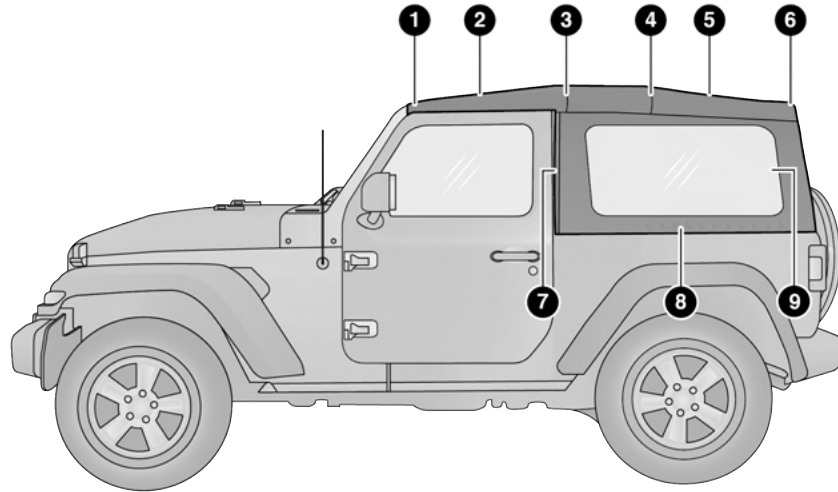

A0232000052US

### Two Door Side View Components

- 1 – #1 Bow
- 2 – #2 Bow
- 3 – #3 Bow
- 4 – #4 Bow
- 5 – #5 Bow

- 6 – #6 Bow
- 7 – Front Window Retainer
- 8 – Lower Window Retainer
- 9 – Rear Quarter Window

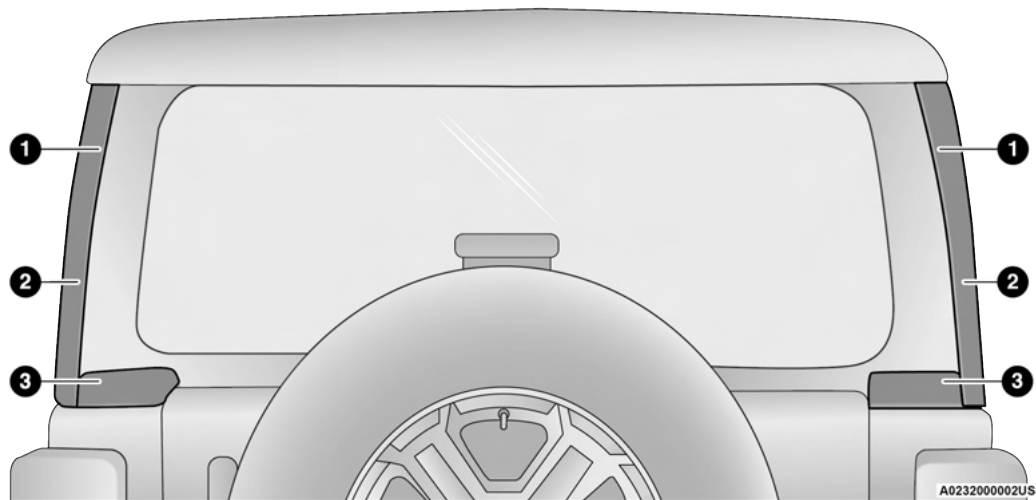

**Two And Four Door Rear Components**

- 1 – Rear Window Retainer Attachment Points
  - 2 – Quarter Window Pillars
  - 3 – Swing Gate Bar Retainers
-

**NOTE:**

- All lowering and raising the soft top instructions are applicable to both two and four door model vehicles.
- Images shown are of four door models, and appearance of two door model components may differ.

The following options are available to you when lowering your vehicle's soft top:

- Sunrider® position with rear and quarter windows installed
- Sunrider® position with rear and quarter panels removed
- Sunrider® position with rear window installed and quarter panels removed
- Fully lowered position with rear and quarter windows removed

Both quarter windows should be removed and installed together.

**Lowering The Soft Top Into Sunrider® Position**

1. Fold both sun visors forward against the windshield.
2. Release the header latches from the crossbar by pulling the handle downward. Make sure the hook is disengaged from its receiver.

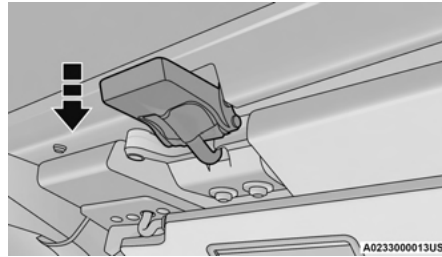
**Step Two**

3. From both the left and right sides, lift up on the #1 Bow of the soft top to start the operation.

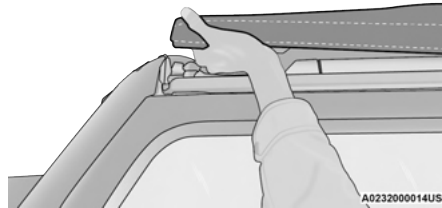
**Step Three**

4. Move to the side of the vehicle and use the side link to fold the soft top rearward into the Sunrider® position.

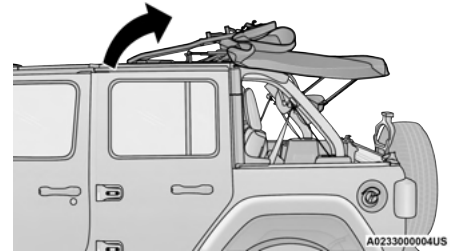
**Step Four****NOTE:**

If leaving the soft top in the Sunrider® position, secure the top by using the two hook-and-loop fasteners provided in the center console.

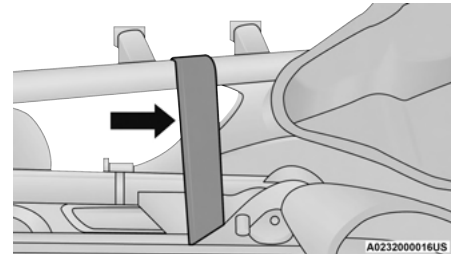
**Step Four**

**NOTE:**

- The vehicle can be driven in the Sunrider® position with the rear window and quarter panel assemblies fully installed or completely removed.
- The rear window and rear quarter windows must be removed before fully lowering the soft top to prevent damage to the top. Clean the side and rear windows before removal to assist in preventing scratching during removal of the soft top. If the plastic retainers are difficult to operate due to road dust, etc., clean them with a mild soap solution and a small brush. Cleaning products are available through an authorized dealer.

**Removing The Soft Top Windows****NOTE:**

Before fully lowering the soft top, the rear window and rear quarter windows **must** be removed.

**Remove The Rear Window:**

1. With the swing gate open, remove the rear window's plastic retainers from the lower right and left corners.

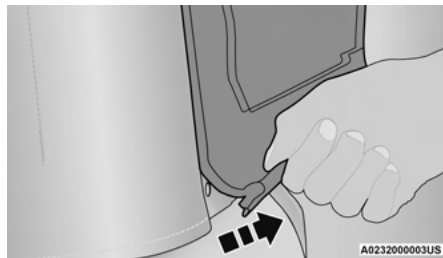
**Step One**

2. Grab the swing gate bar, rotate it outward and upward releasing it from both the right and left retainers.

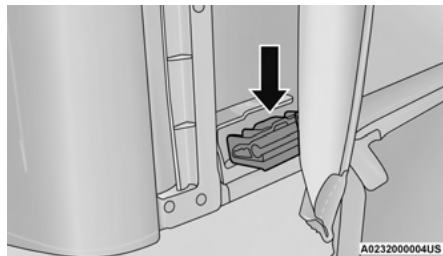
**Step Two (Left Side Shown)**

3. While holding the window in place, slide the swing gate bar to the left separating it from the rear window. Store in soft window bag (if equipped), or a safe location.

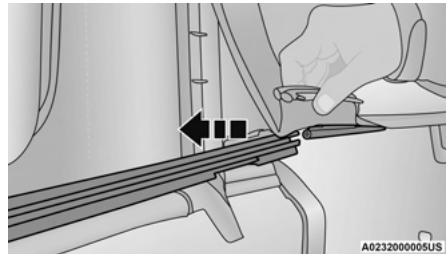
**Step Three**

4. Remove the plastic retainers from both quarter window pillars.

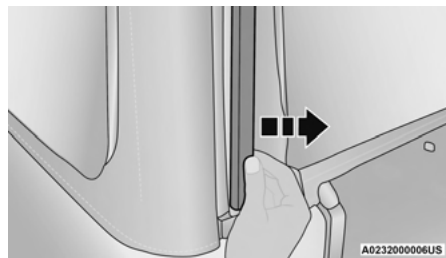
**Step Four**

- While keeping the rear window level, slide to the left until it is completely separate from its retainer. **Do not pull downward while removing the rear window. Damage to the retainer could result.**

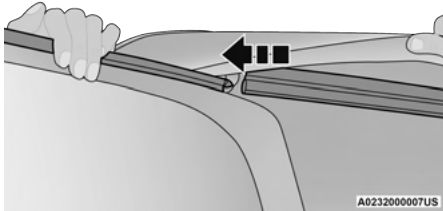

Step Five

#### Remove The Right And Left Quarter Windows:

- Through the rear opening, push the bottom corner outward and release tab from the bottom of the window pillar.

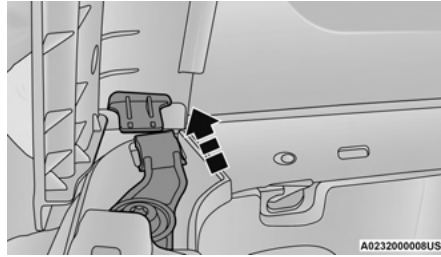

Step One

- Undo the hook-and-loop fastener located at the upper front corner of each quarter window.

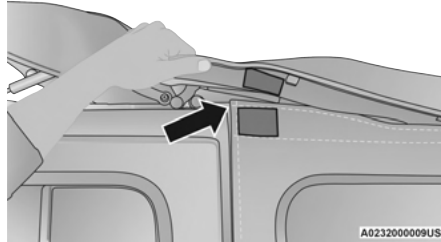

Step Two

- Starting at the rear of the vehicle, remove plastic retainer from along the bottom of the window moving toward the front of the vehicle.

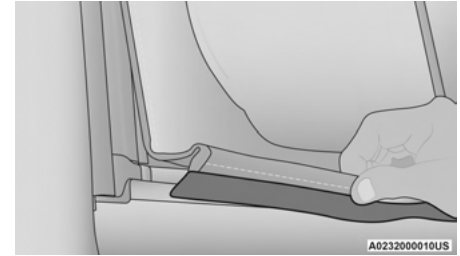

Step Three

- Remove plastic retainer from the bottom to the top of the front window.

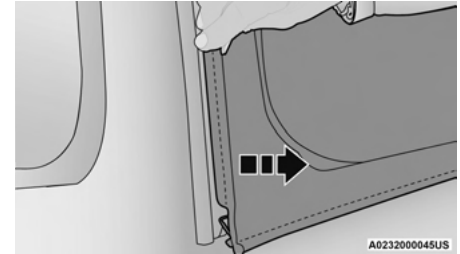

Step Four

5. While keeping the window level, slide rearward until it is completely separate from its retainer. **Do not pull downward while removing the window. Damage to the retainer could result.**

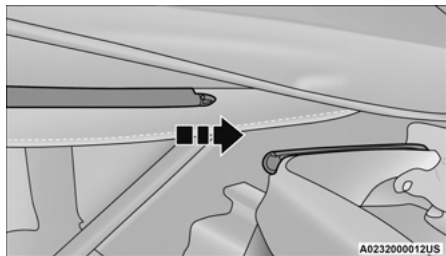

Step Five

6. Store in soft window bag (if equipped) or a safe location.

**NOTE:**

For information on the use of the storage bag, refer to the next section.

### Soft Top Window Storage Bag — If Equipped

To safely store the soft top rear window, and rear quarter windows, proceed as follows:

**NOTE:**

The swing gate bar, once removed from the rear window, **does not** store in the soft window storage bag (if equipped).

1. With the bag opened completely, fold both fabric dividers downward and lay the first quarter window all the way to the right side with the inside of the window facing downward and the window pillar to the outside.

**NOTE:**

The quarter windows are marked “1” and “2” on the inside of the window pillar.

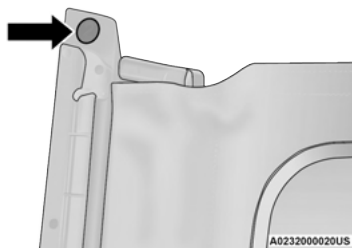

Step One

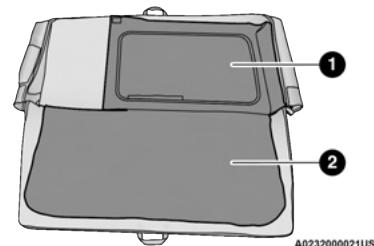

Step One

- 1 — Quarter Window Facing Downward
- 2 — Both Dividers Folded Down

2. Fold the first divider upward, covering the first quarter window.

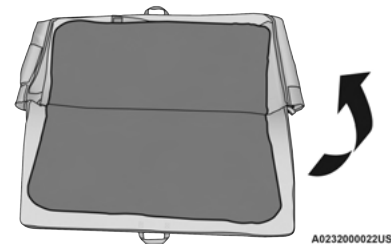

Step Two

3. Lay the second quarter window on top of the first divider all the way to the left side with the inside of the window facing downward and the window pillar to the outside.

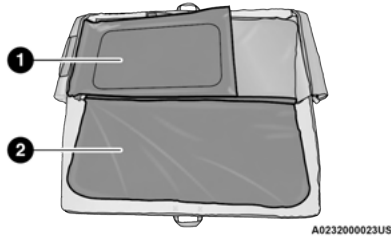
**Step Three**

- 1 – Quarter Window Facing Downward  
2 – Second Divider Folded Down

4. Fold the second divider upward, covering the second quarter window.

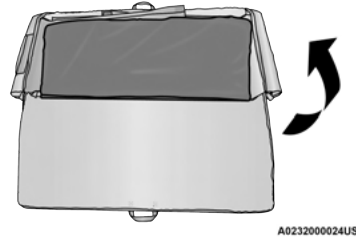
**Step Four**

5. Lay the rear window on top of the second divider.

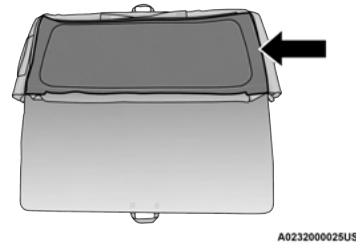
**Step Five**

6. Close the storage bag and store in a safe location.

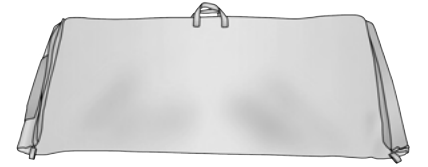
**Step Six**

### Lowering The Soft Top All The Way

1. Remove the rear window and quarter panel windows → page 82.
2. From the Sunrider® position → page 76, remove straps if previously secured and move to the rear of the vehicle.

3. Locate the Sunrider® latch beneath the #6 Bow of the soft top on the left side.

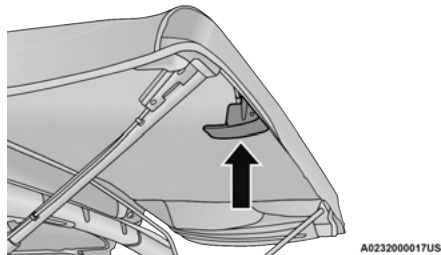

Step Three

4. Pull the latch to release the top, and allow the soft top to slide rearward freely in the guide tracks to the stowed position.

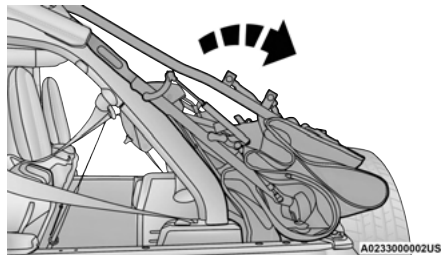

Step Four

<b>CAUTION!</b>
Failure to follow the next steps could result in damage to the Soft Top or vehicle.

5. While pushing downward slightly on the folded soft top, slide the lock lever on the left and right side lift assist mechanisms to the “lock” position.

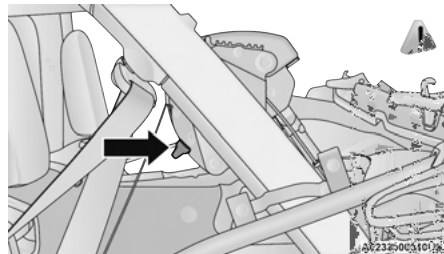

Step Five (Locked Position)

6. Once the lock lever is in the “lock” position, push downward on each side of the folded soft top to ensure it is secure. An audible “click” may be heard.

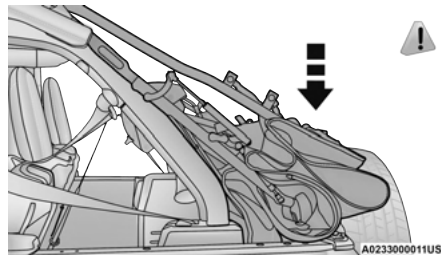

Step Six

**NOTE:**

Secure the top by using the two hook-and-loop fasteners provided in the center console.

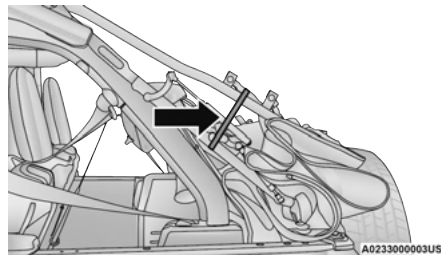

Step Six



## RAISING THE SOFT TOP

Use this QR code to access your digital experience.

### Raising The Soft Top From The Fully Lowered Position

1. From the fully lowered position, remove straps if previously secured.



#### CAUTION!

Failure to follow the next steps could result in damage to the Soft Top or vehicle.

2. While pushing down on the rear of the top, slide the lock lever on the left and right side lift assist mechanisms to the “unlock” position.

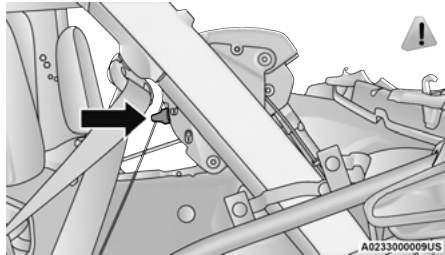

Step Two

3. Push up and forward from the #5 Bow along the guide track until it locks into the Sunrider® position with an audible “click”.

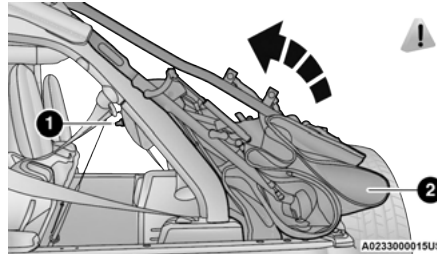

Step Three

- 1 – Unlocked Position  
2 – #5 Bow Location

4. Gently pull rearward on the #6 Bow to ensure the top is locked in the Sunrider® position.
5. Using the side link, lift and push the soft top toward the front of the vehicle manually guiding the top into the closed position.

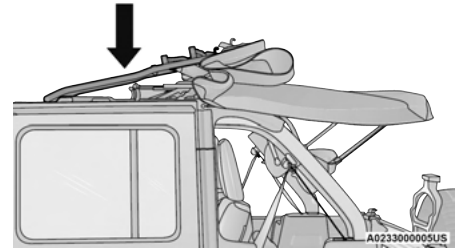

Step Five

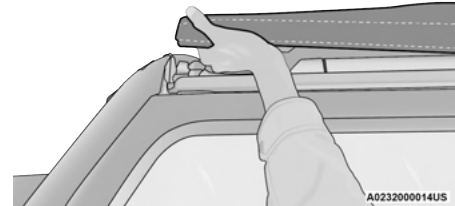

Step Five

- From inside the vehicle, pull the handle on the header latch downward to engage the hook into its receiver. Repeat on the other side.



Step Six

- Pull the handle back upward while squeezing the hook, locking the latch into place.

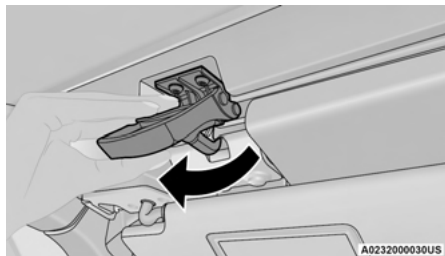

Step Seven

## Installing The Soft Top Windows

### Install The Right And Left Quarter Windows

- From the rear of the vehicle, guide the top of the window into the retainer and slide forward while keeping the window level. Repeat on the other side.

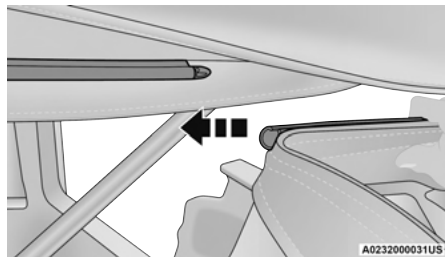

Step One

- Place the top of the quarter window pillar into the top cover, and insert the bottom tab into the clip.

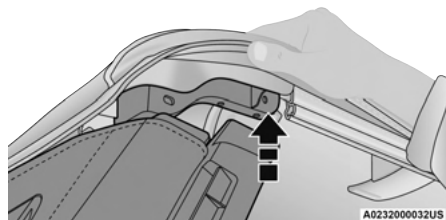

Step Two

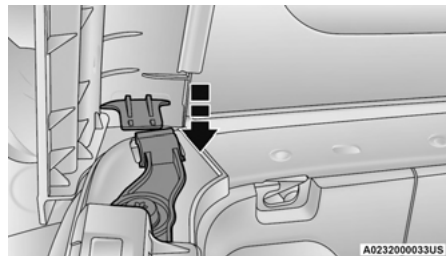

Step Two

### CAUTION!

Failure to follow all Quarter Window Install steps could result in damage to the Soft Top or vehicle.

- Engage the retainers on the front of the windows, ensuring they are fully engaged, followed by the retainers along the bottom of the windows.

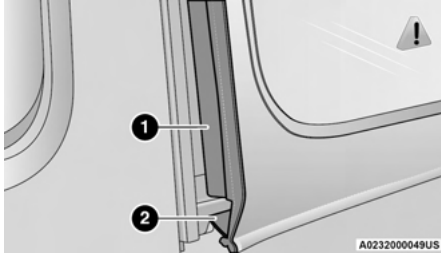

Step Three

- 1 – Retainer At Front Of Quarter Window  
2 – Retainer At Bottom Of Quarter Window

**NOTE:**

It is **critical** that the retainers are fully engaged before the vehicle resumes motion.

- Secure the hook-and-loop fastener at the upper front corner of each quarter window by pressing firmly.

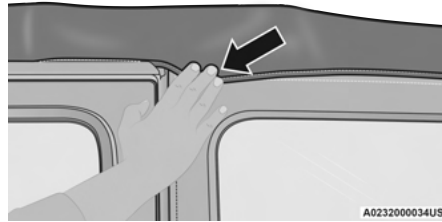

Step Four

**Install The Rear Window**

- Guide the rear window into the retainer from left to right while keeping the window level.

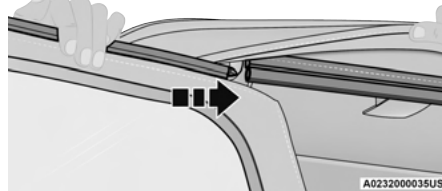

Step One

- Insert the swing gate bar into the retainers at the bottom of the window from left to the right.

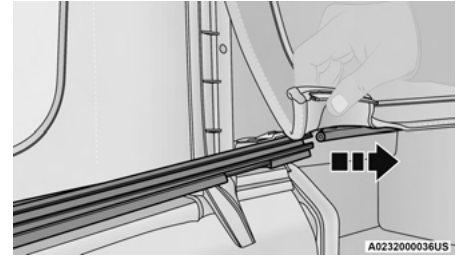

Step Two

- Rotate the swing gate bar into the left and right side retainers.



Step Three

- Line up the rear window to the **right side** quarter window first, and engage the plastic retainers.

- Repeat with the left side quarter window.

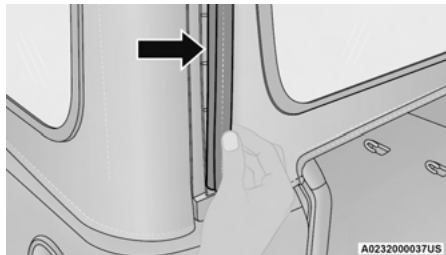

**Step Five**

- Engage the rear window retainers in the lower right and left corners.

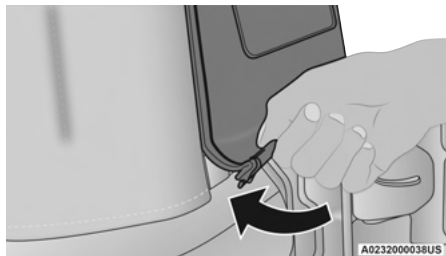

**Step Six**

**NOTE:**

For information on removing your soft top, refer to the next section.

**REMOVING THE SOFT TOP**

Use this QR code to access your digital experience.



- Fully lower the soft top  
→ page 85.

**CAUTION!**

Failure to follow the next steps could result in damage to the Soft Top or vehicle.

- Make sure the lift assist mechanism on both the left and right sides are in the “lock” position, and an audible “click” is heard when pushing down on the #1 bow from each of the lift assist mechanisms before removing.

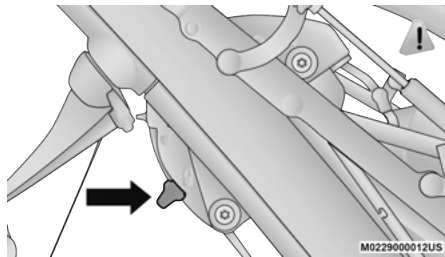

**Step Two**

- Using the provided #40 Torx head driver and ratchet, unscrew the two Torx head screws on each lift assist mechanism, then lift the mechanism up and away from the vehicle.

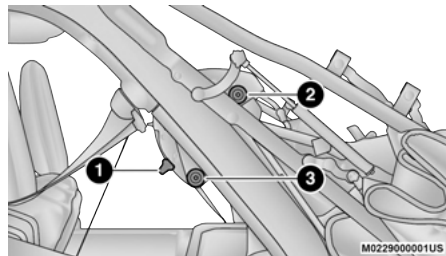

**Step Three**

- 1 – Lock Position
- 2 – Torx Head Screw
- 3 – Torx Head Screw

- Pull the release lever on top of the rail rearward to release the side link from the track.

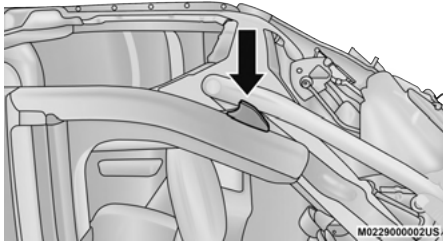

Step Four

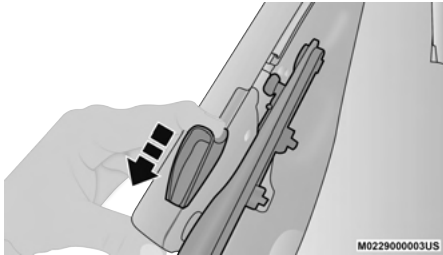

Step Four

- Repeat on the opposite side.
- Utilizing two people, lift the soft top up and away from the vehicle, careful to avoid the

vehicle's sport bar, trim, and tire carrier. Store the soft top in a safe, clean, and dry location.

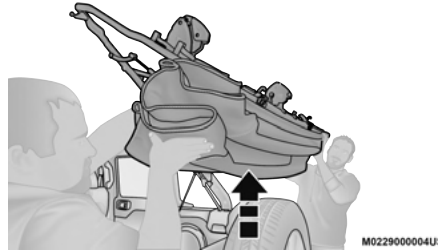

Step Six

- Using the provided #50 Torx head driver and ratchet, unscrew the Torx screw on both rear corners of the vehicle, removing the retainers.

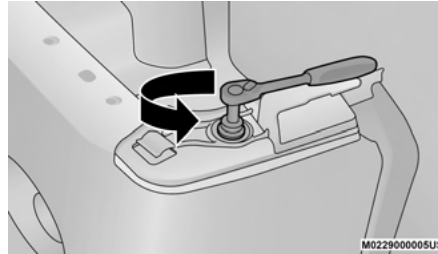

Step Seven

## INSTALLING THE SOFT TOP

- If currently installed, remove the hard top  
➔ page 97.
- Install the door rails, starting with the front, followed by the rear on each side. For instructions and appropriate torque specifications for the door rail Torx screws  
➔ page 107.
- Install the rear retainers on each side of the rear of the vehicle using the provided #50 Torx head driver and ratchet. Refer to the following table for recommended torque specifications.

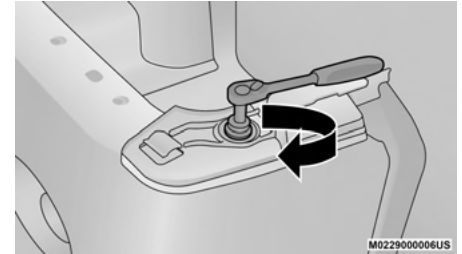

Step Three

### CAUTION!

Do not overtighten Torx screws. Damage to the retainers will occur.

Torque Specification For Torx Screw	Maximum	Minimum
119.5 in-lb	150.5 in-lb	106.2 in-lb
13.5 N-m	17.0 N-m	12.0 N-m

**CAUTION!**

Failure to follow the next steps could result in damage to the Soft Top or vehicle.

- Making sure the lift assist mechanism is in the "lock" position, lift the soft top into the rear of the vehicle with the side links pointing toward the front. Lower the lift assist mechanisms onto its retainers on both sides (on the inside of the sport bar).

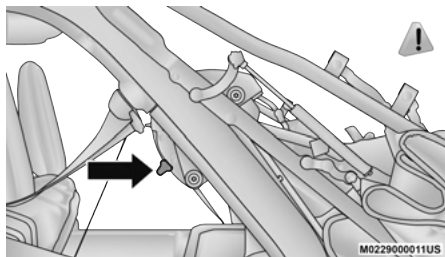
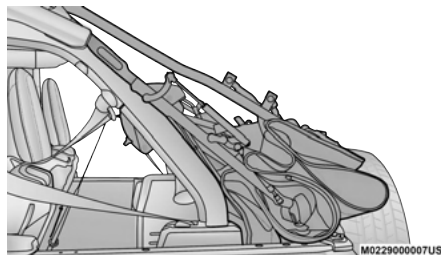
**Step Four****Step Four**

- Using the provided #40 Torx head driver and ratchet, tighten the Torx screws by turning them clockwise. Secure them until they are snug (refer to the following table for recommended torque specifications), being careful not to cross-thread the screws or overtighten. Repeat on the opposite side.

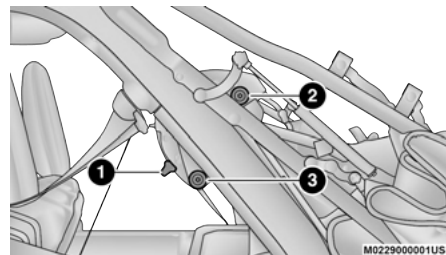
**Step Five**

- Lock Position
- Torx Head Screw
- Torx Head Screw

Torque Specification For Torx Screws	Maximum	Minimum
119.5 in-lb	150.5 in-lb	106.2 in-lb
13.5 N-m	17.0 N-m	12.0 N-m

**CAUTION!**

Do not overtighten the screws. You can strip the screws if they are overtightened.

6. While pulling the release lever on the top of the rail rearward, place the side link into the guide track on the top of the rail then release the lever.

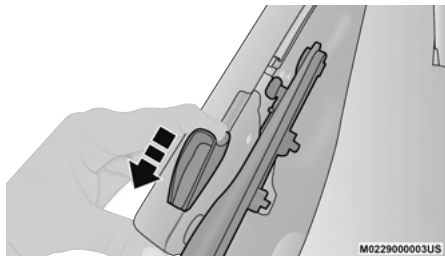

**Step Six**

7. Unsnap and remove the black boot cover. This cover should be discarded. It was intended as a protective cover for shipping only.
8. Raise the soft top ↪ page 87.

**NOTE:**

Be sure the wire harness in the left rear corner is not tangled in the soft top bows before you lift the top.

## HARD TOP FRONT PANEL(S) REMOVAL

Use this QR code to access your digital experience.



**CAUTION!**

- The hard top is not designed to carry any additional loads, such as after-market roof racks, spare tires, building materials, hunting or camping supplies, etc. For optional Mopar® accessory roof racks ↪ page 114.
- Do not move your vehicle until the top has been either fully attached to the front header, sport bar, and body side or fully removed.

*(Continued)*

**CAUTION!**

Failure to follow these cautions may cause interior water damage, stains or mildew:

- It is recommended that the top be free of water prior to panel removal. Removing the top, opening a door or lowering a window while the top is wet may allow water to drip into the vehicle's interior.
- The hard top assembly must be positioned properly to ensure sealing. Improper installation can cause water to leak into the vehicle's interior.
- Careless handling and storage of the removable roof panels may damage the seals, causing water to leak into the vehicle's interior.
- The front panel(s) must be positioned properly to ensure sealing. Improper installation can cause water to leak into the vehicle's interior.

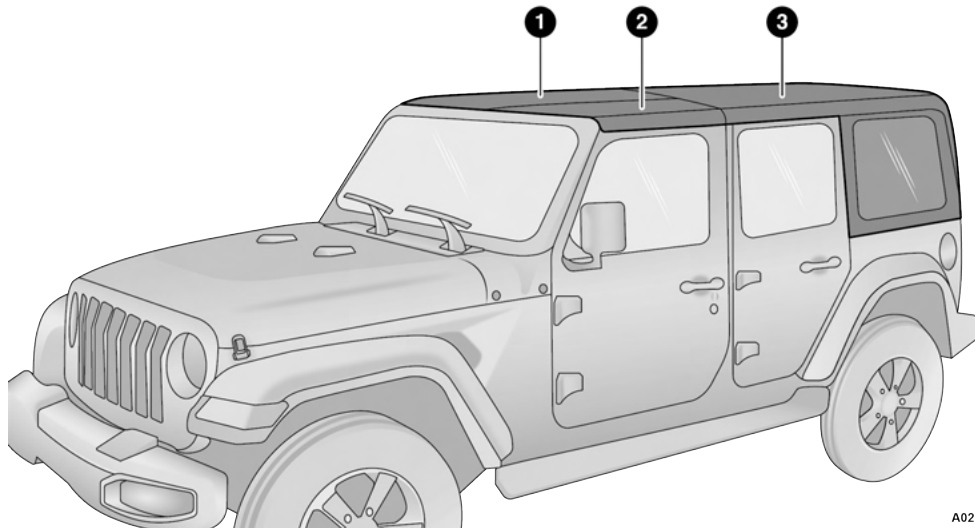

A023000023US

**Four Door Hard Top Components**

- 1 – Right Side Panel
  - 2 – Left Side Panel
  - 3 – Hard Top
-



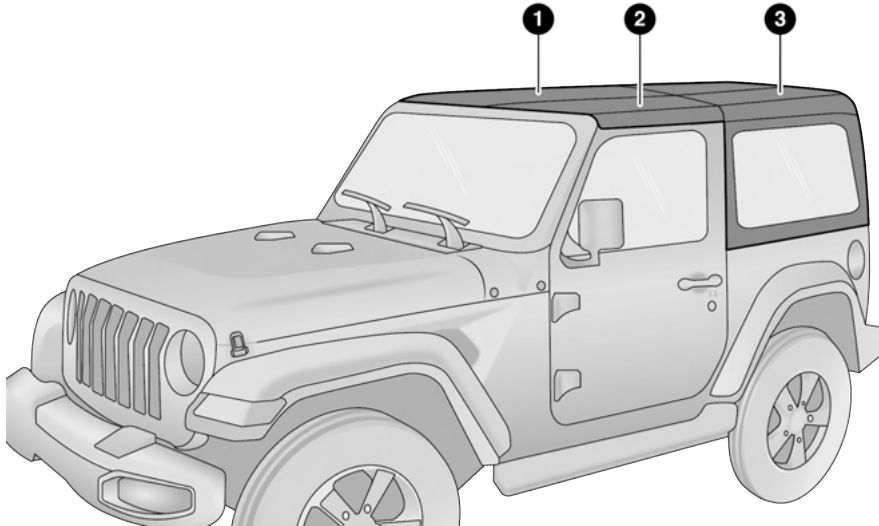

2

A023000025US

**Two Door Hard Top Components**

- 1 – Right Side Panel
- 2 – Left Side Panel
- 3 – Hard Top

**NOTE:**

- All hard top removal and installation instructions are applicable to both two and four door model vehicles.
- Images shown are of four door models, and appearance of two door model components may differ.
- The left side panel must be removed before removing the right side panel.

To remove the hard top front panel(s), proceed as follows:

1. Fold down the sun visor against the windshield.
2. Turn the three L-shaped locks on the left side panel (one at the front, the rear, and outside), unlocking them from the roof.

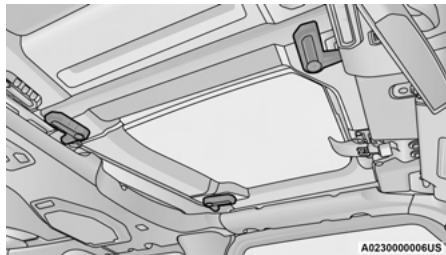
**Step Two**

3. Unlatch the left side header panel latch located at the top of the windshield.

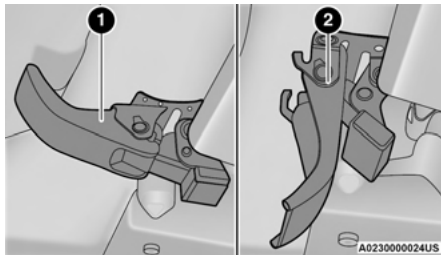
**Step Three**

- 1 – Header Panel Latched  
2 – Unlatched Position

4. Remove the left side panel.
5. Repeat the previous steps to remove the right side panel.

### Hard Top Panel(s) Storage Bag — If Equipped

The Freedom Top panels storage bag allows you to store your hard top panels. The storage bag contains two compartments.

Lay the bag for the Freedom Top panels down so the loops and hooks are facing upward. Unzip the bag and fold back the outer flap.

**NOTE:**

Ensure the front panel latch is closed prior to inserting the panel into the panels bag.

1. Insert the left side hard top panel into the bag with the latches facing upward.
2. Unfold the black panel divider (ensure the divider is lying flat).
3. Insert the right side Freedom Top panel into the bag with the latches facing downward.

**NOTE:**

Ensure the front panel latch is closed prior to inserting the panel into the bag.

4. Unfold the outer flap and zip the hard top bag closed.

**Step Four**

- Lift the Freedom Top bag into the vehicle with the hooks and straps facing the back of the rear seat. Attach the clip at the bottom of the bag to the child restraint anchorage, located at the base of the rear seat.
- Wrap the upper strap around the rear head restraints and loop the strap through the buckle. Pull on the strap to tighten the Freedom Top bag securely against the rear seat.

## HARD TOP FRONT PANEL(S) INSTALLATION

- Open the header latch inside the vehicle, and the three L-shaped locks on each panel.
- Set the right side panel on the windshield frame with the locating pin in the front receiver mounting hole followed by the left side panel, making sure there is no overhang. Also, make sure that the panels are sitting flush with the body.
- Reinstall the panel(s) using the same steps for removal in reverse order.

### NOTE:

To prevent water leaks, the seals and hard top panels should be clear of any dust and debris prior to reinstallation.

## REMOVING THE HARD TOP

- Remove both front panels ⇨ page 93.
- Open both front doors.
- Using the provided #50 Torx head driver and ratchet, remove the two Torx head screws that secure the hard top at the B-pillar (near the top of the front doors).

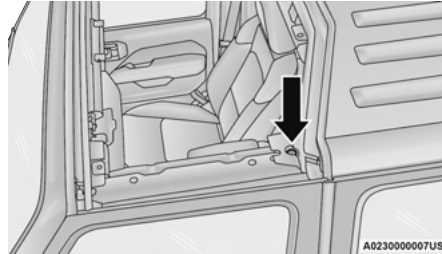

Step Three

- Remove the six Torx head screws that secure the hard top to the vehicle (along the interior bodyside — three screws on each side) using the #50 Torx head driver.

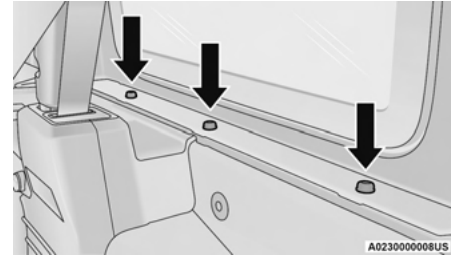

Step Four

- Open the swing gate all the way to ensure clearance of the rear window glass. Lift the rear window glass.

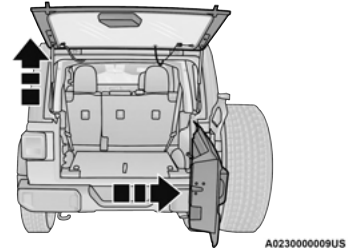

Step Five

6. Locate the wire harness and washer hose on the left rear inside corner of the vehicle.

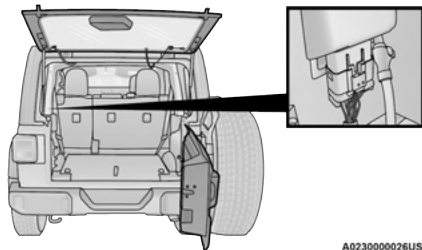

**Step Six**

A0230000026US

7. Release the locking tab by pushing it downward.

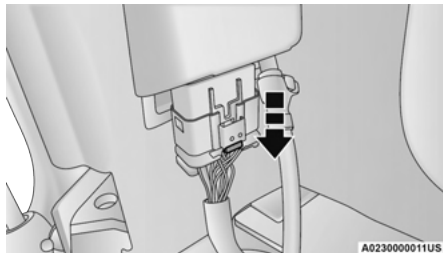

**Step Seven**

A0230000011US

8. To remove the wiring harness, push the tab inward while pulling downward to disconnect.

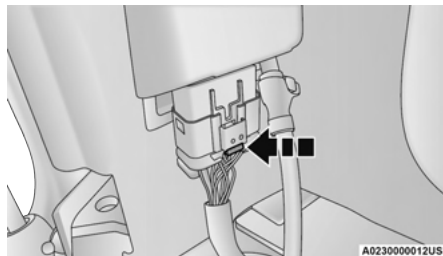

**Step Eight**

A0230000012US



**Step Eight**

A0230000013US

9. To remove the washer hose, push the release button on hose connector, and pull downward.

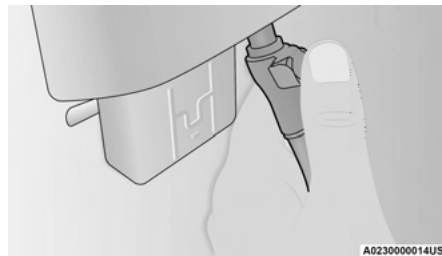

**Step Nine**

A0230000014US

10. Secure the wire harness to the body side by plugging it into the receptacle and reengaging the locking tab.

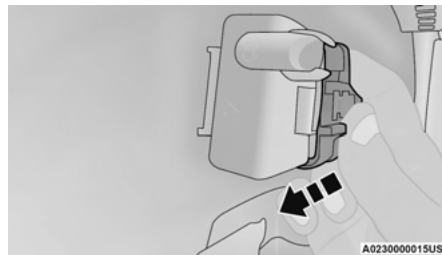

**Step Ten**

A0230000015US

11. Secure the washer hose by snapping it into the top of the body side receptacle.

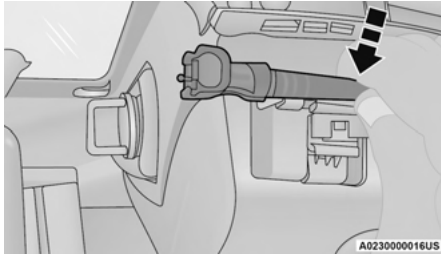

Step Eleven

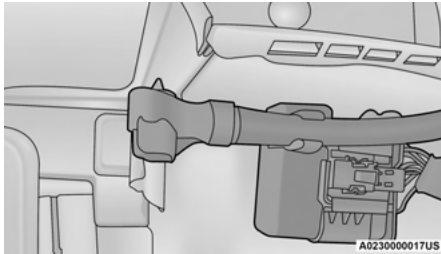

Step Eleven

12. Lower the rear window, and close the swing gate.  
13. Remove the hard top from the vehicle. Place the hard top on a soft surface to prevent damage.

**CAUTION!**

The removal of the rear Hard Top requires four adults, one located on each corner. Failure to follow this caution could damage the Hard Top.

**INSTALLING THE HARD TOP**

If the door frames are installed from soft top usage, they must be removed prior to installation of the hard top. For removal procedures, see ☞ page 106.

To install the hard top, place the hard top on the vehicle while making sure that the top is sitting flush with the body at the sides and check to ensure that there is a uniform gap between the lift glass and hard top. Then follow the removal steps in reverse order.

**NOTE:**

- Inspect the hard top seals for damage and replace if necessary.
- The Torx fasteners that attach the hard top to the body should be torqued as follows using the provided #50 Torx head driver and ratchet:
  - Hard top to B-pillar: 119 in-lb +/- 23 in-lb (13.5 N·m +/- 2.7 N·m)
  - Hard top to J-rail: 154 in-lb +/- 30 in-lb (17.5 N·m +/- 3.5 N·m)

**SUNRIDER® FOR HARD TOP****WARNING!**

Do not open or close the Sunrider® top while driving. Operating the top while driving could cause the driver to lose control of the vehicle. Failure to follow this warning may result in serious injury or death.

The Sunrider® soft top can be used in place of the Hard Top Freedom Panels for quick and easy opening of the area above the driver and front passenger seats.

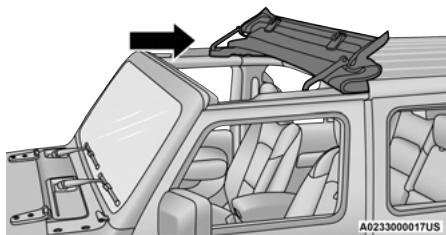
**Sunrider® For Hard Top**

To install the Sunrider® soft top, proceed as follows:

1. Remove both front Hard Top Freedom panels ↪ page 93.
2. With the help of a second person, set the Sunrider® top onto the top of the vehicle making sure to align the holes at the front and rear of the side rails.

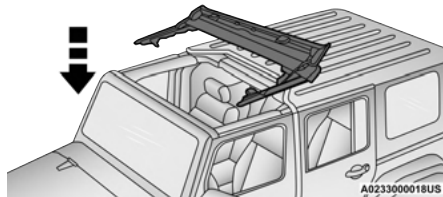
**Lower Sunrider® Onto The Vehicle**

3. Swing the front frame bracket around the side of the rail, and insert the door rail attachment bolt (provided bolt without spacer) from underneath. Tighten with a #40 Torx head driver until snug.

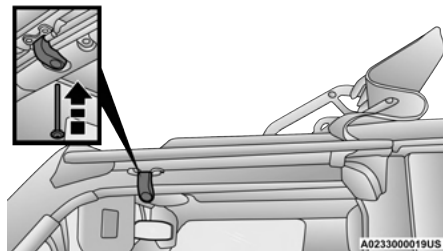
**Attach Front Door Rail Bolt**

4. Insert the rear door rail attachment bolt (provided bolt with spacer) from underneath. Tighten with #40 Torx head driver until snug.

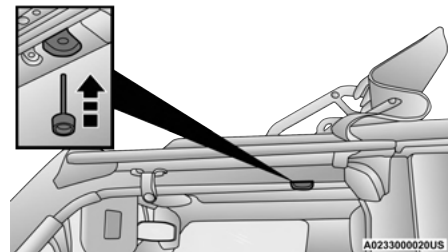
**Attach Rear Door Rail Bolt**

5. Repeat steps 3 and 4 on the other side of the vehicle.

**NOTE:**

The recommended torque specification for the front and rear door rail attachment bolts is 8.8 ft-lb (12 N·m).

6. Attach the rear clamp at the rear center of the Sunrider® top using the two provided rear clamp attachment bolts. Tighten with #40 Torx head driver until snug.

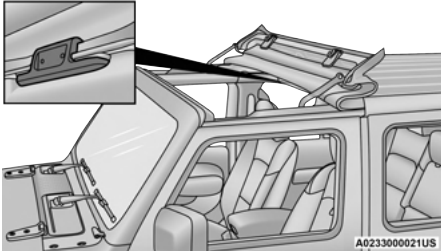

**Rear Clamp Location**

**NOTE:**

The recommended torque specification for the rear clamp attachment bolts is 3.7 ft-lb (5 N-m).

7. From inside the vehicle, lift and pull the Sunrider® top forward using the integrated handle on the front header of the top. Manually guide the top into the closed position.

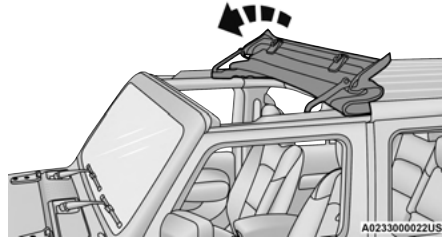

**Push Sunrider® Top Forward**

8. From inside the vehicle, pull the handle on the header latch downward to engage the hook into its receiver. Pull the handle back upward while squeezing the hook, locking the latch into place. Repeat on the other side.

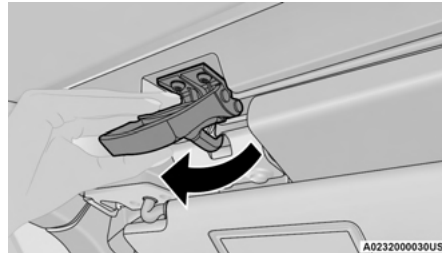

**Engage Both Header Latches**

**To Open The Sunrider® Top**

To open the Sunrider® top, proceed as follows:

1. Fold both sun visors forward against the windshield.
2. Release the header latches from the crossbar by pulling the handle downward. Make sure the hook is disengaged from its receiver.

2

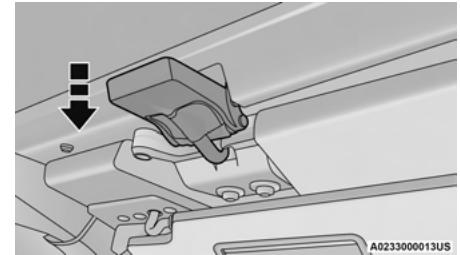

**Release Both Header Latches**

- From the front of the Sunrider® top, lift and push the top rearward to the Sunrider® position.

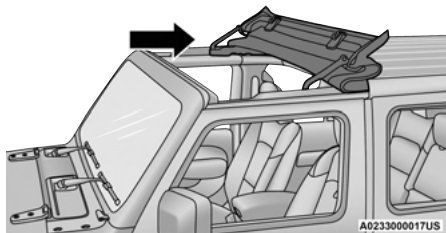

**Sunrider® Position**

- Secure the top by using the two hook-and-loop fasteners provided with the Sunrider® kit, and wrap one around the side rails on each side of the Sunrider® top to hold it in place.

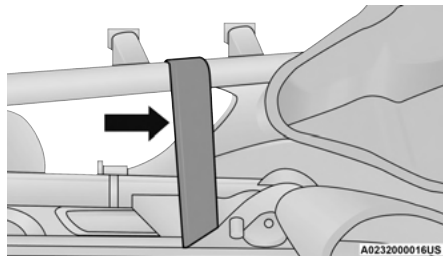

**Hook-And-Loop Fastener Placement**

## POWER SLIDING TOP — IF EQUIPPED

### CAUTION!

Lowering of the windshield is NOT recommended in vehicles equipped with a Power Sliding Top. Damage will occur to the top as well as the header seal.

If your vehicle is equipped with a Power Sliding Top, the control switch can be found on the front trim panel, to the right of the driver's side sun visor.



**Power Sliding Top Control Switch**

- Open Switch
- Close Switch

### NOTE:

- The power top is non-removable. If desired, the rear quarter windows can be removed and stored in the provided storage bag ↗ page 104.
- The power top will not open in temperatures below -4 °F (-20 °C). However, if it is opened at a higher temperature, it can be closed at temperatures above -40 °F (-40 °C).
- The power top will not operate at vehicle speeds above 60 mph (96 km/h).



**NOTE:**

A slight pause in audio may be heard when opening and closing the Power Sliding Top as a result of the Uconnect system switching between power top Closed and power top Open audio modes.

**WARNING!**

- Never leave children unattended in a vehicle, or with access to an unlocked vehicle. Never leave the key fob in or near the vehicle, or in a location accessible to children. Do not leave the Keyless Enter 'n Go™ Ignition in the ACC or ON/RUN position. Occupants, particularly unattended children, can become entrapped by the power top while operating the power top switch. Such entrapment may result in serious injury or death.
- In a collision, there is a greater risk of being thrown from a vehicle with an open power top. You could also be seriously injured or killed. Always fasten your seat belt properly and make sure all passengers are also properly secured.
- Do not allow small children to operate the power top. Never allow your fingers, other body parts, or any object, to project through the power top opening. Injury may result.

**Opening And Closing The Power Top****Express Open/Close**

Push the open switch and release it within one-half second and the power top will open automatically from any position. The power top will open fully and stop automatically.

Push the close switch and release it within one-half second and the power top will close automatically from any position. The power top will close fully and stop automatically.

During Express Open or Express Close operation, any other movement of the power top switch will stop the power top.

**Manual Open/Close**

To open the power top manually, push and hold the open switch to the full open position, then release.

To close the power top manually, push and hold the close switch to the fully closed position, then release.

Any release of the switch during open or close operation will stop the power top movement. The top will remain in a partially opened position until the switch is operated and held again.

**Pinch Protect Feature**

This feature will detect an obstruction in the opening of the power top during Express Close operation. If an obstruction in the path of the power top is detected, the power top will

automatically retract. Remove the obstruction if this occurs. Next, push the close switch and release to Express Close.

**WARNING!**

There is no anti-pinch protection when the power top is almost closed. To avoid personal injury be sure to clear your arms, hands, fingers and all objects from the top's path before closing.

2

**NOTE:**

- The Power Sliding Top may reverse motion if closing during a severe headwind. If this occurs, push and hold the Power Sliding Top switch again to close the top completely.
- If three consecutive power top close attempts result in Pinch Protect reversals, Pinch Protect will disable and the power top must be closed in Manual Mode.

**Power Top Maintenance**

Use only a non-abrasive cleaner and a soft cloth to clean the quarter window glass panel. For important information on cleaning and caring for your vehicle ⇨ page 408.

## Ignition Off Operation

The power top switch can remain active in Accessory Delay for up to approximately 10 minutes after the vehicle's ignition is placed to the OFF position. Opening either front door will cancel this feature.

### NOTE:

Ignition Off time is programmable through the Uconnect system → page 207.

## Relearn Procedure

For vehicles equipped with a power top, there is a relearn procedure that allows you to calibrate the power top when the "Express Mode" stops working. To reset the power top, follow these steps:

1. Place the ignition in the RUN position, and start the vehicle.

### NOTE:

The engine must be running to perform the relearn procedure.

2. Ensure the power top is in the fully closed position.
3. Push and hold the Close switch for 10 seconds. This will put the power top into calibration mode.

4. Continue holding down the close button while the top goes fully open and then back to fully close.
5. Once the power top has stopped in the fully closed position, release the close button. The power top is now reset and ready to use.

### NOTE:

If the close button is released anytime during the relearning process, the relearn may not be complete, and the procedure must be repeated.

## Rear Quarter Window Removal

On vehicles equipped with a Power Sliding Top, the rear quarter windows can be removed. To remove these windows, follow this procedure:

1. Open the swing gate, and lift the rear window.
2. Open both side doors nearest the quarter windows.
3. Locate the rear quarter window latches (two on each window) on the interior of the windows.

4. Rotate the left hand side latch **clockwise** to release.
5. Rotate the right hand side latch **counter-clockwise** to release.

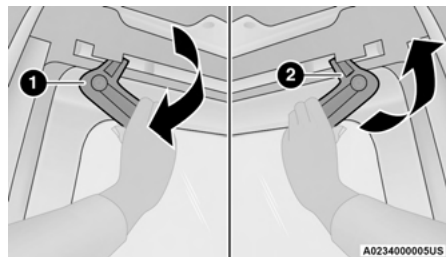

**Step Five**

- 1 — Rotate Left Handle Clockwise  
2 — Rotate Right Handle Counterclockwise

- From the outside of the vehicle, lift each window upward and away from the vehicle.

**NOTE:**

Do not pull down or apply any weight to the windows after the latches are released. Damage could result to the pins holding the windows in place.

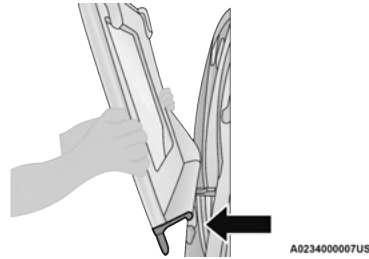
**Step Six****Step Six**

- Store the rear quarter windows in the provided storage bag and keep in a safe location, or securely fasten the bag to the rear seat.

**Quarter Window Storage Bag**

To use the storage bags for the rear quarter windows, proceed as follows:

- With the bag completely open and the fabric divider raised, place the first quarter window with the latches facing outward into the foam insert. Fold divider over the window once placed inside.

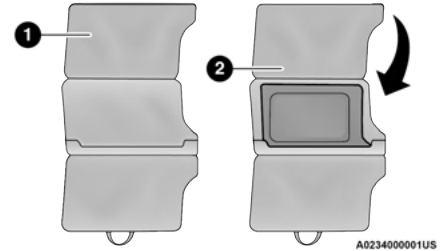
**Step One**

- 1 — Bag Open With Divider Raised
- 2 — Lower Divider Over Window (Latches Facing Outward)

- Place the second window into the foam insert with the latches facing outward. Fully close the bag.

**NOTE:**

Once both windows are placed inside the bag, the outside of the windows will be facing each other with all latches facing the outside of the bag.

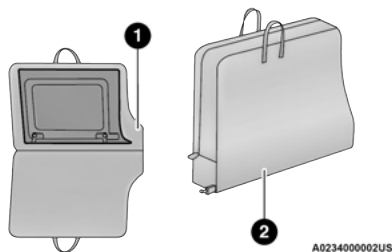
**Step Two**

1 — Second Window Placed Over Divider

2 — Fully Closed Bag

- Store the bag in a safe location, or in the cargo area of the vehicle by securing the bag in the vehicle's cargo area. This is done by attaching the straps at the top of the bag to the rear head restraints, as well as attaching the clip at the bottom of the bag to the forward most cargo hook on the load floor.

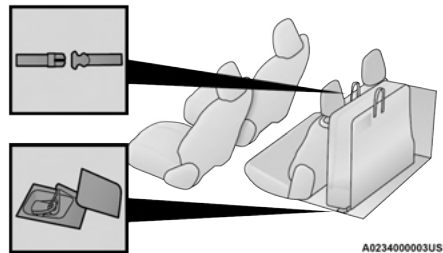
**Step Three****DOOR FRAME****WARNING!**

- Do not drive your vehicle on public roads with the door frame(s) removed as you will lose the protection that they can provide. This procedure is furnished for use during off-road operation only.
- Do not drive your vehicle on public roads with the doors removed as you will lose the protection that they can provide. This procedure is furnished for use during off-road operation only.

**CAUTION!**

Failure to follow these cautions may cause interior water damage, stains or mildew:

- Opening a door or lowering a window while the top is wet may allow water to drip into the vehicle's interior.
- Careless handling and storage of the removable door frame(s) may damage the seals, causing water to leak into the vehicle's interior.
- The door frame(s) must be positioned properly to ensure sealing. Improper installation can cause water to leak into the vehicle's interior.

## DOOR FRAME REMOVAL

### NOTE:

In four door models, the rear door frames must be removed first, followed by the front door frames.

- Using the provided #40 Torx head driver and ratchet, loosen the Torx screws located on the underside of each door frame (two per door).

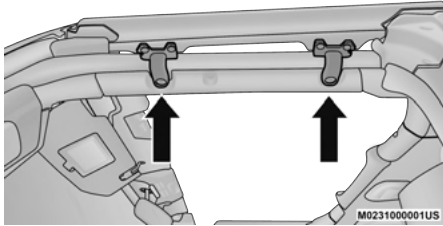

Door Frame Screw Locations

- Once all the way loosened, remove the screws by pulling downward.

### NOTE:

Screws will not fall out once completely loose, as they are held in place by an internal mechanism.

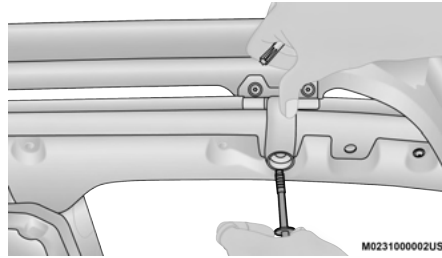

Remove Screws From Below Frame

- Lift the frame upward, removing it from the vehicle.

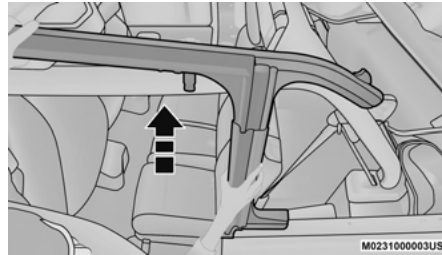

Step Three

- Store screws in a secure location.
- Repeat procedure on the front door frame (four door models).

### WARNING!

- Do not drive your vehicle on public roads with the door frame(s) removed as you will lose the protection that they can provide. This procedure is furnished for use during off-road operation only.
- Do not drive your vehicle on public roads with the doors removed as you will lose the protection that they can provide. This procedure is furnished for use during off-road operation only.

2

## DOOR FRAME INSTALLATION FOUR DOOR MODELS — IF EQUIPPED

- Install the front door rail first.
- Carefully place the front door rail in the rubber seal at the top of the windshield, and line up the holes for the Torx head screws (two for each door).

3. Swing the frame bracket around the side of the rail, and insert the screws from underneath. Tighten with #40 Torx head driver until they are snug, being careful not to cross-thread the screws or overtighten. Refer to the following table for the appropriate torque specifications for the door rail screws.

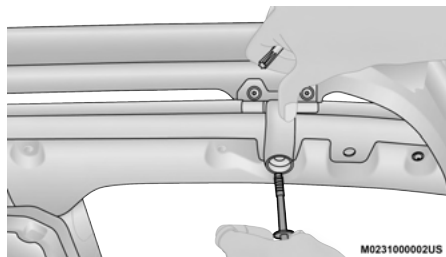

Step Three

Target Torque Specification For Torx Fasteners	Maximum	Minimum
79.6 in-lb (9 N-m)	87.6 in-lb (9.9 N-m)	71.7 in-lb (8.1 N-m)

**CAUTION!**

Do not overtighten the screws. You can strip the screws if they are overtightened.

4. Set the rear door frame pin into the hole on top of the body side, just behind the rear door opening.

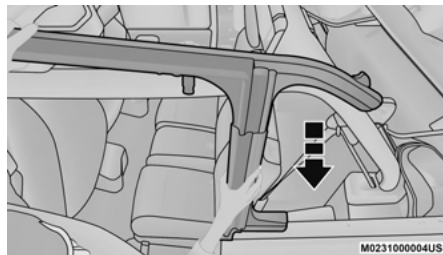

Step Four

5. Carefully position the top of the door frame onto the rear of the front door rail, making sure rubber seals lie flat. Ensure the seals are installed correctly to avoid water leaks.

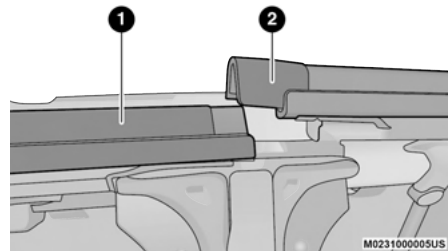

Position Of Frame Above Door

- 1 – Front Door Rail  
2 – Rear Door Frame

- Swing the frame bracket around the side of the rail, and insert the screws from underneath. Tighten with #40 Torx head driver until they are snug, being careful not to cross-thread the screws or overtighten. Refer to the previous table for the appropriate torque specifications for the door rail screws.

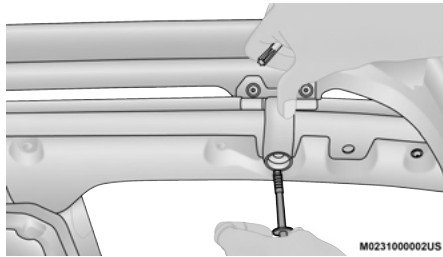

Step Six

## DOOR FRAME INSTALLATION TWO DOOR MODELS — IF EQUIPPED

- Carefully place the front door rail in the rubber seal at the top of the windshield, and line up the holes for the Torx head screws (two for each door).
- Swing the frame bracket around the side of the rail, and insert the screws from underneath. Tighten with #40 Torx head driver until they are snug, being careful not to cross-thread the

screws or overtighten. Refer to the following table for the appropriate torque specifications for the door rail screws.

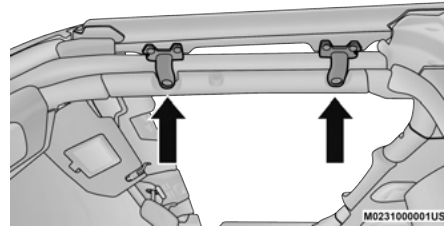

Step Two

Target Torque Specification For Torx Fasteners	Maximum	Minimum
79.6 in-lb (9 N·m)	87.6 in-lb (9.9 N·m)	71.7 in-lb (8.1 N·m)

### CAUTION!

Do not overtighten the screws. You can strip the screws if they are overtightened.

## FOLDING WINDSHIELD

### CAUTION!

Lowering of the windshield is NOT recommended in vehicles equipped with a Power Sliding Top. Damage will occur to the top as well as the header seal.

The fold-down windshield on your vehicle is a structural element that can provide some protection in some accidents. The windshield also provides some protection against weather, road debris and intrusion of small branches and other objects.

Do not drive your vehicle on-road with the windshield down, as you lose the protection this structural element can provide.

If required for certain off-road uses, the windshield can be folded down. However, the protection afforded by the windshield is then lost. If you fold down the windshield, drive slowly and cautiously. It is recommended that the speed of the vehicle be limited to 10 mph (16 km/h), with low range operation preferred if you are driving off-road with the windshield folded down.

Raise the windshield as soon as the task that required its removal is completed and before you return to on-road driving. Both you and your

passengers should wear seat belts at all times, on-road and off-road, regardless of whether the windshield is raised or folded down.

### WARNING!

Carefully follow these warnings to help protect against personal injury:

- Do not drive your vehicle on-road with the windshield down.
- Do not drive your vehicle unless the windshield is securely fastened, either up or down.
- Eye protection, such as goggles, should be worn at all times when the windshield is down.
- Be sure that you carefully follow the instructions for raising the windshield. Make sure that the folding windshield, windshield wipers, side bars, and all associated hardware and fasteners are correctly and tightly assembled before driving your vehicle. Failure to follow these instructions may prevent your vehicle from providing you and your passengers' protection in some accidents.
- If you remove the doors, store them outside the vehicle. In the event of an accident, a loose door may cause personal injury.

## LOWERING THE WINDSHIELD

1. Before completing the following steps:
  - If your vehicle is equipped with a Soft Top, the top **MUST** be lowered, and the door rails must be removed prior to lowering the windshield.
  - If your vehicle is equipped with a Hard Top, the Freedom Panels **MUST** be removed prior to lowering the windshield.
  - Refer to the following instructions for more information:
    - Soft Top Lowering ⇨ page 85
    - Door Frame ⇨ page 106
    - Freedom Top Panels ⇨ page 93

### CAUTION!

Failure to follow this step will cause damage to the vehicle's header seal.

2. Manually remove the protective caps over the windshield wiper hex bolts.

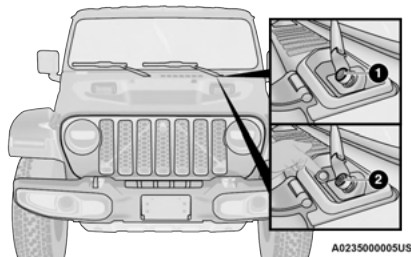

### Step Two

- 1 — Hex Bolt Cover Installed
- 2 — Hex Bolt Cover Removed

3. Using the provided 15 mm socket, remove the two hex bolts and remove the wiper arms.
4. Move to the inside of the vehicle and lower both sun visors.



- Using the provided #40 Torx head driver, remove the four Torx screws located along the interior of the windshield.

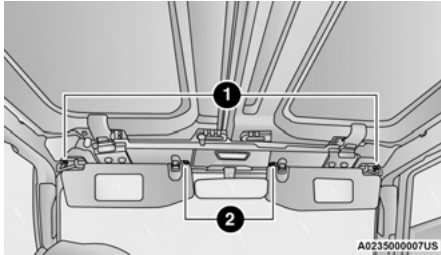

Step Five

- Outside Torx Screws
- Inside Torx Screws

**NOTE:**

Store all of the mounting bolts in their original threaded holes and tighten for safekeeping.

- Lower the windshield gently until it contacts the tie-down bumpers (if equipped).

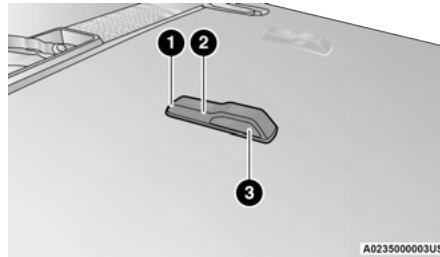

Step Six

- Washer Nozzle
- Bumper
- Tie-Down

- Secure the windshield by passing a cinch strap through the tie-down on either side of the hood and on the windshield frame. Tighten the strap to secure the windshield in place.

**CAUTION!**

Do Not Overtighten! Damage to the windshield could result.

## Adaptive Cruise Control (ACC)/Forward Collision Warning (FCW) Sensor Protective Cover — If Equipped

Your vehicle may be equipped with a protective cover that is to be used whenever the windshield is folded down in order to protect the Adaptive Cruise Control (ACC)/Forward Collision Warning (FCW) sensor. To install the cover, follow these instructions:

- Secure the top part of the cover so that it hinges to the header.
- Swing the cover down and push on it so that it covers the opening.
- Check to make sure the cover is secured properly.

**NOTE:**

Be sure to remove the cover before returning the windshield to the normal position. Store the cover in the cargo area.

**Cleaning Instructions**

During windshield down applications, dust/dirt can accumulate in the cover and block the camera lens. Use a microfiber cloth to clean the camera lens, module, and inside cover, being careful not to damage or scratch the module.

## RAISING THE WINDSHIELD

1. Release the strap that secured the windshield in the lowered position.
2. Raise the windshield.
3. Using the provided #40 Torx head driver, reinstall the four Torx screws located along the interior of the windshield. Secure them until they are snug, being careful not to cross-thread the screws or overtighten.

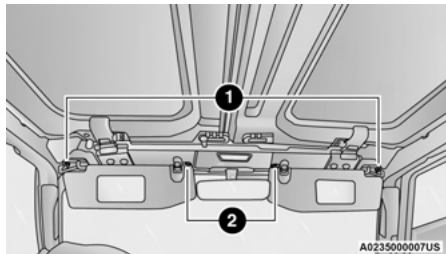

**Interior Torx Screw Locations**

- 1 – Outside Torx Screws
- 2 – Inside Torx Screws

4. Reinstall the windshield wiper arms using the provided 15 mm socket. First, align the tips of the blade to the “T” mark in the glass. Then,

while holding the arm in that position, reinstall the hex nut and tighten until snug. Be careful not to overtighten. Repeat for the other arm.

5. Reinstall the protective caps over the wiper arm hex bolts and push gently until they snap into place.

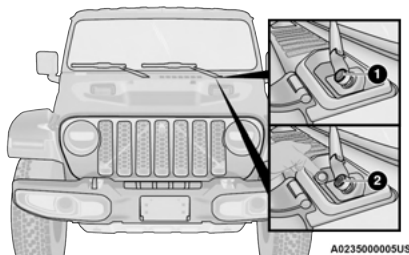

**Step Five**

- 1 – Hex Bolt Cover Installed
- 2 – Hex Bolt Cover Removed

6. After completing the steps above:
  - If your vehicle is equipped with a Soft Top, reinstall the Door Rails and raise the top.
  - If your vehicle is equipped with a Hard Top, reinstall the Freedom Panels.

## HOOD

### OPENING THE HOOD

If applicable, refer to the “Hybrid Supplement” for additional information.

Release both of the outside hood latches.

Raise the hood slightly, and place a hand palm-side down in the center of the hood opening. Locate the safety latch in the middle, and push the latch to the right to open.

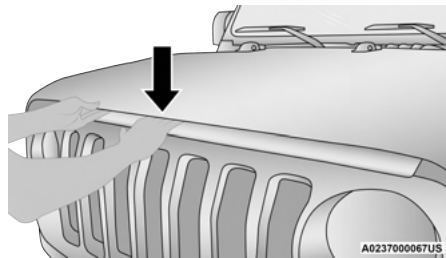

**Place Hand In Hood Opening**

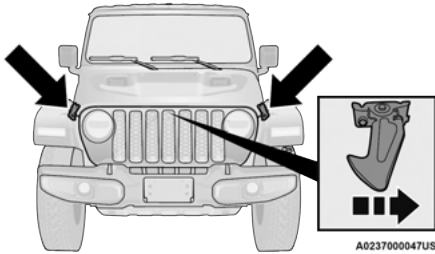
**Hood Latch Locations**

Remove the support rod from the hood, and insert it into the radiator crossmember.

**NOTE:**

You may have to push down slightly on the hood before pushing the safety latch.

**CLOSING THE HOOD**

If applicable, refer to the "Hybrid Supplement" for additional information.

To close the hood, remove the support rod from the slot and replace it on the hood panel retaining clip. Lower the hood slowly. Secure both of the hood latches.

**WARNING!**

Be sure the hood is fully latched before driving your vehicle. If the hood is not fully latched, it could open when the vehicle is in motion and block your vision. Failure to follow this warning could result in serious injury or death.

**CAUTION!**

To prevent possible damage, do not slam the hood to close it.

**REAR SWING GATE**

The rear swing gate can be unlocked by using one of the following methods:

- Mechanical key (with mechanical lock — if equipped)
- Remote Keyless Entry key fob (if equipped)
- Power door unlock switch on the front doors (if equipped)
- Passive Entry swing gate handle (if equipped)

To open the swing gate, pull on the handle.

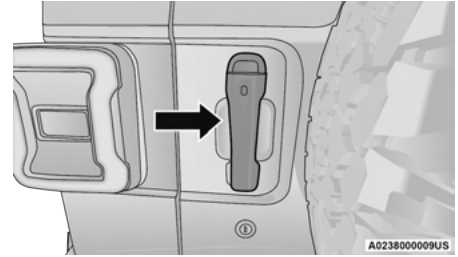
**Swing Gate Handle****NOTE:**

Close the rear flip-up window before attempting to close the swing gate (hard top models only).

**WARNING!**

Driving with the flip-up window open can allow poisonous exhaust gases into your vehicle. You and your passengers could be injured by these fumes. Keep the flip-up window closed when you are operating the vehicle.

**CAUTION!**

Do not push on rear wiper blade when closing the rear flip-up window, as damage to the blade will result.

**NOTE:**

The swing gate hinges and check strap may require cleaning if a squeak can be heard when opening the swing gate. Progressive accumulation of dirt or debris on the check strap arm may cause failure of the check strap, requiring replacement. For further information on vehicle cleaning procedures, see [page 411](#).

**CARGO AREA FEATURES****Trail Rail Cargo Organizer — If Equipped**

If your vehicle is equipped with the Trail Rail system, a rail will be found built into the floor on either side of the cargo area. Each rail contains an adjustable anchor loop that can be used to secure cargo. The position of the adjustable anchor loop can be adjusted by sliding the loop along the rail.

To adjust the anchor loop, push down on the center button while sliding the loop along the rail to the desired position. Release the button and move the loop slightly to the next fixed position in the notches of the rail.

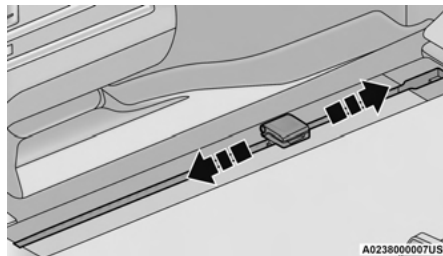
**Adjustable Anchor Loop**

Lift the loop to use.

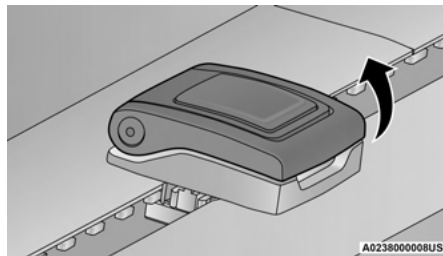
**Lift Adjustable Anchor Loop****ROOF LUGGAGE RACK — IF EQUIPPED****NOTE:**

Roof rack applications are for Hard Top models **ONLY**.

The load carried on the roof, when equipped with a luggage rack, must not exceed 100 lb (45 kg), this includes the weight of the crossbars, and it should be uniformly distributed over the cargo area.

Crossbars should always be used whenever cargo is placed on the roof rack. Check the straps frequently to be sure that the load remains securely attached.

**NOTE:**

Crossbars can be purchased at an authorized dealer through Mopar® parts.

External racks do not increase the total load carrying capacity of the vehicle. Be sure that the total occupant and luggage load inside the vehicle, plus the load on the luggage rack, do not exceed the maximum vehicle load capacity.

**WARNING!**

Cargo must be securely tied down before driving your vehicle. Improperly secured loads can fly off the vehicle, particularly at high speeds, resulting in personal injury or property damage. Follow the roof rack cautions when carrying cargo on your roof rack.

**CAUTION!**

- To avoid damage to the roof rack and vehicle, do not exceed the maximum roof rack load capacity. Always distribute heavy loads as evenly as possible and secure the load appropriately.
- Long loads, which extend over the windshield, should be secured to both the front and rear of the vehicle.
- Place a blanket or other protection between the surface of the roof and the load.
- Travel at reduced speeds and turn corners carefully when carrying large or heavy loads on the roof rack. Wind forces, due to natural causes or nearby truck traffic, can add sudden upward lift. It is recommended to not carry large flat loads, such as wood panels or surfboards, which may result in damage to the cargo or your vehicle.
- Load should always be secured to crossbars first, with tie down loops used as additional securing points if needed. Tie loops are intended as supplementary tie down points only. Do not use ratcheting mechanisms with the tie loops. Check the straps frequently to be sure that the load remains securely attached.

# GETTING TO KNOW YOUR INSTRUMENT PANEL

## INSTRUMENT CLUSTER

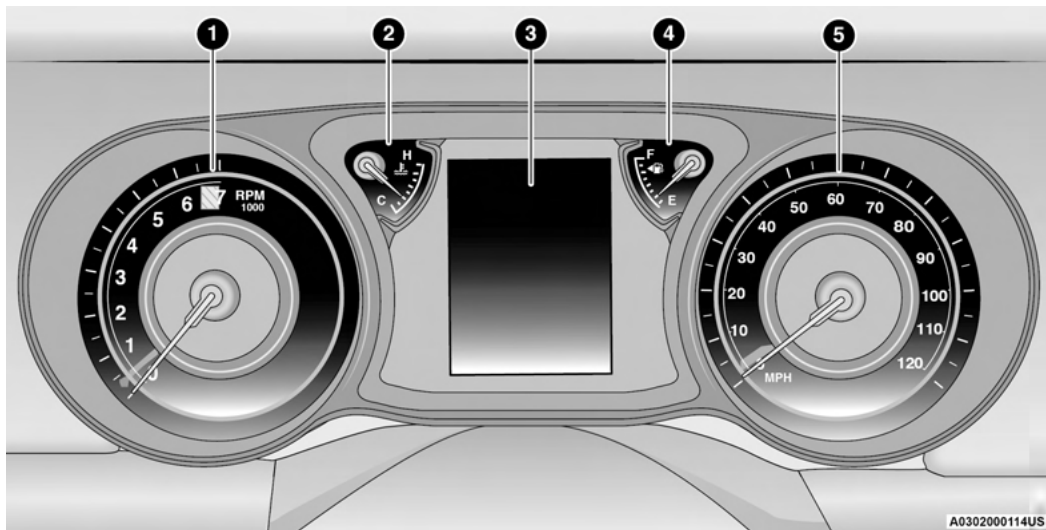

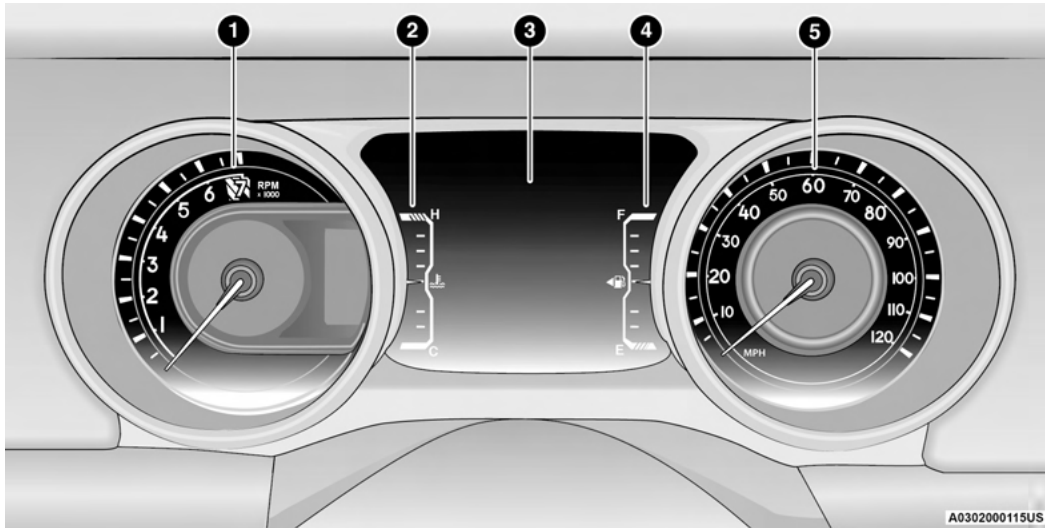

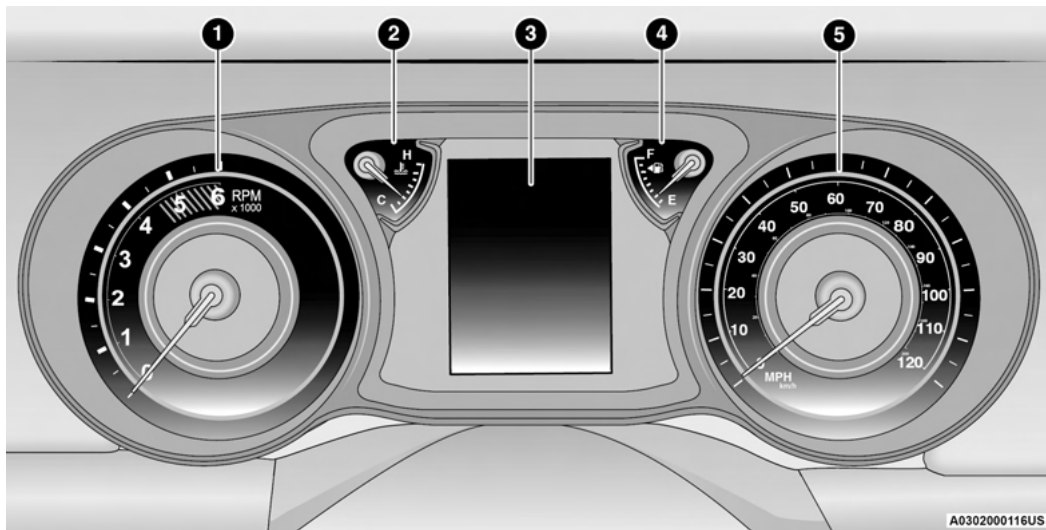

A0302000116US



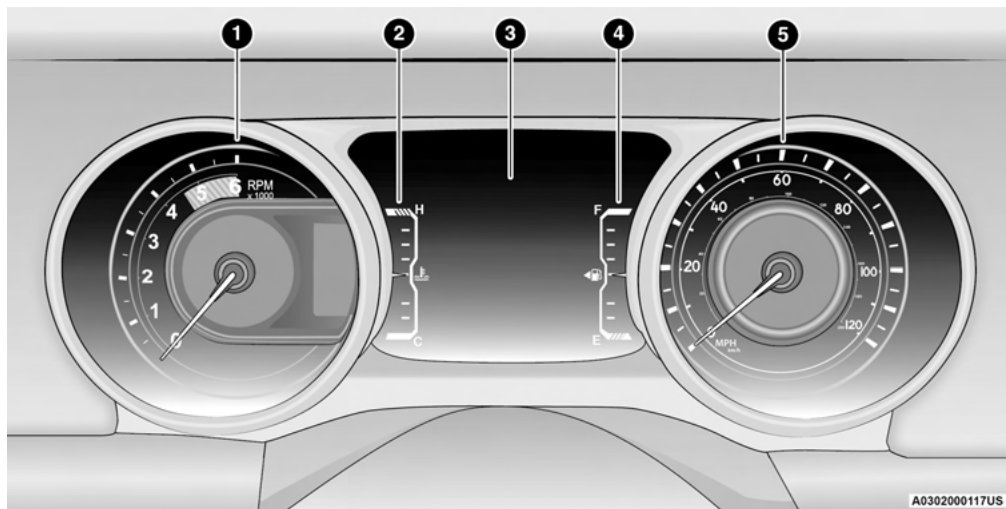

## INSTRUMENT CLUSTER DESCRIPTIONS

### 1. Tachometer

- Indicates the engine speed in revolutions per minute (RPM x 1000).

#### CAUTION!

Do not operate the engine with the tachometer pointer in the red area. Engine damage will occur.

### 2. Temperature Gauge

- The temperature gauge shows engine coolant temperature. Any reading within the normal range indicates that the engine cooling system is operating satisfactorily.
- The pointer will likely indicate a higher temperature when driving in hot weather, up mountain grades, or when towing a trailer. It should not be allowed to exceed the upper limits of the normal operating range.

#### WARNING!

A hot engine cooling system is dangerous. You or others could be badly burned by steam or boiling coolant. It is recommended to call an authorized dealer for service if your vehicle overheats.

#### CAUTION!

Driving with a hot engine cooling system could damage your vehicle. If the temperature gauge reads "H" pull over and stop the vehicle. Idle the vehicle with the air conditioner turned off until the pointer drops back into the normal range. If the pointer remains on the "H", turn the engine off immediately and call an authorized dealer for service.

### 3. Instrument Cluster Display

- The instrument cluster display features a driver interactive display ↗ page 120.

### 4. Fuel Gauge

- The pointer shows the level of fuel in the fuel tank when the ignition switch is in the ON/RUN position.



- The fuel pump symbol points to the side of the vehicle where the fuel filler door is located.

### 5. Speedometer

- Indicates vehicle speed.

## INSTRUMENT CLUSTER DISPLAY

Your vehicle will be equipped with an instrument cluster display, which offers useful information to the driver. With the ignition in the OFF mode, opening/closing of a door will activate the display for viewing, and display the total miles, or kilometers, in the odometer. Your instrument cluster display is designed to display important information about your vehicle's systems and features. Using a driver interactive display located on the instrument panel, your instrument cluster display can show you how systems are working and give you warnings when they aren't. The steering wheel mounted controls allow you to scroll through and enter the main menus and submenus. You can access the specific information you want and make selections and adjustments.

## INSTRUMENT CLUSTER DISPLAY LOCATION AND CONTROLS

The instrument cluster display is located in the center of the instrument cluster.

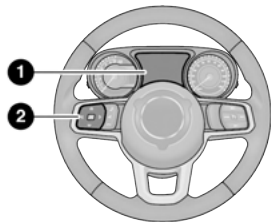

A0302000127US

**Instrument Cluster Display Location**

- 1 – Instrument Cluster Display Screen
- 2 – Instrument Cluster Display Controls

The system allows the driver to select information by pushing the following buttons mounted on the steering wheel:

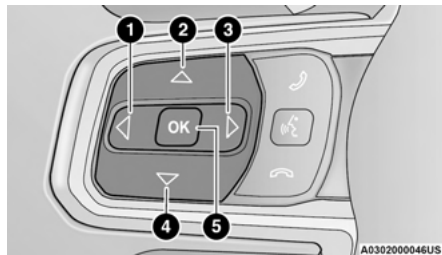

**Instrument Cluster Display Control Buttons**

- 1 – Left Arrow Button
- 2 – Up Arrow Button
- 3 – Right Arrow Button
- 4 – Down Arrow Button
- 5 – OK Button

### ● Left Arrow Button

Push and release the **left** arrow button to access the information screens or submenu screens of a main menu item.

### ● Up Arrow Button

Push and release the **up** arrow button to scroll upward through the Main Menu items.

### ● Right Arrow Button

Push and release the **right** arrow button to access the information screens or submenu screens of a main menu item.

### ● Down Arrow Button

Push and release the **down** arrow button to scroll downward through the Main Menu items.

### ● OK Button

Push the **OK** button to access/select the information screens or submenu screens of a Main Menu item. Push and hold the **OK** arrow button for two seconds to reset displayed/selected features that can be reset.

3

## OIL CHANGE RESET — IF EQUIPPED

Your vehicle may be equipped with an engine oil change indicator system. The “Oil Change Required” message will display in the instrument cluster display for five seconds after a single chime has sounded to indicate the next scheduled oil change interval. The engine oil change indicator system is duty cycle based, which means the engine oil change interval may fluctuate, dependent upon your personal driving style.

Unless reset, this message will continue to display each time you place the ignition in the ON/RUN position. To turn off the message temporarily, push and release the **OK** button. To reset the oil change indicator system (after performing the scheduled maintenance), refer to the following procedure.

**Oil Life Reset**

1. Without pushing the brake pedal, place the ignition in the ON/RUN mode (do not start the engine).
2. Navigate to "Oil Life" submenu in "Vehicle Info" in the instrument cluster display.
3. Push and hold the **OK** button until the gauge resets to 100%.

**Secondary Method For Oil Change Reset Procedure**

1. Without pushing the brake pedal, place the ignition in the ON/RUN position (do not start the engine).
2. Fully press the accelerator pedal, slowly, three times within ten seconds.
3. Without pushing the brake pedal, place the ignition in the OFF position.

**NOTE:**

If the indicator message illuminates when you start the vehicle, the oil change indicator system did not reset. If necessary, repeat this procedure.

**INSTRUMENT CLUSTER DISPLAY****SELECTABLE ITEMS**

The instrument cluster display can be used to view the following main menu items:

**NOTE:**

Depending on the vehicles options, feature settings may vary.

Speedometer	Driver Assist – If Equipped	Stop/Start
Vehicle Info	Fuel Economy	Audio
Off Road	Trip Info	Messages
Screen Setup	Settings	Phone Call Status

**Speedometer**

Push and release the **up**  $\Delta$  or **down**  $\nabla$  arrow button until the speedometer menu icon is displayed in the instrument cluster display. Push and release the **OK** button to toggle between MPH and km/h.

**Vehicle Info**

Push and release the **up**  $\Delta$  or **down**  $\nabla$  arrow button until the Vehicle Info menu icon is displayed in the instrument cluster display. Push and release the **left**  $\triangleleft$  or **right**  $\triangleright$  arrow button to scroll through the information submenus and push and release the **OK** button to select or reset the resettable submenus.

Tire Pressure	Single Gauge Submenu – If Equipped	Critical Level Logic – If Equipped
Oil Life	Diesel Exhaust Fluid Level – If Equipped	Coolant Temperature
Oil Pressure	Oil Temperature	Transmission Temperature – Automatic Transmission Only
Battery Voltage		

## Off Road

Push and release the **up** ▲ or **down** ▼ arrow button until the Off Road menu icon is displayed in the instrument cluster display. Push and release the **left** ◀ or **right** ▶ arrow button to scroll through the information submenus.

- Drivetrain
  - Front Wheel Angle: displays the graphical and numerical value of calculated average front wheel angle from the steering wheel orientation.
  - Transfer Case Lock Status: displays “Lock” graphic only during 4WD High, 4WD High Part Time, 4WD Low status.
  - Axle Lock And Sway Bar Status (If Equipped): displays front and rear or rear only axle locker graphic, and sway bar connection graphic with text message (connected or disconnected).
- Pitch And Roll
  - Displays the pitch and roll of the vehicle in the graphic with the angle number on the screen.

### NOTE:

When vehicle speed becomes too high to display the pitch and roll, “-” will display in place of the numbers, and the graphic will be greyed out. A

message indicating the necessary speed for the feature to become available will also display.

## Driver Assist – If Equipped

The Driver Assist menu displays the status of the ACC systems.

Push and release the **up** ▲ or **down** ▼ arrow button until the Driver Assist menu is displayed in the instrument cluster display.

### Adaptive Cruise Control (ACC) Feature – If Equipped

The instrument cluster display displays the current ACC system settings. The information displayed depends on ACC system status.

Push the ACC ON/OFF button (located on the steering wheel) until one of the following displays in the instrument cluster display:

#### Adaptive Cruise Control Off

When ACC is deactivated, the display will read “Adaptive Cruise Control Off.”

#### Adaptive Cruise Control Ready

When ACC is activated but the vehicle speed setting has not been selected, the display will read “Adaptive Cruise Control Ready.”

Push the SET + or the SET - button (located on the steering wheel), and the following will display in the instrument cluster display.

## ACC SET

When ACC is set, the set speed will display in the instrument cluster.

The ACC screen may display once again if any of the following ACC activity occurs:

- System Cancel
- Driver Override
- System Off
- ACC Proximity Warning
- ACC Unavailable Warning

### NOTE:

The instrument cluster display will return to the last display selected after five seconds of no ACC display activity ↷ page 171.

## Fuel Economy

Push and release the **up** ▲ or **down** ▼ arrow button until the Fuel Economy icon is highlighted in the instrument cluster display. Push and hold the **OK** button to reset average fuel economy feature.

Toggle **left** ◀ or **right** ▶ to select a display with or without Current Fuel Economy Information.

- Range – The display shows the estimated distance (mi or km) that can be traveled with the fuel remaining in the tank. When the Range value is less than 10 miles (16 kilometers), the Range display will change to a “LOW” message. Adding a significant amount of fuel to the

vehicle will turn off the “LOW” message and a new Range value will display. Range cannot be reset through the **OK** button.

#### NOTE:

Significant changes in driving style or vehicle loading will greatly affect the actual drivable distance of the vehicle, regardless of the Range displayed value.

- Average – The display shows the average fuel economy (MPG, L/100 km, or km/L) since the last reset.
- Current – This display shows the current fuel economy (MPG, L/100 km, km/L) while driving.

#### Trip Info

Push and release the **up** ▲ or **down** ▼ arrow button until the Trip icon/title is highlighted in the instrument cluster display, then push and release the **left** ◀ or **right** ▶ arrow button to select Trip A or Trip B.

The Trip A and Trip B information will display the following:

- Distance
- Average Fuel Economy
- Elapsed Time

Hold the **OK** button to reset all the information.

#### Stop/Start – If Equipped

Push and release the **up** ▲ or **down** ▼ arrow button until the Stop/Start icon/title is highlighted in the instrument cluster display. The screen will display the Stop/Start status.

#### Audio

Push and release the **up** ▲ or **down** ▼ arrow button until the Audio Menu icon/title is highlighted in the instrument cluster display. This menu will display the audio source information, including the Song name, Artist name, and audio source with an accompanying graphic.

#### Messages

Push and release the **up** ▲ or **down** ▼ arrow button until the Messages Menu item is highlighted. This feature shows the number of stored warning messages. Pushing the **right** ▶ arrow button will allow you to see what the stored messages are.

When no messages are present, a “No Stored Messages” will display.

#### Screen Setup

Push and release the **up** ▲ or **down** ▼ arrow button until the Screen Setup Menu Icon/Title is highlighted in the instrument cluster display. Push and release the **OK** button to enter the submenus and follow the prompts on the screen as needed.

The Screen Setup feature allows you to change what information is displayed in the instrument cluster as well as the location that information is displayed.

#### Screen Setup Driver Selectable Items

Upper Left and Right		
None	Current Econ (or L/100km, km/L)	Average Econ (or L/100km, km/L)
Outside Temp	Compass	Trip A Distance
Range To Empty	Time	Trip B Distance

Center		
None	Compass	Time
Outside Temp	Average Econ (or L/100km, km/L)	Trip A Distance
Range to Empty	Audio	Speedometer
Current Econ (or L/100km, km/L)	Trip B Distance	Menu Title

Favorite Menus		
Speedometer	Stop/Start	Vehicle Info
Off Road – If Equipped (show/hide)	Messages	Driver Assist – If Equipped (show/hide)
Fuel Economy (show/hide)	Settings	Trip Info (Show/Hide)
Audio (show/hide)	Screen Setup	

#### Gear Display — If Equipped

- Full
- Single

#### Current Gear — If Equipped

- On
- Off

#### Odometer — If Equipped

- Show
- Hide

#### Defaults (Restores All Settings To Default Settings)

- Cancel
- Restore

The menu with (show/hide) means user can press **OK** button to choose show or hide this menu on the instrument cluster display.

#### Phone Call Status

A pop-up message for an incoming call will appear on any screen within your instrument cluster. The pop-up message will appear on your screen until it is cleared out of the call is ignored, answered, or the calling ends.

#### NOTE:

The Uconnect Settings can be programmed to turn the pop-up off. This will not affect the audio menu or any phone status information ⇨ page 207.

Any incoming calls, active calls, and outgoing calls will take the place of your audio information.

A caller's name will only be displayed if:

- A number is associated with the call. The phone number will be displayed in place of the caller's name.
- The test/font of the name is not supported by the instrument cluster. The instrument cluster will not display anything in place of the name.
- The caller's name exceeds the maximum number of characters. The last two to three digits that will fit will be replaced with "...".

#### NOTE:

Any audio information will return to the instrument cluster once the call has ended.

### BATTERY SAVER ON/BATTERY SAVER MODE MESSAGE — ELECTRICAL LOAD REDUCTION ACTIONS — IF EQUIPPED

This vehicle is equipped with an Intelligent Battery Sensor (IBS) to perform additional monitoring of the electrical system and status of the vehicle battery.

In cases when the IBS detects charging system failure, or the vehicle battery conditions are deteriorating, electrical load reduction actions will take place to extend the driving time and distance of the vehicle. This is done by reducing power to or turning off non-essential electrical loads.

Load reduction is only active when the engine is running. It will display a message if there is a risk of battery depletion to the point where the vehicle may stall due to lack of electrical supply, or will not restart after the current drive cycle.

When load reduction is activated, the message "Battery Saver On" or "Battery Saver Mode" will appear in the instrument cluster display.

These messages indicate the vehicle battery has a low state of charge and continues to lose electrical charge at a rate that the charging system cannot sustain.

**NOTE:**

- The charging system is independent from load reduction. The charging system performs a diagnostic on the charging system continuously.
- If the Battery Charge Warning Light is on it may indicate a problem with the charging system  
↳ page 129.

The electrical loads that may be switched off (if equipped), and vehicle functions which can be effected by load reduction:

- Heated Seat/Vented Seats/Heated Wheel
- Rear Defroster And Heated Mirrors
- HVAC System
- 150W Power Inverter System
- Audio and Telematics System

Loss of the battery charge may indicate one or more of the following conditions:

- The charging system cannot deliver enough electrical power to the vehicle system because the electrical loads are larger than the capability of the charging system. The charging system is still functioning properly.
- Turning on all possible vehicle electrical loads (e.g. HVAC to max settings, exterior and interior lights, overloaded power outlets +12 Volt, 150W, USB ports) during certain driving conditions (city driving, towing, frequent stopping).

- Installing options like additional lights, upfitter electrical accessories, audio systems, alarms and similar devices.
- Unusual driving cycles (short trips separated by long parking periods).
- The vehicle was parked for an extended period of time (weeks, months).
- The battery was recently replaced and was not charged completely.
- The battery was discharged by an electrical load left on when the vehicle was parked.
- The battery was used for an extended period with the engine not running to supply radio, lights, chargers, +12 Volt portable appliances like vacuum cleaner's, game consoles and similar devices.

**What to do when an electrical load reduction action message is present ("Battery Saver On" or "Battery Saver Mode")**

During a trip:

- Reduce power to unnecessary loads if possible:
  - Turn off redundant lights (interior or exterior)
  - Check what may be plugged in to power outlets +12 Volt, 150W, USB ports
  - Check HVAC settings (blower, temperature)
  - Check the audio settings (volume)

After a trip:

- Check if any aftermarket equipment was installed (additional lights, upfitter electrical accessories, audio systems, alarms) and review specifications if any (load and Ignition Off Draw currents).
- Evaluate the latest driving cycles (distance, driving time and parking time).
- The vehicle should have service performed if the message is still present during consecutive trips and the evaluation of the vehicle and driving pattern did not help to identify the cause.

## DIESEL DISPLAYS

When the appropriate conditions exist, the following messages display in the instrument cluster display:

- Exhaust Filter Nearing Full Safely Drive at Consistent Speeds to Clear
- Exhaust Filter Full – Power Reduced See Dealer
- Exhaust System Service Required – See Dealer
- Exhaust System – Filter XX% Full Service Required See Dealer
- Exhaust System Regeneration in Process Continue Driving
- Exhaust System – Regeneration Completed



## DIESEL PARTICULATE FILTER (DPF) MESSAGES

This engine meets all required diesel engine emissions standards. To achieve these emissions standards, your vehicle is equipped with a state-of-the-art engine and exhaust system. These systems are seamlessly integrated into your vehicle and managed by the Powertrain Control Module (PCM). The PCM manages engine combustion to allow the exhaust system's catalyst to trap and burn Particulate Matter (PM) pollutants, with no input or interaction on your part.

### WARNING!

A hot exhaust system can start a fire if you park over materials that can burn. Such materials might be grass or leaves coming into contact with your exhaust system. Do not park or operate your vehicle in areas where your exhaust system can contact anything that can burn.

### CAUTION!

The engine may be switched off even if the warning light is on: repeated interruptions of the regeneration process could cause an early deterioration of engine oil. For this reason it is always advisable to wait for the symbol to go off before turning off the engine, following the instructions above. Do not complete the DPF regeneration process when the vehicle is stopped.

Your vehicle has the ability to alert you to additional maintenance required on your vehicle or engine. Refer to the following messages that may be displayed on your instrument cluster display:

- **Exhaust Filter Nearing Full Safely Drive at Consistent Speeds to Clear** — This message will be displayed if the exhaust particulate filter reaches 80% of its maximum storage capacity. Under conditions of exclusive short duration and low speed driving cycles, your diesel engine and exhaust after-treatment system may never reach the conditions required to cleanse the filter to remove the trapped PM. If this occurs, the “Exhaust Filter XX% Full Safely Drive at Highway Speeds to Remedy” message will be displayed. If this message is displayed, you will hear one chime to assist in alerting you of this condition. By simply driving your vehicle at highway speeds for up to 20 minutes, you can

remedy the condition in the particulate filter system and allow your diesel engine and exhaust after-treatment system to cleanse the filter to remove the trapped PM and restore the system to normal operating condition.

- **Exhaust System Regeneration in Process Continue Driving** — This message indicates that the DPF is self-cleaning. Maintain your current driving condition until regeneration is completed.
- **Exhaust System — Regeneration Completed** — This message indicates that the DPF self-cleaning is completed. If this message is displayed, you will hear one chime to assist in alerting you of this condition.
- **Exhaust System Service Required — See Dealer** — This messages indicates regeneration has been disabled due to a system malfunction. At this point the engine Powertrain Control Module (PCM) will register a fault code, the instrument panel will display a Malfunction Indicator Light (MIL).

### CAUTION!

See an authorized dealer, as damage to the exhaust system could occur soon with continued operation.

### ● Exhaust Filter Full — Power Reduced

**See Dealer** — This message indicates the PCM has derated the engine to limit the likelihood of permanent damage to the after-treatment system. If this condition is not corrected and a dealer service is not performed, extensive exhaust after-treatment damage can occur. To correct this condition it will be necessary to have your vehicle serviced by an authorized dealer.

#### NOTE:

Failing to follow the oil change indicator, changing your oil and resetting the oil change indicator by 0 miles (0 kilometers) remaining will prevent the diesel exhaust filter from performing its cleaning routine. This will shortly result in a Malfunction Indicator Light (MIL) and reduced engine power. Only an authorized dealer will be able to correct this condition.

#### CAUTION!

See an authorized dealer, as damage to the exhaust system could occur soon with continued operation.

## FUEL SYSTEM MESSAGES

The following chart contains a list of different messages that may appear in the instrument cluster, depending on different system or fuel

conditions. Use the descriptions to interpret what the message means and determine the best action to take.

## WARNING LIGHTS AND MESSAGES

The warning/indicator lights will illuminate in the instrument panel together with a dedicated message and/or acoustic signal when applicable. These indications are indicative and precautionary and as such must not be considered as exhaustive and/or alternative to the information contained in the Owner's Manual, which you are advised to read carefully in all cases. Always refer to the information in this chapter in the event of a failure indication. All active telltales will display first if applicable. The system check menu may appear different based upon equipment options and current vehicle status. Some telltales are optional and may not appear.

### RED WARNING LIGHTS

#### Air Bag Warning Light



This warning light will illuminate to indicate a fault with the air bag, and will turn on for four to eight seconds as a bulb check when the ignition is placed in the ON/RUN or ACC/ON/RUN position. This light will illuminate with a single chime when a fault with the air bag has been detected, it will stay on until the fault is cleared. If the light is not on during startup,

stays on, or turns on while driving, have the system inspected at an authorized dealer as soon as possible.

#### Brake Warning Light



This warning light monitors various brake functions, including brake fluid level and parking brake application. If the brake light turns on it may indicate that the parking brake is applied, that the brake fluid level is low, or that there is a problem with the Anti-Lock Brake System reservoir.

If the light remains on when the parking brake has been disengaged, and the fluid level is at the full mark on the master cylinder reservoir, it indicates a possible brake hydraulic system malfunction or that a problem with the Brake Booster has been detected by the Anti-Lock Brake System (ABS) / Electronic Stability Control (ESC) system. In this case, the light will remain on until the condition has been corrected. If the problem is related to the brake booster, the ABS pump will run when applying the brake, and a brake pedal pulsation may be felt during each stop.

The dual brake system provides a reserve braking capacity in the event of a failure to a portion of the hydraulic system. A leak in either half of the dual brake system is indicated by the Brake Warning Light, which will turn on when the brake fluid level in the master cylinder has dropped below a specified level.

The light will remain on until the cause is corrected.

**NOTE:**

The light may flash momentarily during sharp cornering maneuvers, which change fluid level conditions. The vehicle should have service performed, and the brake fluid level checked.

If brake failure is indicated, immediate repair is necessary.

**WARNING!**

Driving a vehicle with the red brake light on is dangerous. Part of the brake system may have failed. It will take longer to stop the vehicle. You could have a collision. Have the vehicle checked immediately.

Vehicles equipped with the Anti-Lock Brake System (ABS) are also equipped with Electronic Brake Force Distribution (EBD). In the event of an EBD failure, the Brake Warning Light will turn on along with the ABS Light. Immediate repair to the ABS is required.

Operation of the Brake Warning Light can be checked by turning the ignition switch from the OFF position to the ON/RUN position. The light should illuminate for approximately two seconds. The light should then turn off unless the parking brake is

applied or a brake fault is detected. If the light does not illuminate, have the light inspected by an authorized dealer.

The light also will turn on when the parking brake is applied with the ignition switch in the ON/RUN position.

**NOTE:**

This light shows only that the parking brake is applied. It does not show the degree of brake application.

**Battery Charge Warning Light**



This warning light will illuminate when the battery is not charging properly. If it stays on while the engine is running, there may be a malfunction with the charging system. Contact an authorized dealer as soon as possible.

This indicates a possible problem with the electrical system or a related component.

**Door Open Warning Light**



This indicator will illuminate when a door is ajar/open and not fully closed.

**NOTE:**

If the vehicle is moving, there will also be a single chime.

**Electric Power Steering (EPS) Fault Warning Light**



This warning light will turn on when there's a fault with the EPS system  
 ↪ page 164.

**WARNING!**

Continued operation with reduced assist could pose a safety risk to yourself and others. Service should be obtained as soon as possible.

3

**Electronic Throttle Control (ETC) Warning Light**



This warning light will illuminate to indicate a problem with the ETC system. If a problem is detected while the vehicle is running, the light will either stay on or flash depending on the nature of the problem. Cycle the ignition when the vehicle is safely and completely stopped and the transmission is placed in the PARK (P) position. The light should turn off. If the light remains on with the vehicle running, your vehicle will usually be drivable; however, see an authorized dealer for service as soon as possible.

**NOTE:**

This light may turn on if the accelerator and brake pedals are pressed at the same time.

If the light continues to flash when the vehicle is running, immediate service is required and you may experience reduced performance, an elevated/rough idle, or engine stall and your vehicle may require towing. The light will come on when the ignition is placed in the ON/RUN or ACC/ON/RUN position and remain on briefly as a bulb check. If the light does not come on during starting, have the system checked by an authorized dealer.

### Engine Coolant Temperature Warning Light



This warning light warns of an overheated engine condition. If the engine coolant temperature is too high, this indicator will illuminate and a single chime will sound. If the temperature reaches the upper limit, a continuous chime will sound for four minutes or until the engine is able to cool, whichever comes first.

If the light turns on while driving, safely pull over and stop the vehicle. If the Air Conditioning (A/C) system is on, turn it off. Also, shift the transmission into NEUTRAL (N) and idle the vehicle. If the temperature reading does not return to normal, turn the engine off immediately and call for service [↪ page 341](#).

### Hood Open Warning Light



This indicator will illuminate when the hood is ajar/open and not fully closed.

#### NOTE:

If the vehicle is moving, there will also be a single chime.

### Oil Pressure Warning Light



This warning light will illuminate, and a chime will sound, to indicate low engine oil pressure. If the light and chime turn on while driving, safely stop the vehicle and turn off the engine as soon as possible. After the vehicle is safely stopped, restart the engine and monitor the Oil Pressure Warning Light. If the Oil Pressure Warning Light is still illuminated, turn the engine OFF and contact an authorized dealer for further assistance. Do not operate the vehicle until the cause is corrected. If the lamp is no longer illuminated, the engine can be operated but it is recommended to take the vehicle to an authorized dealer as soon as possible.

Do not operate the vehicle until the cause is corrected. This light does not indicate how much oil is in the engine. The engine oil level must be checked under the hood.

### Oil Temperature Warning Light



This warning light will illuminate to indicate the engine oil temperature is high. If the light turns on while driving, stop the vehicle and shut off the engine as soon as possible. Wait for oil temperature to return to normal levels.

### Seat Belt Reminder Warning Light



This warning light indicates when the driver or passenger seat belt is unbuckled. When the ignition is first placed in the ON/RUN or ACC/ON/RUN position and if the driver's seat belt is unbuckled, a chime will sound and the light will turn on. When driving, if the driver or front passenger seat belt remains unbuckled, the Seat Belt Reminder Light will flash or remain on continuously and a chime will sound [↪ page 295](#).

### Swing Gate Open Warning Light



This warning light will illuminate when the swing gate is open.

#### NOTE:

If the vehicle is moving, there will also be a single chime.

## Transmission Temperature Warning Light — If Equipped



This warning light will illuminate to warn of a high transmission fluid temperature. This may occur with strenuous usage such as trailer towing. If this light turns on, stop the vehicle and run the engine at idle or slightly faster, with the transmission in PARK (P) or NEUTRAL (N), until the light turns off. Once the light turns off, you may continue to drive normally.

### WARNING!

If you continue operating the vehicle when the Transmission Temperature Warning Light is illuminated you could cause the fluid to boil over, come in contact with hot engine or exhaust components and cause a fire. If you continue to operate the vehicle when the “CLUTCH HOT” message is displayed, or the Transmission Temperature Warning Light is illuminated, you could cause the clutch to overheat and cause a fire.

### CAUTION!

Continuous driving with the Transmission Temperature Warning Light illuminated will eventually cause severe transmission damage or transmission failure. If you continue to operate the vehicle when the “CLUTCH HOT” message is displayed, or the Transmission Temperature Warning Light is illuminated, you could cause the clutch to overheat and cause severe clutch damage, transmission damage, or failure.

## Vehicle Security Warning Light — If Equipped



This light will flash at a fast rate for approximately 15 seconds when the Vehicle Security system is arming, and then will flash slowly until the vehicle is disarmed.

## YELLOW WARNING LIGHTS

### Anti-Lock Brake System (ABS) Warning Light



This warning light monitors the ABS. The light will turn on when the ignition is placed in the ON/RUN or ACC/ON/RUN position and may stay on for as long as four seconds.

If the ABS light remains on or turns on while driving, then the Anti-Lock portion of the brake system is not functioning and service is required as soon as possible. However, the conventional brake system will continue to operate normally, assuming the Brake Warning Light is not also on.

If the ABS light does not turn on when the ignition is placed in the ON/RUN or ACC/ON/RUN position, have the brake system inspected by an authorized dealer.

### Electronic Stability Control (ESC) Active Warning Light — If Equipped



This warning light will indicate when the Electronic Stability Control system is Active. The ESC Indicator Light in the instrument cluster will come on when the ignition is placed in the ON/RUN or ACC/ON/RUN position, and when ESC is activated. It should go out with the engine running. If the ESC Indicator Light comes on continuously with the engine running, a malfunction has been detected in the ESC system. If this warning light remains on after several ignition cycles, and the vehicle has been driven several miles (kilometers) at speeds greater than 30 mph (48 km/h), see an authorized dealer as soon as possible to have the problem diagnosed and corrected.

- The ESC OFF Indicator Light and the ESC Indicator Light come on momentarily each time the ignition is placed in the ON/RUN or ACC/ON/RUN position.
- The ESC system will make buzzing or clicking sounds when it is active. This is normal; the sounds will stop when ESC becomes inactive.
- This light will come on when the vehicle is in an ESC event.

### Electronic Stability Control (ESC) OFF Warning Light — If Equipped



This warning light indicates the ESC is off. Each time the ignition is turned to ON/RUN or ACC/ON/RUN, the ESC system will be on, even if it was turned off previously.

### Loose Fuel Filler Cap Warning Light — If Equipped



This warning light will illuminate when the fuel filler cap is loose. Properly close the filler cap to disengage the light. If the light does not turn off, please see an authorized dealer.

### Low Fuel Warning Light



When the fuel level reaches approximately 2.0 gal (7.5 L), this light will turn on and a chime will sound. The light will remain on until fuel is added.

### Low Washer Fluid Warning Light — If Equipped



This warning light will illuminate when the windshield washer fluid is low  
 ↳ page 355.

### Engine Check/Malfunction Indicator Warning Light (MIL)



The MIL is a part of an Onboard Diagnostic system called OBD II that monitors engine and automatic transmission control systems. This

warning light will illuminate when the ignition is in the ON/RUN position before engine start. If the bulb does not come on when turning the ignition switch from OFF to ON/RUN, have the condition checked promptly.

Certain conditions, such as a loose or missing gas cap, poor quality fuel, etc., may illuminate the light after engine start. The vehicle should be serviced if the light stays on through several typical driving styles. In most situations, the vehicle will drive normally and will not require towing.

When the engine is running, the MIL may flash to alert serious conditions that could lead to immediate loss of power or severe catalytic converter damage. The vehicle should be serviced by an authorized dealer as soon as possible if this occurs.

### WARNING!

A malfunctioning catalytic converter, as referenced above, can reach higher temperatures than in normal operating conditions. This can cause a fire if you drive slowly or park over flammable substances such as dry plants, wood, cardboard, etc. This could result in death or serious injury to the driver, occupants or others.

### CAUTION!

Prolonged driving with the Malfunction Indicator Light (MIL) on could cause damage to the vehicle control system. It also could affect fuel economy and driveability. If the MIL is flashing, severe catalytic converter damage and power loss will soon occur. Immediate service is required.

### AdBlue® (UREA) Injection System Failure Warning Light — If Equipped



This warning light will illuminate along with a dedicated message on the display (if equipped) if an unknown fluid not conforming with acceptable characteristics is inserted, or if an average consumption of AdBlue® (UREA) over 50% is detected. Contact an authorized dealer as soon as possible.

If the problem is not solved, a specific message will appear on the instrument cluster display whenever a certain threshold is reached until it will no longer be possible to start the engine.

When about 125 miles (200 km) are remaining before the AdBlue® (UREA) tank is empty, a continuous dedicated message will appear on the instrument panel, accompanied by a chime.

### Service 4WD Warning Light — If Equipped

 This warning light will illuminate to signal a fault with the 4WD system. If the light stays on or comes on during driving, it means that the 4WD system is not functioning properly and that service is required. We recommend you drive to the nearest service center and have the vehicle serviced immediately.

### Service Forward Collision Warning (FCW) Light — If Equipped

 This warning light will illuminate to indicate a fault in the Forward Collision Warning System. Contact an authorized dealer for service ↪ page 288.

### Service Stop/Start System Warning Light — If Equipped

 This warning light will illuminate when the Stop/Start system is not functioning properly and service is required. Contact an authorized dealer for service.

### Cruise Control Fault Warning Light

 This warning light will illuminate to indicate the Cruise Control system is not functioning properly and service is required. Contact an authorized dealer.

### Sway Bar Fault Warning Light

 This light will illuminate when there is a fault in the sway bar disconnect system ↪ page 162.

### Tire Pressure Monitoring System (TPMS) Warning Light

 The warning light switches on and a message is displayed to indicate that the tire pressure is lower than the recommended value and/or that slow pressure loss is occurring. In these cases, optimal tire duration and fuel consumption may not be guaranteed.

Should one or more tires be in the condition mentioned above, the display will show the indications corresponding to each tire.

### CAUTION!

Do not continue driving with one or more flat tires as handling may be compromised. Stop the vehicle, avoiding sharp braking and steering. If a tire puncture occurs, repair immediately using the dedicated tire repair kit and contact an authorized dealer as soon as possible.

3

Each tire, including the spare (if provided), should be checked monthly when cold and inflated to the inflation pressure recommended by the vehicle manufacturer on the vehicle placard or tire inflation pressure label. If your vehicle has tires of a different size than the size indicated on the vehicle placard or tire inflation pressure label, you should determine the proper tire inflation pressure for those tires.

As an added safety feature, your vehicle has been equipped with a TPMS that illuminates a low tire pressure telltale when one or more of your tires is significantly underinflated. Accordingly, when the low tire pressure telltale illuminates, you should stop and check your tires as soon as possible, and inflate them to the proper pressure. Driving on a significantly under inflated tire causes the tire to overheat and can lead to tire failure. Underinflation also reduces fuel efficiency and tire tread life, and may affect the vehicle's handling and stopping ability.

Please note that the TPMS is not a substitute for proper tire maintenance, and it is the driver's responsibility to maintain correct tire pressure, even if underinflation has not reached the level to trigger illumination of the TPMS low tire pressure telltale.

Your vehicle has also been equipped with a TPMS malfunction indicator to indicate when the system is not operating properly. The TPMS malfunction indicator is combined with the low tire pressure telltale. When the system detects a malfunction, the telltale will flash for approximately one minute and then remain continuously illuminated. This sequence will continue upon subsequent vehicle start-ups as long as the malfunction exists. When the malfunction indicator is illuminated, the system may not be able to detect or signal low tire pressure as intended. TPMS malfunctions may occur for a variety of reasons, including the installation of replacement or alternate tires or wheels on the vehicle that prevent the TPMS from functioning properly. Always check the TPMS malfunction telltale after replacing one or more tires or wheels on your vehicle to ensure that the replacement or alternate tires and wheels allow the TPMS to continue to function properly.

### CAUTION!

The TPMS has been optimized for the original equipment tires and wheels. TPMS pressures and warning have been established for the tire size equipped on your vehicle. Undesirable system operation or sensor damage may result when using replacement equipment that is not of the same size, type, and/or style. Aftermarket wheels can cause sensor damage. Using aftermarket tire sealants may cause the Tire Pressure Monitoring System (TPMS) sensor to become inoperable. After using an aftermarket tire sealant it is recommended that you take your vehicle to an authorized dealer to have your sensor function checked.

### Sway Bar Fault Warning Light



This light will illuminate when there is a fault in the sway bar disconnect system → page 162.

### YELLOW INDICATOR LIGHTS

#### Sway Bar Indicator Light — If Equipped



This indicator light will illuminate when the front sway bar is disconnected → page 162.

#### 4WD Indicator Light — If Equipped



This light alerts the driver that the vehicle is in the Four-Wheel Drive (4WD) mode, and the front and rear driveshafts are mechanically locked together forcing the front and rear wheels to rotate at the same speed.

#### 4WD Low Indicator Light — If Equipped



This light alerts the driver that the vehicle is in the 4WD Low mode. The front and rear driveshafts are mechanically locked together forcing the front and rear wheels to rotate at the same speed. Low range provides a greater gear reduction ratio to provide increased torque at the wheels → page 157.

#### 4WD Part Time Indicator Light — If Equipped



This light alerts the driver that the vehicle is in the four-wheel drive part time mode, and the front and rear driveshafts are mechanically locked together forcing the front and rear wheels to rotate at the same speed.

#### Axle Locker Fault Indicator Light



This light indicates when the front and/or rear axle locker fault has been detected.



### Forward Collision Warning (FCW) OFF Indicator Light — If Equipped



This indicator light illuminates to indicate that Forward Collision Warning is off  
 ⇨ page 288.

### Front And Rear Axle Lock Indicator Light



This light indicates when the front, rear, or both axles have been locked. The telltale will display the lock icon on the front and rear axles to indicate the current lock status.

### Neutral Indicator Light — If Equipped



This light alerts the driver that the vehicle is in the neutral mode.

### Rear Axle Lock Indicator Light



This light indicates when the rear axle lock has been activated ⇨ page 157.

### Service Adaptive Cruise Control Warning Light — If Equipped



This light will turn on when a ACC is not operating and needs service  
 ⇨ page 171.

### Sway Bar Indicator Light — If Equipped



This indicator light will illuminate when the front sway bar is disconnected  
 ⇨ page 162.

### Wait To Start Light — If Equipped



This indicator light will illuminate for approximately two seconds when the ignition is turned to the ON/RUN position. Its duration may be longer based on

colder operating conditions. Vehicle will not initiate start until telltale is no longer displayed  
 ⇨ page 139.

#### NOTE:

The Wait To Start Light may not illuminate if the intake manifold temperature is warm enough.

### Low Diesel Emissions Additive AdBlue® (UREA) Indicator Light — If Equipped



The Low Diesel Exhaust Emissions Additive AdBlue® (UREA) indicator light illuminates when the AdBlue® (UREA) level is low.

Fill the AdBlue® (UREA) tank as soon as possible with at least 1.3 gallons (5 liters) of AdBlue® (UREA).

If filling the tank is done with a remaining range of AdBlue® (UREA) in the tank equal to zero, you may need to wait two minutes before starting the vehicle.

### Water In Fuel Indicator Light — If Equipped



The Water In Fuel Indicator Light will illuminate when there is water detected in the fuel filter. If this light remains on, DO NOT start the vehicle before you drain the water from the fuel filter to prevent engine damage, and please see an authorized dealer.

#### CAUTION!

The presence of water in the fuel system circuit may cause severe damage to the injection system and irregular engine operation. If the indicator light is illuminated, contact an authorized dealer as soon as possible to bleed the system. If the above indications come on immediately after refuelling, water, or AdBlue® UREA has probably been poured into the tank: switch the engine off immediately and contact an authorized dealer.

### GREEN INDICATOR LIGHTS

#### Adaptive Cruise Control (ACC) Set With No Target Detected Indicator Light — If Equipped



This light will turn on when the Adaptive Cruise Control is set and there is no vehicle in front detected ⇨ page 171.

### Adaptive Cruise Control (ACC) Set With Target Light — If Equipped



This will display when the ACC is set and a vehicle in front is detected

↪ page 171.

### 4WD Auto Indicator Light — If Equipped



This light alerts the driver that the vehicle is in the four-wheel drive auto mode. The system will provide power to all four wheels and shift the power between the

front and rear axles as needed. This will provide maximum traction in dry and slippery conditions.

### Cruise Control SET Indicator Light — If Equipped With A Premium Instrument Cluster



This indicator light will illuminate when the Cruise Control is set to the desired speed ↪ page 169.

### Front Fog Indicator Light — If Equipped



This indicator light will illuminate when the front fog lights are on ↪ page 57.

### Parking/Headlights On Indicator Light



This indicator light will illuminate when the parking lights or headlights are turned on.

### Stop/Start Active Indicator Light — If Equipped



This indicator light will illuminate when the Stop/Start function is in “Autostop” mode.

### Turn Signal Indicator Lights



When the left or right turn signal is activated, the turn signal indicator will flash independently and the corresponding exterior turn signal lamps will flash. Turn signals can be activated when the multifunction lever is moved down (left) or up (right).

#### NOTE:

- A continuous chime will sound if the vehicle is driven more than 1 mile (1.6 km) with either turn signal on.
- Check for an inoperative outside light bulb if either indicator flashes at a rapid rate.

### WHITE INDICATOR LIGHTS

#### Adaptive Cruise Control (ACC) Ready Light — If Equipped



This light will turn on when the vehicle equipped with ACC has been turned on, but not set.

### 2WD High Indicator Light — If Equipped With a Premium Instrument Cluster



This light alerts the driver that the vehicle is in the two-wheel drive high mode.

### Hill Descent Control (HDC) Indicator Light — If Equipped



This indicator shows when the HDC feature is turned on. The lamp will be on solid when HDC is armed. HDC can only be armed when the transfer case is in the

4WD Low position and the vehicle speed is less than 30 mph (48 km/h). If these conditions are not met while attempting to use the HDC feature, the HDC indicator light will flash on/off.

### Selec-Speed Control Indicator Light — If Equipped



This light will turn on when “Selec-Speed Control” is activated.

To activate “Selec-Speed Control”, ensure the vehicle is in 4WD Low and push the button on the Instrument Panel.

#### NOTE:

If the vehicle is not in 4WD Low, “To Enter Selec-Speed Shift to 4WD Low” will appear in the instrument cluster display.

### Cruise Control Ready Indicator Light — If Equipped With A Premium Instrument Cluster



This light will turn on when the Cruise Control has been turned on, but not set.

### Cruise Control SET Indicator Light — If Equipped With Base Instrument Cluster



This indicator light will illuminate when the Cruise Control is set.

## BLUE INDICATOR LIGHTS

### High Beam Indicator Light



This indicator light will illuminate to indicate that the high beam headlights are on. With the low beams activated, push the multifunction lever forward

(toward the front of the vehicle) to turn on the high beams. Pull the multifunction lever rearward (toward the rear of the vehicle) to turn off the high beams. If the high beams are off, pull the lever toward you for a temporary high beam on, "flash to pass" scenario.

## GRAY INDICATOR LIGHTS

### Cruise Control Ready Indicator Light — If Equipped With Base Instrument Cluster



This light will turn on when the Cruise Control has been turned on, but not set.

## ONBOARD DIAGNOSTIC SYSTEM — OBD II

Your vehicle is equipped with a sophisticated Onboard Diagnostic system called OBD II. This system monitors the performance of the emissions, engine, and transmission control systems. When these systems are operating properly, your vehicle will provide excellent performance and fuel economy, as well as engine emissions well within current government regulations.

If any of these systems require service, the OBD II system will turn on the Malfunction Indicator Light (MIL). It will also store diagnostic codes and other information to assist your service technician in making repairs. Although your vehicle will usually be drivable and not need towing, see an authorized dealer for service as soon as possible.

### CAUTION!

- Prolonged driving with the MIL on could cause further damage to the emission control system. It could also affect fuel economy and driveability. The vehicle must be serviced before any emissions tests can be performed.
- If the MIL is flashing while the vehicle is running, severe catalytic converter damage and power loss will soon occur. Immediate service is required.

3

## ONBOARD DIAGNOSTIC SYSTEM (OBD II) CYBERSECURITY

Your vehicle is required to have OBD II and a connection port to allow access to information related to the performance of your emissions controls. Authorized service technicians may need to access this information to assist with the diagnosis and service of your vehicle and emissions system → page 207.

### WARNING!

- ONLY an authorized service technician should connect equipment to the OBD II connection port in order to read the VIN, diagnose, or service your vehicle.

(Continued)

**WARNING!**

- If unauthorized equipment is connected to the OBD II connection port, such as a driver-behavior tracking device, it may:
  - Be possible that vehicle systems, including safety related systems, could be impaired or a loss of vehicle control could occur that may result in an accident involving serious injury or death.
  - Access, or allow others to access, information stored in your vehicle systems, including personal information.

## EMISSIONS INSPECTION AND MAINTENANCE PROGRAMS

In some localities, it may be a legal requirement to pass an inspection of your vehicle's emissions control system. Failure to pass could prevent vehicle registration.



For states that require an Inspection and Maintenance (I/M), this check verifies the Malfunction Indicator Light (MIL) is functioning and is not on when the engine is running, and that the OBD II system is ready for testing.

The OBD II system may **not** be ready if your vehicle was recently serviced, recently had a depleted battery or a battery replacement. If the OBD II system should be determined not ready for the I/M test, your vehicle may fail the test.

Your vehicle has a simple ignition actuated test, which you can use prior to going to the test station. To check if your vehicle's OBD II system is ready, you must do the following:

1. Cycle the ignition switch to the ON position, but do not crank or start the engine.

**NOTE:**

If you crank or start the engine, you will have to start this test over.

2. As soon as you cycle the ignition switch to the ON position, you will see the Malfunction Indicator Light (MIL) symbol come on as part of a normal bulb check.
3. Approximately 15 seconds later, one of two things will happen:
  - The MIL will flash for about 10 seconds and then return to being fully illuminated until you turn OFF the ignition or start the engine. This means that your vehicle's OBD II system is **not ready** and you should **not** proceed to the I/M station.

- The MIL will not flash at all and will remain fully illuminated until you place the ignition in the off position or start the engine. This means that your vehicle's OBD II system is **ready** and you can proceed to the I/M station.

If your OBD II system is **not ready**, you should see an authorized dealer or repair facility. If your vehicle was recently serviced or had a battery failure or replacement, you may need to do nothing more than drive your vehicle as you normally would in order for your OBD II system to update. A recheck with the above test routine may then indicate that the system is **now ready**.

Regardless of whether your vehicle's OBD II system is ready or not, if the MIL is illuminated during normal vehicle operation you should have your vehicle serviced before going to the I/M station. The I/M station can fail your vehicle because the MIL is on with the engine running.

# STARTING AND OPERATING

## STARTING THE ENGINE — GASOLINE ENGINE (IF EQUIPPED)

Before starting your vehicle, adjust your seat, adjust both inside and outside mirrors, and fasten your seat belts.

### WARNING!

- When exiting the vehicle, always remove the key fob from the ignition and lock your vehicle.
- Never leave children alone in a vehicle, or with access to an unlocked vehicle.
- Allowing children to be in a vehicle unattended is dangerous for a number of reasons. A child or others could be seriously or fatally injured. Children should be warned not to touch the parking brake, brake pedal or the gear selector.
- Do not leave the key fob in or near the vehicle, or in a location accessible to children. A child could operate power windows, other controls, or move the vehicle.
- Do not leave children or animals inside parked vehicles in hot weather. Interior heat build-up may cause serious injury or death.

## MANUAL TRANSMISSION — IF EQUIPPED

Apply the parking brake, place the gear selector in NEUTRAL, and press the clutch pedal before starting the vehicle. This vehicle is equipped with a clutch interlocking ignition system. It will not start unless the clutch pedal is pressed to the floor.

### Four-Wheel Drive Models Only

In 4L mode, if the vehicle is stalled, the engine will start regardless of whether or not the clutch pedal is pressed to the floor. This feature enhances off-road performance by allowing the vehicle to start when in 4L without having to press the clutch pedal. The 4L Indicator Light will illuminate when the transfer case has been shifted into this mode.

## AUTOMATIC TRANSMISSION — IF EQUIPPED

Start the vehicle with the gear selector in the PARK position (vehicle can also be started in NEUTRAL). Apply the brake before shifting to any driving range.

## NORMAL STARTING

### To Turn On The Engine Using The ENGINE START/STOP Button

1. The transmission must be in PARK or NEUTRAL.
2. Press and hold the brake pedal while pushing the ENGINE START/STOP button once.
3. The system takes over and attempts to start the vehicle. If the vehicle fails to start, the starter will disengage automatically after 10 seconds.
4. If you wish to stop the cranking of the engine prior to the engine starting, push the button again.

### NOTE:

Normal starting of either a cold or a warm engine is obtained without pumping or pressing the accelerator pedal.

### To Turn Off The Engine Using The ENGINE START/STOP Button

1. Place the gear selector in PARK, then push and release the ENGINE START/STOP button.
2. The ignition will return to the OFF position.

3. If the gear selector is not in PARK (with vehicle stopped) and the ENGINE START/STOP button is pushed once, the transmission will automatically select PARK and the engine will turn off while the ignition will remain in the ACC position (NOT the OFF position). Never leave a vehicle out of the PARK position, or it could roll.
4. If the gear selector is in NEUTRAL, and the vehicle speed is below 5 mph (8 km/h), pushing the START/STOP button once will turn the engine off. The ignition will remain in the ACC position.
5. If the vehicle speed is above 5 mph (8 km/h), the ENGINE START/STOP button must be held for two seconds (or three short pushes in a row) to turn the engine off. The ignition will remain in the ACC position (NOT the OFF position) if the engine is turned off when the transmission is not in PARK.

**NOTE:**

The system will automatically time out and the ignition will cycle to the OFF position after 30 minutes of inactivity if the ignition is left in the ACC or RUN (engine not running) position and the transmission is in PARK.

**ENGINE START/STOP Button Functions — With Driver's Foot OFF The Brake Pedal (In PARK Or NEUTRAL Position)**

The ENGINE START/STOP button operates similar to an ignition switch. It has three positions: OFF, ACC, and RUN. To change the ignition positions without starting the vehicle and use the accessories, follow these steps:

1. Start with the ignition in the OFF position.
2. Push the ENGINE START/STOP button once to place the ignition to the ACC position (instrument cluster will display "ACC").
3. Push the ENGINE START/STOP button a second time to place the ignition to the RUN position (instrument cluster will display "ON/RUN").
4. Push the ENGINE START/STOP button a third time to return the ignition to the OFF position (instrument cluster will display "OFF").

**AUTOPARK**

AutoPark is a supplemental feature to assist in placing the vehicle in PARK should the situations on the following pages occur. It is a back-up system and should not be relied upon as the primary method by which the driver shifts the vehicle into PARK.

The conditions under which AutoPark will engage are outlined on the following pages.

**WARNING!**

- Driver inattention could lead to failure to place the vehicle in PARK. ALWAYS DO A VISUAL CHECK that your vehicle is in PARK by verifying that a solid (not blinking) "P" is indicated in the instrument cluster display and on the gear selector. If the "P" indicator is blinking, your vehicle is not in PARK. As an added precaution, always apply the parking brake when exiting the vehicle.
- AutoPark is a supplemental feature. It is not designed to replace the need to shift your vehicle into PARK. It is a back-up system and should not be relied upon as the primary method by which the driver shifts the vehicle into PARK.

**If the vehicle is not in PARK and the driver turns off the engine, the vehicle may AutoPark.**

AutoPark will engage when all of these conditions are met:

- Vehicle is equipped with an 8-speed transmission
- Driver's door is ajar or if the driver's door is removed and the driver is not on the seat (seat pad sensor detects driver missing)

- Vehicle is not in PARK
- Vehicle speed is 1.2 mph (1.9 km/h) or less
- Ignition is switched from RUN to OFF

**NOTE:**

For Keyless Enter 'n Go™ equipped vehicles, the engine will turn off and the ignition switch will change to ACC position.

**If the vehicle is not in PARK and the driver exits the vehicle with the engine running, the vehicle may AutoPark.**

AutoPark will engage when all of these conditions are met:

- Vehicle is equipped with an 8-speed transmission
- Driver's door is ajar or if the driver's door is removed and the driver is not on the seat (seat pad sensor detects driver missing)
- Vehicle is not in PARK
- Vehicle speed is 1.2 mph (1.9 km/h) or less
- Driver's seat belt is unbuckled
- Brake pedal is not pressed

The message "**AutoPark Engaged Shift to P then Shift to Gear**" will display in the instrument cluster.

**NOTE:**

In some cases the ParkSense graphic will be displayed in the instrument cluster. In these cases,

the gear selector must be returned to "P" to select desired gear.

**If the driver shifts into PARK while moving, the vehicle may AutoPark.**

AutoPark will engage **ONLY** when vehicle speed is 1.2 mph (1.9 km/h) or less.

The message "**Vehicle Speed is Too High to Shift to P**" will be displayed in the instrument cluster if vehicle speed is above 1.2 mph (1.9 km/h).

**WARNING!**

If vehicle speed is above 1.2 mph (1.9 km/h), the transmission will default to NEUTRAL until the vehicle speed drops below 1.2 mph (1.9 km/h). A vehicle left in the NEUTRAL position can roll. As an added precaution, always apply the parking brake when exiting the vehicle.

**4L**

**AutoPark will be disabled when operating the vehicle in 4L.**

The message "**AutoPark Disabled**" will be displayed in the instrument cluster.

**Additional customer warnings will be given when both of these conditions are met:**

- Vehicle is not in PARK
- Driver's door is ajar

The message "**AutoPark Not Engaged**" will be displayed in the instrument cluster. A warning chime will continue until you shift the vehicle into PARK or the driver's door is closed.

**ALWAYS DO A VISUAL CHECK** that your vehicle is in PARK by looking for the "P" in the instrument cluster display and on the gear selector. As an added precaution, always apply the parking brake when exiting the vehicle.

**EXTREME COLD WEATHER  
(BELOW -22° F OR -30° C)**

To ensure reliable starting at these temperatures, use of an externally powered electric engine block heater (available from an authorized dealer) is recommended.

**EXTENDED PARK STARTING****NOTE:**

Extended Park condition occurs when the vehicle has not been started or driven for at least 30 days.

1. Install a battery charger or jumper cables to the battery to ensure a full battery charge during the crank cycle.
2. Place the ignition in the START position and release it when the engine starts.

3. If the engine fails to start within 10 seconds, place the ignition in the OFF position, wait 10 to 15 seconds to allow the starter to cool, then repeat the “Extended Park Starting” procedure.
4. If the engine fails to start after eight attempts, allow the starter to cool for at least 10 minutes, then repeat the procedure.

**CAUTION!**

To prevent damage to the starter, do not crank continuously for more than 10 seconds at a time. Wait 10 to 15 seconds before trying again.

**IF ENGINE FAILS TO START**

If the engine fails to start after you have followed the “Normal Starting” or “Extreme Cold Weather” procedure, and the vehicle has not experience an extended park condition, it may be flooded. Push the accelerator pedal all the way to the floor and hold it there. Crank the engine for no more than 10 to 15 seconds. This should clear any excess fuel in case the engine is flooded. Leave the ignition in the RUN position, release the accelerator pedal and repeat the “Normal Starting” procedure.

**WARNING!**

- Never pour fuel or other flammable liquid into the throttle body air inlet opening in an attempt to start the vehicle. This could result in flash fire causing serious personal injury.
- Do not attempt to push or tow your vehicle to get it started. Vehicles equipped with an automatic transmission cannot be started this way. Unburned fuel could enter the catalytic converter and once the engine has started, ignite and damage the converter and vehicle.
- If the vehicle has a discharged battery, booster cables may be used to obtain a start from a booster battery or the battery in another vehicle. This type of start can be dangerous if done improperly → page 338.

**CAUTION!**

To prevent damage to the starter, do not continuously crank the engine for more than 10 to 15 seconds at a time. Wait 10 to 15 seconds before trying again.

**AFTER STARTING**

The idle speed is controlled automatically and will decrease as the engine warms up.

**STARTING THE ENGINE — DIESEL ENGINE (IF EQUIPPED)**

Before starting your vehicle, adjust your seat, both inside and outside mirrors, and fasten your seat belts.

The starter is allowed to crank for up to 25-second intervals. Waiting two minutes between such intervals will protect the starter from overheating.

**WARNING!**

- Before exiting a vehicle, always come to a complete stop, then shift the automatic transmission into PARK and apply the parking brake.
- Always make sure the ignition is in the OFF position, key fob is removed from the vehicle and vehicle is locked.

*(Continued)*



**WARNING!**

- Never leave children alone in a vehicle, or with access to an unlocked vehicle. Leaving children in a vehicle unattended is dangerous for a number of reasons. A child or others could be seriously or fatally injured. Children should be warned not to touch the parking brake, brake pedal or the gear selector.
- Do not leave the key fob in or near the vehicle, or in a location accessible to children, and do not leave the ignition of a vehicle equipped with Keyless Enter 'n Go™ in the ACC or ON/RUN position. A child could operate power windows, other controls, or move the vehicle.
- Do not leave children or animals inside parked vehicles in hot weather. Interior heat build-up may cause serious injury or death.

**NOTE:**

Engine start up in very low ambient temperature could result in evident white smoke. This condition will disappear as the engine warms up.

**CAUTION!**

- The engine is allowed to crank as long as 25 seconds. If the engine fails to start during this period, please wait at least two minutes for the starter to cool before repeating start procedure.
- If the Water in Fuel Indicator Light remains on, DO NOT START engine before you drain the water from the fuel filters to avoid engine damage → page 362.

**AUTOMATIC TRANSMISSION**

Start the engine with the transmission gear selector in the PARK (P) position. Apply the brake before shifting to any driving range.

**EXTREME COLD WEATHER**

The cartridge block heater clips into the engine block near the water jacket and transfers heat to the coolant. It requires a 110–115 Volt AC electrical outlet with a grounded, three-wire extension cord. Its use is recommended for environments that routinely fall below -10°F (-23°C). It should be used when the vehicle has not been running overnight or longer periods and should be plugged in for two hours prior to start. Its use is required for cold starts with temperatures under -20°F (-28°C).

**NOTE:**

The engine block heater and heater cord are factory-installed options. If your vehicle is not equipped, heater and heater cords are available from an authorized Mopar® dealer.

- A 12 Volt heater built into the fuel filter housing aids in preventing fuel gelling. It is controlled by a built-in thermostat.
- A Diesel Pre-Heat system both improves engine starting and reduces the amount of white smoke generated by a warming engine.

**NORMAL STARTING**

Observe the instrument cluster lights when starting the engine.

**NOTE:**

Normal starting of either a cold or a warm engine is obtained without pumping or pressing the accelerator pedal.

1. Always apply the parking brake.
2. Press and hold the brake pedal while pushing the ENGINE START/STOP button once.

**NOTE:**

A delay of the start of up to five seconds is possible under very cold conditions. The Wait to Start telltale will be illuminated during the preheat process. When the engine Wait To Start telltale goes off the engine will automatically crank.

**CAUTION!**

If the Water in Fuel Indicator Light remains on, **DO NOT START** the engine before you drain the water from the fuel filters to avoid engine damage → page 362.

3. The system will automatically engage the starter to crank the engine. If the vehicle fails to start, the starter will disengage automatically after 25 seconds.
4. If you wish to stop the cranking of the engine prior to the engine starting, push the ENGINE START/STOP button again.
5. Check that the Oil Pressure Warning Light has turned off.
6. Release the parking brake.

**STARTING FLUIDS**

The engine is equipped with a glow plug preheating system. If the instructions in this manual are followed, the engine should start in all conditions and no type of starting fluid should be used.

**WARNING!**

- Do not leave children or animals inside parked vehicles in hot weather. Interior heat build-up may cause serious injury or death.
- When leaving the vehicle, always make sure the keyless ignition node is in the OFF position, remove the key fob from the vehicle and lock the vehicle.
- Never leave children alone in a vehicle, or with access to an unlocked vehicle. Allowing children to be in a vehicle unattended is dangerous for a number of reasons. A child or others could be seriously or fatally injured. Children should be warned not to touch the parking brake, brake pedal or the gear selector.
- Do not leave the key fob in or near the vehicle, or in a location accessible to children, and do not leave the ignition of a vehicle equipped with Keyless Enter 'n Go™ in the ACC or ON/RUN position. A child could operate power windows, other controls, or move the vehicle.

**NORMAL OPERATION — DIESEL ENGINE**

Observe the following when the diesel engine is operating:

- All message center lights are off.
- Malfunction Indicator Light (MIL) is off.
- Engine Oil Pressure telltale is not illuminated.
- Voltmeter operation.

The voltmeter may show a gauge fluctuation at various engine temperatures. This is caused by the glow plug heating system. The number of cycles and the length of the cycling operation is controlled by the engine control module. Glow plug heater operation can run for several minutes. Once the heater operation is complete, the voltmeter needle will stabilize.

## COLD WEATHER PRECAUTIONS

Operation in ambient temperature below 32 °F (0 °C) may require special considerations. The following charts suggest these options:

### Fuel Operating Range

#### NOTE:

Use Ultra Low Sulfur Diesel (ULSD) Fuels **ONLY**.

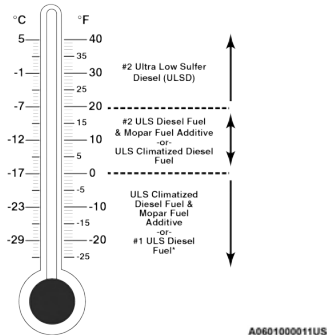

Fuel Operating Range Chart

\*Number 1 ULSD Fuel should only be used where extended arctic conditions 0 °F (-18 °C) exist.

#### NOTE:

- Use of Climatized ULSD Fuel or Number 1 ULSD Fuel results in a noticeable decrease in fuel economy.
- Climatized ULSD Fuel is a blend of Number 2 ULSD Fuel and Number 1 ULSD Fuel which reduces the temperature at which wax crystals form in fuel.
- The fuel grade should be clearly marked on the pump at the fuel station.
- The engine requires the use of Ultra Low Sulfur Diesel Fuel. Use of incorrect fuel could result in engine and exhaust system damage  
↪ page 420.
- If climatized or Number 1 ULSD Fuel is not available, and you are operating below 20 °F (-6 °C), in sustained arctic conditions, Mopar® Premium Diesel Fuel Treatment (or equivalent) is recommended to avoid gelling (see Fuel Operating Range Chart).

### Engine Oil Usage

See Engine Fluids and Lubricants for the correct engine oil viscosity ↪ page 424.

### Winter Front Cover

A Winter front or cold weather cover can be used in ambient temperatures below 32 °F (0 °C), especially during extended idle conditions. This cover is equipped with four flaps for managing

total grille opening in varying ambient temperatures. If a Winter front or cold weather cover is to be used, the flaps should be in the full open position to allow air flow to the cooling module and automatic transmission oil cooler. When ambient temperatures drop below 0 °F (-17 °C) the four flaps need to be closed. A suitable cold weather cover is available from a Mopar® dealer.

### Engine Warm-Up

Avoid full throttle operation when the engine is cold. When starting a cold engine, bring the engine up to operating speed slowly to allow the oil pressure to stabilize as the engine warms up.

If temperatures are below 32 °F (0 °C), operate the engine at moderate speeds for five minutes before full loads are applied.

### ENGINE IDLING

Avoid prolonged idling. Long periods of idling may be harmful to your engine because combustion chamber temperatures can drop so low that the fuel may not burn completely. Incomplete combustion allows carbon and varnish to form on piston rings, cylinder head valves, and injector nozzles. Also, the unburned fuel can enter the crankcase, diluting the oil and causing rapid wear to the engine.

## STOPPING THE ENGINE

After full load operation, idle the engine for a few minutes before shutting it down. This idle period will allow the lubricating oil and coolant to carry excess heat away from the turbocharger.

### NOTE:

Refer to the following chart for proper engine shutdown.

Driving Condition	Load	Turbocharger Temperature	Idle Time (min.) Before Engine Shutdown
Stop and Go	Empty	Cool	None
Stop and Go	Medium		0.5
Highway Speeds	Medium	Warm	1.0
City Traffic	Maximum GCWR		1.5
Highway Speeds	Maximum GCWR		2.0
Uphill Grade	Maximum GCWR	Hot	2.5

### NOTE:

Under certain conditions the engine fan will run after the engine is turned off. These conditions are under high load and high temperature conditions.

## COOLING SYSTEM TIPS — AUTOMATIC TRANSMISSION

To reduce the potential for engine and transmission overheating in high ambient temperature conditions, take the following actions:

- City Driving — When stopped, shift the transmission into NEUTRAL (N) and increase engine idle speed.
- Highway Driving — Reduce your speed.
- Up Steep Hills — Select a lower transmission gear.
- Air Conditioning — Turn it off temporarily.

### NOTE:

If the coolant temperature is too high, the A/C will automatically turn off.

## Do Not Operate The Engine With Low Oil Pressure

If the Oil Pressure Warning Light turns on while driving, stop the vehicle and shut down the engine as soon as possible. A chime will sound when the light turns on. After the vehicle is safely stopped, restart the engine and monitor the Oil Pressure Warning Light. If the Oil Pressure Warning Light is still illuminated, turn the engine OFF and contact an authorized dealer for further assistance. If the

lamp is no longer illuminated, the engine can be operated but it is recommended to take the vehicle to an authorized dealer as soon as possible.

#### NOTE:

Do not operate the vehicle until the cause is corrected. This light does not show how much oil is in the engine. The engine oil level must be checked under the hood.

#### CAUTION!

If oil pressure falls to less than normal readings, shut the engine off immediately. Failure to do so could result in immediate and severe engine damage.

### Do Not Operate The Engine With Failed Parts

All engine failures give some warning before the parts fail. Be on the alert for changes in performance, sounds, and visual evidence that the engine requires service. Some important clues are:

- Engine misfiring or vibrating severely
- Sudden loss of power
- Unusual engine noises
- Fuel, oil or coolant leaks

- Sudden change, outside the normal operating range, in the engine operating temperature
- Excessive smoke
- Oil pressure drop

### ENGINE BREAK-IN RECOMMENDATIONS — GASOLINE ENGINE (IF EQUIPPED)

A long break-in period is not required for the engine and drivetrain (transmission and axle) in your vehicle.

Drive moderately during the first 300 miles (500 km). After the initial 60 miles (100 km), speeds up to 50 or 55 mph (80 or 90 km/h) are desirable.

While cruising, brief full-throttle acceleration within the limits of local traffic laws contributes to a good break-in. Wide-open throttle acceleration in low gear can be detrimental and should be avoided.

The engine oil installed in the engine at the factory is a high-quality energy conserving type lubricant. Oil changes should be consistent with anticipated climate conditions under which vehicle operations will occur.

For the recommended viscosity and quality grades  
 ☞ page 424.

#### CAUTION!

Never use Non-Detergent Oil or Straight Mineral Oil in the engine or damage may result.

#### NOTE:

A new engine may consume some oil during its first few thousand miles (kilometers) of operation. This should be considered a normal part of the break-in and not interpreted as a problem.

### ENGINE BREAK-IN RECOMMENDATIONS — DIESEL ENGINE (IF EQUIPPED)

The diesel engine does not require a break-in period due to its construction. Normal operation is allowed, providing the following recommendations are followed:

- Warm up the engine before placing it under load.
- Do not operate the engine at idle for prolonged periods.
- Use the appropriate transmission gear to prevent engine lugging.
- Observe vehicle oil pressure and temperature indicators.

- Check the coolant and oil levels frequently.
- Vary throttle position at highway speeds when carrying or towing significant weight.

**NOTE:**

Light duty operation such as light trailer towing or no load operation will extend the time before the engine is at full efficiency. Reduced fuel economy and power may be seen at this time.

The engine oil installed in the engine at the factory is a high-quality energy conserving type lubricant. Oil changes should be consistent with anticipated climate conditions under which vehicle operations will occur. For recommended viscosity and quality grades see [page 424](#). NON-DETERGENT OR STRAIGHT MINERAL OILS MUST NEVER BE USED.

**PARKING BRAKE**

Before exiting the vehicle, make sure that the parking brake is fully applied. Also, be certain to leave an automatic transmission in PARK, or manual transmission in REVERSE or FIRST gear.

The parking brake lever is located in the center console. To apply the parking brake, pull the lever up as firmly as possible. To release the parking brake, pull the lever up slightly, push the center button, then lower the lever completely.

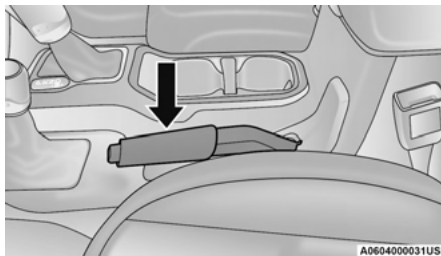
**Parking Brake Lever**

When the parking brake is applied with the ignition switch ON, the Brake Warning Light in the instrument cluster will illuminate.

**NOTE:**

- When the parking brake is applied and the automatic transmission is placed in gear, the Brake Warning Light will flash. If vehicle speed is detected, a chime will sound to alert the driver. Fully release the parking brake before attempting to move the vehicle.
- This light only shows that the parking brake is applied. It does not show the degree of brake application.

When parking on a hill, it is important to turn the front wheels toward the curb on a downhill grade and away from the curb on an uphill grade. For vehicles equipped with an automatic transmission, apply the parking brake before placing the gear selector in PARK, otherwise the load on the transmission locking mechanism may make it difficult to move the gear selector out of PARK.

**WARNING!**

- Never use the PARK position on an automatic transmission as a substitute for the parking brake. Always apply the parking brake fully when parked to guard against vehicle movement and possible injury or damage.
- When exiting the vehicle, always remove the key fob from the ignition and lock your vehicle.
- Never leave children alone in a vehicle, or with access to an unlocked vehicle. Allowing children to be in a vehicle unattended is dangerous for a number of reasons. A child or others could be seriously or fatally injured. Children should be warned not to touch the parking brake, brake pedal or the gear selector.

*(Continued)*

**WARNING!**

- Do not leave the key fob in or near the vehicle, or in a location accessible to children. A child could operate power windows, other controls, or move the vehicle.
- Be sure the parking brake is fully disengaged before driving; failure to do so can lead to brake failure and a collision.
- Always fully apply the parking brake when leaving your vehicle or it may roll and cause damage or injury. Also, be certain to leave an automatic transmission in PARK, a manual transmission in REVERSE or FIRST gear. Failure to do so may cause the vehicle to roll and cause damage or injury.

**CAUTION!**

If the Brake Warning Light remains on with the parking brake released, a brake system malfunction is indicated. Have the brake system serviced by an authorized dealer immediately.

**MANUAL TRANSMISSION — IF EQUIPPED****WARNING!**

You or others could be injured if you leave the vehicle unattended without having the parking brake fully applied. The parking brake should always be applied when the driver is not in the vehicle, especially on an incline.

**CAUTION!**

- Never drive with your foot resting on or partially depressing the clutch pedal. Never attempt to hold the vehicle on a hill with the clutch pedal partially engaged. Operating vehicle in this manner may cause the clutch to overheat and cause permanent damage to the clutch. If you continue to operate the vehicle in this manner, the “CLUTCH HOT” message or Transmission Temperature Warning Light will be displayed in the instrument cluster. For more information ↪ page 128.

(Continued)

**CAUTION!**

- Do not drive with your hand resting on the gear selector as the force exerted, even if slight, could lead over time to premature wear of the gearbox internal components.

**NOTE:**

During cold weather, you may experience increased effort in shifting until the transmission fluid warms up. This is normal.

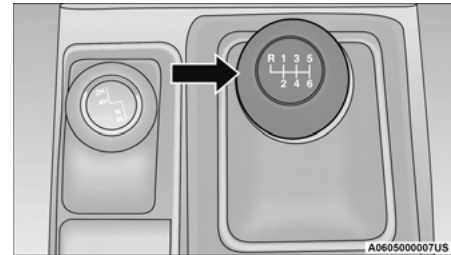

**Transmission Gear Selector**

To shift the gears, fully press the clutch pedal and place the gear selector into the desired gear position (the diagram for the engagement of the gears is displayed on the handle of the selector). The engaged gear will be displayed in the instrument cluster.

To engage REVERSE gear from the NEUTRAL position, lift the REVERSE ring, located below the knob and move the gear selector all the way left and then forward.

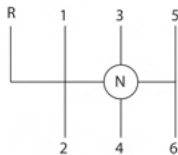

Shift Pattern

0508100334US

## SHIFTING

Fully press the clutch pedal before shifting gears. As you release the clutch pedal, lightly press the accelerator pedal.

You should always use FIRST gear when starting from a standing position.

## NOTE:

A certain amount of noise from the transmission is normal. This noise can be most noticeable when the vehicle is idling in NEUTRAL with the clutch engaged (clutch pedal released), but it may also be heard when driving. The noise may also be more noticeable when the transmission is warm. This noise is normal and is not an indication of a problem with your clutch or transmission.

## Recommended Vehicle Shift Speeds

To utilize your manual transmission efficiently for both fuel economy and performance, it should be upshifted as listed in recommended shift speed chart. Shift at the vehicle speeds listed for acceleration. When heavily loaded or pulling a trailer, these recommended up-shift speeds may not apply.

Manual Transmission Shift Speeds in MPH (KM/H)						
Engine	Speeds	1 to 2	2 to 3	3 to 4	4 to 5	5 to 6
3.6L	Accel.	15 (24)	24 (39)	50 (80)	65 (104)	70 (112)
	Cruise	10 (16)	19 (31)	40 (64)	55 (88)	65 (105)

## NOTE:

Vehicle speeds shown in the chart above are for 2H and 4H only. Vehicle speeds in 4L would be significantly less.



## DOWNSHIFTING

Moving from a high gear down to a lower gear is recommended to preserve brakes when driving down steep hills. In addition, downshifting at the right time provides better acceleration when you desire to resume speed. Downshift progressively. Do not skip gears to avoid overspeeding the engine and clutch.

### NOTE:

The manual transmission shift system is equipped with gear blockers, which will prevent downshifts into FIRST or SECOND gear above certain vehicle speeds.

### WARNING!

Do not downshift for additional engine braking on a slippery surface. The drive wheels could lose their grip, and the vehicle could skid.

### CAUTION!

- Skipping gears and downshifting into lower gears at higher vehicle speeds can damage the engine and clutch systems. Any attempt to shift into lower gear with clutch pedal pressed may result damage to the clutch system. Shifting into lower gear and releasing the clutch may result in engine damage.

*(Continued)*

### CAUTION!

- When descending a hill, be very careful to downshift one gear at a time to prevent overspeeding the engine which can cause engine damage, and/or clutch damage, even if the clutch pedal is pressed. If transfer case is in low range the vehicle speeds to cause engine and clutch damage are significantly lower.
- Failure to follow the maximum recommended downshifting speeds may cause the engine damage and/or damage the clutch, even if the clutch pedal is pressed.
- Descending a hill in low range with clutch pedal pressed could result in clutch damage.

## Maximum Recommended Downshift Speeds

### CAUTION!

Failure to follow the maximum recommended downshifting speeds may cause the engine to overspeed and/or damage the clutch disc, even if the clutch pedal is pressed.

### Manual Transmission Downshift Speeds in MPH (KM/H)

Gear Selection	6 to 5	5 to 4	4 to 3	3 to 2	2 to 1
Maximum Speed	80 (129)	70 (113)	50 (81)	30 (48)	15 (24)

### NOTE:

Vehicle speeds shown in the chart above are for 2H and 4H only, vehicle speeds in 4L would be significantly less.

## AUTOMATIC TRANSMISSION — IF EQUIPPED

You must press and hold the brake pedal while shifting out of PARK.

### WARNING!

- Never use the PARK position as a substitute for the parking brake. Always apply the parking brake fully when exiting the vehicle to guard against vehicle movement and possible injury or damage.

*(Continued)*

**WARNING!**

- Your vehicle could move and injure you and others if it is not in PARK. Check by trying to move the transmission gear selector out of PARK with the brake pedal released. Make sure the transmission is in PARK before exiting the vehicle.
- The transmission may not engage PARK if the vehicle is moving. Always bring the vehicle to a complete stop before shifting to PARK, and verify that the transmission gear position indicator solidly indicates PARK (P) without blinking. Ensure that the vehicle is completely stopped, and the PARK position is properly indicated, before exiting the vehicle.
- It is dangerous to shift out of PARK or NEUTRAL if the engine speed is higher than idle speed. If your foot is not firmly pressing the brake pedal, the vehicle could accelerate quickly forward or in reverse. You could lose control of the vehicle and hit someone or something. Only shift into gear when the engine is idling normally and your foot is firmly pressing the brake pedal.

*(Continued)***WARNING!**

- Unintended movement of a vehicle could injure those in or near the vehicle. As with all vehicles, you should never exit a vehicle while the engine is running. Before exiting a vehicle, always come to a complete stop, then apply the parking brake, shift the transmission into PARK, and turn the ignition OFF. When the ignition is in the OFF position, the transmission is locked in PARK, securing the vehicle against unwanted movement.
- When exiting the vehicle, always make sure the ignition is in the OFF position, remove the key fob from the vehicle, and lock the vehicle.
- Never leave children alone in a vehicle, or with access to an unlocked vehicle. Allowing children to be in a vehicle unattended is dangerous for a number of reasons. A child or others could be seriously or fatally injured. Children should be warned not to touch the parking brake, brake pedal or the transmission gear selector.
- Do not leave the key fob in or near the vehicle (or in a location accessible to children), and do not leave the ignition in the ACC or ON/RUN position. A child could operate power windows, other controls, or move the vehicle.

**CAUTION!**

Damage to the transmission may occur if the following precautions are not observed:

- Shift into or out of PARK or REVERSE only after the vehicle has come to a complete stop.
- Do not shift between PARK, REVERSE, NEUTRAL, or DRIVE when the engine is above idle speed.
- Before shifting into any gear, make sure your foot is firmly pressing the brake pedal.

**IGNITION PARK INTERLOCK**

This vehicle is equipped with an Ignition Park Interlock which requires the transmission to be in PARK before the ignition can be turned to the OFF position. This helps the driver avoid inadvertently leaving the vehicle without placing the transmission in PARK. This system also locks the transmission in PARK whenever the ignition is in the OFF position.

**NOTE:**

The transmission is NOT locked in PARK when the ignition is in the ACC position (even though the engine will be off). Ensure that the transmission is in PARK, and the ignition is **OFF** (not in ACC position) before exiting the vehicle.

## BRAKE/TRANSMISSION SHIFT INTERLOCK (BTSI) SYSTEM

This vehicle is equipped with a BTSI system that holds the transmission gear selector in PARK unless the brakes are applied. To shift the transmission out of PARK, the engine must be running and the brake pedal must be pressed. The brake pedal must also be pressed to shift from NEUTRAL into DRIVE or REVERSE when the vehicle is stopped or moving at low speeds.

## 8-SPEED AUTOMATIC TRANSMISSION

The transmission gear range (PRNDM) is displayed both beside the gear selector and in the instrument cluster. To select a gear range, push the lock button on the gear selector and move the selector rearward or forward. To shift the transmission out of PARK, the engine must be running and the brake pedal must be pressed. You must also press the brake pedal to shift from NEUTRAL into DRIVE or REVERSE when the vehicle is stopped or moving at low speeds. Select the DRIVE range for normal driving.

### NOTE:

In the event of a mismatch between the gear selector position and the actual transmission gear (for example, driver selects PARK while driving),

the position indicator will blink continuously until the selector is returned to the proper position, or the requested shift can be completed.

The electronically controlled transmission adapts its shift schedule based on driver inputs, along with environmental and road conditions. The transmission electronics are self-calibrating; therefore, the first few shifts on a new vehicle may be somewhat abrupt. This is a normal condition, and precision shifts will develop within a few hundred miles (kilometers).

Only shift from DRIVE to PARK or REVERSE when the accelerator pedal is released and the vehicle is stopped. Be sure to keep your foot on the brake pedal when shifting between these gears.

The transmission gear selector provides PARK, REVERSE, NEUTRAL, DRIVE and MANUAL (AutoStick) shift positions. Manual shifts can be made using the AutoStick shift control. Toggling the gear selector forward (-) or rearward (+) while in the MANUAL (AutoStick) position (beside the DRIVE position) will manually select the transmission gear, and will display the current gear in the instrument cluster ↗ page 156.

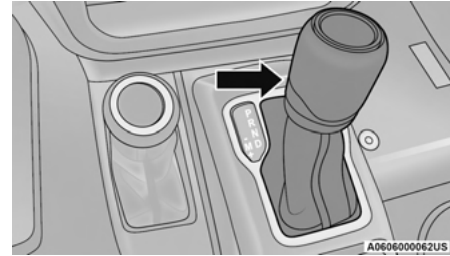

Transmission Gear Selector

4

### NOTE:

If the gear selector cannot be moved to the PARK, REVERSE, or NEUTRAL position (when pushed forward), it is probably in the AutoStick (+/-) position (beside the DRIVE position). In AutoStick mode, the transmission gear (1, 2, 3, etc.) is displayed in the instrument cluster. Move the gear selector to the right (into the DRIVE [D] position) for access to PARK, REVERSE, and NEUTRAL.

### Gear Ranges

Do not press the accelerator pedal when shifting out of PARK or NEUTRAL.

### NOTE:

After selecting any gear range, wait a moment to allow the selected gear to engage before accelerating. This is especially important when the engine is cold.

**PARK (P)**

This range supplements the parking brake by locking the transmission. The engine can be started in this range. Never attempt to use PARK while the vehicle is in motion. Apply the parking brake when exiting the vehicle in this range.

When parking on a hill, apply the parking brake before shifting the transmission to PARK. As an added precaution, turn the front wheels toward the curb on a downhill grade and away from the curb on an uphill grade.

When exiting the vehicle, always:

- Apply the parking brake.
- Shift the transmission into PARK.
- Turn the ignition OFF.
- Remove the key fob from the vehicle.

**NOTE:**

On four-wheel drive vehicles, be sure that the transfer case is in a drive position.

**WARNING!**

- Never use the PARK position as a substitute for the parking brake. Always apply the parking brake fully when exiting the vehicle to guard against vehicle movement and possible injury or damage.

*(Continued)*

**WARNING!**

- Your vehicle could move and injure you and others if it is not in PARK. Check by trying to move the transmission gear selector out of PARK with the brake pedal released. Make sure the transmission is in PARK before exiting the vehicle.
- The transmission may not engage PARK if the vehicle is moving. Always bring the vehicle to a complete stop before shifting to PARK, and verify that the transmission gear position indicator solidly indicates PARK (P) without blinking. Ensure that the vehicle is completely stopped, and the PARK position is properly indicated, before exiting the vehicle.
- It is dangerous to shift out of PARK or NEUTRAL if the engine speed is higher than idle speed. If your foot is not firmly pressing the brake pedal, the vehicle could accelerate quickly forward or in reverse. You could lose control of the vehicle and hit someone or something. Only shift into gear when the engine is idling normally and your foot is firmly pressing the brake pedal.

*(Continued)*

**WARNING!**

- Unintended movement of a vehicle could injure those in or near the vehicle. As with all vehicles, you should never exit a vehicle while the engine is running. Before exiting a vehicle, always come to a complete stop, then apply the parking brake, shift the transmission into PARK, and turn the ignition OFF. When the ignition is in the OFF position, the transmission is locked in PARK, securing the vehicle against unwanted movement.
- When exiting the vehicle, always make sure the ignition is in the OFF position, remove the key fob from the vehicle, and lock the vehicle.
- Never leave children alone in a vehicle, or with access to an unlocked vehicle. Allowing children to be in a vehicle unattended is dangerous for a number of reasons. A child or others could be seriously or fatally injured. Children should be warned not to touch the parking brake, brake pedal or the transmission gear selector.
- Do not leave the key fob in or near the vehicle (or in a location accessible to children), and do not leave the ignition in the ACC or ON/RUN position. A child could operate power windows, other controls, or move the vehicle.

**CAUTION!**

- Before moving the transmission gear selector out of PARK, you must start the engine, and also press the brake pedal. Otherwise, damage to the gear selector could result.
- DO NOT race the engine when shifting from PARK or NEUTRAL into another gear range, as this can damage the drivetrain.

The following indicators should be used to ensure that you have properly engaged the transmission into the PARK position:

- When shifting into PARK, push the lock button on the gear selector and firmly move the gear selector all the way forward until it stops and is fully seated.
- Look at the transmission gear position display and verify that it indicates the PARK position (P), and is not blinking.
- With the brake pedal released, verify that the gear selector will not move out of PARK.

**REVERSE (R)**

This range is for moving the vehicle backward. Shift into REVERSE only after the vehicle has come to a complete stop.

**NEUTRAL (N)**

Use this range when the vehicle is standing for prolonged periods with the engine running. Apply the parking brake and shift the transmission into PARK if you must exit the vehicle.

**WARNING!**

Do not coast in NEUTRAL and never turn off the ignition to coast down a hill. These are unsafe practices that limit your response to changing traffic or road conditions. You might lose control of the vehicle and have a collision.

**CAUTION!**

- Towing the vehicle, coasting, or driving for any other reason with the transmission in NEUTRAL can cause severe transmission damage.
- For Recreational Towing ⇨ page 198.
- For Towing A Disabled Vehicle ⇨ page 344.

**DRIVE (D)**

This range should be used for most city and highway driving. It provides the smoothest upshifts and downshifts, and the best fuel economy. The transmission automatically upshifts through all

forward gears. The DRIVE position should be used for all normal operating conditions.

When frequent transmission shifting occurs (such as when operating the vehicle under heavy loading conditions, in hilly terrain, traveling into strong head winds, or while towing a heavy trailer), use the AutoStick shift control to select a lower gear ⇨ page 156. Under these conditions, using a lower gear will improve performance and extend transmission life by reducing excessive shifting and heat build-up.

During extremely cold temperatures (-22°F [-30°C] or below), transmission operation may be modified depending on engine and transmission temperature as well as vehicle speed. Normal operation will resume once the transmission temperature has risen to a suitable level.

**MANUAL (M)**

The MANUAL (M, +/-) position (beside the DRIVE position) enables full manual control of transmission shifting also known as AutoStick mode. Toggling the gear selector forward (-) or rearward (+) while in the MANUAL (AutoStick) position will manually select the transmission gear, and will display the current gear in the instrument cluster ⇨ page 156.

## Transmission Limp Home Mode

Transmission function is monitored electronically for abnormal conditions. If a condition is detected that could result in transmission damage, Transmission Limp Home mode is activated. In this mode, the transmission may operate only in certain gears, or may not shift at all. Vehicle performance may be severely degraded and the engine may stall. In some situations, the transmission may not re-engage if the engine is turned off and restarted. The Malfunction Indicator Light (MIL) may be illuminated. A message in the instrument cluster will inform the driver of the more serious conditions, and indicate what actions may be necessary.

In the event of a momentary problem, the transmission can be reset to regain all forward gears by performing the following steps:

### NOTE:

- In cases where the instrument cluster message indicates the transmission may not re-engage after engine shutdown, perform this procedure only in a desired location (preferably, at an authorized dealer).
- Even if the transmission can be reset, we recommend that you visit an authorized dealer at your earliest possible convenience. An authorized dealer has diagnostic equipment to assess the condition of your transmission.

- If the transmission cannot be reset, authorized dealer service is required.

1. Stop the vehicle.
2. Shift the transmission into PARK, if possible. If not, shift the transmission to NEUTRAL.
3. Push and hold the ignition switch until the engine turns off.
4. Wait approximately 30 seconds.
5. Restart the engine.
6. Shift into the desired gear range. If the problem is no longer detected, the transmission will return to normal operation.

## AutoStick

AutoStick is a driver-interactive transmission feature providing manual shift control, giving you more control of the vehicle. AutoStick allows you to maximize engine braking, eliminate undesirable upshifts and downshifts, and improve overall vehicle performance. This feature can also provide you with more control during passing, city driving, cold slippery conditions, mountain driving, trailer towing, and many other situations.

### Operation

To activate AutoStick mode, move the gear selector into the MANUAL (M) position (beside the DRIVE position). The current transmission gear will be displayed in the instrument cluster. In AutoStick

mode, you can use the gear selector (in the MANUAL position) to manually shift the transmission.

AutoStick mode has the following operational benefits:

- The transmission will automatically downshift as the vehicle slows (to prevent engine lugging) and will display the current gear.
- The transmission will automatically downshift to FIRST gear when coming to a stop. After a stop, the driver should manually upshift (+) the transmission as the vehicle is accelerated.
- You can start out, from a stop, in FIRST or SECOND gear (or THIRD gear, in 4L range). Tapping (+) (at a stop) will allow starting in SECOND gear. Starting out in SECOND or THIRD gear can be helpful in snowy or icy conditions.
- If a requested downshift would cause the engine to overspeed, that shift will not occur.
- The system will ignore attempts to upshift at too low of a vehicle speed.
- Holding the gear selector in the (-) position will downshift the transmission to the lowest gear possible at the current speed.
- Transmission shifting will be more noticeable when AutoStick is enabled.
- The system may revert to automatic shift mode if a fault or overheat condition is detected.

**NOTE:**

When Hill Descent Control is enabled, AutoStick is not active.

To disengage AutoStick mode, return the gear selector to the DRIVE position. You can shift in or out of the AutoStick position at any time without taking your foot off the accelerator pedal.

**WARNING!**

Do not downshift for additional engine braking on a slippery surface. The drive wheels could lose their grip and the vehicle could skid, causing a collision or personal injury.

**FOUR-WHEEL DRIVE OPERATION****WARNING!**

Failure to engage a transfer case position completely can cause transfer case damage or loss of power and vehicle control. You could have a collision. Do not drive the vehicle unless the transfer case is fully engaged.

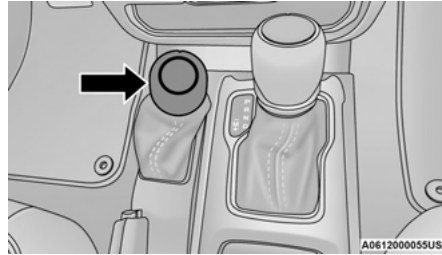
**FOUR-POSITION TRANSFER CASE —  
IF EQUIPPED**

**Four-Wheel Drive Gear Selector**

The transfer case provides four positions:

- 2H — Two-Wheel Drive High Range
- 4H — Four-Wheel Drive High Range
- N (Neutral)
- 4L — Four-Wheel Drive Low Range

For additional information on the appropriate use of each transfer case position, see the following:

**2H**

Two-Wheel Drive High Range — This range is for normal street and highway driving on dry, hard surfaced roads.

**4H**

Four-Wheel Drive High Range — This range maximizes torque to the front driveshaft, forcing the front and rear wheels to rotate at the same speed. This range provides additional traction for loose, slippery road surfaces only.

**N (Neutral)****WARNING!**

You or others could be injured or killed if you leave the vehicle unattended with the transfer case in the (N) Neutral position without first fully engaging the parking brake. The transfer case (N) Neutral position disengages both the front and rear driveshafts from the powertrain, and will allow the vehicle to roll, even if the automatic transmission is in PARK (or manual transmission is in gear). The parking brake should always be applied when the driver is not in the vehicle.

N (Neutral) — This range disengages both the front and rear driveshafts from the powertrain. To be used for flat towing behind another vehicle  
 ⇨ page 198.

**4L**

Four-Wheel Drive Low Range — This range provides low speed four-wheel drive. It maximizes torque to the front driveshaft, forcing the front and rear wheels to rotate at the same speed. This range provides additional traction and maximum pulling power for loose, slippery road surfaces only. Do not exceed 25 mph (40 km/h).

The transfer case is intended to be driven in the 2H position for normal street and highway conditions, such as hard-surfaced roads.

In the event that additional traction is required, the transfer case 4H and 4L positions can be used to lock the front and rear driveshafts together, forcing the front and rear wheels to rotate at the same speed. The 4H and 4L positions are intended for loose, slippery road surfaces only and not intended for normal driving. Driving in the 4H and 4L positions on hard-surfaced roads will cause increased tire wear and damage to the driveline components. For further information on shifting into 4H or 4L → page 158.

The instrument cluster alerts the driver that the vehicle is in four-wheel drive, and the front and rear driveshafts are locked together. The light will illuminate when the transfer case is shifted into the 4H position.

When operating your vehicle in 4L, the engine speed will be approximately three times (four times for Rubicon models) that of the 2H or 4H positions

at a given road speed. Take care not to overspeed the engine.

Proper operation of four-wheel drive vehicles depends on tires of equal size, type, and circumference on each wheel. Any difference will adversely affect shifting and cause damage to the transfer case.

Because four-wheel drive provides improved traction, there is a tendency to exceed safe turning and stopping speeds. Do not go faster than road conditions permit.

**Shifting Procedures****2H TO 4H OR 4H TO 2H**

Shifting between 2H and 4H can be made with the vehicle stopped or in motion. The preferred shifting speed would be 0 to 45 mph (72 km/h). With the vehicle in motion, the transfer case will engage/disengage faster if you momentarily release the accelerator pedal after completing the shift. Do not accelerate while shifting the transfer case. Apply a constant force when shifting the transfer case lever.

**NOTE:**

- Do not attempt to make a shift while only the front or rear wheels are spinning. The front and rear driveshaft speeds must be equal for the shift to take place. Shifting while only the front or rear wheels are spinning can cause damage to the transfer case.

- Delayed shifts out of four-wheel drive may be experienced due to uneven tire wear, low or uneven tire pressures, excessive vehicle loading, or cold temperatures.
- Shifting effort will increase with speed, this is normal.

During cold weather, you may experience increased effort in shifting until the transfer case fluid warms up. This is normal.

**4H TO 4L OR 4L TO 4H**

With the vehicle rolling at 1 to 3 mph (2 to 5 km/h), shift an automatic transmission into NEUTRAL (N), or press the clutch pedal on a manual transmission. While the vehicle is coasting at 1 to 3 mph (2 to 5 km/h), shift the transfer case lever firmly to the desired position. Do not pause with the transfer case in N (Neutral). Once the shift is completed, place the automatic transmission into DRIVE or release the clutch pedal on a manual transmission.

**NOTE:**

Shifting into or out of 4L is possible with the vehicle completely stopped; however, difficulty may occur due to the mating teeth not being properly aligned. Several attempts may be required for clutch teeth alignment and shift completion to occur. The preferred method is with the vehicle rolling at 1 to 3 mph (2 to 5 km/h). Avoid attempting to engage or disengage 4L with the vehicle moving faster than 1 to 3 mph (2 to 5 km/h).



During cold weather, you may experience increased effort in shifting until the transfer case fluid warms up. This is normal.

### WARNING!

Failure to engage a transfer case position completely can cause transfer case damage or loss of power and vehicle control. You could have a collision. Do not drive the vehicle unless the transfer case is fully engaged.

## FIVE-POSITION TRANSFER CASE — IF EQUIPPED

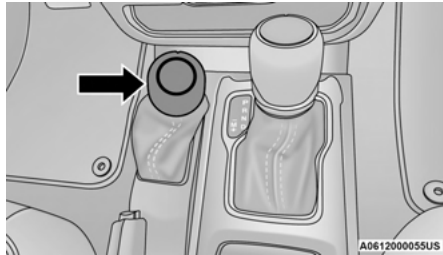

Four-Wheel Drive Gear Selector

The transfer case provides five mode positions:

- 2H — Two-Wheel Drive High Range
- 4H AUTO — Four-Wheel Drive Auto High Range
- 4H PART TIME — Four-Wheel Drive Part Time High Range
- N (Neutral)
- 4L — Four-Wheel Drive Low Range

For additional information on the appropriate use of each transfer case mode position, see the following:

### 2H

Two-Wheel Drive High Range — This range is for normal street and highway driving on dry, hard surfaced roads.

### 4H AUTO

Four-Wheel Drive Auto High Range — This range sends power to the front wheels. The four-wheel drive system will be automatically engaged when the vehicle senses a loss of traction. Additional traction for varying road conditions.

### 4H PART TIME

Four-Wheel Drive Part Time High Range — This range maximizes torque to the front driveshaft, forcing the front and rear wheels to rotate at the same speed. This range provides additional traction for loose, slippery road surfaces only.

### N (Neutral)

#### WARNING!

You or others could be injured or killed if you leave the vehicle unattended with the transfer case in the (N) Neutral position without first fully engaging the parking brake. The transfer case (N) Neutral position disengages both the front and rear driveshafts from the powertrain, and will allow the vehicle to roll, even if the automatic transmission is in PARK (or manual transmission is in gear). The parking brake should always be applied when the driver is not in the vehicle.

Neutral — This range disengages both the front and rear driveshafts from the powertrain. To be used for flat towing behind another vehicle ↗ page 198.

### 4L

Four-Wheel Drive Low Range — This range provides low speed four-wheel drive. It maximizes torque to the front driveshaft, forcing the front and rear wheels to rotate at the same speed. This range provides additional traction and maximum pulling power for loose, slippery road surfaces only. Do not exceed 25 mph (40 km/h).

This transfer case is designed to be driven in the two-wheel drive position (2H) or four-wheel drive position (4H AUTO) for normal street and highway

conditions on dry hard surfaced roads. Driving the vehicle in 2H will have greater fuel economy benefits as the front axle is not engaged in 2H.

For variable driving conditions, the 4H AUTO mode can be used. In this mode, the front axle is engaged, but the vehicle's power is sent to the rear wheels. Four-wheel drive will be automatically engaged when the vehicle senses a loss of traction. Because the front axle is engaged, this mode will result in lower fuel economy than the 2H mode.

In the event that additional traction is required, the transfer case 4H and 4L positions can be used to lock the front and rear driveshafts together, forcing the front and rear wheels to rotate at the same speed. The 4H and 4L positions are intended for loose, slippery road surfaces only and not intended for normal driving. Driving in the 4H and 4L positions on hard-surfaced roads will cause increased tire wear and damage to the driveline components. For further information on shifting into 4H or 4L ↪ page 160.

The instrument cluster alerts the driver that the vehicle is in four-wheel drive, and the front and rear driveshafts are locked together. The light will illuminate when the transfer case is shifted into the 4H position.

When operating your vehicle in 4L, the engine speed will be approximately three times (four times for Rubicon models) that of the 2H or 4H positions at a given road speed. Take care not to overspeed the engine.

Proper operation of four-wheel drive vehicles depends on tires of equal size, type, and circumference on each wheel. Any difference will adversely affect shifting and cause damage to the transfer case.

Because four-wheel drive provides improved traction, there is a tendency to exceed safe turning and stopping speeds. Do not go faster than road conditions permit.

## Shifting Procedures

### 2H TO 4H AUTO OR 4H AUTO TO 2H

Shifting between 2H and 4H AUTO can be made with the vehicle stopped or in motion. The preferred shifting speed would be 0 to 45 mph (72 km/h). With the vehicle in motion, the transfer case will engage/disengage faster if you momentarily release the accelerator pedal after completing the shift. Do not accelerate while shifting the transfer case. Apply a constant force when shifting the transfer case lever.

### 2H/4H AUTO TO 4H PART TIME OR 4H PART TIME TO 2H/4H AUTO

Shifting between 2H/4H AUTO to 4H PART TIME can be made with the vehicle stopped or in motion. The preferred shifting speed would be 0 to 45 mph (72 km/h). With the vehicle in motion, the transfer case will engage/disengage faster if you momentarily release the accelerator pedal after completing the shift. Do not accelerate while shifting the transfer case. Apply a constant force when shifting the transfer case lever.

#### NOTE:

- Do not attempt to make a shift while only the front or rear wheels are spinning. The front and rear driveshaft speeds must be equal for the shift to take place. Shifting while only the front or rear wheels are spinning can cause damage to the transfer case.
- Delayed shifts out of four-wheel drive may be experienced due to uneven tire wear, low or uneven tire pressures, excessive vehicle loading, or cold temperatures.
- Shifting effort will increase with speed, this is normal.

During cold weather, you may experience increased effort in shifting until the transfer case fluid warms up. This is normal.

#### 4H PART TIME/4H AUTO TO 4L OR 4L TO 4H PART TIME/4H AUTO

With the vehicle rolling at 1 to 3 mph (2 to 5 km/h), shift an automatic transmission into NEUTRAL (N), or press the clutch pedal on a manual transmission. While the vehicle is coasting at 1 to 3 mph (2 to 5 km/h), shift the transfer case lever firmly to the desired position. Do not pause with the transfer case in N (Neutral). Once the shift is completed, place the automatic transmission into DRIVE or release the clutch pedal on a manual transmission.

#### NOTE:

Shifting into or out of 4L is possible with the vehicle completely stopped; however, difficulty may occur due to the mating teeth not being properly aligned. Several attempts may be required for clutch teeth alignment and shift completion to occur. The preferred method is with the vehicle rolling at 1 to 3 mph (2 to 5 km/h). Avoid attempting to engage or disengage 4L with the vehicle moving faster than 1 to 3 mph (2 to 5 km/h).

#### WARNING!

Failure to engage a transfer case position completely can cause transfer case damage or loss of power and vehicle control. You could have a collision. Do not drive the vehicle unless the transfer case is fully engaged.

#### TRAC-LOK REAR AXLE — IF EQUIPPED

The Trac-Lok rear axle provides a constant driving force to both rear wheels and reduces wheel spin caused by the loss of traction at one driving wheel. If traction differs between the two rear wheels, the differential automatically proportions the usable torque by providing more torque to the wheel that has traction.

Trac-Lok is especially helpful during slippery driving conditions. With both rear wheels on a slippery surface, a slight application of the accelerator will supply maximum traction.

#### WARNING!

On vehicles equipped with a limited-slip differential, never run the engine with one rear wheel off the ground. The vehicle may drive through the rear wheel remaining on the ground and cause you to lose control of your vehicle.

#### AXLE LOCK (TRU-LOK) FRONT AND REAR — IF EQUIPPED

The AXLE LOCK switch is located on the instrument panel (to the right of the steering column).

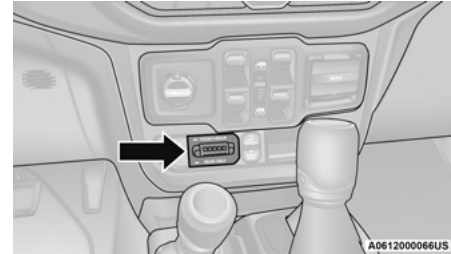

**Axle Lock Switch Panel**

This feature will only activate when the following conditions are met:

- Ignition in RUN position, vehicle in 4L.
- Vehicle speed should be 10 mph (16 km/h) or less.
- Both right and left wheels on axle are at the same speed.

To activate the system, push the AXLE LOCK switch down to lock the rear axle only (the “REAR ONLY” will illuminate), push the switch up to lock the front axle and rear axle (the “FRONT + REAR” will

illuminate). When the rear axle is locked, pushing the bottom of switch again will lock or unlock the front axle.

**NOTE:**

The indicator lights will flash until the axles are fully locked or unlocked.

To unlock the axles, push the AXLE LOCK OFF button.

Axle Lock will disengage if the vehicle is taken out of 4L, or the ignition switch is turned to the OFF position.

The Axle Lock disengages at speeds above 30 mph (48 km/h), and will automatically re-lock once vehicle speed is less than 10 mph (16 km/h).

## AXLE LOCK (TRU-LOK) REAR ONLY — IF EQUIPPED

The rear axle may be locked in 4H if the proper conditions are met.

**WARNING!**

This mode is intended for off-highway or off-road use only and should not be used on any public roadways.

The AXLE LOCK switch is located on the instrument panel (to the right of the steering column).

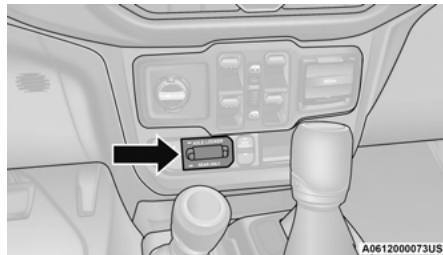

**Axle Lock Switch Panel**

This feature will only activate when the following conditions are met:

- Ignition in RUN position, vehicle in 4H.
- The vehicle must be in Off Road+ active  
↳ page 163.
- Vehicle must be in ESC “Full Off” mode  
↳ page 278.
- Vehicle must not be actively in a high wheel slip or tight cornering condition.

To activate the system, push the AXLE LOCK switch down to lock the rear axle only (“REAR ONLY” will illuminate).

To unlock the rear axle, push the AXLE LOCK OFF button.

Axle Lock will disengage if the vehicle is taken out of 4H, Off Road+ is turned off by the driver, ESC “Full Off” is exited, or the ignition switch is turned to the OFF position.

**NOTE:**

The indicator lights will flash until the rear axle is fully locked or unlocked.

The rear Axle Lock system may temporarily disengage the rear locker under some conditions.

If this occurs, the rear axle will automatically re-lock as soon as the system allows.

## ELECTRONIC SWAY BAR DISCONNECT — IF EQUIPPED

Your vehicle may be equipped with an electronic disconnecting stabilizer/sway bar. This system allows greater front suspension travel in off-road situations.

This system is controlled by the SWAY BAR switch located on the instrument panel (to the right of the steering column).

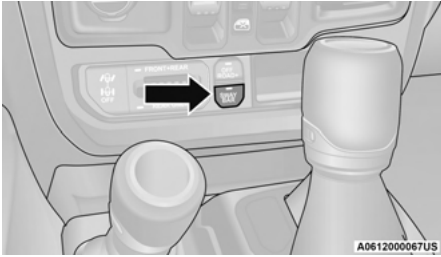
**SWAY BAR Switch**

Push the SWAY BAR switch to activate the system. Push the switch again to deactivate the system. The Sway Bar Indicator Light (located in the instrument cluster) will illuminate when the bar is disconnected. The Sway Bar Indicator Light will flash during activation transition, or when activation conditions are not met. The stabilizer/sway bar should remain in on-road mode during normal driving conditions.

**WARNING!**

Ensure the stabilizer/sway bar is reconnected before driving on hard surfaced roads or at speeds above 18 mph (29 km/h); a disconnected stabilizer/sway bar may contribute to the loss of vehicle control, which could result in serious injury. Under certain circumstances, the front stabilizer/sway bar enhances vehicle stability and assists with vehicle control. The system monitors vehicle speed and will attempt to reconnect the stabilizer/sway bar at speeds over 18 mph (29 km/h). This is indicated by a flashing or solid Sway Bar Indicator Light. Once vehicle speed is reduced below 14 mph (22 km/h), the system will once again attempt to return to off-road mode.

To disconnect the stabilizer/sway bar, shift to either 4H or 4L and push the SWAY BAR switch to obtain the off-road position ↗ page 157. The Sway Bar Indicator Light will flash until the stabilizer/sway bar has been fully disconnected.

**NOTE:**

The stabilizer/sway bar may be torque locked due to left and right suspension height differences. This condition is due to driving surface differences or vehicle loading. In order for the stabilizer/sway bar to disconnect/reconnect, the right and left halves of the bar must be aligned. This alignment

may require that the vehicle be driven onto level ground or rocked from side to side.

To return to on-road mode, push the SWAY BAR switch again.

**WARNING!**

If the stabilizer/sway bar will not return to on-road mode, the Sway Bar Indicator Light will flash in the instrument cluster and vehicle stability may be reduced. Do not attempt to drive the vehicle over 18 mph (29 km/h). Driving faster than 18 mph (29 km/h) with a disconnected stabilizer/sway bar may contribute to the loss of vehicle control, which could result in serious injury.

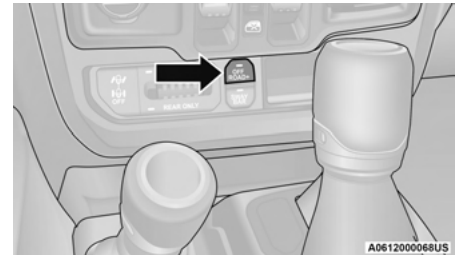
**4****OFF ROAD+ — IF EQUIPPED****OFF ROAD+ Switch**

When activated, Off Road+ is designed to improve the user experience when using specific Off Road driving modes. To activate Off Road+, push the OFF ROAD+ switch in the switch bank. The vehicle's performance will improve depending on which Four-Wheel Drive (4WD) mode is activated.

#### NOTE:

Off Road+ will not function in 2H mode. If the button is pushed while in 2H mode, the cluster display will show the message "Off Road+ Unavailable Shift to 4WD".

When Off Road+ is active, the following features will activate:

- The Off Road+ telltale will illuminate in the instrument cluster display
- A mode-specific message will display in the instrument cluster display
- Off-Road Pages will launch on the radio head-unit if selected in radio settings
- The Off-Road Camera will launch if selected in radio settings

Once in Off Road+, the vehicle will begin to behave in different ways depending on the 4WD mode in use. The following enhancements will occur when using Off Road+.

#### 4L

- Engine/Transmission Calibration: Rock Crawl and controllability focus, change in shifting schedule when rock crawling, pedal calibration shifted to de-gain and low range, operates at lower vehicle speeds
- Traction Control: Aggressive brake lock differential tuning at slower speed or FIRST gear
- Off Road+: Recall the last status between ignition cycles

#### 4H

- Engine/Transmission Calibration: Improved sand performance/wheel slip focus, change in shift schedule for sport mode, pedal calibration set to aggressive, operates at elevated vehicle speeds
- Traction Control: High wheel speed, slip tuning brake lock differential with no engine management
- Electronic Stability Control: ESC Off with unlimited speed
- Off Road+: Will default to OFF between ignition cycles

Cruise Control and Adaptive Cruise Control (ACC) will not function while using Off Road+. A dedicated cluster message will display indicating this if either feature is activated while in Off Road+.

If the ESC OFF button is pushed while in Off Road+, the following will occur on the vehicle:

- Push of the ESC OFF Button: Traction Control will turn off, but Stability Control will remain active.
- Hold the ESC OFF Button for five seconds: Traction Control and Stability Control will turn off.

## ELECTRO-HYDRAULIC POWER STEERING

Your vehicle is equipped with an Electro-Hydraulic Power Steering system that provides increased vehicle response and ease of maneuverability. The system adapts to different driving conditions. If the Electro-Hydraulic Power Steering system experiences a fault that prevents it from providing power steering assist, then the system will provide mechanical steering capability.

### CAUTION!

Extreme steering maneuvers may cause the electrically driven pump to reduce or stop power steering assistance in order to prevent damage to the system. Normal operation will resume once the system is allowed to cool.

If the “SERVICE POWER STEERING” message and a flashing icon are displayed on the instrument cluster screen, it indicates that the vehicle needs to be taken to an authorized dealer for service. It is likely the vehicle has lost power steering assistance → page 120.

If the “POWER STEERING HOT” message and an icon are displayed on the instrument cluster screen, it indicates that extreme steering maneuvers may have occurred, which caused an over temperature condition in the power steering system. You will lose power steering assistance momentarily until the over temperature condition no longer exists. Once driving conditions are safe, pull over and let vehicle idle for a few moments until the light turns off → page 120.

#### NOTE:

- Even if power steering assistance is no longer operational, it is still possible to steer the vehicle. Under these conditions there will be a substantial increase in steering effort, especially at very low vehicle speeds and during parking maneuvers.
- If the condition persists, see an authorized dealer for service.

## STOP/START SYSTEM — AUTOMATIC TRANSMISSION (IF EQUIPPED)

The Engine Stop/Start (ESS) function is developed to reduce fuel consumption. The system will stop the engine automatically during a vehicle stop if the required conditions are met. Releasing the brake pedal or pressing the accelerator pedal will automatically restart the engine.

ESS vehicles have been upgraded with a heavy-duty starter, enhanced battery, and other upgraded engine parts, to handle the additional engine starts. Vehicles equipped with eTorque contain a heavy-duty motor generator and an additional hybrid electric battery to store energy from vehicle deceleration for use on engine startup after a stop as well as providing launch torque assist.

#### NOTE:

It is recommended that Stop/Start system be disabled during off-road use.

#### Secondary Battery

Your vehicle may be equipped with a secondary battery used to power the Stop/Start system and the 12 Volt vehicle electrical system. The secondary battery is located behind the wheel well for the front passenger wheel.

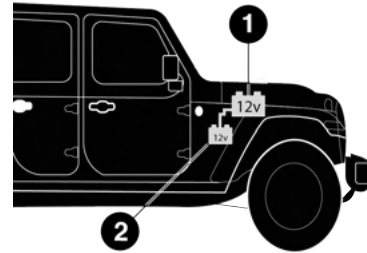

M0624000005US

**Battery Locations**

- 1 — Primary Battery  
2 — Secondary Battery

4

## AUTOSTOP MODE

#### WARNING!

- Vehicles with the Stop/Start system will be equipped with two batteries. Both the main and the supplemental batteries must be disconnected to completely de-energize the 12 Volt electrical system.
- Serious injury or death could result if you do not disconnect both batteries. To learn how to properly disconnect, see an authorized dealer.

The Stop/Start feature is enabled after every driver ignition start. At that time, the system will go into STOP/START READY and if all other conditions are met, can go into a STOP/START AUTOSTOP ACTIVE Autostop mode.

#### To Activate The Autostop Mode, The Following Must Occur:

- The system must be in STOP/START READY state. A STOP/START READY message will be displayed in the instrument cluster display within the Stop/Start section ↗ page 120.
- The vehicle must be completely stopped.
- The shifter must be in a forward gear and the brake pedal pressed.

#### POSSIBLE REASONS THE ENGINE DOES NOT AUTOSTOP

Prior to engine shut down, the system will check many safety and comfort conditions to see if they are fulfilled. Detailed information about the operation of the Stop/Start system may be viewed in the instrument cluster display Stop/Start Screen. Situations when the engine will not stop include (but not limited to):

- Driver's seat belt is not buckled.
- Driver's door is not closed.
- Battery temperature is too warm or cold.
- Battery charge is low.

- The vehicle is on a steep grade.
- Cabin heating or cooling is in process and an acceptable cabin temperature has not been achieved.
- Gear selector is in MANUAL (M) mode.
- HVAC is set to full defrost mode at a high blower speed.
- HVAC is set to MAX A/C.
- Engine has not reached normal operating temperature.
- Engine or exhaust temperature is too high.
- The transmission is not in a forward gear.
- Hood is open.
- Transfer case is in 4L or N (Neutral).
- Brake pedal is not pressed with sufficient pressure.
- Accelerator pedal input.
- Vehicle speed threshold has not been achieved from previous Autostop.
- Steering angle is beyond threshold (ESS Models Only).
- ACC is on and speed is set.
- Vehicle is at high altitude.
- System fault is present.

It may be possible for the vehicle to be driven several times without the Stop/Start system going

into a STOP/START READY state under more extreme conditions of the items listed above.

#### TO START THE ENGINE WHILE IN AUTOSTOP MODE

While in a forward gear, the engine will start when the brake pedal is released or the throttle pedal is pressed. The transmission will automatically re-engage upon engine restart.

#### Conditions That Will Cause The Engine To Start Automatically While In Autostop Mode:

- The transmission selector is moved out of DRIVE.
- To maintain cabin temperature comfort.
- Actual cabin temperature is significantly different than temperature set on Auto HVAC.
- HVAC is set to full defrost mode.
- HVAC system temperature or fan speed is manually adjusted higher.
- Battery voltage drops too low.
- Stop/Start OFF switch is pushed.
- A Stop/Start system error occurs.
- Stop/Start Autostop Active time exceeds five minutes.
- Transfer case is in 4L or N (Neutral).
- Steering wheel is turned beyond threshold (ESS Models Only).



## To MANUALLY TURN OFF THE STOP/ START SYSTEM

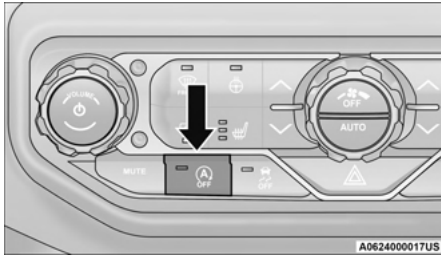

Stop/Start OFF Switch

Push the Stop/Start OFF switch (located on the switch bank). The light on the switch will illuminate. The “Stop/Start OFF” message will appear in instrument cluster display within the Stop/Start section, and the autostop function will be disabled ↷ page 120.

### NOTE:

The Stop/Start system will reset itself back to an ON condition every time the ignition is turned off and back on.

## To MANUALLY TURN ON THE STOP/ START SYSTEM

Push the Stop/Start OFF switch (located on the switch bank). The light on the switch will turn off.

## SYSTEM MALFUNCTION

If there is a malfunction in the Stop/Start system, the system will not shut down the engine. A “SERVICE STOP/START SYSTEM” message and a yellow Stop/Start telltale will appear in the Instrument Cluster Display ↷ page 120.

If the “SERVICE STOP/START SYSTEM” message appears in the instrument cluster display, have the system checked by an authorized dealer.

If a malfunction occurs during an autostop, the vehicle may not auto start and will need a key start.

## STOP/START SYSTEM — MANUAL TRANSMISSION (IF EQUIPPED)

The Engine Stop/Start (ESS) function is developed to reduce fuel consumption. The system will stop the engine automatically during a vehicle stop if the required conditions are met. Pressing the clutch pedal will automatically restart the vehicle.

ESS vehicles have been upgraded with a heavy-duty starter, enhanced battery, and other upgraded engine parts, to handle the additional engine starts. Vehicles equipped with eTorque contain a heavy duty motor generator and an additional hybrid electric battery to store energy from vehicle deceleration for use on engine startup after a stop as well as providing launch torque assist.

### NOTE:

It is recommended that Stop/Start be disabled during off-road use.

### Secondary Battery

Your vehicle may be equipped with a secondary battery used to power the Stop/Start system and the 12 Volt vehicle electrical system. The secondary battery is located behind the wheel well for the front passenger wheel.

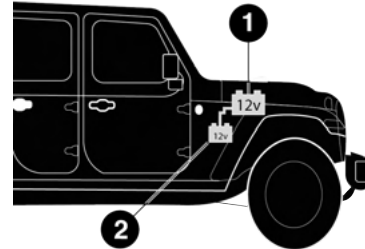

Battery Locations

1 — Primary Battery

2 — Secondary Battery

## AUTOSTOP MODE

### WARNING!

- Vehicles with the Stop/Start system will be equipped with two batteries. Both the main and the supplemental batteries must be disconnected to completely de-energize the 12 Volt electrical system.
- Serious injury or death could result if you do not disconnect both batteries. To learn how to properly disconnect, see an authorized dealer.

The Stop/Start feature is enabled after every driver ignition start. It will remain in STOP/START NOT READY until you drive forward with a vehicle speed greater than 5 mph (8 km/h). At that time, the system will go into STOP/START READY and if all other conditions are met, can go into an STOP/START AUTO STOP ACTIVE mode.

### To Activate The STOP/START AUTOSTOP ACTIVE Mode, The Following Must Occur:

- The system must be in STOP/START READY state. A STOP/START READY message will be displayed in the instrument cluster → page 120.
- Vehicle speed must be less than 2 mph (3 km/h).
- The gear selector must be in the NEUTRAL position and the clutch pedal must be fully released.

## POSSIBLE REASONS THE ENGINE DOES NOT AUTOSTOP

Prior to engine shut down, the system will check many safety and comfort conditions to see if they are fulfilled. Situations when the engine will not stop include (but not limited to):

- Driver's seat belt is not buckled.
- Outside temperature is less than 10° F (-12° C) or greater than 109° F (43° C).
- Actual cabin temperature is significantly different than temperature set on Auto HVAC.
- HVAC is set to full defrost mode.
- Engine has not reached normal operating temperature.
- Battery is discharged.
- When driving in REVERSE.
- Hood is open.
- Transfer case is in 4L or N (Neutral).
- Driver's seat is not occupied or driver's door is open.
- Vehicle is at high altitude.
- The vehicle is on a steep grade.
- Forward Gear is engaged.
- Steering angle is beyond threshold (ESS Models Only).

- System fault is present.
- HVAC is set to MAX A/C.

It may be possible for the vehicle to be driven several times without the Stop/Start system going into a STOP/START READY state under more extreme conditions of the items listed above.

## TO START THE ENGINE WHILE IN AUTOSTOP MODE

When the gear selector is in NEUTRAL, the engine will start when the clutch pedal is pressed (does not require complete/full pedal press). The vehicle will go into STOP/START SYSTEM NOT READY mode until the vehicle speed is greater than 5 mph (8 km/h).

### Conditions that will cause the engine to start automatically while in STOP/START AUTOSTOP ACTIVE mode

#### The Engine Will Start Automatically When:

- Actual cabin temperature is significantly different than temperature set on Auto HVAC.
- HVAC is set to full defrost mode.
- HVAC system temperature or fan speed is manually adjusted higher.
- Stop/Start Autostop Active time exceeds five minutes.
- Battery voltage drops too low.

- Vehicle is moving faster than 5 mph (8 km/h).
- STOP/START OFF switch is pressed.
- Transfer case is in 4L or N (Neutral).
- Steering wheel is turned beyond threshold (ESS Models Only).

## TO MANUALLY TURN OFF THE STOP/START SYSTEM

1. Push the Stop/Start OFF switch (located on the switch bank). The light on the switch will illuminate.

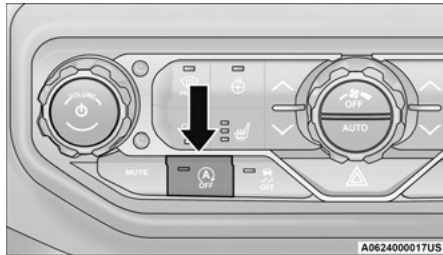

Stop/Start OFF Switch

2. The STOP/START OFF message will appear in the instrument cluster → page 120.

3. At the next vehicle stop (after turning off the Stop/Start system), the engine will not be stopped.
4. If the Stop/Start system is manually turned off, the engine can only be started and stopped by cycling the ignition switch.
5. The Stop/Start system will reset itself back to an ON condition every time the ignition is turned off and back on.

## TO MANUALLY TURN ON THE STOP/START SYSTEM

Push the Stop/Start OFF switch (located on the switch bank). The light on the switch will turn off.

## SYSTEM MALFUNCTION

If there is a malfunction in the Stop/Start system, the system will not shut down the engine. A “SERVICE STOP/START SYSTEM” message and a yellow Stop/Start telltale will appear in the Instrument Cluster Display → page 120.

If the “SERVICE STOP/START SYSTEM” message appears in the instrument cluster display, have the system checked by an authorized dealer.

If a malfunction occurs during an autostop, the vehicle may not auto start and will need a key start.

## CRUISE CONTROL SYSTEMS — IF EQUIPPED

Your vehicle may be equipped with the Cruise Control system, or the Adaptive Cruise Control (ACC) system:

- Cruise Control will keep your vehicle at a constant preset speed.
- Adaptive Cruise Control (ACC) will adjust the vehicle speed up to the preset speed to maintain a distance with the vehicle ahead.

### NOTE:

- In vehicles equipped with ACC, if ACC is not enabled, Fixed Speed Cruise Control will not detect vehicles directly ahead of you. Always be aware of the feature selected.
- Only one Cruise Control feature can operate at a time. For example, if Fixed Speed Cruise Control is enabled, Adaptive Cruise Control will be unavailable, and vice versa.

## CRUISE CONTROL

When engaged, the Cruise Control takes over accelerator operations at speeds greater than 20 mph (32 km/h).

The Cruise Control buttons are located on the right side of the steering wheel.

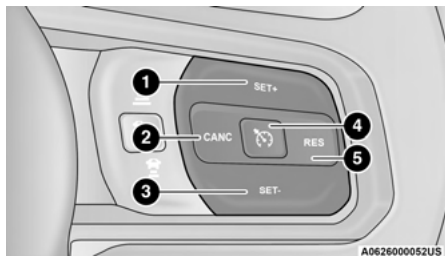

**Cruise Control Buttons**

- 1 – SET (+)/Accel
- 2 – CANCEL/Cancel
- 3 – SET (-)/Decel
- 4 – On/Off
- 5 – RES/Resume

**WARNING!**

Cruise Control can be dangerous where the system cannot maintain a constant speed. Your vehicle could go too fast for the conditions, and you could lose control and have an accident. Do not use Cruise Control in heavy traffic or on roads that are winding, icy, snow-covered or slippery.

### To Activate

Push the on/off button to activate the Cruise Control. The cruise indicator light in the instrument cluster display will illuminate. To turn the system off, push the on/off button a second time. The cruise indicator light will turn off. The system should be turned off when not in use.

**WARNING!**

Leaving the Cruise Control system on when not in use is dangerous. You could accidentally set the system or cause it to go faster than you want. You could lose control and have an accident. Always leave the system off when you are not using it.

### To Set A Desired Speed

Turn the Cruise Control on.

**NOTE:**

The vehicle should be traveling at a steady speed and on level ground before pushing the SET (+) or SET (-) button.

When the vehicle has reached the desired speed, push the SET (+) or SET (-) button and release. Release the accelerator and the vehicle will operate at the selected speed.

### To Vary The Speed Setting

#### To Increase Or Decrease The Set Speed

When the Cruise Control is set, you can increase speed by pushing the SET (+) button, or decrease speed by pushing the SET (-) button.

#### U.S. Speed (mph)

- Pushing the SET (+), or SET (-) button once will result in a 1 mph speed adjustment. Each subsequent tap of the button results in an adjustment of 1 mph.
- If the button is continually pushed, the set speed will continue to adjust in 5 mph increments until the button is released, then the new set speed will be established.

#### Metric Speed (km/h)

- Pushing the SET (+), or SET (-) button once will result in a 1 km/h speed adjustment. Each subsequent tap of the button results in an adjustment of 1 km/h.
- If the button is continually pushed, the set speed will continue to adjust in 10 km/h increments until the button is released, then the new set speed will be established.

## To Accelerate For Passing

While the Cruise Control is set, press the accelerator to pass as you would normally. When the pedal is released, the vehicle will return to the set speed.

## USING CRUISE CONTROL ON HILLS

The transmission may downshift on hills to maintain the vehicle set speed.

The Cruise Control system maintains speed up and down hills. A slight speed change on moderate hills is normal. On steep hills, a greater speed loss or gain may occur so it may be preferable to drive without Cruise Control.

### WARNING!

Cruise Control can be dangerous where the system cannot maintain a constant speed. Your vehicle could go too fast for the conditions, and you could lose control and have an accident. Do not use Cruise Control in heavy traffic or on roads that are winding, icy, snow-covered or slippery.

## To Resume Speed

To resume a previously set speed, push the RES button and release. Resume can be used at any speed above 20 mph (32 km/h).

## To Deactivate

A tap on the brake pedal, pushing the CANC (cancel) button, or normal brake pressure while slowing the vehicle will deactivate the Cruise Control without erasing the set speed from memory.

The following conditions will also deactivate the Cruise Control without erasing the set speed from memory:

- Vehicle parking brake is applied
- Stability event occurs
- Gear selector is moved out of DRIVE
- Engine overspeed occurs
- Clutch pedal is pressed (manual transmission only)
- Vehicle is operating at a low RPM (manual transmission only)

Pushing the on/off button or placing the ignition in the OFF position erases the set speed from memory.

## ADAPTIVE CRUISE CONTROL (ACC)

Adaptive Cruise Control (ACC) increases the driving convenience provided by Cruise Control while traveling on highways and major roadways. However, it is not a safety system and not designed to prevent collisions. The Cruise Control function performs differently if your vehicle is not equipped with ACC → page 169.

### NOTE:

- If the ACC sensor detects a vehicle ahead, ACC will apply limited braking or accelerate (not to exceed the original set speed) automatically to maintain a preset following distance, while matching the speed of the vehicle ahead.
- Any chassis/suspension or tire size modifications to the vehicle will affect the performance of the Adaptive Cruise Control and Forward Collision Warning system.
- Fixed Speed Cruise Control (ACC not enabled) will not detect vehicles directly ahead of you. Always be aware of the feature selected → page 431.

**WARNING!**

- Adaptive Cruise Control (ACC) is a convenience system. It is not a substitute for active driver involvement. It is always the driver's responsibility to be attentive of road, traffic, and weather conditions, vehicle speed, distance to the vehicle ahead and, most importantly, brake operation to ensure safe operation of the vehicle under all road conditions. Your complete attention is always required while driving to maintain safe control of your vehicle. Failure to follow these warnings can result in a collision and death or serious personal injury.
- The ACC system:
  - Does not react to pedestrians, oncoming vehicles, and stationary objects (e.g., a stopped vehicle in a traffic jam or a disabled vehicle).
  - Cannot take street, traffic, and weather conditions into account, and may be limited upon adverse sight distance conditions.
  - Does not always fully recognize complex driving conditions, which can result in wrong or missing distance warnings.

*(Continued)***WARNING!**

- On vehicles with an automatic transmission, will bring the vehicle to a complete stop while following a vehicle ahead and hold the vehicle for two seconds in the stop position. If the vehicle ahead does not start moving within two seconds, the ACC system will display a message that the system will release the brakes and that the brakes must be applied manually. An audible chime will sound when the brakes are released.
- You should switch off the ACC system:
  - When driving in fog, heavy rain, heavy snow, sleet, heavy traffic, and complex driving situations (i.e., in highway construction zones).
  - When entering a turn lane or highway off-ramp; when driving on roads that are winding, icy, snow-covered, slippery, or have steep uphill or downhill slopes.
  - When towing a trailer up or down steep slopes.
  - When circumstances do not allow safe driving at a constant speed.

**Adaptive Cruise Control (ACC) Operation**

The buttons on the right side of the steering wheel operate the ACC system.

**Adaptive Cruise Control Buttons**

- 1 — Distance Setting Increase
- 2 — Adaptive Cruise Control (ACC) On/Off
- 3 — Distance Setting Decrease

**Adaptive Cruise Control (ACC) Menu**

The instrument cluster display will show the current ACC system settings. The information it displays depends on ACC system status.

Push the Adaptive Cruise Control (ACC) on/off button until one of the following appears in the instrument cluster display:

### Adaptive Cruise Control Off

When ACC is deactivated, the display will read “Adaptive Cruise Control Off.”

### Adaptive Cruise Control Ready

When ACC is activated, but the vehicle speed setting has not been selected, the display will read “Adaptive Cruise Control Ready.”

### Adaptive Cruise Control Set

When the SET (+) or the SET (-) button is pushed, the display will read “ACC SET.”

When ACC is set, the set speed will show in the instrument cluster display.

The ACC screen may display once again if any of the following ACC activity occurs:

- System Cancel
- Driver Override
- System Off
- ACC Proximity Warning
- ACC Unavailable Warning

The instrument cluster display will return to the last display selected after five seconds of no ACC display activity.

### Activating Adaptive Cruise Control (ACC)

The minimum set speed for the ACC system is 20 mph (32 km/h).

When the system is turned on and in the ready state, the instrument cluster displays “ACC Ready.”

When the system is off, the instrument cluster displays “Adaptive Cruise Control (ACC) Off.”

#### NOTE:

You cannot engage ACC under the following conditions:

- When in 4WD Low
- When the brakes are applied
- When the parking brake is applied
- When the automatic transmission is in PARK, REVERSE or NEUTRAL
- When the manual transmission is in FIRST gear
- When the vehicle speed is below 20 mph (32 km/h) (manual transmission)
- When the vehicle speed is below the minimum speed range
- When the brakes are overheated
- When the driver’s door is open at low speeds
- When the driver’s seat belt is unbuckled at low speeds
- When ESC Full Off mode is active
- When Off Road+ (if equipped) is active

### To Activate/Deactivate

Push and release the Adaptive Cruise Control (ACC) on/off button. The ACC menu in the instrument cluster display will read “ACC Ready.”

To turn the system off, push and release the Adaptive Cruise Control (ACC) on/off button again. At this time, the system will turn off and the instrument cluster display will read “Adaptive Cruise Control (ACC) Off.”

#### WARNING!

Leaving the Adaptive Cruise Control (ACC) system on when not in use is dangerous. You could accidentally set the system or cause it to go faster than you want. You could lose control and have a collision. Always leave the system off when you are not using it.

4

### To Set A Desired Speed

When the vehicle reaches the speed desired, push the SET (+) button or the SET (-) button and release. The instrument cluster display will show the set speed.

#### NOTE:

Fixed Speed Cruise Control can be used without ACC enabled. To change between the different modes, push the **ACC on/off button** which turns the ACC and the Fixed Speed Cruise Control off.

Pushing the **Fixed Speed Cruise Control on/off button** will result in turning on (changing to) Fixed Speed Cruise Control mode.

#### WARNING!

In Fixed Speed Cruise Control mode, the system will not react to vehicles ahead. In addition, the proximity warning does not activate and no alarm will sound even if you are too close to the vehicle ahead since neither the presence of the vehicle ahead nor the vehicle-to-vehicle distance is detected. Be sure to maintain a safe distance between your vehicle and the vehicle ahead. Always be aware which mode is selected.

If ACC is set when the vehicle speed is **below** 20 mph (32 km/h), the set speed will default to 20 mph (32 km/h).

#### NOTE:

Fixed Speed Cruise Control cannot be set below 20 mph (32 km/h).

If either system is set when the vehicle speed is **above** 20 mph (32 km/h), the set speed shall be the current speed of the vehicle.

On vehicles equipped with a manual transmission, the ACC system cannot be set when the vehicle speed is below 20 mph (32 km/h) or when the vehicle is in **FIRST** gear.

#### NOTE:

- Keeping your foot on the accelerator pedal can cause the vehicle to continue to accelerate beyond the set speed. If this occurs, the message "DRIVER OVERRIDE" will display in the instrument cluster display.
- If you continue to accelerate beyond the set speed while ACC is enabled, the system will not be controlling the distance between your vehicle and the vehicle ahead. The vehicle speed will only be determined by the position of the accelerator pedal.

#### To Cancel

The following conditions cancel the ACC or Fixed Speed Cruise Control systems:

- The brake pedal is applied
- The CANC button is pushed
- The Anti-Lock Brake System (ABS) activates
- The gear selector is removed from the DRIVE position
- The Electronic Stability Control/Traction Control System (ESC/TCS) activates
- The vehicle parking brake is applied
- The braking temperature exceeds normal range (overheated)
- The Trailer Sway Control (TSC) activates

- The vehicle speed is less than 15 mph (24 km/h) (manual transmission only)
- The clutch is pressed for more than 10 seconds (manual transmission only)
- The vehicle is placed in **NEUTRAL** for more than 10 seconds (manual transmission only)
- The driver shifts to **FIRST** gear (manual transmission only)

The following conditions will only cancel the ACC system:

- Driver seat belt is unbuckled at low speeds
- Driver door is opened at low speeds

#### To Turn Off

The system will turn off and erase the set speed in memory if:

- The Adaptive Cruise Control (ACC) on/off button is pushed
- The Fixed Speed Cruise Control on/off button is pushed
- The ignition is placed in the **OFF** position
- 4WD Low is engaged

#### To Resume

If there is a set speed in the memory, push the **RES** button and then remove your foot from the accelerator pedal. The instrument cluster display will show the last set speed.



Resume can be used at any speed above 20 mph (32 km/h) when only Fixed Speed Cruise Control is being used.

Resume can be used at any speed above 0 mph (0 km/h) when ACC is active.

#### NOTE:

- While in ACC mode, when the vehicle comes to a complete stop longer than two seconds, the system will cancel. The driver will have to apply the brakes to keep the vehicle at a standstill.
- ACC cannot be resumed if there is a stationary vehicle in front of your vehicle in close proximity.

#### WARNING!

The Resume function should only be used if traffic and road conditions permit. Resuming a set speed that is too high or too low for prevailing traffic and road conditions could cause the vehicle to accelerate or decelerate too sharply for safe operation. Failure to follow these warnings can result in a collision and death or serious personal injury.

## To Vary The Speed Setting

### To Increase Or Decrease The Set Speed

After setting a speed, you can increase the set speed by pushing the SET (+) button, or decrease speed by pushing the SET (-) button.

### U.S. Speed (mph)

- Pushing the SET (+), or SET (-) button once will result in a 1 mph speed adjustment. Each subsequent tap of the button results in an adjustment of 1 mph.
- If the button is continually pushed, the set speed will continue to adjust in 5 mph increments until the button is released. The new set speed is reflected in the instrument cluster display.

### Metric Speed (km/h)

- Pushing the SET (+), or SET (-) button once will result in a 1 km/h speed adjustment. Each subsequent tap of the button results in an adjustment of 1 km/h.
- If the button is continually pushed, the set speed will continue to adjust in 10 km/h increments until the button is released. The new set speed is reflected in the instrument cluster display.

#### NOTE:

When you override and push the SET (+) button or SET (-) buttons, the new set speed will be the current speed of the vehicle.

### When ACC Is Active

- When you use the SET (-) button to decelerate, if the engine's braking power does not slow the vehicle sufficiently to reach the set speed, the brake system will automatically slow the vehicle.
- The ACC system applies the brake down to a full stop when following the vehicle in front. If your vehicle follows the vehicle in front to a standstill, your vehicle will release the brakes two seconds after coming to a full stop.
- The ACC system maintains set speed when driving uphill and downhill. However, a slight speed change on moderate hills is normal. In addition, downshifting may occur while climbing uphill or descending downhill. This is normal operation and necessary to maintain set speed. When driving uphill and downhill, the ACC system will cancel if the braking temperature exceeds normal range (overheated).

## Setting The Following Distance In ACC

The specified following distance for ACC can be set by varying the distance setting between four bars (longest), three bars (long), two bars (medium) and one bar (short). Using this distance setting and the vehicle speed, ACC calculates and sets the distance to the vehicle ahead. This distance setting displays in the instrument cluster display.

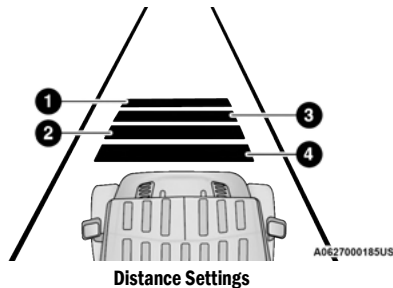

- 1 – Longest Distance Setting (Four Bars)  
 2 – Medium Distance Setting (Two Bars)  
 3 – Long Distance Setting (Three Bars)  
 4 – Short Distance Setting (One Bar)

To increase the distance setting, push the Distance Setting Increase button and release. Each time the button is pushed, the distance setting increases by one bar (longer).

To decrease the distance setting, push the Distance Setting Decrease button and release. Each time the button is pushed, the distance setting decreases by one bar (shorter).

If there is no vehicle ahead, the vehicle will maintain the set speed. If a slower moving vehicle is detected in the same lane, the instrument cluster displays the ACC Set With Target Light. The system will then adjust vehicle speed

automatically to maintain the distance setting, regardless of the set speed.

The vehicle will then maintain the set distance until:

- The vehicle ahead accelerates to a speed above the set speed
- The vehicle ahead moves out of your lane or view of the sensor
- The distance setting is changed
- The system disengages → page 173

The maximum braking applied by ACC is limited; however, the driver can always apply the brakes manually, if necessary.

#### NOTE:

The brake lights will illuminate whenever the ACC system applies the brakes.

A Proximity Warning will alert the driver if ACC predicts that its maximum braking level is not sufficient to maintain the set distance. If this occurs, a visual alert “BRAKE!” will flash in the instrument cluster display and a chime will sound while ACC continues to apply its maximum braking capacity.

#### NOTE:

The “BRAKE!” screen in the instrument cluster display is a warning for the driver to take action and does not necessarily mean that the Forward

Collision Warning system is applying the brakes autonomously.

### Overtake Aid

When driving with ACC engaged and following a vehicle, the system will provide an additional acceleration up to the ACC set speed to assist in passing the vehicle. This additional acceleration is triggered when the driver utilizes the left turn signal and will only be active when passing on the left hand side.

### ACC Operation At A Stop (Automatic Transmission Only)

In the event that the ACC system brings your vehicle to a standstill while following a target vehicle, your vehicle will resume motion without the need for any driver action if the target vehicle starts moving within two seconds of your vehicle coming to a standstill.

If the target vehicle does not start moving within two seconds of your vehicle coming to a standstill, the ACC with Stop system will cancel and the brakes will release. A cancel message will display on the instrument cluster display and produce a warning chime. Driver intervention will be required at this moment.

While ACC with Stop is holding your vehicle at a standstill, if the driver seatbelt is unbuckled or the driver door is opened, the ACC with Stop system will cancel and the brakes will release. A cancel

message will display on the instrument cluster display and produce a warning chime. Driver intervention will be required at this moment.

### WARNING!

When the ACC system is resumed, the driver must ensure that there are no pedestrians, vehicles or objects in the path of the vehicle. Failure to follow these warnings can result in a collision and death or serious personal injury.

## Display Warnings And Maintenance

### “WIPE FRONT RADAR SENSOR IN FRONT OF VEHICLE” WARNING

The “ACC/FCW Unavailable Wipe Front Radar Sensor” warning will display and a chime will sound when conditions temporarily limit system performance.

This most often occurs at times of poor visibility, such as in snow or heavy rain. The ACC system may also become temporarily blinded due to obstructions, such as mud, dirt or ice. In these cases, the instrument cluster display will display “ACC/FCW Unavailable Wipe Front Radar Sensor” and the system will deactivate.

The “ACC/FCW Unavailable Wipe Front Radar Sensor” message can sometimes be displayed while driving in highly reflective areas (i.e. tunnels

with reflective tiles, or ice and snow). The ACC system will recover after the vehicle has left these areas. Under rare conditions, when the radar is not tracking any vehicles or objects in its path this warning may temporarily occur.

### NOTE:

If the “ACC/FCW Unavailable Wipe Front Radar Sensor” warning is active, Fixed Speed Cruise Control is still available.

If weather conditions are not a factor, the driver should examine the sensor. It may require cleaning or removal of an obstruction. The sensor is located in the center of the vehicle behind the lower grille.

To keep the ACC system operating properly, it is important to note the following maintenance items:

- Always keep the sensor clean. Carefully wipe the sensor lens with a soft cloth. Be cautious not to damage the sensor lens.
- Do not remove any screws from the sensor. Doing so could cause an ACC system malfunction or failure and require a sensor realignment.
- If the sensor or front end of the vehicle is damaged due to a collision, see an authorized dealer for service.
- Do not attach or install any accessories near the sensor, including transparent material or aftermarket grilles. Doing so could cause an ACC system failure or malfunction.

When the condition that deactivated the system is no longer present, the system will return to the “Adaptive Cruise Control Off” state and will resume function by simply reactivating it.

### NOTE:

If the “ACC/FCW Unavailable Wipe Front Radar Sensor” message occurs frequently (e.g. more than once on every trip) without any snow, rain, mud, or other obstruction, have the radar sensor realigned at an authorized dealer.

### “CLEAN FRONT WINDSHIELD” WARNING

The “ACC/FCW Limited Functionality Clean Front Windshield” warning will display and a chime will sound when conditions temporarily limit system performance. This most often occurs at times of poor visibility, such as in snow or heavy rain and fog. The ACC system may also become temporarily blinded due to obstructions, such as mud, dirt, or ice on windshield and fog on the inside of glass. In these cases, the instrument cluster display will display “ACC/FCW Limited Functionality Clean Front Windshield” and the system will have degraded performance.

The “ACC/FCW Limited Functionality Clean Front Windshield” message can sometimes be displayed while driving in adverse weather conditions. The ACC/FCW system will recover after the vehicle has left these areas. Under rare conditions, when the camera is not tracking any vehicles or objects in its path this warning may temporarily occur.

If weather conditions are not a factor, the driver should examine the windshield and the camera located on the back side of the inside rear view mirror. They may require cleaning or removal of an obstruction.

When the condition that created limited functionality is no longer present, the system will return to full functionality.

#### NOTE:

If the “ACC/FCW Limited Functionality Clean Front Windshield” message occurs frequently (e.g. more than once on every trip) without any snow, rain, mud, or other obstruction, have the windshield and forward facing camera inspected at an authorized dealer.

#### “SERVICE ACC/FCW” WARNING

If the system turns off, and the instrument cluster displays “ACC/FCW Unavailable Service Required” or “Cruise/FCW Unavailable Service Required”, there may be an internal system fault or a temporary malfunction that limits ACC functionality. Although the vehicle is still drivable under normal conditions, ACC will be temporarily unavailable. If this occurs, try activating ACC again later, following an ignition cycle. If the problem persists, see an authorized dealer.

#### Precautions While Driving With ACC

In certain driving situations, ACC may have detection issues. In these cases, ACC may brake

late or unexpectedly. The driver needs to stay alert and may need to intervene. The following are examples of these types of situations:

#### TOWING A TRAILER

Towing a trailer is not recommended when using ACC.

#### OFFSET DRIVING

ACC may not detect a vehicle in the same lane that is offset from your direct line of travel, or a vehicle merging in from a side lane. There may not be sufficient distance to the vehicle ahead. The offset vehicle may move in and out of the line of travel, which can cause your vehicle to brake or accelerate unexpectedly.

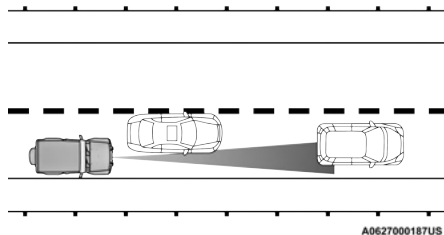

Offset Driving Condition Example

A0627000187US

#### TURNS AND BENDS

When driving on a curve with ACC engaged, the system may decrease the vehicle speed and acceleration for stability reasons, with no vehicle in front detected. Once the vehicle is out of the curve the system will resume your original set speed. This is a part of normal ACC system functionality.

#### NOTE:

On tight turns ACC performance may be limited.

#### USING ACC ON HILLS

ACC performance may be limited when driving on hills. ACC may not detect a vehicle in your lane depending on the speed, vehicle load, traffic conditions, and the steepness of the hill.

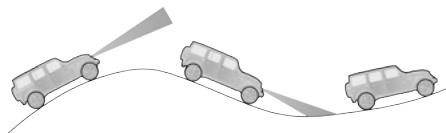

ACC Hill Example

A0627000186US

## LANE CHANGING

ACC may not detect a vehicle until it is completely in the lane in which you are traveling. In the following lane changing example, ACC has not yet detected the vehicle changing lanes and it may not detect the vehicle until it's too late for the ACC system to take action. ACC may not detect a vehicle until it is completely in the lane. There may not be sufficient distance to the lane-changing vehicle. Always be attentive and ready to apply the brakes if necessary.

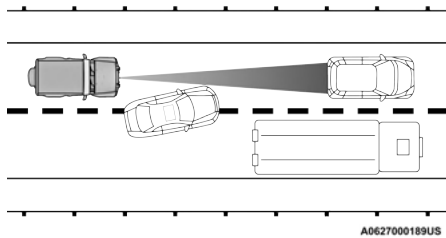

Lane Changing Example

A0627000189US

## NARROW VEHICLES

Some narrow vehicles traveling near the outer edges of the lane or edging into the lane are not detected until they have moved fully into the lane. There may not be sufficient distance to the vehicle ahead.

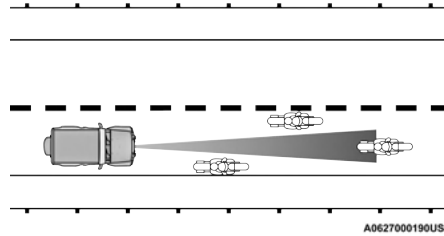

Narrow Vehicle Example

A0627000190US

## STATIONARY OBJECTS AND VEHICLES

ACC does not react to stationary objects or vehicles. For example, ACC will not react in situations where the vehicle you are following exits your lane and the vehicle ahead is stopped in your lane. It will consider this stopped vehicle a stationary object as it did not previously detect movement from it. Always be attentive and ready to apply the brakes if necessary.

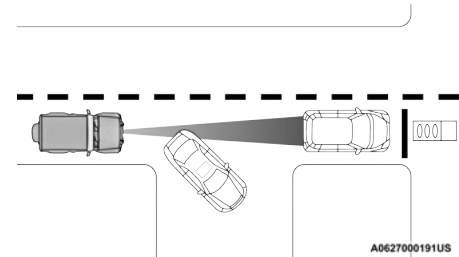

Stationary Object And Stationary Vehicle Example

A0627000191US

## **PARKSENSE REAR PARK ASSIST — IF EQUIPPED**

The ParkSense Rear Park Assist system provides visual and audible indications of the distance between the rear fascia/bumper and a detected obstacle when backing up (e.g. during a parking maneuver). For limitations of this system and recommendations, see ⇨ page 183.

ParkSense will retain the last system state (enabled or disabled) from the last ignition cycle when the ignition is placed in the ON/RUN position.

ParkSense can be active only when the gear selector is in REVERSE. If ParkSense is enabled at this gear selector position, the system will remain active until the vehicle speed is increased to approximately 7 mph (11 km/h) or above. When in REVERSE and above the system's operating speed, a warning will appear within the instrument cluster display indicating the vehicle speed is too fast. The system will become active again if the vehicle speed is decreased to speeds less than approximately 6 mph (9 km/h).

## **PARKSENSE SENSORS**

The four ParkSense sensors, located in the rear fascia/bumper, monitor the area behind the vehicle that is within the sensors' field of view. The sensors can detect obstacles from approximately 12 inches (30 cm) up to 79 inches (200 cm) from the rear fascia/bumper in the horizontal direction, depending on the location, type and orientation of the obstacle.

## **PARKSENSE WARNING DISPLAY**

The ParkSense Warning screen is located within the instrument cluster display ⇨ page 120. It provides visual warnings to indicate the distance between the rear fascia/bumper and the detected obstacle.

## **PARKSENSE DISPLAY**

When the vehicle is in REVERSE, the instrument cluster display will show the park assist ready system status.

The system will indicate a detected obstacle by showing a single arc in one or more regions based on the obstacle's distance and location relative to the vehicle.

If an obstacle is detected in the center rear region, the display will show a single solid arc in the center rear region and will produce a one-half second tone. As the vehicle moves closer to the obstacle, the display will show a single arc moving closer to the vehicle and emit a fast sound tone that will change from fast to continuous.

If an obstacle is detected in the left and/or right rear region, the display will show a single flashing arc in the left and/or right rear region and will produce a fast sound tone. As the vehicle moves closer to the obstacle, the display will show the single arc moving closer to the vehicle and the tone will change from fast to continuous.

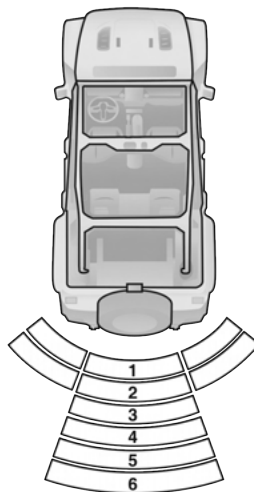

A0628000178US

**Rear ParkSense Arcs**

- 1 – Continuous Tone/Flashing Arc
- 2 – Fast Tone/Flashing Arc
- 3 – Fast Tone/Flashing Arc

- 4 – Slow Tone/Solid Arc
- 5 – Slow Tone/Solid Arc
- 6 – Single 1/2 Second Tone/Solid Arc

The vehicle is close to the obstacle when the warning display shows one flashing arc and sounds a continuous tone. The following chart shows the warning alert operation when the system is detecting an obstacle:

WARNING ALERTS							
Rear Distance (inches/cm)	Greater than 79 inches (200 cm)	79-59 inches (200-150 cm)	59-47 inches (150-120 cm)	47-39 inches (120-100 cm)	39-25 inches (100-65 cm)	25-12 inches (65-30 cm)	Less than 12 inches (30 cm)
Arcs — Left	None	None	None	None	None	2nd Flashing	1st Flashing
Arcs — Center	None	6th Solid	5th Solid	4th Solid	3rd Flashing	2nd Flashing	1st Flashing
Arcs — Right	None	None	None	None	None	2nd Flashing	1st Flashing
Audible Alert Chime	None	Single 1/2 Second Tone (for rear center only)	Slow (for rear center only)	Slow (for rear center only)	Fast (for rear center only)	Fast	Continuous
Radio Volume Reduced	No	Yes	Yes	Yes	Yes	Yes	Yes

**NOTE:**

ParkSense will reduce the volume of the radio, if on, when the system is sounding an audio tone.

**ENABLING AND DISABLING PARKSENSE**

ParkSense can be enabled and disabled with the ParkSense switch located below the Uconnect display.

When the ParkSense switch is pushed to disable the system, the instrument cluster display  page 120 will show the “PARKSENSE OFF” message for approximately five seconds. When the

gear selector is moved to REVERSE and the system is disabled, the instrument cluster display will show the “PARKSENSE OFF” message for as long as the vehicle is in REVERSE (Not in 4WD Low).

The ParkSense switch LED will be on when ParkSense is disabled or requires service. The ParkSense switch LED will be off when the system is enabled. If the ParkSense switch is pushed, and requires service, the ParkSense switch LED will blink momentarily, and then the LED will remain on.

**SERVICE THE PARKSENSE REAR PARK ASSIST SYSTEM**

During vehicle start up, when the ParkSense Rear Park Assist System has detected a faulted condition, the instrument cluster display will actuate a single chime, once per ignition cycle, and it will display the “PARKSENSE UNAVAILABLE WIPE REAR SENSORS” or the “PARKSENSE UNAVAILABLE SERVICE REQUIRED” message.



When the gear selector is moved to REVERSE and the system has detected a faulted condition, the instrument cluster display will show the "PARKSENSE UNAVAILABLE WIPE REAR SENSORS" or "PARKSENSE UNAVAILABLE SERVICE REQUIRED" message for as long as the vehicle is in REVERSE. Under this condition, ParkSense will not operate.

If "PARKSENSE UNAVAILABLE WIPE REAR SENSORS" appears in the instrument cluster display, make sure the outer surface and the underside of the rear fascia/bumper is clean and clear of snow, ice, mud, dirt or other obstruction and then cycle the ignition. If the message continues to appear, see an authorized dealer.

If "PARKSENSE UNAVAILABLE SERVICE REQUIRED" appears in the instrument cluster display, see an authorized dealer.

## CLEANING THE PARKSENSE SYSTEM

Clean the Rear Park Assist sensors with water, car wash soap and a soft cloth. Do not use rough or hard cloths. In washing stations, clean sensors quickly keeping the vapor jet/high pressure washing nozzles at least 4 inches (10 cm) from the sensors. Do not scratch or poke the sensors.

## PARKSENSE SYSTEM USAGE PRECAUTIONS

### NOTE:

- Ensure that the rear fascia/bumper is free of snow, ice, mud, dirt and debris to keep the ParkSense system operating properly.
- Jackhammers, large trucks, and other vibrations could affect the performance of ParkSense.
- When you turn ParkSense off, the instrument cluster display will read "PARKSENSE OFF." Furthermore, once you turn ParkSense off, it remains off until you turn it on again, even if you cycle the ignition.
- ParkSense, when on, will reduce the volume of the radio when it is sounding a tone.
- Clean the ParkSense sensors regularly, taking care not to scratch or damage them. The sensors must not be covered with ice, snow, slush, mud, dirt or debris. Failure to do so can result in the system not working properly. The ParkSense system might not detect an obstacle behind the fascia/bumper, or it could provide a false indication that an obstacle is behind the fascia/bumper.
- Use the ParkSense switch to turn the ParkSense system off if objects such as bicycle carriers, trailer hitches, etc. are placed within 12 inches

(30 cm) of the rear fascia/bumper. Failure to do so can result in the system misinterpreting a close object as a sensor problem, causing the "PARKSENSE UNAVAILABLE SERVICE REQUIRED" message to be displayed in the instrument cluster display.

### WARNING!

- Drivers must be careful when backing up even when using ParkSense. Always check carefully behind your vehicle, look behind you, and be sure to check for pedestrians, animals, other vehicles, obstructions, and blind spots before backing up. You are responsible for safety and must continue to pay attention to your surroundings. Failure to do so can result in serious injury or death.
- Before using ParkSense, it is strongly recommended that the ball mount and hitch ball assembly be disconnected from the vehicle when the vehicle is not used for towing. Failure to do so can result in injury or damage to vehicles or obstacles because the hitch ball will be much closer to the obstacle than the rear fascia when the vehicle sounds the continuous tone. Also, the sensors could detect the ball mount and hitch ball assembly, depending on its size and shape, giving a false indication that an obstacle is behind the vehicle.

**CAUTION!**

- ParkSense is only a parking aid and it is unable to recognize every obstacle, including small obstacles. Parking curbs might be temporarily detected or not detected at all. Obstacles located above or below the sensors will not be detected when they are in close proximity.
- The vehicle must be driven slowly when using ParkSense in order to be able to stop in time when an obstacle is detected. It is recommended that the driver looks over his/her shoulder when using ParkSense.

**PARKVIEW REAR BACK UP CAMERA**

The ParkView Rear Back Up Camera allows you to see an on-screen image of the rear surroundings of your vehicle whenever the gear selector is put into REVERSE. The image will be displayed in the touchscreen display along with a caution note to “Check Entire Surroundings” across the top of the screen. After five seconds this note will disappear. The ParkView camera is located on the rear of the vehicle in the center of the spare tire.

**Manual Activation Of The Rear View Camera**

1. Press the Controls button located on the bottom of the Uconnect display.
2. Press the Back Up Camera button to turn the Rear View Camera system on.

When the vehicle is shifted out of REVERSE with Camera delay turned off, the rear Camera mode is exited and the previous screen appears again.

When the vehicle is shifted out of REVERSE with Camera delay turned on, the rear Camera image will be displayed for up to 10 seconds unless the vehicle speed exceeds 8 mph (13 km/h), the transmission is shifted into PARK, the ignition is placed in the OFF position, or the touchscreen button X to disable display of the Rear View Camera image is pressed.

Whenever the Rear View Camera image is activated through the Back Up Camera button in the Controls menu, and the vehicle speed is greater than, or equal to, 8 mph (13 km/h), a display timer for the image is initiated. The image will continue to be displayed until the display timer exceeds 10 seconds.

**NOTE:**

- If the vehicle speed remains below 8 mph (13 km/h), the Rear View Camera image will be displayed continuously until deactivated via the

touchscreen button X, the transmission is shifted into PARK, or the ignition is placed in the OFF position.

- The touchscreen button X to disable display of the camera image is made available ONLY when the vehicle is not in REVERSE.

When enabled, active guidelines are overlaid on the image to illustrate the width of the vehicle and its projected backup path based on the steering wheel position. A dashed center line overlay indicates the center of the vehicle to assist with parking or aligning to a hitch/receiver.

When enabled, fixed guidelines are overlaid on the image to illustrate the width of the vehicle.

Different colored zones indicate the distance to the rear of the vehicle.

The following table shows the approximate distances for each zone:

Zone	Distance To The Rear Of The Vehicle
Red	0 - 1 ft (0 - 30 cm)
Yellow	1 ft - 6.5 ft (30 cm - 2 m)
Green	6.5 ft or greater (2 m or greater)

**WARNING!**

Drivers must be careful when backing up even when using the ParkView Rear Back Up Camera. Always check carefully behind your vehicle, and be sure to check for pedestrians, animals, other vehicles, obstructions, or blind spots before backing up. You are responsible for the safety of your surroundings and must continue to pay attention while backing up. Failure to do so can result in serious injury or death.

**CAUTION!**

- To avoid vehicle damage, ParkView should only be used as a parking aid. The ParkView camera is unable to view every obstacle or object in your drive path.
- To avoid vehicle damage, the vehicle must be driven slowly when using ParkView to be able to stop in time when an obstacle is seen. It is recommended that the driver look frequently over his/her shoulder when using ParkView.

**NOTE:**

If snow, ice, mud, or any foreign substance builds up on the camera lens, clean the lens, rinse with water, and dry with a soft cloth. Do not cover the lens.

**TRAILCAM SYSTEM — IF EQUIPPED**

Your vehicle may be equipped with a TrailCam that allows you to see an on-screen image of the front view of your vehicle. The image will be displayed on the touchscreen display along with a caution note “Check Entire Surroundings” across the top of the screen.

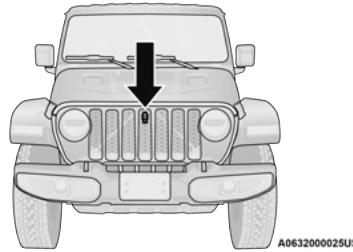

**Front View Camera**

**NOTE:**



The system will stay active while in 4WD Low.

The TrailCam system has programmable settings that may be selected through the Uconnect system  
 ☞ page 207.

**Manual Activation Of The TrailCam**

TrailCam view can be activated via the below methods:

- Press the FWD Camera button on the controls screen.
- Press the Forward Facing Camera button on the apps menu.
- Press the TrailCam button on the Off Road Pages.
- Press the Off Road+ button when “Auto Launch Off Road+” (if equipped) has been selected under camera settings.

The TrailCam view can also be activated by pressing the  icon on the Back Up Camera view. The Back Up Camera view can also be activated by pressing the  icon on the TrailCam view.

When the vehicle is shifted out of REVERSE with Camera Delay turned off and TrailCam view is active, the TrailCam mode is exited and the previous screen appears again.

When the vehicle is shifted out of REVERSE with Camera Delay turned on and the TrailCam view is active, the TrailCam image will be displayed for up to 10 seconds unless the vehicle speed exceeds 8 mph (13 km/h), the transmission is shifted into PARK, the ignition is placed in the OFF position, or the touchscreen button X to disable display of the TrailCam view is pressed.

Whenever the TrailCam image is activated through the Manual Activation Methods, and the vehicle speed is greater than or equal to 8 mph (13 km/h), a display timer for the image is initiated. The image will continue to be displayed until the display timer exceeds 10 seconds.

#### NOTE:

- If the vehicle speed remains below 8 mph (13 km/h) while in 2WD or 4WD High, the TrailCam image will be displayed continuously until deactivated via the touchscreen button X, the transmission is shifted into PARK, or the ignition is placed in the OFF position.
- The touchscreen button X to disable the display of the camera image is made available ONLY when the vehicle is not in REVERSE.
- The TrailCam view will stay active regardless of the vehicle speed and time while in 4WD Low.

#### Cleaning The TrailCam

Press and hold the Clean Camera soft button located on the TrailCam view to wash the TrailCam. Washer fluid will stop when the button is released.

- The camera can be washed up to 20 seconds at a time while holding the button.
- The Clean Camera system is not available when windshield washing is in process.

When enabled, active dynamic Tire Lines are projected on the ground plane of the TrailCam view based on the steering wheel position.

## REFUELING THE VEHICLE — GASOLINE ENGINE (IF EQUIPPED)

### FUEL FILLER CAP

The fuel filler cap is located on the driver's side of the vehicle. If the fuel filler cap is lost or damaged, be sure the replacement cap is the correct one for this vehicle.

1. Open the fuel filler door.

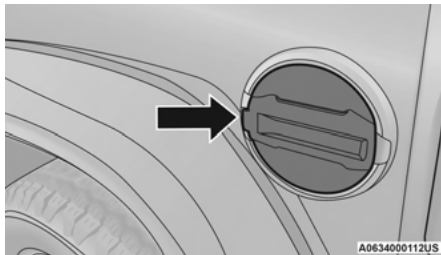

Fuel Filler Door

2. Remove the fuel cap by rotating it counter-clockwise.

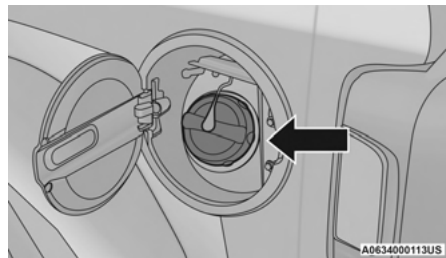

Fuel Filler Cap

3. Fully insert the fuel nozzle into the filler pipe.
4. Fill the vehicle with fuel.

#### NOTE:

- When the fuel nozzle “clicks” or shuts off, the fuel tank is full.
  - Wait five seconds before removing the fuel nozzle to allow excess fuel to drain from the nozzle.
5. Remove the fuel nozzle, reinstall fuel cap and close fuel filler door.

#### WARNING!

- Never have any smoking materials lit in or near the vehicle when the fuel door is open or the tank is being filled.

(Continued)

**WARNING!**

- Never add fuel when the engine is running. This is in violation of most state and federal fire regulations and may cause the Malfunction Indicator Light to turn on.
- A fire may result if fuel is pumped into a portable container that is inside of a vehicle. You could be burned. Always place fuel containers on the ground while filling.

**CAUTION!**

- Damage to the fuel system or emission control system could result from using an improper fuel filler cap. A poorly fitting cap could let impurities into the fuel system. Also, a poorly fitting aftermarket cap can cause the Malfunction Indicator Light (MIL) to illuminate, due to fuel vapors escaping from the system.
- To avoid fuel spillage and overfilling, do not “top off” the fuel tank after filling.

**NOTE:**

- When the fuel nozzle “clicks” or shuts off, the fuel tank is full.
- Tighten the fuel filler cap about a quarter turn until you hear one click. This is an indication that the cap is properly tightened.

- If the fuel filler cap is not tightened properly, the MIL will come on. Be sure the cap is tightened every time the vehicle is refueled.

**LOOSE FUEL FILLER CAP MESSAGE**

After fuel has been added, the vehicle diagnostic system can determine if the fuel filler cap is possibly loose, improperly installed, or damaged. If the system detects a malfunction, the “gASCAP” message will display in the odometer display. Tighten the gas cap until a “clicking” sound is heard. This is an indication that the gas cap is properly tightened. Push the odometer reset button to turn the message off. If the problem persists, the message will appear the next time the vehicle is started. This might indicate a damaged cap. If the problem is detected twice in a row, the system will turn on the MIL. Resolving the problem will turn the MIL off.

**REFUELING THE VEHICLE — DIESEL ENGINE (IF EQUIPPED)**

The fuel filler cap is located on the driver's side of the vehicle. If the fuel filler cap is lost or damaged, be sure the replacement cap is the correct one for this vehicle.

1. Open the fuel filler door.

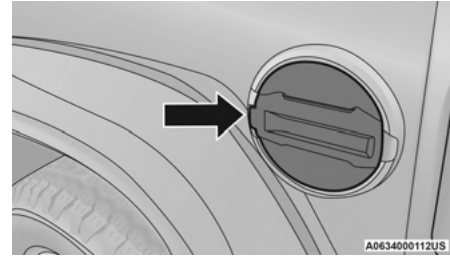
**Fuel Filler Door**

2. Remove the fuel cap by rotating it counter-clockwise.

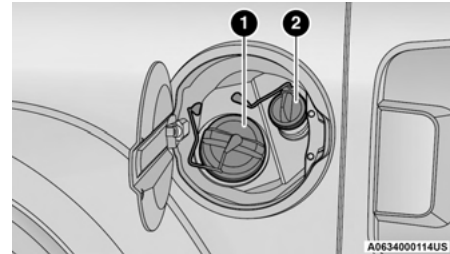
**Fuel and Diesel Exhaust Fluid (DEF) Fill Location**

- 1 — Diesel Fuel Filler
- 2 — DEF Filler

3. Fully insert the fuel nozzle into the filler pipe.
4. Fill the vehicle with fuel.

**NOTE:**

- When the fuel nozzle “clicks” or shuts off, the fuel tank is full.
  - Wait five seconds before removing the fuel nozzle to allow excess fuel to drain from the nozzle.
5. Remove the fuel nozzle, reinstall fuel cap and close fuel filler door.

**NOTE:**

Tighten the fuel filler cap about a quarter turn until you hear one click. This is an indication that the cap is properly tightened.

**CAUTION!**

For diesel engines, only use diesel fuel for motor vehicles in accordance with ASTM D-975 Grade S15 specifications. The use of other products or mixtures may damage the engine beyond repair and consequently void the warranty, due to the damage caused. If you accidentally introduce other types of fuel into the tank, do not start the engine. Empty the tank. If the engine has been run for even an extremely limited amount of time, you must not only drain the fuel tank, but the rest of the supply circuit as well.

**AVOID USING CONTAMINATED FUEL**

Fuel that is contaminated by water or dirt can cause severe damage to the engine fuel system. Proper maintenance of the engine fuel filter and fuel tank is essential see [↪](#) page 362.

**BULK FUEL STORAGE — DIESEL FUEL**

If you store quantities of fuel, good maintenance of the stored fuel is also essential. Fuel contaminated with water will promote the growth of “microbes.” These microbes form “slime” that will clog the fuel filtration system and lines. Drain condensation from the supply tank and change the line filter on a regular basis.

**NOTE:**

When a diesel engine is allowed to run out of fuel, air is pulled into the fuel system.

If the vehicle will not start see [↪](#) page 364.

**WARNING!**

Do not open the high pressure fuel system with the engine running. Engine operation causes high fuel pressure. High pressure fuel spray can cause serious injury or death.

**DIESEL EXHAUST FLUID**

Your vehicle is equipped with a Selective Catalytic Reduction (SCR) system to meet the very stringent diesel emissions standards required by the Environmental Protection Agency.

The purpose of the SCR system is to reduce levels of NO<sub>x</sub> (oxides of nitrogen emitted from engines) that are harmful to our health and the environment to a near-zero level. A small quantity of Diesel Exhaust Fluid (DEF) is injected into the exhaust upstream of a catalyst where, when vaporized, it converts smog-forming nitrogen oxides (NO<sub>x</sub>) into harmless nitrogen (N<sub>2</sub>) and water vapor (H<sub>2</sub>O), two natural components of the air we breathe. You can operate with the comfort that your vehicle is contributing to a cleaner, healthier world environment for this and generations to come.

**System Overview**

This vehicle is equipped with a Diesel Exhaust Fluid (DEF) injection system and a Selective Catalytic Reduction (SCR) catalyst to meet the emission requirements.

The DEF injection system consists of the following components:

- DEF tank
- DEF pump
- DEF injector

- Electronically-heated DEF Lines
- NOx sensors
- Temperature sensors
- SCR catalyst

The DEF injection system and SCR catalyst enable the achievement of diesel emission requirements; while maintaining outstanding fuel economy, drivability, torque and power ratings.

For system messages and warnings see [page 120](#).

#### NOTE:

- Your vehicle is equipped with a DEF injection system. You may occasionally hear an audible clicking noise from under the vehicle at a stop. This is normal operation.
- The DEF pump will run for a period of time after engine shutdown to purge the DEF system. This is normal operation and may be audible from the rear of the vehicle.

### Diesel Exhaust Fluid Storage

Diesel Exhaust Fluid (DEF) is considered a very stable product with a long shelf life. If DEF is kept in temperatures between 10° and 90°F (-12° and 32°C), it will last a minimum of one year.

DEF is subject to freezing at the lowest temperatures. For example, DEF may freeze at temperatures at or below 12°F (-11°C). The system has been designed to operate in this environment.

#### NOTE:

When working with DEF, it is important to know that:

- Any containers or parts that come into contact with DEF must be DEF compatible (plastic or stainless steel). Copper, brass, aluminum, iron or non-stainless steel should be avoided as they are subject to corrosion by DEF.
- If DEF is spilled, it should be wiped up completely.

### Adding Diesel Exhaust Fluid

The DEF gauge (located on the instrument cluster display) will display the level of DEF remaining in the tank [page 120](#).

#### NOTE:

Driving conditions (altitude, vehicle speed, load, etc.) will affect the amount of DEF that is used in your vehicle.

### DEF FILL PROCEDURE

#### NOTE:

For the correct DEF fluid type see [page 424](#).

1. Remove cap from DEF fill inlet (located in fuel door).

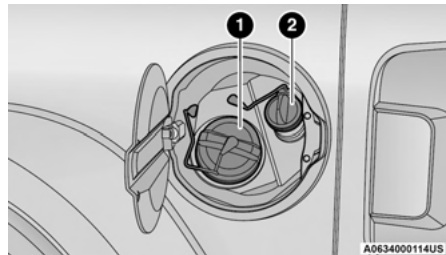

**Fuel and Diesel Exhaust Fluid Fill Location**

- 1 — Diesel Fuel Filler
- 2 — Diesel Exhaust Fluid Filler

2. Insert DEF fill adapter/nozzle into DEF fill inlet.

#### NOTE:

- The DEF gauge may take up to five seconds to update after adding a gallon or more of Diesel Exhaust Fluid (DEF) to the DEF tank. If you have a fault related to the DEF

system, the gauge may not update to the new level. See an authorized dealer for service.

- The DEF gauge may also not immediately update after a refill if the temperature of the DEF fluid is below 12° F (-11° C). The DEF tank heater will possibly warm up the DEF fluid and allow the gauge to update after a period of run time. Under very cold conditions, it is possible that the gauge may not reflect the new fill level for several drives.
- Excessive overfilling of the DEF tank can result in a MIL lamp/fault code and inaccurate level readings.

#### Refilling With Nozzles

You can fill up at any DEF distributor.

Proceed as follows:

- Insert the DEF nozzle in the filler, start refilling and stop refilling at the first shut-off (the shut-off indicates that the DEF tank is full). Do not proceed with the refilling, to prevent spillage of DEF.
- Extract the nozzle.

#### Refilling With Containers

Proceed as follows:

- Check the expiration date.
- Read the advice for use on the label before pouring the content of the bottle into the DEF tank.
- If systems which cannot be screwed in (e.g. tanks) are used for refilling, after the indication appears on the instrument panel display → page 116 fill the DEF tank with no more than 2 gallons (8 liters).
- If containers which can be screwed to the filler are used, the reservoir is full when the DEF level in the container stops pouring out. Do not proceed further.

#### CAUTION!

- To avoid DEF spillage, and possible damage to the DEF tank from overfilling, do not "top off" the DEF tank after filling.
- DO NOT OVERFILL. DEF will freeze below 12°F (-11°C). The DEF system is designed to work in temperatures below the DEF freezing point, however, if the tank is overfilled and freezes, the system could be damaged.

(Continued)

#### CAUTION!

- When DEF is spilled, clean the area immediately with water and use an absorbent material to soak up the spills on the ground.
- Do not attempt to start your engine if DEF is accidentally added to the diesel fuel tank as it can result in severe damage to your engine, including but not limited to failure of the fuel pump and injectors.
- Never add anything other than DEF to the tank – especially any form of hydrocarbon such as diesel fuel, fuel system additives, gasoline, or any other petroleum-based product. Even a very small amount of these, less than 100 parts per million or less than 1 oz. per 78 gallons (295 liters) will contaminate the entire DEF system and will require replacement. If owners use a container, funnel or nozzle when refilling the tank, it should either be new or one that has only been used for adding DEF. Mopar® provides an attachable nozzle with its DEF for this purpose.



- Stop filling the DEF tank immediately when any of the following happen: DEF stops flowing from the fill bottle into the DEF fill inlet, DEF splashes out the fill inlet, or a DEF pump nozzle automatically shuts off.
- Reinstall cap onto DEF fill inlet.

## VEHICLE LOADING

### CERTIFICATION LABEL

As required by National Highway Traffic Safety Administration regulations, your vehicle has a certification label affixed to the driver's side door or pillar.

This label contains the month and year of manufacture, Gross Vehicle Weight Rating (GVWR), Gross Axle Weight Rating (GAWR) front and rear, and Vehicle Identification Number (VIN). A Month-Day-Hour (MDH) number is included on this label and indicates the Month, Day and Hour of manufacture. The bar code that appears on the bottom of the label is your VIN.

### Gross Vehicle Weight Rating (GVWR)

The GVWR is the total permissible weight of your vehicle including driver, passengers, vehicle, options and cargo. The label also specifies maximum capacities of front and rear axle systems (GAWR). Total load must be limited so GVWR and front and rear GAWR are not exceeded.

### Payload

The payload of a vehicle is defined as the allowable load weight a truck can carry, including the weight of the driver, all passengers, options and cargo.

### Gross Axle Weight Rating (GAWR)

The GAWR is the maximum permissible load on the front and rear axles. The load must be distributed in the cargo area so that the GAWR of each axle is not exceeded.

Each axle GAWR is determined by the components in the system with the lowest load carrying capacity (axle, springs, tires or wheels). Heavier axles or suspension components sometimes specified by purchasers for increased durability does not necessarily increase the vehicle's GVWR.

### Tire Size

The tire size on the Vehicle Certification Label represents the actual tire size on your vehicle. Replacement tires must be equal to the load capacity of this tire size.

### Rim Size

This is the rim size that is appropriate for the tire size listed.

### Inflation Pressure

This is the cold tire inflation pressure for your vehicle for all loading conditions up to full GAWR.

### Curb Weight

The curb weight of a vehicle is defined as the total weight of the vehicle with all fluids, including vehicle fuel, at full capacity conditions, and with no occupants or cargo loaded into the vehicle. The front and rear curb weight values are determined by weighing your vehicle on a commercial scale before any occupants or cargo are added.

### Loading

The actual total weight and the weight of the front and rear of your vehicle at the ground can best be determined by weighing it when it is loaded and ready for operation.

The entire vehicle should first be weighed on a commercial scale to ensure that the GVWR has not been exceeded. The weight on the front and rear of the vehicle should then be determined separately to be sure that the load is properly distributed over the front and rear axle. Weighing the vehicle may show that the GAWR of either the front or rear axles has been exceeded but the total load is within the specified GVWR. If so, weight must be shifted from front to rear or rear to front as appropriate until the specified weight limitations are met. Store the heavier items down low and be sure that the weight is distributed equally. Stow all loose items securely before driving.

Improper weight distributions can have an adverse effect on the way your vehicle steers and handles and the way the brakes operate.

### CAUTION!

Do not load your vehicle any heavier than the GVWR or the maximum front and rear GAWR. If you do, parts on your vehicle can break, or it can change the way your vehicle handles. This could cause you to lose control. Overloading can shorten the life of your vehicle.

## TRAILER TOWING

In this section you will find safety tips and information on limits to the type of towing you can reasonably do with your vehicle. Before towing a trailer, carefully review this information to tow your load as efficiently and safely as possible.

To maintain the New Vehicle Limited Warranty coverage, follow the requirements and recommendations in this manual concerning vehicles used for trailer towing.

### COMMON TOWING DEFINITIONS

The following trailer towing related definitions will assist you in understanding the following information:

#### Gross Vehicle Weight Rating (GVWR)

The GVWR is the total allowable weight of your vehicle. This includes driver, passengers, cargo and tongue weight. The total load must be limited so that you do not exceed the GVWR ➤ page 191.

#### Gross Trailer Weight (GTW)

The GTW is the weight of the trailer plus the weight of all cargo, consumables and equipment (permanent or temporary) loaded in or on the trailer in its "loaded and ready for operation" condition.

The recommended way to measure GTW is to put your fully loaded trailer on a vehicle scale. The entire weight of the trailer must be supported by the scale.

#### Gross Combination Weight Rating (GCWR)

The GCWR is the total permissible weight of your vehicle and trailer when weighed in combination.

#### Gross Axle Weight Rating (GAWR)

The GAWR is the maximum capacity of the front and rear axles. Distribute the load over the front and rear axles evenly. Make sure that you do not exceed either front or rear GAWR ➤ page 191.

### WARNING!

It is important that you do not exceed the maximum front or rear GAWR. A dangerous driving condition can result if either rating is exceeded.

#### Tongue Weight (TW)

The TW is the downward force exerted on the hitch ball by the trailer. You must consider this as part of the load on your vehicle.

#### Frontal Area

The frontal area is the maximum height multiplied by the maximum width of the front of a trailer.

#### Trailer Sway Control (TSC) – If Equipped

The TSC is a telescoping link that can be installed between the hitch receiver and the trailer tongue. It typically provides adjustable friction associated with the telescoping motion to dampen any unwanted trailer swaying motions while traveling.

#### Weight-Carrying Hitch

A weight-carrying hitch supports the trailer tongue weight, just as if it were luggage located at a hitch ball or some other connecting point of the vehicle. These kinds of hitches are commonly used to tow small and medium sized trailers.

## Weight-Distributing Hitch

A Weight-Distributing Hitch works by applying leverage through spring (load) bars. They are typically used for heavier loads to distribute trailer tongue weight to the tow vehicle's front axle and the trailer axle(s). When used in accordance with the manufacturer's directions, it provides for a more level ride, offering more consistent steering and brake control thereby enhancing towing safety. The addition of a friction/hydraulic sway control also dampens sway caused by traffic and crosswinds and contributes positively to tow vehicle and trailer stability. Trailer sway control and a Weight-Distributing (load equalizing) Hitch are recommended for heavier Tongue Weights (TW)

and may be required depending on vehicle and trailer configuration/loading to comply with Gross Axle Weight Rating (GAWR) requirements.

### WARNING!

- An improperly adjusted Weight Distributing Hitch system may reduce handling, stability, braking performance, and could result in a collision.
- Weight-Distributing Hitch Systems may not be compatible with surge brake couplers. Consult with your hitch and trailer manufacturer or a reputable Recreational Vehicle dealer for additional information.

## TRAILER HITCH CLASSIFICATION

The following chart provides the industry standard for the maximum trailer weight a given trailer hitch class can tow and should be used to assist you in selecting the correct trailer hitch for your intended towing condition.

### Trailer Hitch Classification Definitions

Class	Max. Trailer Hitch Industry Standards
Class I - Light Duty	2,000 lb (907 kg)
Class II - Medium Duty	3,500 lb (1,587 kg)
Class III - Heavy Duty	6,000 lb (2,721 kg)
Class IV - Extra Heavy Duty	10,000 lb (4,535 kg)

Refer to the "Trailer Towing Weights (Maximum Trailer Weight Ratings)" chart for the Maximum Gross Trailer Weight (GTW) towable for your given drivetrain.

All trailer hitches should be professionally installed on your vehicle.

## TRAILER TOWING WEIGHTS (MAXIMUM TRAILER WEIGHT RATINGS)

Engine/Transmission	Model	GCWR	Frontal Area	Maximum GTW	Maximum Trailer TW (See Note)
2.0L	Two-Door	8,016 lb (3,636 kg)	20 ft <sup>2</sup> (1.86 m <sup>2</sup> )	2,000 lb (907 kg)	200 lb (91 kg)
	Four-Door	8,117 lb (3,682 kg)	30 ft <sup>2</sup> (2.79 m <sup>2</sup> )	3,500 lb (1,587 kg)	350 lb (158 kg)
3.6L	Two-Door	8,016 lb (3,636 kg)	20 ft <sup>2</sup> (1.86 m <sup>2</sup> )	2,000 lb (907 kg)	200 lb (91 kg)
	Four-Door	8,117 lb (3,682 kg)	30 ft <sup>2</sup> (2.79 m <sup>2</sup> )	3,500 lb (1,587 kg)	350 lb (158 kg)
3.0L Diesel	Four-Door	8,427 lb (3,822 kg)	30 ft <sup>2</sup> (2.79 m <sup>2</sup> )	3,500 lb (1,587 kg)	350 lb (158 kg)

Refer to local laws for maximum trailer towing speeds.

### NOTE:

The trailer tongue weight must be considered as part of the combined weight of occupants and cargo (i.e., the GVWR), and the GVWR should never exceed the weight referenced on the Tire and Loading Information placard → page 391.

### TRAILER AND TONGUE WEIGHT

Never exceed the maximum tongue weight stamped on your bumper or trailer hitch.

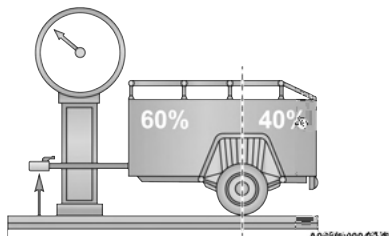

Weight Distribution

Consider the following items when computing the weight on the rear axle of the vehicle:

- The tongue weight of the trailer.
- The weight of any other type of cargo or equipment put in or on your vehicle.
- The weight of the driver and all passengers.

### NOTE:

Remember that everything put into or on the trailer adds to the load on your vehicle. Also, additional factory-installed options or dealer-installed options must be considered as part of the total load on your vehicle. Refer to the “Tire And Loading Information” placard for the maximum combined weight of occupants and cargo for your vehicle.

## TOWING REQUIREMENTS

To promote proper break-in of your new vehicle drivetrain components, the following guidelines are recommended:

### WARNING!

Improper towing can lead to a collision. Follow these guidelines to make your trailer towing as safe as possible:

- Make certain that the load is secured in the trailer and that it will not shift during travel. When trailering cargo that is not fully secured, dynamic load shifts can occur that may be difficult for the driver to control. You could lose control of your vehicle and have a collision.
- When hauling cargo, or towing a trailer, do not overload your vehicle or trailer. Overloading can cause a loss of control, poor performance, or damage to brakes, axle, engine, transmission, steering, suspension, chassis structure, or tires.
- Safety chains must always be used between your vehicle and trailer. Always connect the chains to the frame or hook retainers of the vehicle hitch. Cross the chains under the trailer tongue and allow enough slack for turning corners.

*(Continued)*

### WARNING!

- Vehicles with trailers should not be parked on a grade. When parking, apply the parking brake on the tow vehicle. Put the tow vehicle transmission in PARK. Always block or "chock" the trailer wheels.
- GCWR must not be exceeded.
- Total weight must be distributed between the tow vehicle and the trailer such that the following four ratings are not exceeded:
  - GVWR
  - GTW
  - GAWR
  - Tongue weight rating for the trailer hitch utilized.

### CAUTION!

- Do not tow a trailer at all during the first 500 miles (805 km) the new vehicle is driven. The engine, axle or other parts could be damaged.

*(Continued)*

### CAUTION!

- Then, during the first 500 miles (805 km) that a trailer is towed, do not drive over 50 mph (80 km/h) and do not make starts at full throttle. This helps the engine and other parts of the vehicle wear in at the heavier loads.

## Towing Requirements — Tires

- Proper tire inflation pressures are essential to the safe and satisfactory operation of your vehicle.
- Check the trailer tires for proper tire inflation pressures before trailer usage.
- Check for signs of tire wear or visible tire damage before towing a trailer.
- Replacing tires with a higher load carrying capacity will not increase the vehicle's GVWR and GAWR limits.
- For further information ↗ page 391.

## Towing Requirements – Trailer Brakes

- Do **not** interconnect the hydraulic brake system or vacuum system of your vehicle with that of the trailer. This could cause inadequate braking and possible personal injury.
- An electronically actuated trailer brake controller is required when towing a trailer with electronically actuated brakes. When towing a trailer equipped with a hydraulic surge actuated brake system, an electronic brake controller is not required.
- Trailer brakes are recommended for trailers over 1,000 lb (453 kg) and required for trailers in excess of 2,000 lb (907 kg).

### WARNING!

- Do not connect trailer brakes to your vehicle's hydraulic brake lines. It can overload your brake system and cause it to fail. You might not have brakes when you need them and could have an accident.
- Towing any trailer will increase your stopping distance. When towing, you should allow for additional space between your vehicle and the vehicle in front of you. Failure to do so could result in an accident.

### CAUTION!

If the trailer weighs more than 1,000 lb (453 kg) loaded, it should have its own brakes and they should be of adequate capacity. Failure to do this could lead to accelerated brake lining wear, higher brake pedal effort, and longer stopping distances.

## Towing Requirements – Trailer Lights And Wiring

Whenever you pull a trailer, regardless of the trailer size, stop lights and turn signals on the trailer are required for motoring safety.

The Trailer Tow Package may include a four- and seven-pin wiring harness. Use a factory approved trailer harness and connector.

### NOTE:

Do not cut or splice wiring into the vehicle's wiring harness.

The electrical connections are all complete to the vehicle but you must mate the harness to a trailer connector. Refer to the following illustrations.

### NOTE:

- Disconnect trailer wiring connector from the vehicle before launching a boat (or any other device plugged into vehicle's electrical connect) into water.
- Be sure to reconnect once clear from water area.

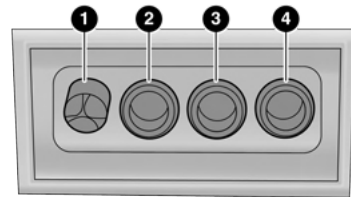

M0636000043US

**Four-Pin Connector**

- 1 – Ground
- 2 – Park
- 3 – Left Stop/Turn
- 4 – Right Stop/Turn

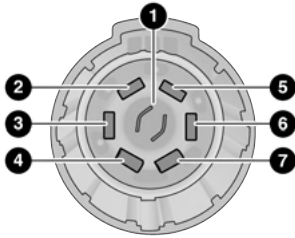

Seven-Pin Connector

A063600085US

- 1 – Backup Lamps
- 2 – Running Lamps
- 3 – Left Stop/Turn
- 4 – Ground
- 5 – Battery
- 6 – Right Stop/Turn
- 7 – Electric Brakes

## TOWING TIPS

Before setting out on a trip, practice turning, stopping and backing the trailer in an area away from heavy traffic.

If using a manual transmission vehicle for trailer towing, all starts must be in FIRST gear to avoid excessive clutch slippage.

## Automatic Transmission – If Equipped

Select the DRIVE range when towing. The transmission controls include a drive strategy to avoid frequent shifting when towing. However, if frequent shifting does occur while in DRIVE, you can use the AutoStick shift control to manually select a lower gear.

### NOTE:

Using a lower gear while operating the vehicle under heavy loading conditions, will improve performance and extend transmission life by reducing excessive shifting and heat build-up. This action will also provide better engine braking.

## AutoStick – If Equipped

- When using the AutoStick shift control, select the highest gear that allows for adequate performance and avoids frequent downshifts. For example, choose “5” if the desired speed can be maintained. Choose “4” or “3” if needed to maintain the desired speed.
- To prevent excess heat generation, avoid continuous driving at high RPM. Return to a higher gear or vehicle speed when grade and road conditions allow.

## Cruise Control – If Equipped

- Do not use in hilly terrain or with heavy loads.
- When using the Cruise Control, if you experience speed drops greater than 10 mph (16 km/h), disengage until you can get back to cruising speed.
- Use Cruise Control in flat terrain and with light loads to maximize fuel efficiency.

## RECREATIONAL TOWING (BEHIND MOTORHOME)

### TOWING THIS VEHICLE BEHIND ANOTHER VEHICLE

Towing Condition	Wheels OFF the Ground	Four-Wheel Drive Models
Flat Tow	NONE	<b>See Instructions</b> <ul style="list-style-type: none"> <li>● Automatic transmission in PARK.</li> <li>● Manual transmission in gear (NOT in NEUTRAL [N]).</li> <li>● Transfer case in (N) Neutral.</li> <li>● Tow in forward direction.</li> </ul>
Dolly Tow	Front	NOT ALLOWED
	Rear	NOT ALLOWED
On Trailer	ALL	OK

**NOTE:**

When towing your vehicle, always follow applicable state and provincial laws. Contact state and provincial Highway Safety offices for additional details.

### RECREATIONAL TOWING — FOUR-WHEEL DRIVE MODELS

**NOTE:**

The transfer case must be shifted into (N) Neutral, automatic transmission must be in PARK, and manual transmission must be in gear (NOT in NEUTRAL) for recreational towing.

**CAUTION!**

- DO NOT dolly tow any 4WD vehicle. Towing with only one set of wheels on the ground (front or rear) will cause severe transmission and/or transfer case damage. Tow with all four wheels either ON the ground, or OFF the ground (using a vehicle trailer).

*(Continued)*

**CAUTION!**

- Tow only in the forward direction. Towing this vehicle backwards can cause severe damage to the transfer case.
- Automatic transmissions must be placed in PARK for recreational towing.

*(Continued)*



**CAUTION!**

- Manual transmissions must be placed in gear (not in NEUTRAL) for recreational towing.
- Before recreational towing, perform the procedure outlined under “Shifting Into (N) Neutral” to be certain that the transfer case is fully in (N) Neutral. Otherwise, internal damage will result.
- Towing this vehicle in violation of the above requirements can cause severe transmission and/or transfer case damage. Damage from improper towing is not covered under the New Vehicle Limited Warranty.
- Do not use a fascia/bumper-mounted clamp-on tow bar on your vehicle. The bumper face bar will be damaged.

**Shifting Into (N) Neutral**

Use the following procedure to prepare your vehicle for recreational towing:

**WARNING!**

You or others could be injured or killed if you leave the vehicle unattended with the transfer case in the (N) Neutral position without first fully engaging the parking brake. The transfer case (N) Neutral position disengages both the front and rear driveshafts from the powertrain, and will allow the vehicle to roll, even if the automatic transmission is in PARK (or manual transmission is in gear). The parking brake should always be applied when the driver is not in the vehicle.

**WARNING!**

You or others could be injured or killed if you leave the vehicle unattended with the transfer case in the (N) Neutral position without first fully engaging the parking brake. The transfer case (N) Neutral position disengages both the front and rear driveshafts from the powertrain, and will allow the vehicle to roll, even if the automatic transmission is in PARK. The parking brake should always be applied when the driver is not in the vehicle.

**CAUTION!**

It is necessary to follow these steps to be certain that the transfer case is fully in (N) Neutral before recreational towing to prevent damage to internal parts.

1. Bring the vehicle to a complete stop on level ground.
2. Press and hold the brake pedal.
3. Shift the automatic transmission into NEUTRAL or press the clutch pedal on a manual transmission.
4. Turn the engine off.
5. Shift the transfer case lever into (N) Neutral.
6. Start the engine.
7. Shift the transmission into REVERSE.
8. Release the brake pedal (and clutch pedal on manual transmissions) for five seconds and ensure that there is no vehicle movement.
9. Repeat steps seven and eight with automatic transmission in DRIVE or manual transmission in FIRST gear.
10. Turn the engine off.

11. Firmly apply the parking brake.
12. Shift the transmission into PARK or place manual transmission in gear (NOT in NEUTRAL).

### CAUTION!

Damage to the transmission may occur if the transmission is shifted into PARK with the transfer case in (N) Neutral and the engine running. With the transfer case in (N) Neutral ensure that the engine is OFF before shifting the transmission into PARK.

13. Attach the vehicle to the tow vehicle using a suitable tow bar.
14. Release the parking brake.

### Shifting Out of (N) Neutral

Use the following procedure to prepare your vehicle for normal usage.

1. Bring the vehicle to a complete stop, leaving it connected to the tow vehicle.
2. Firmly apply the parking brake.
3. Start the engine.
4. Press and hold the brake pedal.
5. Shift the transmission into NEUTRAL.
6. Turn the engine off.

7. Shift the transfer case lever to the desired position.

### NOTE:

When shifting the transfer case out of (N) Neutral, the engine should remain off to avoid gear clash.

8. Shift the automatic transmission into PARK, or place manual transmission in NEUTRAL.
9. Release the brake pedal.
10. Disconnect vehicle from the tow vehicle.
11. Start the engine.
12. Press and hold the brake pedal.
13. Release the parking brake.
14. Shift the transmission into gear, release the brake pedal (and clutch pedal on manual transmissions), and check that the vehicle operates normally.

## DRIVING TIPS

### ON-ROAD DRIVING TIPS

Utility vehicles have higher ground clearance and a narrower track to make them capable of performing in a wide variety of off-road applications. Specific design characteristics give them a higher center of gravity than conventional passenger cars.

An advantage of the higher ground clearance is a better view of the road, allowing you to anticipate

problems. They are not designed for cornering at the same speeds as conventional passenger cars any more than low-slung sports cars are designed to perform satisfactorily in off-road conditions. Avoid sharp turns or abrupt maneuvers. As with other vehicles of this type, failure to operate this vehicle correctly may result in loss of control or vehicle rollover.

## OFF-ROAD DRIVING TIPS

### Side Step Removal — If Equipped

#### NOTE:

Prior to off-road usage, the side steps should be removed to prevent damage if so equipped.

1. Remove both nuts and bolt from the underside of the vehicle for each bracket.

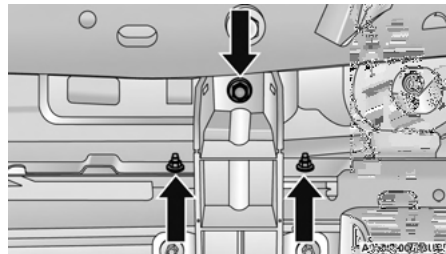

Underside Nuts

2. Remove the side step assembly.

## Bumper End Cap Removal

The end caps on your vehicle's front fascia/ bumper can be removed by following the steps below:

### NOTE:

Bumper end caps are removable on steel fascia/ bumpers only.

1. Loosen the two bolts that retain the GAWR bracket (Bolts #1 and #2) to the end cap using a T45 torx bit screw driver. Do not remove the bolts.

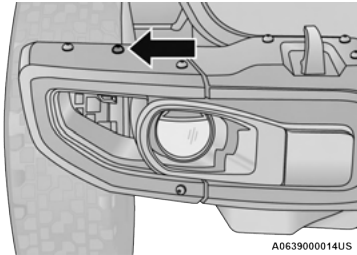

**Bolt #1**

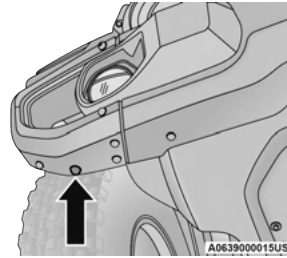

**Bolt #2**

2. Remove the remaining eight bolts.
3. Gently remove the end cap from the vehicle and store it where it will not get damaged.
4. Repeat this procedure on the other side.

## The Basics Of Off-Road Driving

You will encounter many types of terrain driving off-road. You should be familiar with the terrain and area before proceeding. There are many types of surface conditions: hard-packed dirt, gravel, rocks, grass, sand, mud, snow and ice. Every surface has a different effect on your vehicle's steering, handling and traction. Controlling your vehicle is one of the keys to successful off-road driving, so always keep a firm grip on the steering wheel and maintain a good driving posture. Avoid sudden accelerations, turns or braking. In most cases, there are no road signs, posted speed limits

or signal lights. Therefore, you will need to use your own good judgment on what is safe and what is not. When on a trail, you should always be looking ahead for surface obstacles and changes in terrain. The key is to plan your future driving route while remembering what you are currently driving over.

### NOTE:

It is recommended that the Stop/Start system be disabled during off-road use.

### WARNING!

Always wear your seat belt and firmly tie down cargo. Unsecured cargo can become projectiles in an off-road situation.

### CAUTION!

Never park your vehicle over dry grass or other combustible materials. The heat from your vehicle exhaust system could cause a fire.

## When To Use 4L Range

When off-road driving, shift into 4L for additional traction and control on slippery or difficult terrain, ascending or descending steep hills, and to increase low speed pulling power. This range should be limited to extreme situations such as deep snow, mud, steep inclines, or sand where

additional low speed pulling power is needed. Vehicle speeds in excess of 25 mph (40 km/h) should be avoided when in 4L.

**CAUTION!**

Do not use 4L when operating the vehicle on dry pavement. Driveline hardware damage can result.

### Simultaneous Brake And Throttle Operation

Many off-road driving conditions require the simultaneous use of the brake and throttle (two-footed driving). When climbing rocks, logs, or other stepped objects, using light brake pressure with light throttle will keep the vehicle from jerking or lurching. This technique is also used when you need to stop and restart a vehicle on a steep incline.

### Driving In Snow, Mud And Sand

#### SNOW

In heavy snow or for additional control and traction at slower speeds, shift the transmission into a low gear and the transfer case into 4L if necessary. Do not shift to a lower gear than necessary to maintain headway. Over-revving the engine can spin the wheels and traction will be lost. If you start to slow to a stop, try turning your steering wheel no more

than a 1/4 turn quickly back and forth, while still applying throttle. This will allow the tires to get fresh traction and help maintain your momentum.

**CAUTION!**

On icy or slippery roads, do not downshift at high engine RPM or vehicle speeds, because engine braking may cause skidding and loss of control.

#### MUD

Deep mud creates a great deal of suction around the tires and is very difficult to get through. You should use DRIVE, with the transfer case in the 4L position to maintain your momentum. If you start to slow to a stop, try turning your steering wheel no more than a 1/4 turn quickly back and forth for additional traction. Mud holes pose an increased threat of vehicle damage and getting stuck. They are normally full of debris from previous vehicles getting stuck. As a good practice before entering any mud hole, get out and determine how deep it is, if there are any hidden obstacles and if the vehicle can be safely recovered if stuck.

#### SAND

Soft sand is very difficult to travel through with full tire pressure. When crossing soft, sandy spots in a trail, maintain your vehicle's momentum and do not stop. The key to driving in soft sand is using the appropriate tire pressure, accelerating slowly,

avoiding abrupt maneuvers and maintaining the vehicle's momentum. If you are going to be driving on large soft sandy areas or dunes, reduce your tire pressure to a minimum of 15 psi (103 kPa) to allow for a greater tire surface area. Reduced tire pressure will drastically improve your traction and handling while driving on the soft sand, but you must return the tires to normal air pressure before driving on pavement or other hard surfaces. Be sure you have a way to reinflate the tires prior to reducing the pressure.

**CAUTION!**

Reduced tire pressures may cause tire unseating and total loss of air pressure. To reduce the risk of tire unseating, while at a reduced tire pressure, reduce your speed and avoid sharp turns or abrupt maneuvers.

### Crossing Obstacles (Rocks And Other High Points)

While driving off-road, you will encounter many types of terrain. These varying types of terrain bring different types of obstacles. Before proceeding, review the path ahead to determine the correct approach and your ability to safely recover the vehicle if something goes wrong. Keeping a firm grip on the steering wheel, bring the vehicle to a complete stop and then inch the vehicle forward

until it makes contact with the object. Apply the throttle lightly while holding a light brake pressure and ease the vehicle up and over the object.

### WARNING!

Crossing obstacles can cause abrupt steering system loading which could cause you to lose control of your vehicle.

### USING A SPOTTER

There are many times where it is hard to see the obstacle or determine the correct path. Determining the correct path can be extremely difficult when you are confronting many obstacles. In these cases have someone guide you over, through, or around the obstacle. Have the person stand a safe distance in front of you where they can see the obstacle, watch your tires and undercarriage, and guide you through.

### CROSSING LARGE ROCKS

When approaching large rocks, choose a path which ensures you drive over the largest of them with your tires. This will lift your undercarriage over the obstacle. The tread of the tire is tougher and thicker than the side wall and is designed to take the abuse. Always look ahead and make every effort to cross the large rocks with your tires.

### CAUTION!

- Never attempt to straddle a rock that is large enough to strike your axles or undercarriage.
- Never attempt to drive over a rock which is large enough to contact the door sills.

### CROSSING A RAVINE, GULLY, DITCH, WASHOUT OR RUT

When crossing a ravine, gully, ditch, washout or a large rut, the angled approach is the key to maintaining your vehicle's mobility. Approach these obstacles at a 45-degree angle and let each tire go through the obstacle independently. You need to use caution when crossing large obstacles with steep sides. Do not attempt to cross any large obstacle with steep sides at an angle great enough to put the vehicle at risk of a rollover. If you get caught in a rut, dig a small trench to the right or left at a 45-degree angle ahead of the front tires. Use the removed dirt to fill the rut ahead of the turnout you just created. You should now be able to drive out following the trench you just created at a 45-degree angle.

### WARNING!

There is an increased risk of rollover when crossing an obstacle, at any angle, with steep sides.

### CROSSING LOGS

To cross a log, approach it at a slight angle (approximately 10 to 15 degrees). This allows one front tire to be on top of the log while the other just starts to climb the log. While climbing the log, modulate your brake and accelerator to avoid spinning the log out from under your tires. Then ease the vehicle off the log using your brakes.

### CAUTION!

Do not attempt to cross a log with a greater diameter than the running ground clearance or the vehicle will become high-centered.

### GETTING HIGH-CENTERED

If you get hung up or high-centered on an object, get out of the vehicle and try to determine what the vehicle is hung up on, where it is contacting the underbody and what is the best direction to recover the vehicle. Depending on what you are in contact with, jack the vehicle up and place a few rocks under the tires so the weight is off of the high point when you let the vehicle down. You can also try rocking the vehicle or winching the vehicle off the object.

### CAUTION!

Winching or rocking the vehicle off hard objects increases the risk of underbody damage.

## Hill Climbing

Hill climbing requires good judgment and a good understanding of your abilities and your vehicle's limitations. Hills can cause serious problems. Some are just too steep to climb and should not be attempted. You should always feel confident with the vehicle and your abilities. You should always climb hills straight up and down. Never attempt to climb a hill on an angle.

### BEFORE CLIMBING A STEEP HILL

As you approach a hill, consider its grade or steepness. Determine if it is too steep. Look to see what the traction is on the hill side trail. Is the trail straight up and down? What is on top and the other side? Are there ruts, rocks, branches or other obstacles on the path? Can you safely recover the vehicle if something goes wrong? If everything looks good and you feel confident, shift the transmission into a lower gear with 4L engaged, and proceed with caution, maintaining your momentum as you climb the hill.

### DRIVING UP HILL

Once you have determined your ability to proceed and have shifted into the appropriate gear, line your vehicle up for the straightest possible run. Accelerate with an easy constant throttle and apply more power as you start up the hill. Do not race forward into a steep grade; the abrupt change of

grade could cause you to lose control. If the front end begins to bounce, ease off the throttle slightly to bring all four tires back on the ground. As you approach the crest of the hill, ease off the throttle and slowly proceed over the top. If the wheels start to slip as you approach the crest of a hill, ease off the accelerator and maintain headway by turning the steering wheel no more than a 1/4 turn quickly back and forth. This will provide a fresh "bite" into the surface and will usually provide enough traction to complete the climb. If you do not make it to the top, place the vehicle in REVERSE and back straight down the grade using engine resistance along with the vehicle brakes.

#### WARNING!

Never attempt to climb a hill at an angle or turn around on a steep grade. Driving across an incline increases the risk of a rollover, which may result in severe injury.

### DRIVING DOWNHILL

Before driving down a steep hill, you need to determine if it is too steep for a safe descent. What is the surface traction? Is the grade too steep to maintain a slow, controlled descent? Are there obstacles? Is it a straight descent? Is there plenty of distance at the base of the hill to regain control if the vehicle descends too fast? If you feel confident in your ability to proceed, then make

sure you are in 4L and proceed with caution. Allow engine braking to control the descent and apply your brakes, if necessary, but do not allow the tires to lock.

#### WARNING!

Do not descend a steep grade in NEUTRAL. Use vehicle brakes in conjunction with engine braking. Descending a grade too fast could cause you to lose control and be seriously injured or killed.

### DRIVING ACROSS AN INCLINE

If at all possible, avoid driving across an incline. If it is necessary, know your vehicle's abilities. Driving across an incline places more weight on the downhill wheels, which increases the possibilities of a downhill slide or rollover. Make sure the surface has good traction with firm and stable soils. If possible, transverse the incline at an angle heading slightly up or down.

#### WARNING!

Driving across an incline increases the risk of a rollover, which may result in severe injury.

**IF YOU STALL OR BEGIN TO LOSE HEADWAY**

If you stall or begin to lose headway while climbing a steep hill, allow your vehicle to come to a stop and immediately apply the brake. Restart the engine and shift into REVERSE. Back slowly down the hill allowing engine braking to control the descent and apply your brakes, if necessary, but do not allow the tires to lock.

**WARNING!**

If the engine stalls or you lose headway or cannot make it to the top of a steep hill or grade, never attempt to turn around. To do so may result in tipping and rolling the vehicle, which may result in severe injury. Always back carefully straight down a hill in REVERSE. Never back down a hill in NEUTRAL using only the vehicle brakes. Never drive diagonally across a hill, always drive straight up or down.

**Driving Through Water**

Extreme care should be taken crossing any type of water. Water crossings should be avoided, if possible, and only be attempted when necessary in a safe, responsible manner. Only drive through areas which are designated and approved. Tread lightly and avoid damage to the environment. Know your vehicle's abilities and be able to recover it if something goes wrong. Never stop or shut a

vehicle off when crossing deep water unless you ingested water into the engine air intake. If the engine stalls, do not attempt to restart it. Determine if it has ingested water first. The key to any crossing is low and slow. Shift into FIRST gear (manual transmission), or DRIVE (automatic transmission), with the transfer case in the 4L position and proceed very slowly with a constant slow speed of {3 to 5 mph (5 to 8 km/h) maximum} and light throttle. Keep the vehicle moving; do not try to accelerate through the crossing. After crossing any water higher than the bottom of the axle differentials, inspect all of the vehicle fluids for signs of water ingestion.

**CAUTION!**

- Water ingestion into the axles, transmission, transfer case, engine or vehicle interior can occur if you drive too fast or through too deep of water. Water can cause permanent damage to engine, driveline or other vehicle components, and your brakes will be less effective once wet and/or muddy.
- When driving through water, do not exceed 5 mph (8 km/h). Always check water depth before entering as a precaution, and check all fluids afterward. Driving through water may cause damage that may not be covered by the New Vehicle Limited Warranty.

**BEFORE YOU CROSS ANY TYPE OF WATER**

As you approach any type of water, you need to determine if you can cross it safely and responsibly. If necessary, get out and walk through the water or probe it with a stick. You need to be sure of its depth, approach angle, current and bottom condition. Be careful of murky or muddy waters; check for hidden obstacles. Make sure you will not be intruding on any wildlife, and you can recover the vehicle if necessary. The key to a safe crossing is the water depth, current and bottom conditions. On soft bottoms, the vehicle will sink in, effectively increasing the water level on the vehicle. Be sure to consider this when determining the depth and the ability to safely cross.

**CROSSING PUDDLES, POOLS, FLOODED AREAS OR OTHER STANDING WATER**

Puddles, pools, flooded or other standing water areas normally contain murky or muddy waters. These water types normally contain hidden obstacles and make it difficult to determine an accurate water depth, approach angle, and bottom condition. Murky or muddy water holes are where you want to hook up tow straps prior to entering. This makes for a faster, cleaner and easier vehicle recovery. If you are able to determine you can safely cross, than proceed using the low and slow method.

**CAUTION!**

Muddy waters can reduce the cooling system effectiveness by depositing debris onto the radiator.

### CROSSING DITCHES, STREAMS, SHALLOW RIVERS OR OTHER FLOWING WATER

Flowing water can be extremely dangerous. Never attempt to cross a fast running stream or river even in shallow water. Fast moving water can easily push your vehicle downstream, sweeping it out of control. Even in very shallow water, a high current can still wash the dirt out from around your tires putting you and your vehicle in jeopardy. There is still a high risk of personal injury and vehicle damage with slower water currents in depths greater than the vehicle's running ground clearance. You should never attempt to cross flowing water which is deeper than the vehicle's running ground clearance. Even the slowest current can push the heaviest vehicle downstream and out of control if the water is deep enough to push on the large surface area of the vehicle's body. Before you proceed, determine the speed of the current, the water's depth, approach angle, bottom condition and if there are any obstacles. Then cross at an angle heading slightly upstream using the low and slow technique.

**WARNING!**

Never drive through fast moving deep water. It can push your vehicle downstream, sweeping it out of control. This could put you and your passengers at risk of injury or drowning.

### After Driving Off-Road

Off-road operation puts more stress on your vehicle than does most on-road driving. After going off-road, it is always a good idea to check for damage. That way you can get any problems taken care of right away and have your vehicle ready when you need it.

- Completely inspect the underbody of your vehicle. Check tires, body structure, steering, suspension, and exhaust system for damage.
- Inspect the radiator for mud and debris and clean as required.
- Check threaded fasteners for looseness, particularly on the chassis, drivetrain components, steering, and suspension. Retighten them, if required, and torque to the values specified in the Service Manual.
- Check for accumulations of plants or brush. These things could be a fire hazard. They might hide damage to fuel lines, brake hoses, axle pinion seals, and propeller shafts.

- After extended operation in mud, sand, water, or similar dirty conditions, have the radiator, fan, brake rotors, wheels, brake linings, and axle yokes inspected and cleaned as soon as possible.

**NOTE:**

Inspect the clutch vent holes in the manual transmission bell housing for mud and debris and clean as required.

**WARNING!**

Abrasive material in any part of the brakes may cause excessive wear or unpredictable braking. You might not have full braking power when you need it to prevent a collision. If you have been operating your vehicle in dirty conditions, get your brakes checked and cleaned as necessary.

- If you experience unusual vibration after driving in mud, slush or similar conditions, check the wheels for impacted material. Impacted material can cause a wheel imbalance and freeing the wheels of it will correct the situation.



# MULTIMEDIA

## UCONNECT SYSTEMS

For detailed information about your Uconnect 4/4C/4C NAV With 8.4-inch Display system, refer to your Uconnect Owner's Manual Supplement.

### NOTE:

Uconnect screen images are for illustration purposes only and may not reflect exact software for your vehicle.

## CYBERSECURITY

Your vehicle may be a connected vehicle and may be equipped with both wired and wireless networks. These networks allow your vehicle to send and receive information. This information allows systems and features in your vehicle to function properly.

Your vehicle may be equipped with certain security features to reduce the risk of unauthorized and unlawful access to vehicle systems and wireless communications. Vehicle software technology continues to evolve over time and FCA US LLC, working with its suppliers, evaluates and takes appropriate steps as needed.

The risk of unauthorized and unlawful access to your vehicle systems may still exist, even if the most recent version of vehicle software (such as Uconnect software) is installed.

### WARNING!

- ONLY insert trusted devices/components into your vehicle. Media of unknown origin could possibly contain malicious software, and if installed in your vehicle, it may increase the possibility for vehicle systems to be breached.
- As always, if you experience unusual vehicle behavior, take your vehicle to an authorized dealer immediately.

### NOTE:

- To help further improve vehicle security and minimize the potential risk of a security breach, vehicle owners should:
  - Routinely check [www.driveuconnect.com](http://www.driveuconnect.com) (US Residents) or [www.driveuconnect.ca](http://www.driveuconnect.ca) (Canadian Residents) to learn about available Uconnect software updates.
  - Only connect and use trusted media devices (e.g. personal mobile phones, USBs, CDs).

## UCONNECT SETTINGS

The Uconnect system uses a combination of buttons on the touchscreen and buttons on the faceplate located on the center of the instrument panel. These buttons allow you to access and change the Customer Programmable Features. Many features can vary by vehicle.

Buttons on the faceplate are located below and/or beside the Uconnect system in the center of the instrument panel. In addition, there is a SCROLL/ENTER control knob located on the right side. Turn the control knob to scroll through menus and change settings. Push the center of the control knob one or more times to select or change a setting.

Your Uconnect system may also have SCREEN OFF and MUTE buttons on the faceplate.

Push the SCREEN OFF button on the faceplate to turn off the Uconnect screen. Push the button again or tap the screen to turn the screen on.

Press the Back Arrow button to exit out of a Menu or certain option on the Uconnect system.

## CUSTOMER PROGRAMMABLE FEATURES

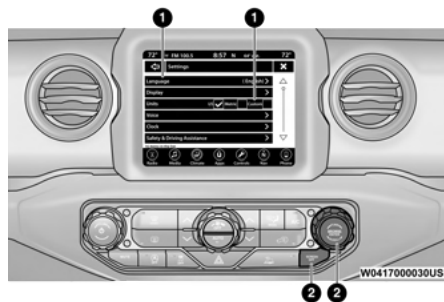

### Uconnect 4C/4C NAV Touchscreen And Faceplate Buttons

1 – Uconnect Buttons On The Touchscreen

2 – Uconnect Buttons On The Faceplate

### For the Uconnect 4 With 7-inch Display and the Uconnect 4/4C/4C NAV With 8.4-inch Display

Press the **ⓘ** Apps button, then press the Settings button on the touchscreen to display the menu setting screen. In this mode the Uconnect system allows you to access programmable features.

#### NOTE:

- Depending on the vehicle's options, feature settings may vary.
- All settings should be changed with the ignition in the ON/RUN position.

When making a selection, only press one button at a time to enter the desired menu. Once in the desired menu, press and release the preferred setting option until a check mark appears next to the setting, showing that setting has been selected. Once the setting is complete, press the X button on the touchscreen to close out of the settings screen. Pressing the Up or Down Arrow button on the right side of the screen will allow you to toggle up or down through the available settings.

## Language

When the Language button is pressed on the touchscreen, the system displays the different language options. Once an option is selected, the system will display in the chosen language. The available setting is:

### NOTE:

Depending on the vehicle's options, feature settings may vary.

Setting Name	Description
Language	This setting will change the language of the Uconnect system and Instrument Cluster Display. The available languages are English, Français, and Español.

## Display

When the Display button is pressed on the touchscreen, the system will display the options related to the theme (if equipped), brightness, and color of the touchscreen. The available settings are:

### NOTE:

Depending on the vehicle's options, feature settings may vary.

Setting Name	Description
Display Mode	This setting will allow you to set the brightness manually or have the system set it automatically. The "Auto" setting has the system automatically adjust the display brightness. The "Manual" setting will allow the user to adjust the brightness of the display.
Display Brightness With Headlights ON/Brightness	This setting will allow you to set the brightness when the headlights are on. To access this setting, Display Mode must be set to Manual. The "+" setting will increase the brightness; the "-" will decrease the brightness.
Display Brightness With Headlights OFF/Brightness	This setting will allow you to set the brightness when the headlights are off. To access this setting, Display Mode must be set to Manual. The "+" setting will increase the brightness; the "-" will decrease the brightness.

Setting Name	Description
<b>Set Theme</b>	This setting will allow you to change the display theme.
<b>Touchscreen Beep</b>	This setting will allow you to turn the touchscreen beep on or off.
<b>Control Screen Timeout</b>	This setting allows you to set the Control Screen to turn off automatically after five seconds or stay open until manually closed.
<b>Navigation Turn-by-Turn Displayed in Cluster</b>	This setting will display navigation prompts in the Instrument Cluster Display.
<b>Phone Pop-ups Displayed in Cluster</b>	This setting will display smartphone notifications and messages in the Instrument Cluster Display.
<b>SiriusXM® Travel Link Weather Alerts</b>	This setting will turn the weather alerts on or off.

## Units

When the Units button is pressed on the touchscreen, the system displays the different measurement options. The selected unit of measurement will display in the instrument cluster display and Navigation system (if equipped). The available settings are:

### NOTE:

Depending on the vehicle's options, feature settings may vary.

Setting Name	Description
<b>US</b>	This setting will change the unit of measurement on the display to US.
<b>Metric</b>	This setting will change the unit of measurement on the display to Metric.
<b>Custom</b>	This setting changes the "Speed" (MPH or km/h), "Distance" (mi or km), "Fuel Consumption" (MPG [US], MPG [UK], L/100 km, or km/L), "Pressure" (psi, kPa, or bar), "Temperature" (°C or °F), and "Torque" (Nm or lb-ft) units of measurement independently.

## Voice

When the Voice button is pressed on the touchscreen, the system displays the options related to the vehicle's Voice Recognition feature.

### NOTE:

Depending on the vehicle's options, feature settings may vary.

Setting Name	Description
Voice Response Length	This setting will change the response length for the Voice Recognition system. The "Brief" setting provides a shortened audio description from the system. The "Detailed" setting provides the full audio description from the system.
Show Command List	This setting will allow you to turn the Command List on or off. The "Always" setting will always show the Command List. The "With Help" setting will show the Command List and provide a brief description of what the command does. The "Never" setting will turn the Command List off.

5

## Clock

When the Clock button is pressed on the touchscreen, the system displays the different options related to the vehicle's internal clock.

### NOTE:

Depending on the vehicle's options, feature settings may vary.

Setting Name	Description
Sync Time With GPS	This setting will sync the time to the GPS receiver in the system. The system will control the time via the GPS location.
Set Time Hours	This setting will allow you to set the hours. Sync Time With GPS must be off for this setting to be available. The "+" setting will increase the hours. The "-" setting will decrease the hours.

Setting Name	Description
Set Time Minutes	This setting will allow you to set the minutes. Sync Time With GPS must be off for this setting to be available. The "+" setting will increase the minutes. The "-" setting will decrease the minutes.
Set Time And Format/Time Format	This setting will allow you to set the time format (AM/PM). Sync Time With GPS must be off for this setting to be available. The "12 hrs" setting will set the time to a 12-hour format. The "24 hrs" setting will set the time to a 24-hour format.
Show Time in Status Bar/Show Time Status	This setting will place the time in the radio's status bar.

## Camera

When the Camera button is pressed on the touchscreen, the system displays the options related to the vehicle's camera features.

### NOTE:

Depending on the vehicle's options, feature settings may vary.

Setting Name	Description
ParkView Backup Camera Delay	This setting will add a timed delay to the ParkView Backup Camera when shifting out of REVERSE.
Active ParkView Backup Camera Guidelines	This setting will turn the Active ParkView Backup Camera Guidelines on or off.
Fixed ParkView Backup Camera Guidelines	This setting will turn the Fixed ParkView Backup Camera Guidelines on or off.
Forward Facing Camera Guidelines	This setting will turn the Forward Facing Camera Guidelines on or off.

## Safety & Driving Assistance

When the Safety & Driving Assistance button is selected on the touchscreen, the system displays the options related to the vehicle's safety settings. These options will differ depending on the features equipped on the vehicle. The settings may display in list form or within subfolders on the screen. To access a subfolder, select the desired folder; the available options related to that feature will then display on the screen.

### NOTE:

Depending on the vehicle's options, feature settings may vary.

Setting Name	Description
<b>Forward Collision Warning Sensitivity — Located In Automatic Emergency Braking Submenu</b>	This setting will change the distance at which the Forward Collision Warning (FCW) alert sounds. The "Medium" setting will have the FCW system signal when an object is in view, and the possibility of a collision is detected. The "Near" setting will have the FCW system signal when the object is closer to the vehicle. The "Far" setting will have the FCW system signal when an object is at a far distance from the vehicle.
<b>Forward Collision Warning — Located In Automatic Emergency Braking Submenu</b>	This setting will turn the Forward Collision Warning (FCW) system on or off. The "Off" setting will deactivate the FCW system. The "Warning Only" setting will provide only an audible chime when a collision is detected. The "Warning + Active Braking" setting will provide an audible chime and apply some brake pressure when a collision is detected.
<b>ParkSense</b>	This setting will change the type of ParkSense alert when a close object is detected and provide both an audible chime and a visual display.
<b>Front ParkSense Volume</b>	This setting adjusts the volume of the Front ParkSense system. The available settings are "Low", "Medium", and "High".
<b>Rear ParkSense Volume</b>	This setting adjusts the volume of the Rear ParkSense system. The available settings are "Low", "Medium", and "High".

Setting Name	Description
Blind Spot Alert	This setting will change the type of alert provided when an object is detected in a vehicle's blind spot. The "Off" setting will turn off Blind Spot Alert. The "Lights" setting will activate the Blind Spot Alert lights on the outside mirrors. The "Lights & Chime" setting will activate both the lights on the outside mirrors and an audible chime.
Hill Start Assist	This setting will turn the Hill Start Assist system on or off.
ParkView Backup Camera Delay	This setting will add a timed delay to the ParkView Backup Camera when shifting out of REVERSE.
Active ParkView Backup Camera Guide Lines	This setting will turn the Active ParkView Backup Camera Guide Lines on or off.
Fixed ParkView Backup Camera Guide Lines	This setting will turn the Fixed ParkView Backup Camera Guide Lines on or off.
Forward Facing Camera Guidelines	This setting will turn the Forward Facing Camera Guidelines on or off.
Tire Fill Assist	This setting will turn the Tire Fill Assist on or off.

## Mirrors & Wipers

When the Mirrors & Wipers button is pressed on the touchscreen, the system displays the option related to the vehicle's mirrors and wipers.

### NOTE:

Depending on the vehicle's options, feature settings may vary.

Setting Name	Description
Headlights With Wipers	This setting will turn the headlights on when the wipers are activated.



## Lights

When the Lights button is pressed on the touchscreen, the system displays the options related to the vehicle's exterior and interior lights.

### NOTE:

- When the "Daytime Running Lights" feature is selected, the daytime running lights can be turned on or off. This feature is only allowed by law in the country of the vehicle purchased.
- Depending on the vehicle's options, feature settings may vary.

Setting Name	Description
Headlight Off Delay	This setting will allow you to set the amount of time it takes for the headlights to shut off after the vehicle is turned off. The available settings are "0 sec", "30 sec", "60 sec", and "90 sec".
Headlight Illumination On Approach/Illuminated Approach	This setting will allow you to set the amount of time it takes for the headlights to shut off after the vehicle is unlocked. The available settings are "0 sec", "30 sec", "60 sec", and "90 sec".
Headlights With Wipers	This setting will turn the headlights on when the wipers are activated.
Auto Dim High Beams/Automatic High Beam Headlamps	This setting will allow you to turn the Auto Dim High Beams on or off.
Daytime Running Lights	This setting will allow you to turn the Daytime Running Lights on or off.
Flash Lights With Lock	This setting will allow you to turn the flashing of the lights when the Lock button is pushed on the key fob on or off.
Interior Ambient Lights	This setting will allow you to turn the Interior Ambient Lights on or off.

## Doors & Locks

When the Doors & Locks button is pressed on the touchscreen, the system displays the options related to locking and unlocking the vehicle's doors.

### NOTE:

Depending on the vehicle's options, feature settings may vary.

Setting Name	Description
<b>Auto Door Locks</b>	This setting will allow you to change if the doors lock automatically when the vehicle reaches 12 mph (19 km/h).
<b>Auto Unlock On Exit</b>	This setting will unlock the doors when any of the doors are opened from the inside.
<b>Flash Lights With Lock</b>	This setting will allow you to turn the flashing of the lights when the Lock button is pushed on the key fob on or off.
<b>Sound Horn With Lock/Horn With Lock</b>	This setting will sound the horn when the Lock button is pushed on the key fob. The "Off" setting will not sound the horn when the Lock button is pushed. The "1st Press" setting will sound the horn when the Lock button is pushed once. The "2nd Press" setting will sound the horn when the Lock button is pushed twice.
<b>Sound Horn With Remote Start/Horn With Remote Start</b>	This setting will sound the horn when the remote start is activated from the key fob.
<b>Remote Door Unlock, Door Lock/1st Press Of Key Fob Unlocks</b>	This setting will change how many pushes of the Unlock button on the key fob are needed to unlock all the doors. The "Driver Door" setting will only unlock the driver door on the first push on the Unlock button. The "All Doors" setting will unlock all doors with only one push of the Unlock button.
<b>Passive Entry</b>	This setting will allow you to turn the Passive Entry feature (Keyless Enter 'n Go™) on or off.

## Seats & Comfort/Auto-On Comfort Systems

When Seats & Comfort/Auto-On Comfort Systems button is pressed on the touchscreen, the system displays the option related to the vehicle's comfort systems when remote start has been activated or the vehicle has been started.

### NOTE:

Depending on the vehicle's options, feature settings may vary.

Setting Name	Description
Auto-On Heated Seat & Steering Wheel	This setting will activate the vehicle's comfort system and heated seats or heated steering wheel when the vehicle is remote started or ignition is started. The "Off" setting will not activate the comfort systems. The "Remote Start" setting will only activate the comfort systems when using Remote Start. The "All Start" setting will activate the comfort systems whenever the vehicle is started.

5

## AUX Switches

When the AUX Switches button is pressed on the touchscreen, the system displays the options related to the four vehicle AUX switches.

### NOTE:

Depending on the vehicle's options, feature settings may vary.

Setting Name	Description
AUX 1-4	This setting will adjust the type and power source for the four vehicle AUX switches. There are two types: "Latching" and "Momentary". The power source for the AUX switches can either be set to run off the "Battery" or from the "Ignition". In addition to setting the type and power source, you can set if the vehicle will recall the previous state at which the AUX switches were set. The Recalled Last State setting can be set to "On" or "Off". Last state conditions are met only if the type is set to Latching and the power source is set to Ignition.

## Key Off Options/Engine Off Options

After pressing the Key Off Options/Engine Off Options button on the touchscreen, the following settings will be available:

### NOTE:

Depending on the vehicle's options, feature settings may vary.

Setting Name	Description
<b>Doors On Key Off Power Delay/Doors On Power Delay</b>	This setting will keep certain electrical features running after the engine is turned on. When any door is opened, the electronics will deactivate. The available settings are "0 sec", "45 sec", "5 min", and "10 min".
<b>Doors Off Key Off Power Delay/Doors Off Power Delay</b>	This setting will keep certain electrical features running after the engine is turned off. When any door is opened, the electronics will deactivate. The available settings are "0 sec", "45 sec", "5 min", and "10 min".
<b>Headlight Off Delay</b>	This setting will allow you to set the amount of time the headlights remain on after the vehicle has been turned off. The "+" will increase the amount of time. The "-" will decrease the amount of time.

## Audio

When the Audio button is pressed on the touchscreen, the system displays options related to the vehicle's sound system. These settings can change the audio location within the vehicle, adjust the bass or treble levels, and auto-play settings from an audio device or smartphone.

### NOTE:

Depending on the vehicle's options, feature settings may vary.

Setting Name	Description
<b>Balance/Fade</b>	This setting will adjust audio levels from specific speakers in the front/back and left/right of the vehicle. The Speaker icon can be moved to set audio location.
<b>Equalizer</b>	This setting will adjust the "Bass", "Mid", and "Treble" ranges of the audio.

Setting Name	Description
Speed Adjusted Volume	This setting will adjust audio volume as speeds increase. At a higher setting, the volume will increase more as the vehicle speeds up. The available settings are "Off", "1", "2", and "3".
AUX Volume Offset	This setting will tune the audio levels from a device connected through the AUX port. The available settings are "+" and "-".
Auto Play	This setting will automatically begin playing audio from a connected device.
Surround Sound	This setting will turn the Surround Sound system on or off.
Loudness	This setting will improve sound quality at lower volumes when enabled.

## Phone/Bluetooth®

When the Phone/Bluetooth® button is pressed on the touchscreen, the system displays the options related to Bluetooth® connectivity from an external audio device or smartphone. The list of paired audio devices or smartphones can be accessed from this menu.

### NOTE:

Depending on the vehicle's options, feature settings may vary.

Setting Name	Description
Phone Pop-ups Displayed In Cluster	This setting will activate phone message pop-ups in the Instrument Cluster Display.
Do Not Disturb	This setting will open the "Do Not Disturb" settings menu. The settings are "Auto Reply" (both, text, call), "Auto Reply Message" (custom, default), and "Custom Auto Reply Message" (create message).
Paired Phones And Audio Devices	This setting will show the list of paired phones and audio devices.
Paired Phones	This setting will show the list of paired phones.

Setting Name	Description
Paired Audio Sources	This setting will show the list of paired audio sources.
Projection Manager	This setting will activate your smartphone to be projected on the vehicle's touchscreen.

### SiriusXM® Setup

When the SiriusXM® Setup button is pressed on the touchscreen, the system displays options related to SiriusXM® satellite radio. These settings can be used to skip specific radio channels and restart favorite songs from the beginning.

#### NOTE:

- A subscription to SiriusXM® satellite radio is required for these settings to be functional.
- Depending on the vehicle's options, feature settings may vary.

Setting Name	Description
Tune Start	This setting will play the current song from the beginning when you tune to a music channel using one of the 12 presets.
Channel Skip	This setting allows you to set channels that you wish to skip. A channel list will display of the skipped channels.
Subscription Info	This menu provides SiriusXM® subscription information. SiriusXM® Travel Link is a separate subscription.

## Reset/Restore Settings

When the Reset/Restore Settings button is pressed on the touchscreen, the system displays the options related to resetting the Uconnect system back to its default settings. These settings can clear personal data and reset selected settings from other menus.

### NOTE:

Depending on the vehicle's options, feature settings may vary.

Setting Name	Description
<b>Reset App Drawer To Default Order</b>	This setting will reset the app drawer to its factory default layout.
<b>Restore Apps</b>	This setting will restore all installed apps. This feature is used if there is an issue using or installing apps.
<b>Restore Settings to Default</b>	This setting will return all the previously changed settings to their factory default.
<b>Clear Personal Data</b>	This setting will display a pop-up that gives you the option to clear all personal data from the system, including Bluetooth® devices and presets.

5

## System Information

When the System Information button is pressed on the touchscreen, the system displays the radio system information.

### NOTE:

Depending on the vehicle's options, feature settings may vary.

Setting Name	Description
<b>Software Licenses</b>	This setting will display the software licensing information screen.
<b>Map Update</b>	This setting will display different ways to update maps of the radio into your system. "Download System Information To USB" and "Generate Request Code" will appear as the two options to select from.

## UCONNECT INTRODUCTION

### SYSTEM OVERVIEW



**Uconnect 3 With 5-inch Display**

- 1 – RADIO Button
- 2 – MEDIA Button
- 3 – PHONE Button
- 4 – VOLUME & On/Off Button
- 5 – MUTE Button

- 6 – COMPASS Button
- 7 – SETTINGS Button
- 8 – MORE Button
- 9 – ENTER/BROWSE & TUNE/SCROLL Knob
- 10 – SCREEN OFF Button



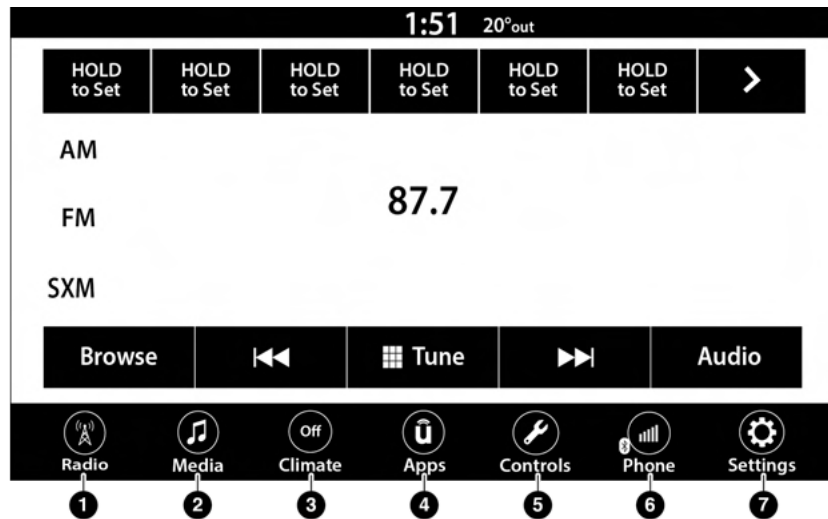

5





#### Uconnect 4 With 7-inch Display

- 1 – Radio Button
- 2 – Media Button
- 3 – Climate Button
- 4 – Apps Button

- 5 – Controls Button
- 6 – Phone Button
- 7 – Settings Button

#### NOTE:

Uconnect screen images are for illustration purposes only and may not reflect exact software for your vehicle.

Feature	Description
Radio/Media	Press/Push the Radio button or Media button to enter Radio Mode/Media Mode and access the radio functions and external audio sources ↪ page 226.
Phone	Press/Push the Phone button to enter Phone Mode and access the hands-free phone system ↪ page 239.
Settings	Press/Push the Settings button to access the Uconnect Settings ↪ page 207.
	Push the ENTER/BROWSE button on the faceplate to accept a highlighted selection on the screen. Rotate the TUNE/SCROLL rotary knob to scroll through a list or tune a radio station.
	Push the SCREEN OFF button on the faceplate to turn the screen on or off.
	Push the MUTE button on the faceplate to turn the audio of the radio system off. Push it again to turn the audio back on.
	Rotate the rotary knob to adjust the volume. Push the VOLUME & On/Off button on the faceplate to turn the system on or off.  <b>NOTE:</b> Push and hold the VOLUME & On/Off button for approximately 10 seconds to reset the radio manually. Doing this can also recover the radio screen from freezing or being stuck.
Compass	Press/Push the COMPASS button on the faceplate to access the vehicle's compass.
More	Press/Push the MORE button on the faceplate to access additional options.

Feature	Description
Controls – If Equipped	Press the Controls button to access vehicle-specific features like heated seats and steering wheel.
Apps	Press the Apps button to access a list of the available Mobile apps.
Climate	Press the Climate button to enter Climate Mode and access the climate control functions → page 62.

## DRAG & DROP MENU BAR

The Uconnect features and services in the main menu bar are easily customized for your preference. Simply follow these steps:



### Uconnect 4 With 7-inch Display Drag & Drop

1. Press the Apps  button to open the App screen.

2. Press and hold, then drag the selected app to replace an existing shortcut in the main menu bar.

#### NOTE:

This feature is only available if the vehicle is in PARK.

## SAFETY AND GENERAL INFORMATION

### Safety Guidelines

#### WARNING!

ALWAYS drive safely with your hands on the steering wheel. You have full responsibility and assume all risks related to the use of the Uconnect features and applications in this vehicle. Only use Uconnect when it is safe to do so. Failure to do so may result in an accident involving serious injury or death.

Please read this manual carefully before using the system. It contains instructions on how to use the system in a safe and effective manner.

**Do NOT attach any object to the touchscreen. Doing so can result in damage to the touchscreen.**

5

Please read and follow these safety precautions. Failure to do so may result in injury or property damage.

- Glance at the screen only when safe to do so. If prolonged viewing of the screen is required, park in a safe location and set the parking brake.
- Stop use immediately if a problem occurs. Failure to do so may cause injury or damage to the product. See an authorized dealer for repair.
- Ensure the volume level of the system is set to a level that still allows you to hear outside traffic and emergency vehicles.

## Safe Usage Of The Uconnect System

- The Uconnect system is a sophisticated electronic device. Do not let young children use the system.
- Permanent hearing loss may occur if you play your music or sound system at loud volumes. Exercise caution when setting the volume on the system.
- Keep drinks, rain and other sources of moisture away from the system. Besides damage to the system, moisture can cause electric shocks as with any electronic device.

### NOTE:

Many features of this system are speed dependent. For your own safety, it is not possible to use some of the touchscreen features while the vehicle is in motion.

## Care And Maintenance

- Do not press the touchscreen with any hard or sharp objects (pen, USB stick, jewelry, etc.), which could scratch the surface.
- Do not spray any liquid or chemicals directly on the screen! Use a clean and dry microfiber lens cleaning cloth in order to clean the touchscreen.
- If necessary, use a lint-free cloth dampened with a cleaning solution, such as isopropyl alcohol or an isopropyl alcohol and water solu-

tion ratio of 50:50. Be sure to follow the solvent manufacturer's precautions and directions → page 431.

## UCONNECT MODES

### STEERING WHEEL AUDIO CONTROLS

The remote sound system controls are located on the rear surface of the steering wheel at the three and nine o'clock positions.

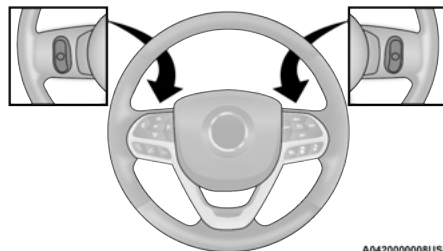

Remote Sound System Controls

The right-hand control is a rocker-type switch with a push button in the center and controls the volume and mode of the sound system. Pushing the top of the rocker switch will increase the volume, and pushing the bottom of the rocker switch will decrease the volume.

Pushing the center button will make the radio switch between the various modes available (AM/FM/SXM or Media, etc.).

The left-hand control is a rocker-type switch with a push button in the center. The function of the left-hand control is different depending on which mode you are in.

The following describes the left-hand control operation in each mode:

### Radio Operation

Pushing the top of the switch will Seek Up for the next available station and pushing the bottom of the switch will Seek Down for the next available station.

The button located in the center of the left-hand control will tune to the next preset station that you have programmed in the radio presets.

### Media Mode

Pushing the top of the switch skips to the next track on the selected media (AUX/USB/Bluetooth®). Pushing the switch up twice will go forward two tracks. Pushing the bottom switch goes to the beginning of the current track, or the beginning of the previous track if it is within eight seconds after the current track begins to play. Double pressing the bottom button switch will skip to the previous track if it is after eight seconds into the current track.

## RADIO MODE

### Radio Controls

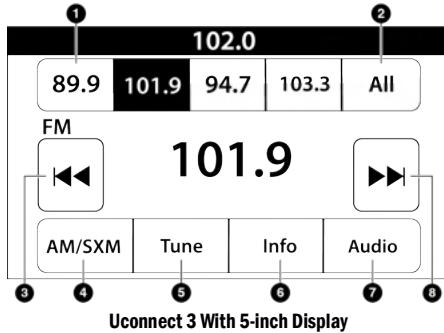

- 1 – Preset Radio Stations
- 2 – All Preset Radio Stations
- 3 – Seek Down ◀◀
- 4 – Radio Band (AM/FM)
- 5 – Tune
- 6 – Station Info
- 7 – Audio Settings
- 8 – Seek Up ▶▶

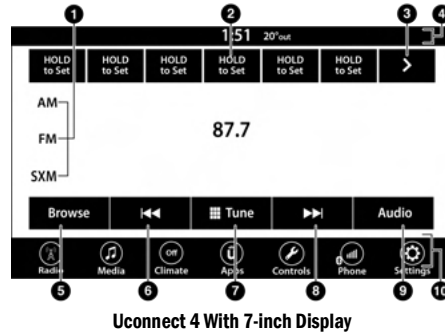

- 1 – Radio Bands
- 2 – Preset Radio Stations
- 3 – View Next Preset Radio Stations
- 4 – Status Bar
- 5 – Browse Button
- 6 – Seek Down ◀◀
- 7 – Tune Button
- 8 – Seek Up ▶▶
- 9 – Audio Settings
- 10 – Bottom Menu Bar

The radio is equipped with the following modes:

- AM
- FM
- SiriusXM® Satellite Radio (if equipped)

Press the Radio button on the touchscreen to enter the Radio Mode. The different tuner modes, AM, FM, and SXM, can then be selected by pressing the corresponding button in Radio Mode.

### Volume & On/Off Control

Push the VOLUME & On/Off control knob to turn on and off the Uconnect system.

The electronic volume control turns continuously (360 degrees) in either direction, without stopping. Turning the VOLUME & On/Off control knob clockwise increases the volume, and counterclockwise decreases it.

When the audio system is turned on, the sound will be set at the same volume level as last played.

### Mute Button

Push the MUTE button to mute or unmute the system.

### Tune/Scroll Control

Turn the rotary TUNE/SCROLL control knob clockwise to increase or counterclockwise to decrease the radio station frequency. Push the ENTER/BROWSE button to choose a selection.

## Seek

The Seek Up and Down functions are activated by pressing the double arrow buttons on the touchscreen to the right and left of the radio station display or by pushing the left steering wheel audio control button up or down.

### Seek Up ►► and Seek Down ◀◀

Press and release the Seek Up ►► or Seek Down ◀◀ button to tune the radio to the next available station or channel. During a Seek Up/Down function, if the radio reaches the starting station after passing through the entire band two times, the radio will stop at the station where it began.

### Fast Seek Up ►► and Fast Seek Down ◀◀

Press and hold, and then release the Seek Up ►► or Seek Down ◀◀ button to advance the radio through the available stations or channels at a faster rate. The radio stops at the next available station or channel when the button on the touchscreen is released.

## NOTE:

Pressing and holding either the Seek Up ►► or Seek Down ◀◀ button will scan the different frequency bands at a slower rate.

## Info — If Equipped

Press the Info button to display information related to the currently playing song and radio station.

## Direct Tune

Press the Tune button located at the bottom of the radio screen to directly tune to a desired radio station or channel.

Press the available number button on the touchscreen to begin selecting a desired station. Once a number has been entered, any numbers that are no longer possible (stations that cannot be reached) will become deactivated/grayed out.

## Undo

You can backspace an entry by pressing the Back <⌫> button on the touchscreen.

## GO

Once the last digit of a station has been entered, press “OK”. The Direct Tune screen will close, and the system will automatically tune to that station.

## RADIO VOICE COMMANDS

Use your voice to quickly get to the AM, FM, or SiriusXM® Satellite Radio stations you would like to hear. (Subscription or included SiriusXM® Satellite Radio trial required.)

Push the VR button (Ⓜ) on the steering wheel and wait for the beep to say a command. See an example:

- “Tune to ninety-five-point-five FM”
- “Tune to Satellite Channel Hits 1”

**Did You Know:** At any time, if you are not sure of what to say or want to learn a Voice Command, push the VR button (Ⓜ) and say “Help”. The system provides you with a list of commands.

## SiriusXM® Satellite Radio Mode — If Equipped

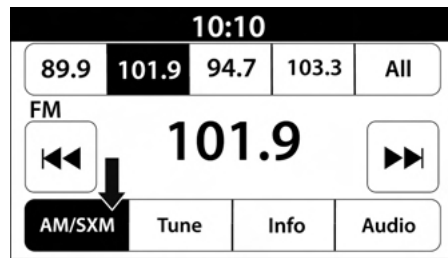

Uconnect 3 With 5-inch Display Changing To SiriusXM®



Uconnect 4 With 7-inch Display Changing To SiriusXM®

SiriusXM® Satellite Radio uses direct satellite-to-receiver broadcasting technology to provide clear, coast-to-coast radio content. SiriusXM® is a subscription-based service.

Visit [siriusxm.com/getallaccess](http://siriusxm.com/getallaccess) or review your SiriusXM® Radio pamphlet in your Owner's Manual kit for more information.

SiriusXM® services require subscriptions, sold separately after the trial included with the new vehicle purchase. If you decide to continue your service at the end of your trial subscription, the plan you choose will automatically renew and bill at then-current rates until you call SiriusXM® at 866-635-2349 to cancel. See SiriusXM® Customer Agreement for complete terms at [www.siriusxm.com](http://www.siriusxm.com) (US) or [www.siriusxm.ca](http://www.siriusxm.ca) (Canada).

All fees and programming subject to change. SiriusXM® satellite service is available only to those at least 18 and older in the 48 contiguous US and D.C. Our SiriusXM® satellite service is also available in Canada and Puerto Rico (with coverage limitations). SiriusXM® Internet radio service is available throughout their satellite service area and in AK. © 2021 SiriusXM® Radio Inc. SiriusXM® and all related marks and logos are trademarks of SiriusXM® Radio Inc.

This functionality is only available for radios equipped with a Satellite receiver. In order to receive satellite radio, the vehicle needs to be outside with a clear view to the sky.

If the screen shows "Acquiring Signal", you might have to change the vehicle's position in order to receive a signal. In most cases, the satellite radio does not receive a signal in underground parking garages or tunnels.

#### No Subscription

Radios equipped with a Satellite receiver require a subscription to the SiriusXM® Service. When the radio does not have the necessary subscription, the radio is able to receive the Preview channel only.

#### Acquiring SiriusXM® Subscription

To activate the SiriusXM® Satellite Radio subscription, US residents visit <http://www.siriusxm.com/getallaccess> or call: 1-800-643-2112

Canadian residents visit <https://www.siriusxm.ca/> or call: 1-888-539-7474.

#### NOTE:

You will need to provide the SiriusXM® ID (RID) located at the bottom of the Channel 0 screen. The Satellite Mode is activated by a press of the SXM button on the touchscreen.

When in Satellite Mode:

- The SXM button on the touchscreen is highlighted.
- The SiriusXM® Presets are displayed at the top of the screen.
- The SiriusXM® Channel Number is displayed in the center.
- The Program Information is displayed at the bottom of the Channel Number.
- The SiriusXM® function buttons are displayed below the Program Information.

Tuning is done by operating the Tune Knob or by Direct Tune, similar to other Radio Bands.

In addition to the tuning operation functions common to all radio modes, the Replay, Traffic/Weather button, and Favorite button functions are available in SiriusXM® Mode.

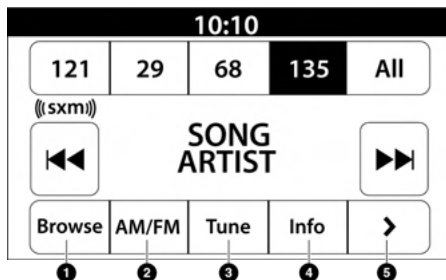

**Uconnect 3 With 5-inch Display SiriusXM® Satellite Radio**

- 1 – Browse
- 2 – Radio Bands
- 3 – Direct Tune
- 4 – Info Button
- 5 – Next Button



**Uconnect 4 With 7-inch Display SiriusXM® Satellite Radio**



- 1 – Browse
- 2 – Replay
- 3 – Seek Down Button ◀◀
- 4 – Direct Tune Button
- 5 – Seek Up Button ▶▶
- 6 – Audio Settings Button

## REPLAY



Replay provides a means to store and replay up to 22 minutes of music audio and 48 minutes of talk radio. Once the channel is switched, content in replay memory is lost.

Press the Replay button on the touchscreen. The Play/Pause, Rewind/Forward and Live buttons will display at the top of the screen, along with the replay time.

You can exit by pressing the Replay button on the touchscreen any time during the Replay Mode.

Play/Pause		Press the Pause/Play button on the touchscreen to pause the playing of live or rewound content at any time. Play can be resumed by pressing the Pause/Play button again on the touchscreen.
Rewind		Press the Rewind button on the touchscreen to rewind the content in steps of five seconds. Pressing the Rewind button on the touchscreen for more than two seconds rewinds the content. The radio begins playing the content at the point at which the press is released.



Forward		Each press of the Forward button on the touchscreen forwards the content in steps of five seconds. Forwarding of the content can only be done when the content is previously rewind, and therefore, cannot be done for live content. A continuous press of the Forward button on the touchscreen also forwards the content. The radio begins playing the content at the point at which the press is released.
Live		Press the Live button on the touchscreen to resume the playing of live content.

## FAVORITES

Press the Favorites button on the touchscreen to activate the favorites menu, which will time out within 20 seconds in absence of user interaction.

You can exit the Favorites Menu by a press of the X button.

The Favorites feature enables you to set a favorite artist or song that is currently playing. The radio then uses this information to alert you when either the favorite artist or song is being played at any time by any of the SiriusXM® Channels.

The maximum number of favorites that can be stored in the Radio is 50.

**Favorite Artist:** While the song is playing, to set a favorite artist, press the Favorites button on the touchscreen and then the Favorite Artist button on the touchscreen.

**Favorite Song:** While the song is playing, to set a favorite song, press the Favorites button on the touchscreen and then the Favorite Song button on the touchscreen.

## BROWSE IN SXM



**Uconnect 4 With 7-inch Display Browse Button**

- 1 — All Button
- 2 — Presets Button
- 3 — Favorites Button
- 4 — Game Zone Button

Press the Browse button on the touchscreen to edit Presets, Favorites, Game Zone, and Jump settings, along with providing the SiriusXM® Channel List.

This Screen contains many submenus. You can exit submenus to return to a parent menu by pressing the Back arrow.

### All

Press the All button on the Browse Screen. When pressing the All button, the following categories become available:

- **Channel List:** Press the Channel List to display all the SiriusXM® Channel Numbers. You can scroll the Channel List by pressing the Up and Down arrows, located on the right side of the screen. Scrolling can also be done by operating the TUNE/SCROLL knob.
- **Genre List:** Press the Genre button on the touchscreen to display a list of Genres. You can select any desired Genre by pressing the Genre List. The radio tunes to a channel with the content in the selected Genre.

### Presets — If Equipped

Press the Presets button (if equipped) located at the left of the Browse screen.

You can scroll the Presets list by pressing the Up and Down arrows located at the right side of the screen. Scrolling can also be done by operating the TUNE/SCROLL knob as well.

### Preset Selection

A preset can be selected by pressing any of the listed Presets, or by pushing the ENTER/BROWSE button on the TUNE/SCROLL knob to select the currently highlighted Preset. When selected, the Radio tunes to the station stored in the Preset.

### Deleting A Preset

A preset can be deleted in the Presets Browse screen by pressing the Trash Can icon for the corresponding preset.

### Favorites

Press the Favorites button on the Browse screen.

The Favorites menu provides a means to edit the Favorites list and to configure the Alert Settings, along with providing a list of Channels currently airing any of the items in the Favorites list.

You can scroll the Favorites list by pressing the Up and Down arrows located at the right side of the screen. Scrolling can also be done by operating the TUNE/SCROLL knob as well.

### Remove Favorites

Press the Remove Favorites tab at the top of the screen. Press the Delete All button on the touchscreen to delete all of the Favorites or press the Trash Can icon next to the Favorite to be deleted.

### Alert Settings

Press the Alert Settings tab at the top of the Favorites screen. The Alert Settings menu allows you to choose from a visual alert or audible and visual alert when one of your favorites is airing on any of the SiriusXM® channels.

### Game Zone

Press the Game Zone button, located at the left of the Browse screen. This feature provides you with the ability to select teams, edit the selection, and set alerts.

### On-Air

Press the On-Air tab at the top of the screen. The On-Air list provides a list of Channels currently airing any of the items in the Selections list, and pressing any of the items in the list tunes the radio to that channel.

### Select Team Or Add/Delete — If Equipped

Press the Select Team or Add/Delete button on the touchscreen to activate the League Scroll list. Press the chosen league and a scroll list of all teams within the league will appear, then you can select a team by pressing the corresponding box. A check mark appears for all teams that are chosen.

### Remove Selection/Trash Can Icon

Press the Remove Selection tab at the top of the screen. Press the Delete All button on the touchscreen to delete all of the selections or press the Trash Can icon next to the selection to be deleted.

### Alert Settings

Press the Alert Setting tab at the top of the screen. The Alert Settings menu allows you to choose from “Alert me to on-air games upon start” or “Alert upon score update” or both when one or more of your selections is airing on any of the SiriusXM® channels.

### Tune Start

Tune Start begins playing the current song from the beginning when you tune to a music channel using one of the 12 presets. This feature occurs the first time the preset is selected during that current song.

### Setting Presets

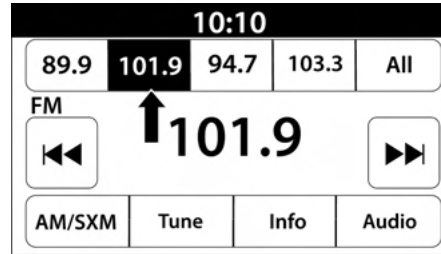

Uconnect 3 With 5-inch Display Radio Presets



Uconnect 4 With 7-inch Display Radio Presets

The Presets are available for all Radio Modes, and are activated by pressing any of the Preset buttons, located at the top of the screen.

When you are on a station that you wish to save as a preset, press and hold the numbered button on the touchscreen for more than two seconds.

The Radio stores up to 12 presets in each of the Radio Modes.

A total of six presets will appear on the screen. You can switch between the radio presets list by pressing the Arrow button located in the upper right of the radio touchscreen.

For the Uconnect 3 With 5-inch Display

A set of four presets will appear on the screen. Press the All button to view all saved presets. To remove a saved preset, a new preset must be saved over the old one.

## PRESET FEATURES — IF EQUIPPED

### Browse In AM/FM

When in either AM or FM, the Browse Screen provides a means to edit the Presets List and is entered by pushing the ENTER/BROWSE button.

### Scrolling Preset List

Once in the Browse Presets screen, you can scroll the preset list by rotation of the TUNE/SCROLL knob or by pressing the Up or Down Arrow key, located on the right of the screen.

### Preset Selection From List

A preset can be selected by pressing any of the listed Presets, or by pushing the ENTER/BROWSE button or the TUNE/SCROLL knob to select the currently highlighted Preset.

When selected, the radio tunes to the station stored in the Presets.

### Deleting Presets

A preset can be deleted in the Presets Browse screen by pressing the Trash Can icon for the corresponding preset.

### Return To Main Radio Screen

You can return to the Main Radio Screen by pressing the X button or the Back Arrow button when in the Browse Presets screen.

### Audio Settings

Press the Audio button within the settings main menu to activate the Audio Settings screen.

The audio settings can also be accessed on the Radio Mode screen by pressing the Audio button. You can return to the Radio screen by pressing the X button.



Uconnect 3 With 5-inch Display



Uconnect 4 With 7-inch Display

Audio Setting	Description
<b>Balance/Fade</b>	Press the Balance/Fade button on the touchscreen to balance audio between the front speakers or fade the audio between the rear and front speakers. Press the Front, Rear, Left or Right button or press and drag the red Speaker icon to adjust the Balance/Fade.
<b>Equalizer</b>	Press the + or – button or press and drag the level bar to increase or decrease each of the equalizer bands. The level value, which spans between plus or minus nine, is displayed at the top of each of the bands.
<b>Speed Adjusted Volume</b>	The Speed Adjusted Volume is adjusted by selecting from “Off”, “1”, “2”, and “3”. This alters the automatic adjustment of the audio volume with variation to vehicle speed. Volume increases automatically as speed increases to compensate for normal road noise.
<b>Surround Sound – If Equipped</b>	When Surround Sound is on, you can hear audio coming from every direction as in a movie theatre or home theatre system.
<b>Loudness – If Equipped</b>	When Loudness is on, the sound quality at lower volumes improves.
<b>AUX Volume Offset</b>	The AUX Volume Offset is adjusted by pressing + and – buttons. This alters the AUX input audio volume. The level value, which spans between plus or minus three, is displayed above the adjustment bar.
<b>Auto Play – If Equipped</b>	The Auto Play feature begins playing music as soon as a USB Media device is connected to one of the vehicle’s Media USB ports, when it is turned on. Press “Off” to turn the setting off.
<b>Radio Off With Door – If Equipped</b>	The Radio Off With Door feature, when activated, keeps the radio on until the driver or passenger door is opened or until the Radio Off Delay selected time has expired.

## MEDIA MODE

### Operating Media Mode

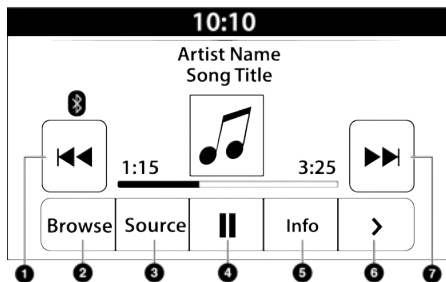

**Uconnect 3 With 5-inch Display Operating Media Mode**

- 1 – Seek Down ◀◀
- 2 – Browse
- 3 – Source
- 4 – Pause/Play
- 5 – Info
- 6 – More Options
- 7 – Seek Up ▶▶

Media Mode is entered by pushing the MEDIA button located on the faceplate.

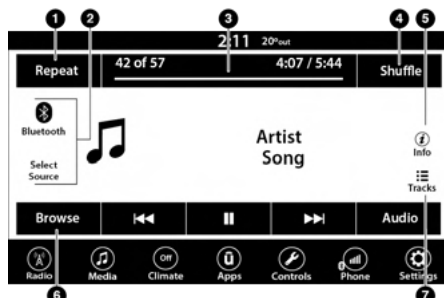

**Uconnect 4 With 7-inch Display Operating Media Mode**

- 1 – Repeat
- 2 – Select Source
- 3 – Track Time
- 4 – Shuffle
- 5 – Info
- 6 – Browse
- 7 – Tracks

### Audio Source Selection

Once in Media Mode, press the Source or Source Select button on the touchscreen and the desired mode button on the touchscreen. USB, AUX, and Bluetooth® are the Media sources available.

When available, you can select the Browse button on the touchscreen to be given these options:

- Now Playing
- Artists
- Albums
- Genres
- Songs
- Playlists
- Folders

You can press the Source, Pause/Play, or the Info button on the touchscreen for artist information on the current song playing.

For the Uconnect 3 With 5-inch Display, Media Mode is entered by pushing the MEDIA button located on the faceplate.

## Types of Media Modes

### USB MODE

#### Overview

USB Mode is entered by inserting a USB device into the USB port, by selecting the USB button on the left side of the touchscreen, or by selecting the Source Select/Select Source button and then selecting USB 1 or 2 (if equipped) or by pushing the MEDIA button on the faceplate and then selecting the USB button.

On the Uconnect 3 With 5-inch Display, if you insert a USB device with the ignition in ON/RUN, the unit will switch to USB Mode and begin to play. The display will show the track number and index time in minutes and seconds. Play will begin at the start of track 1.

## BLUETOOTH® MODE

### Overview

Bluetooth® Streaming Audio or Bluetooth® Mode is entered by pairing a Bluetooth® device, containing music, to the Uconnect system.

Before proceeding, the Bluetooth® device must be paired to the Uconnect Phone to communicate with the Uconnect system.

On the Uconnect 3 With 5-inch Display, push the MEDIA button located on the faceplate. Once in Media Mode, press the Source button on the touchscreen and select the Bluetooth® button [↷ page 239](#).

To access Bluetooth® Mode, press the Bluetooth® button on the left side of the touchscreen or under the Source Select/Select Source button (if equipped).



Uconnect 4 With 7-inch Display Select Source

## AUX MODE

### Overview

Auxiliary Mode (AUX) is entered by inserting an AUX device using a cable with a 3.5 mm audio jack into the AUX port, or by pressing the AUX button on the left side of the touchscreen, or under the Source Select button (if equipped) or by pushing the MEDIA button on the faceplate, selecting the Source button and then the AUX button.

To insert an Auxiliary device, gently insert the Auxiliary device cable into the AUX port. If you insert an Auxiliary device with the ignition and the radio on, the unit will switch to AUX Mode and begin to play.

## Controlling The Auxiliary Device

The control of the Auxiliary device (e.g., selecting playlists, play, fast forward, etc.) cannot be provided by the radio; use the device controls instead. Adjust the volume with the Volume button, Volume/Mute rotary knob, or the On/Off rotary knob, or with the volume of the attached device.

### NOTE:

The radio unit is acting as the amplifier for audio output from the Auxiliary device. Therefore, if the volume control on the Auxiliary device is set too low, there will be insufficient audio signal for the radio unit to play the music on the device.

### Seek Up **▶▶**/Seek Down **◀◀**

In USB Mode, press the Seek Up button on the touchscreen for the next selection on the USB device. Press and release the Seek Down button on the touchscreen to return to the beginning of the current selection, or to return to the beginning of the previous selection if the USB device is within the first three seconds of the current selection.

In Bluetooth® Mode, press and release the Seek Up button on the touchscreen for the next selection on the Bluetooth® device. Press and release the Seek Down button on the touchscreen to return to the beginning of the current selection, or return to the beginning of the previous selection if the Bluetooth® device is within the first second of the current selection.

## Browse

In USB Mode, press the Browse button on the touchscreen to display the browse window. In USB Mode, the left side of the browse window displays a list of ways you can browse through the contents of the USB device. If supported by the device, you can browse by Folder, Artist, Playlist, Album, Song, etc. Press the desired button on the touchscreen on the left side of the screen. The center of the browse window shows items and their sub-functions, which can be scrolled through by pressing the Up and Down buttons to the right. The TUNE/SCROLL knob can also be used to scroll.

On the Uconnect 3 With 5-inch Display, rotate the BROWSE button on the faceplate or press the Browse button on the touchscreen to scroll through and select a desired track on the device. Press the Exit button on the touchscreen if you wish to cancel the Browse function.

## Media Mode

In USB Mode, press the Media button on the touchscreen to select the desired audio source: USB.

In Bluetooth® Mode, press the Media button on the touchscreen to select the desired audio source: Bluetooth®.

In AUX Mode, press the Media button on the touchscreen to select the desired audio source: AUX.

## Repeat

In USB Mode, press the Repeat button on the touchscreen to toggle the repeat functionality. The Repeat button on the touchscreen is highlighted when active. The Radio will continue to play the current track, repeatedly, as long as the repeat is active. Press the Repeat button again to enter Repeat All. The radio will continue to play all the current tracks, repeatedly, as long as the repeat function is active. To cancel Repeat, press the Repeat button a third time.

## Shuffle

In USB Mode, press the Shuffle button on the touchscreen to play the selections on the USB device in random order to provide an interesting change of pace. Press the Shuffle button on the touchscreen a second time to turn this feature off.

## Audio

Audio settings can be accessed by pressing the Audio button ↗ page 227.

## Info

In USB Mode, press the Info button on the touchscreen to display the current track information. Press the Info or X button on the touchscreen a second time to cancel this feature.

## Tracks

In USB Mode, press the Tracks button on the touchscreen to display a pop-up with the Song List.

The song currently playing is indicated by an arrow and lines above and below the song title. When in the Tracks List screen you can rotate the TUNE/SCROLL knob to highlight a track (indicated by the line above and below the track name) and then push the ENTER/BROWSE knob to start playing that track.

In Bluetooth® Mode, if the Bluetooth® device supports this feature, press the Tracks button on the touchscreen to display a pop-up with the Song List. The currently playing song is indicated by a red arrow and lines above and below the song title.

Pressing the Tracks button on the touchscreen while the pop-up is displayed will close the pop-up.

## MEDIA VOICE COMMANDS

Uconnect offers connections via USB, Bluetooth®, and auxiliary (AUX) ports. Voice operation is only available for connected USB and AUX devices.

Push the VR button  located on the steering wheel. After the beep, say one of the following commands and follow the prompts to switch your media source or choose an artist:

- “Change source to Bluetooth®”
- “Change source to AUX”
- “Change source to USB”
- “Play artist Beethoven”; “Play album Greatest Hits”; “Play song Moonlight Sonata”; “Play genre Classical”



**Did You Know:** Press the Browse button on the touchscreen to see all of the music on your USB device. Your Voice Command must match exactly how the artist, album, song, and genre information is displayed.

## PHONE MODE

### Overview

Uconnect Phone is a voice-activated, hands-free, in-vehicle communications system. It allows you to dial a phone number with your mobile phone.

The feature supports the following:

#### Voice Activated Features

- Hands-Free dialing via Voice (“Call John Smith Mobile” or “Dial 248-555-1212”).
- Hands-Free text-to-speech listening of your incoming SMS messages.
- Hands-Free Text Message Replying: Forward one of 18 predefined SMS messages to incoming calls/text messages.
- Redialing last dialed numbers (“Redial”).
- Calling Back the last incoming call number (“Call Back”).
- Viewing call logs on screen (“Show Incoming Calls,” “Show Outgoing Calls,” “Show Missed Calls,” or “Show Recent Calls”).
- Searching Contacts phone number (“Search for John Smith Mobile”).

### Screen Activated Features

- Dialing via Keypad using touchscreen.
- Viewing and Calling contacts from Phonebooks displayed on the touchscreen.
- Setting Favorite Contact phone numbers so they are easily accessible on the Main Phone screen.
- Viewing and Calling contacts from Recent Call logs.
- Reviewing your recent Incoming SMS Messages.
- Pairing up to 10 phones/audio devices for easy access to connect to them quickly.

#### NOTE:

Your phone must be capable of SMS messaging via Bluetooth® for messaging features to work properly.

Your mobile phone’s audio is transmitted through your vehicle’s audio system; the system will automatically mute your radio when using the Uconnect Phone.

For Uconnect customer support:

- US visit [UconnectPhone.com](http://UconnectPhone.com) or call 877-855-8400
- Canada visit [UconnectPhone.com](http://UconnectPhone.com) or call 800-465-2001 (English) or (French) call 800-387-9983

Uconnect Phone allows you to transfer calls between the system and your mobile phone as you enter or exit your vehicle and enables you to mute the system’s microphone for private conversation.

#### WARNING!

ALWAYS drive safely with your hands on the steering wheel. You have full responsibility and assume all risks related to the use of the Uconnect features and applications in this vehicle. Only use Uconnect when it is safe to do so. Failure to do so may result in an accident involving serious injury or death.

The Phone feature is driven through your Bluetooth® “Hands-Free Profile” mobile phone. Uconnect features Bluetooth® technology — the global standard that enables different electronic devices to connect to each other without wires or a docking station. Ensure your phone is turned on with Bluetooth® active and has been paired to the Uconnect system. Up to 10 mobile phones or audio devices are allowed to be linked to the system. Only one linked (or paired) mobile phone and one audio device can be used with the system at a time.

## Phone Button



The Phone button on your steering wheel is used to get into the Phone Mode and make calls, show recent, incoming or outgoing calls, view phonebook, etc.

When you push the button you will hear a BEEP. The BEEP is your signal to give a command.

## Voice Command Button



The Voice Command button on your steering wheel is only used for “barge in” and when you are already in a call or want to make another call.

The button on your steering wheel is also used to access the Voice Commands for the Uconnect Voice Command features if your vehicle is equipped.

## Phone Operation

### OPERATION

Voice commands can be used to operate the Uconnect Phone and to navigate its menu structure. Voice commands are required after most Uconnect Phone prompts. There are two general methods for how Voice Command works:

1. Say compound commands like “Call John Smith mobile”.
2. Say the individual commands and allow the system to guide you to complete the task.

You will be prompted for a specific command and then guided through the available options.

- Prior to giving a voice command, one must wait for the beep, which follows the “Listen” prompt or another prompt.
- For certain operations, compound commands can be used. For example, instead of saying “Call” and then “John Smith” and then “mobile”, the following compound command can be said: “Call John Smith mobile.”
- For each feature explanation in this section, only the compound command form of the voice command is given. You can also break the commands into parts and say each part of the command when you are asked for it. For example, you can use the compound command form voice command “Search for John Smith,” or you can break the compound command form into two voice commands: “Search Contacts” and when asked, “John Smith.” Please remember, the Uconnect Phone works best when you talk in a normal conversational tone, as if speaking to someone sitting a few feet/meters away from you.

### NATURAL SPEECH

Your Uconnect Phone Voice system uses a Natural Language Voice Recognition (VR) engine.

Natural speech allows the user to speak commands in phrases or complete sentences. The system filters out certain non-word utterances and sounds such as “ah” and “eh.” The system handles fill-in words such as “I would like to”.

The system handles multiple inputs in the same phrase or sentence such as “make a phone call” and “to Kelly Smith”. For multiple inputs in the same phrase or sentence, the system identifies the topic or context and provides the associated follow-up prompt such as “Who do you want to call?” in the case where a phone call was requested but the specific name was not recognized.

The system utilizes continuous dialog. When the system requires more information from the user, it will ask a question to which the user can respond without pushing the Voice Command button on the steering wheel.

### HELP COMMAND

If you need assistance at any prompt, or if you want to know your options at any prompt, say “Help” following the beep.

To activate the Uconnect Phone from idle, simply push the Phone button (if active) on your steering wheel and say a command or say “Help”. All Phone sessions begin with a push of the VR button or the Phone button.

## CANCEL COMMAND

At any prompt, after the beep, you can say “Cancel” and you will be returned to the main menu.

You can also push the VR button or Phone button on your steering wheel when the system is listening for a command and be returned to the main or previous menu.

## PAIR (LINK) UCONNECT PHONE TO A MOBILE PHONE

Use this QR code to access your digital experience.



To begin using your Uconnect Phone, you must pair your compatible Bluetooth®-enabled mobile phone. Mobile phone pairing is the process of establishing a wireless connection between a cellular phone and the Uconnect system.

To complete the pairing process, you will need to reference your mobile phone’s manual. Please visit [UconnectPhone.com](http://UconnectPhone.com) for complete mobile phone compatibility information.

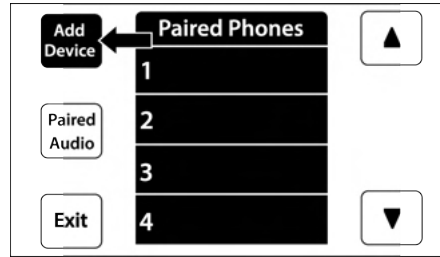

Uconnect 3 With 5-inch Display



Uconnect 4 With 7-inch Display

### NOTE:

- You must have Bluetooth® enabled on your phone to complete this procedure.
- The vehicle must be in PARK or at a standstill.

Follow these steps to pair your phone:

1. Place the ignition in the ACC or ON/RUN position.
2. Press the Phone button.

### NOTE:

- If there are no phones currently connected with the system, a pop-up will appear asking if you would like to pair a mobile phone.
- This pop-up only appears when the user enters Phone Mode and no other device(s) have previously been paired. If the system has a phone previously paired, even if no phone is currently connected with the system, this pop-up will not appear.

3. Select “Yes” to begin the pairing process.

4. Search for available devices on your Bluetooth®-enabled mobile phone.

- Press the Settings button on your mobile phone.
- Select “Bluetooth®” and ensure it is enabled. Once enabled, the mobile phone will begin to search for Bluetooth® connections.

### NOTE:

During the pairing procedure, you may receive a pop-up on your touchscreen asking you to make sure the PIN on the touchscreen matches the PIN from the pop-up on your mobile phone.

5. If “No” is selected, and you still would like to pair a mobile phone, press the Phone Pairing or Settings button from the Uconnect Phone main screen.
  - Press the Paired Phones button or the Add Device button.
  - Search for available devices on your Bluetooth®-enabled mobile phone. When prompted on the phone, select “Uconnect” and accept the connection request.
6. Uconnect Phone will display an in-progress screen while the system is connecting.
7. When your mobile phone finds the Uconnect system, select “Uconnect.”
8. When prompted on the mobile phone, accept the connection request from Uconnect.
9. When the pairing process has successfully completed, the system will prompt you to choose whether or not this is your favorite phone. Selecting “Yes” will make this phone the highest priority. This phone will take precedence over other paired phones within range and will connect to the Uconnect system automatically when entering the vehicle. Only one mobile phone and/or one Bluetooth® audio device can be connected to the Uconnect system at a time. If “No” is selected, simply select “Uconnect” from the mobile

phone/audio device Bluetooth® screen, and the Uconnect system will reconnect to the Bluetooth® device.

**NOTE:**

For phones which are not made a favorite, the phone priority is determined by the order in which it was paired. The most recent phone paired will have the higher priority.

**NOTE:**

During the pairing procedure, you may receive a pop-up on your mobile phone for the Uconnect system to access your “messages” and “contacts”. Selecting “Ok” or “Allow” will sync your contacts with the Uconnect system.

You can also use the following VR command to bring up the Paired Phone screen from any screen on the radio:

- “Show Paired Phones”

**NOTE:**

Software updates on your phone or the Uconnect system may interfere with the Bluetooth® connection. If this happens, simply repeat the pairing process. However, first make sure to delete the device from the list of phones on your Uconnect system. Next, be sure to remove Uconnect from the list of devices in your phone’s Bluetooth® settings.

**PAIR A BLUETOOTH® STREAMING AUDIO DEVICE**

For information on how to pair a Bluetooth® streaming audio device with the Uconnect 3 With 5-inch Display radio ↪ page 241.

1. Press the Media button on the touchscreen to begin.
2. Change the source to “Bluetooth®”.
3. Press the Bluetooth® button on the touchscreen to display the Paired Audio Devices screen.
4. Press the Add Device button on the touchscreen.

**NOTE:**

If there is no device currently connected with the system, a pop-up will appear.

5. Search for available devices on your Bluetooth®-enabled audio device. When prompted on the device, confirm the PIN shown on the Uconnect screen.
6. Uconnect Phone will display an in-process screen while the system is connecting.
7. When the pairing process has successfully completed, the system will prompt you to choose whether or not this is your favorite device. Selecting “Yes” will make this device the highest priority. This device will take precedence over other paired devices within range.

**NOTE:**

For devices which are not made a favorite, the device priority is determined by the order in which it was paired. The most recent device paired will have the higher priority.

You can also use a following VR command to bring up a list of paired audio devices:

- “Show Paired Phones”

### CONNECTING TO A PARTICULAR MOBILE PHONE OR AUDIO DEVICE AFTER PAIRING

Uconnect Phone will automatically connect to the highest priority paired phone and/or Audio Device within range. If you need to choose a particular phone or audio device follow these steps:

1. Press the Settings button on the touchscreen.
2. Press the Paired Phones or Audio Sources button.
3. Press to select the particular phone or the particular audio device. A pop-up menu will appear; press “Connect Phone”.
4. Press the X to exit out of the Settings screen.

### DISCONNECTING OR DELETING A PHONE OR AUDIO DEVICE

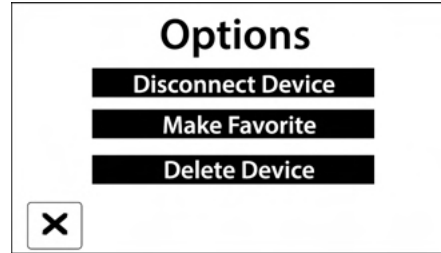

Uconnect 3 With 5-inch Display



Uconnect 4 With 7-inch Display

1. Press the Uconnect Phone Pairing or Settings button.
2. Press the Paired Phones or Audio Sources button.
3. Press the Settings button located to the right of the device name for a different phone or audio device than the currently connected device or press the preferred Connected Phone from the list.
4. The option's pop-up will be displayed.
5. Press the Disconnect Device or the Delete Device button on the touchscreen.
6. Press the X to exit out of the Settings screen.

### MAKING A PHONE OR AUDIO DEVICE A FAVORITE

1. On the Paired Phone/Audio Sources screen, press the Settings button located to the right of the device name for a different phone or audio device than the currently connected device or press the preferred “Connected Phone” from the list.
2. The option's pop-up will be displayed.
3. Press the Make Favorite button on the touchscreen; you will see the chosen device move to the top of the list.
4. Press the X to exit out of the Settings screen.

## PHONEBOOK DOWNLOAD (AUTOMATIC PHONEBOOK TRANSFER FROM MOBILE PHONE) — IF EQUIPPED

If supported by your phone, Uconnect Phone has the ability to download contact names and number entries from the mobile phone's phonebook. Specific Bluetooth® Phones with Phonebook Access Profile may support this feature. Your mobile phone may receive a pop-up asking for permission for the Uconnect system to access your messages and contacts. Selecting "Ok" or "Allow" will sync your contacts with the Uconnect system. See the Uconnect website, UconnectPhone.com, for supported phones.

- To call a name from a downloaded mobile phonebook, ➔ page 248.
- Automatic download and update of a phonebook, if supported, begins as soon as the Bluetooth® wireless phone connection is made to the Uconnect Phone, for example, after you start the vehicle.
- A maximum of 5,000 contact names with four numbers per contact will be downloaded and updated every time a phone is connected to the Uconnect Phone.
- Depending on the maximum number of entries downloaded, there may be a short delay before the latest downloaded names can be used. Until

then, if available, the previously downloaded phonebook is available for use.

- Only the phonebook of the currently connected mobile phone is accessible.
- This downloaded phonebook cannot be edited or deleted on the Uconnect Phone. These can only be edited on the mobile phone. The changes are transferred and updated to Uconnect Phone on the next phone connection.

## MANAGING YOUR FAVORITES — IF EQUIPPED

There are two ways you can add an entry to your favorites:

1. After loading the mobile phonebook, press the Favorites button on the touchscreen, and then press one of the +Add Favorite Contact buttons that appears on the list.
2. After loading the mobile phonebook, select "Contacts" from the Phone main screen, and then select the appropriate number. Press the Down Arrow button or the Settings Gear button next to the selected number to display the option's pop-up. In the pop-up, select "Add to Favorites".

### NOTE:

If the Favorites list is full, you will be asked to remove an existing favorite.

## TO REMOVE A FAVORITE — IF EQUIPPED

1. To remove a Favorite, select "Favorites" from the Phone main screen.
2. Next, select the Down Arrow icon or the Settings Gear icon next to the contact you want to remove from your favorites. This will bring up the options for that Favorite contact.
3. Deselect the Star icon to delete the Favorite.

## Phone Call Features

The following features can be accessed through the Uconnect Phone if the feature(s) are available and supported by Bluetooth® on your mobile service plan. For example, if your mobile service plan provides three-way calling, this feature can be accessed through the Uconnect Phone. Check with your mobile service provider for the features that you have.

Here are the phone options with Uconnect:

- Redial
- Dial by pressing in the number
- Voice Commands (Dial by Saying a Name, Call by Saying a Phonebook Name, Redial or Call Back)
- Favorites
- Mobile Phonebook
- Recent Call Log
- SMS Message Viewer

## CALL CONTROLS

The touchscreen allows you to control the following call features:



- 1 – Answer
- 2 – Mute/Unmute
- 3 – Ignore
- 4 – Transfer

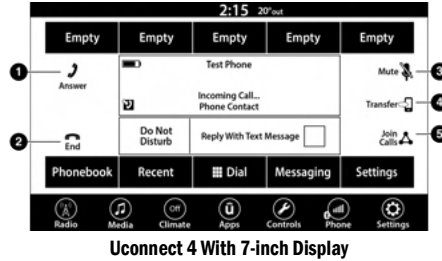

- 1 – Answer
- 2 – End
- 3 – Mute/Unmute
- 4 – Transfer
- 5 – Join Calls

Other phone call features include:

- End Call
- Hold/Unhold/Resume
- Swap two active calls

## KEY PAD NUMBER ENTRY

1. Press the Phone button.
2. Press the Dial/Keypad button on the touchscreen.
3. The Touch-Tone screen will be displayed.
4. Use the numbered buttons on the touchscreens to enter the number and press “Dial/Call”.

## RECENT CALLS – IF EQUIPPED

You may browse a list of the most recent of each of the following call types:

- All Calls
- Incoming Calls or Calls Received
- Outgoing Calls or Calls Made
- Missed Calls

These can be accessed by pressing the Recent Calls button on the phone main screen.

You can also push the VR button on your steering wheel and perform the above operation. For example, say “Show my incoming calls”.

## ANSWER OR IGNORE AN INCOMING CALL — NO CALL CURRENTLY IN PROGRESS

When you receive a call on your mobile phone, the Uconnect Phone will interrupt the vehicle audio system. Push the Phone button on the steering wheel, press the Answer button on the touchscreen.

You can also press the Caller ID box to place the current call on hold or answer the incoming call.

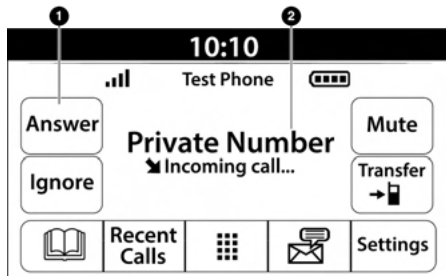

**Uconnect 3 With 5-inch Display**

- 1 — Answer Button
- 2 — Caller ID Box



**Uconnect 4 With 7-inch Display**

- 1 — Answer Button
- 2 — Caller ID Box

## ANSWER OR IGNORE AN INCOMING CALL — CALL CURRENTLY IN PROGRESS

If a call is currently in progress and you have another incoming call, you will hear the same network tones for call waiting that you normally hear when using your mobile phone. Push the Phone button on the steering wheel, press the Answer button on the touchscreen, or press the Caller ID box to place the current call on hold and answer the incoming call.

### NOTE:

Phones that are compatible with the Uconnect system in the market today do not support rejecting an incoming call when another call is in progress. Therefore, the user can only answer an incoming call or ignore it.

### DO NOT DISTURB

With Do Not Disturb, you can disable notifications from incoming calls and texts, allowing you to keep your eyes on the road and hands on the wheel. For your convenience, there is a counter display to keep track of your missed calls and text messages while Do Not Disturb is active.

Do Not Disturb can automatically reply with a text message, a call, or both when declining an incoming call and send it to voicemail.

Automatic reply messages can be:

- “I am driving right now, I will get back to you shortly”.
- Create a custom auto reply message up to 160 characters.

### NOTE:

Only the first 25 characters can be seen on the touchscreen while typing a custom message.



While in Do Not Disturb, “Conference Call” can be selected so you can still place a second call without being interrupted by incoming calls.

#### NOTE:

- Reply with text message is not compatible with iPhone® devices.
- Auto reply with text message is only available on phones that support Bluetooth® Message Access Profile (MAP).

#### PLACE/RETRIEVE A CALL FROM HOLD

During an active call, press the Hold or Call On Hold button on the Phone main screen.

#### MAKING A SECOND CALL WHILE CURRENT CALL IS IN PROGRESS

You can place a call on hold by pressing the Hold button on the Phone main screen, then dial a number from the keypad (if supported by your mobile phone), recent calls, SMS Inbox or from the phonebooks.

#### TOGGLING BETWEEN CALLS



Uconnect 3 With 5-inch Display



Uconnect 4 With 7-inch Display

If two calls are in progress (one active and one on hold), press the Swap Calls button on the phone main screen. Only one call can be placed on hold at a time.

You can also push the Phone button to toggle between the active and held phone call.

#### JOIN CALLS

When two calls are in progress (one active and one on hold), press the Join/Merge Calls button on the Phone main screen to combine all calls into a conference call.

#### CALL TERMINATION

To end a call in progress, momentarily press the End Call button on the touchscreen or the Phone End button on the steering wheel. Only the active call(s) will be terminated and if there is a call on hold, it will become the new active call.

#### REDIAL

Push the VR button and after the “Listening” prompt and the following beep, say “Redial.”

The Uconnect Phone will call the last number that was dialed from your mobile phone.

## CALL CONTINUATION

Call continuation is the progression of a phone call on the Uconnect Phone after the vehicle ignition has been switched to OFF.

### NOTE:

The call will remain within the vehicle audio system until the phone becomes out of range for the Bluetooth® connection. It is recommended to press the Transfer button on the touchscreen when leaving the vehicle.

## Advanced Phone Connectivity

### TRANSFER CALL TO AND FROM MOBILE PHONE

The Uconnect Phone allows ongoing calls to be transferred from your mobile phone without terminating the call. To transfer an ongoing call from your connected mobile phone to the Uconnect Phone or vice versa, press the Transfer button on the Phone main screen.

## Things You Should Know About Uconnect Phone

### VOICE COMMAND

For the best performance:

- Always wait for the beep before speaking
- Speak normally, without pausing, just as you would speak to a person sitting a few feet/meters away from you

- Ensure that no one other than you is speaking during a voice command period
- Low-To-Medium Blower Setting
- Low-To-Medium Vehicle Speed
- Low Road Noise
- Smooth Road Surface
- Fully Closed Windows
- Dry Weather Conditions

### WARNING!

ALWAYS drive safely with your hands on the wheel. You have full responsibility and assume all risks related to the use of the Uconnect features and applications in this vehicle. Only use Uconnect when it is safe to do so. Failure to do so may result in an accident involving serious injury or death.

Even though the system is designed for many languages and accents, the system may not always work for some.

### NOTE:

It is recommended that you do not store names in your Favorites phonebook while the vehicle is in motion.

Number and name recognition rate is optimized when the entries are not similar. You can say "0" (letter "O") for "0" (zero).

Even though international dialing for most number combinations is supported, some shortcut dialing number combinations may not be supported.

### Audio Performance

Audio quality is maximized under:

- Low-To-Medium Blower Setting
- Low-To-Medium Vehicle Speed
- Low Road Noise
- Smooth Road Surface
- Fully Closed Windows
- Dry Weather Conditions
- Operation From The Driver's Seat

Performance such as audio clarity, echo, and loudness to a large degree rely on the phone and network, and not the Uconnect Phone.

Echo at the far end can sometimes be reduced by lowering the in-vehicle audio volume.

### PHONE VOICE COMMANDS



Making and answering hands-free phone calls is easy with Uconnect. When the Phonebook button is illuminated on your touchscreen, your system is ready. Check [UconnectPhone.com](http://UconnectPhone.com) for mobile phone compatibility and pairing instructions.

Push the Phone button  and wait for the beep to say a command. Here are some examples:

- “Call John Smith”
- “Dial 123 456 7890”
- “Redial” (call previous outgoing phone number)
- “Call back” (call previously answered incoming phone number)

**Did You Know:** When providing a Voice Command, push the Phone button  and say “Call”, then pronounce the name **exactly** as it appears in your phonebook. When a contact has multiple phone numbers, you can say “Call John Smith **work**”.

### VOICE TEXT REPLY — IF EQUIPPED

Uconnect can announce **incoming** text messages. Push the VR button  or Phone button  and say:

1. “Listen” to have the system read an incoming text message. (Must have compatible mobile phone paired to Uconnect system.)
2. “Reply” after an incoming text message has been read.

Listen to the Uconnect prompts. After the beep, repeat one of the predefined messages and follow the system prompts.

PRE-DEFINED VOICE TEXT REPLY RESPONSES		
Yes.	Stuck in traffic.	See you later.
No.	Start without me.	I'll be late.
Okay.	Where are you?	I will be 5 <or 10, 15, 20, 25, 30, 45, 60> minutes late.
Call me.	Are you there yet?	
I'll call you later.	I need directions.	See you in 5 <or 10, 15, 20, 25, 30, 45, 60> minutes.
I'm on my way.	Can't talk right now.	
I'm lost.		Thanks.

#### NOTE:

Only use the numbering listed in the provided table. Otherwise, the system will not transpose the message.

**Did You Know:** Your mobile phone must have the full implementation of the **Message Access Profile (MAP)** to take advantage of this feature. For details about MAP, visit [UconnectPhone.com](http://UconnectPhone.com).

Apple® iPhone® iOS 5 or later supports reading **incoming** text messages only. For further information on how to enable this feature on your Apple® iPhone®, refer to your iPhone® “User Manual”.

**Did You Know:** Voice Text Reply is not compatible with iPhone®, but if your vehicle is equipped with Siri® Eyes Free, you can use your voice to send a text message.

### SIRI® EYES FREE — IF EQUIPPED

When used with your Apple® iPhone® connected to your vehicle via Bluetooth®, Siri lets you use your voice to send text messages, select media, place phone calls and much more. Siri uses your natural language to understand what you mean and responds back to confirm your requests. The system is designed to keep your eyes on the road and your hands on the wheel by letting Siri help you perform useful tasks.

To enable Siri, push and hold, then release the Uconnect Voice Recognition (VR) button on the steering wheel. After you hear a double beep, you can ask Siri to play podcasts and music, get directions, read text messages, and many other useful requests.

## BLUETOOTH® COMMUNICATION LINK

Mobile phones may lose connection to the Uconnect Phone. When this happens, the connection can generally be re-established by restarting the mobile phone. Your mobile phone is recommended to remain in Bluetooth® ON mode.

## POWER-UP

After switching the ignition key from OFF to either the ON/RUN or ACC position, or after a language change, you must wait at least 15 seconds prior to using the system ↪ page 431.

## ANDROID AUTO™ & APPLE CARPLAY® — IF EQUIPPED

### ANDROID AUTO™

Use this QR code to access your digital experience.

Android Auto™ is a feature of your Uconnect system, and your Android™ 6.0 or higher powered smartphone with a data plan, that allows you to project your smartphone and a number of its apps onto the touchscreen radio display. Android Auto™ brings you useful information, and organizes it into simple cards that appear just when they are needed. Android Auto™ can be used with speech



technology, the steering wheel controls, the knobs and buttons on your radio faceplate, and the radio display's touchscreen to control many of your apps. To use Android Auto™, perform the following procedure:

### NOTE:

Feature availability depends on your carrier and mobile phone manufacturer. Some Android Auto™ features may or may not be available in every region and/or language.

1. Download the Android Auto™ app from the Google Play store on your Android™-powered smartphone.
2. Connect your Android™-powered smartphone to one of the media USB ports in your vehicle. If the Android Auto™ app was not downloaded, the first time you plug your device in the app begins to download. Your vehicle should be in PARK the first time you use the app.

### NOTE:

Be sure to use the factory-provided USB cable that came with your phone, as aftermarket cables may not work.

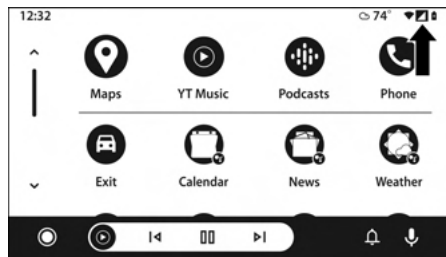

### Android Auto™ And LTE Data Coverage

### NOTE:

To use Android Auto™, make sure you are in an area with cellular coverage. Android Auto™ may use cellular data and your cellular coverage is shown in the upper right corner of the radio screen. Data plan rates apply.

3. Once the device is connected and recognized, the Phone icon on the drag & drop menu bar changes to the Android Auto™ icon.

### NOTE:

Android Auto™ is set to launch immediately once a compatible device is connected. You can also launch it by pressing the Android Auto™ icon on the touchscreen.

Once Android Auto™ is up and running on your Uconnect system, the following features can be utilized using your smartphone's data plan:

- Google Maps™ for navigation
- YouTube Music, Spotify, iHeart Radio, etc. for music
- Hands-free calling and texting for communication
- Various compatible apps

## Maps



Push and hold the Voice Recognition (VR) button on the steering wheel until the beep or tap the Microphone icon to ask Google to take you to a desired

destination by voice. You can also touch the Navigation icon in Android Auto™ to access other navigation apps.

While using Android Auto™, Google Maps™ provides voice-guided:

- Navigation
- Live traffic information
- Lane guidance

For further information, refer to [www.android.com/auto/](http://www.android.com/auto/) (US) or [https://www.android.com/intl/en\\_ca/auto/](https://www.android.com/intl/en_ca/auto/) (Canada).

For further information on the navigation function, please refer to <https://support.google.com/android> or <https://support.google.com/androidauto/>.

## Music



Android Auto™ allows you to access and stream your favorite music with apps like YouTube Music, iHeartRadio, and Spotify. Using your smartphone's data plan, you can stream endless music on the road.

### NOTE:

Music apps, playlists, and stations must be set up on your smartphone prior to using Android Auto™ for them to work with Android Auto™.

### NOTE:

To see the track details for the music playing through Android Auto™, select the Uconnect system's media screen.

For further information, refer to <https://support.google.com/androidauto>.

## Communication



With Android Auto™ connected, push and hold the VR button on the steering wheel to activate voice recognition specific to Android Auto™. This allows you to send and reply to text messages, have incoming text messages read out loud, and place and receive hands-free calls.

## Apps

The Android Auto™ App displays all the compatible apps that are available to use with Android Auto™, every time it is launched. You must have the compatible app downloaded, and you must be signed in to the app through your mobile device for it to work with Android Auto™.

Refer to <https://play.google.com/store/apps/> to see the latest list of available apps for Android Auto™.

## Android Auto™ Voice Command

### NOTE:

Feature availability depends on your carrier and mobile phone manufacturer. Some Android Auto™ features may or may not be available in every region and/or language.

Android Auto™ allows you to use your voice to interact with its best-in-class speech technology through your vehicle's voice recognition system, and use your smartphone's data plan to project your Android™-powered smartphone and a number of its apps onto your Uconnect touchscreen. Connect your Android™ 6.0 or higher to one of the media USB ports, using the factory-provided USB cable, and press the new Android Auto™ icon that replaces your Phone icon on the main menu bar to begin Android Auto™.

Push and hold the VR button on the steering wheel, or press and hold the Microphone icon within Android Auto™, to activate its VR, which recognizes natural voice commands, to use a list of your smartphone's features:

- Maps
- Music
- Phone
- Text Messages
- Additional Apps

**NOTE:**

- To use Android Auto™ on your car display, you'll need an Android™ phone running Android™ 6.0 or higher, an active data plan, and the Android Auto™ app.
- To wirelessly use Android Auto™ on your car display, you need a compatible Android™ smartphone with an active data plan. You can check which smartphones are compatible at [g.co/androidauto/requirements](http://g.co/androidauto/requirements).

Android™ is a trademark of Google Inc.

## APPLE CARPLAY®

**Use this QR code to access your digital experience.**



Uconnect works seamlessly with Apple CarPlay®, the smarter, more secure way to use your iPhone® in the car, and stay focused on the road. Use your Uconnect Touchscreen display, the vehicle's knobs and controls, and your voice with Siri to get access to Apple Music®, Maps, Messages, and more.

**NOTE:**

Feature availability depends on your carrier and mobile phone manufacturer. Some Apple CarPlay® features may or may not be available in every region and/or language.

To use Apple CarPlay®, make sure you are using iPhone® 5 or later, have Siri enabled in Settings, ensure your iPhone® is unlocked for the very first connection only, and then use the following procedure:

1. Connect your iPhone® to one of the media USB ports in your vehicle.

**NOTE:**

Be sure to use the factory-provided Lightning cable that came with your phone, as aftermarket cables may not work.

2. Once the device is connected and recognized, the Phone icon on the drag & drop menu bar changes to the Apple CarPlay® Icon.

**NOTE:**

Apple CarPlay® is set to launch immediately. You can also launch it by pressing the Apple CarPlay® icon on the touchscreen.

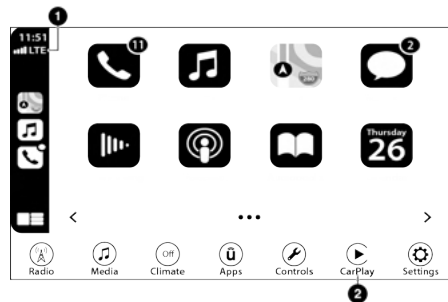

**Apple CarPlay® And LTE Data Coverage**

1 – LTE Data Coverage

2 – Apple CarPlay® Icon

**NOTE:**

To use Apple CarPlay®, make sure that cellular data is turned on, and that you are in an area with cellular coverage. Your data and cellular coverage is shown on the left side of the radio screen. Data plan rates apply.

Once Apple CarPlay® is up and running on your Uconnect system, the following features can be utilized using your iPhone® data plan:

- Phone
- Music
- Messages
- Maps

## Phone



With Apple CarPlay®, push and hold the VR button on the steering wheel to activate a Siri voice recognition session.

You can also press and hold the Home button within Apple CarPlay® to start talking to Siri. This allows you to make calls or listen to voicemail as you normally would using Siri on your iPhone®.

### NOTE:

Only temporarily pushing the VR button on the steering wheel launches a built-in Uconnect VR session, not a Siri session, and it will not function with Apple CarPlay®.

## Music



Apple CarPlay® allows you to access all your artists, playlists, and music from iTunes® or any third party application installed on your device. Using your

iPhone® data plan, you can also use select third party audio apps including music, news, sports, podcasts, and more.

## Messages



Push and hold the VR button on the steering wheel to activate a Siri voice recognition session. Apple CarPlay® allows you to use Siri to send or reply to text messages. Siri can also read incoming text messages, but drivers will not be able to read messages, as everything is done via voice.

## Maps



Push and hold the VR button on the steering wheel until the beep or tap the Microphone icon to ask Apple® Siri to take you to a desired destination by voice. You can also touch the Navigation icon in Apple CarPlay® to access Apple® Maps.

## Apps

The Apple CarPlay® App plays all compatible apps that are available to use, every time it is launched. You must have the compatible app downloaded, and you must be signed in to the app through your mobile device for it to work with Apple CarPlay®.

Refer to <http://www.apple.com/ios/carplay/> (US) or <https://www.apple.com/ca/ios/carplay/> (Canada) to see the latest list of available apps for Apple CarPlay®.

## Apple CarPlay® Voice Command

### NOTE:

Feature availability depends on your carrier and mobile phone maker. Some Apple CarPlay® features may not be available in every region and/or language.

Apple CarPlay® allows you to use your voice to interact with Siri through your vehicle's voice recognition system, and use your smartphone's data plan to project your iPhone® and a number of its apps onto your Uconnect touchscreen. Connect your iPhone® 5 or higher to one of the media USB ports, using the factory-provided Lightning cable, and press the new Apple CarPlay® icon that replaces your Phone icon on the main menu bar to begin Apple CarPlay®. Push and hold the VR button on the steering wheel, or press and hold the Home button within Apple CarPlay®, to activate Siri, which recognizes natural voice commands to use a list of your iPhone® features:

- Phone
- Music
- Messages
- Maps — If Equipped
- Additional Apps — If Equipped

### NOTE:

Apple CarPlay® is a trademark of Apple® Inc. iPhone® is a trademark of Apple® Inc., registered in the US and other countries. Apple® terms of use and privacy statements apply.

## ANDROID AUTO™ AND APPLE CARPLAY® TIPS AND TRICKS

### Android Auto™ And Apple CarPlay® Automatic Bluetooth® Pairing

After connecting to Android Auto™ or Apple CarPlay® for the first time and undergoing the setup procedure, the smartphone pairs to the Uconnect system via Bluetooth® without any setup required every time it is within range, if Bluetooth® is turned on.

#### NOTE:

Apple CarPlay® uses a USB connection while Android Auto™ uses both USB and Bluetooth® connections to function. The connected device is unavailable to other devices when connected using Android Auto™ or Apple CarPlay®.

### Multiple Devices Connecting To The Uconnect System — If Equipped

It is possible to have multiple devices connected to the Uconnect system. For example, if using Android Auto™/Apple CarPlay®, the connected device will be used to place hands-free phone calls or send hands-free text messages. However, another device can also be paired to the Uconnect system, via Bluetooth®, as an audio source, so the passenger can stream music.

#### NOTE:

Apple CarPlay® and Android Auto™ can only be launched from the front and center console USB ports.

## CONNECTED VEHICLE SERVICES — IF EQUIPPED

### IS MY VEHICLE CONNECTED?

**If equipped, vehicles with an ASSIST and an SOS button are connected vehicles. These buttons will be located on either the rearview mirror or overhead console, depending on the vehicle. If these buttons are present in your vehicle, you have a connected radio and can take advantage of the many connected vehicle features.**

For further information about the ASSIST and SOS buttons ↪ page 330.

## INTRODUCTION TO CONNECTED VEHICLE SERVICES

One of the many benefits of your vehicle's Uconnect system is that you can now take advantage of SiriusXM Guardian™ connected services. To unlock the full potential of SiriusXM Guardian™ in your vehicle, you first need to activate SiriusXM Guardian™ connected services.

#### WARNING!

ALWAYS obey traffic laws and pay attention to the road. ALWAYS drive safely with your hands on the steering wheel. You have full responsibility and assume all risks related to the use of the features and applications in this vehicle. Only use the features and applications when it is safe to do so. Failure to comply may result in an accident involving serious injury or death.

#### NOTE:

SiriusXM Guardian™ involves the collection, transmission and use of data from your vehicle ↪ page 271.

### SiriusXM Guardian™ Contact Information

#### SiriusXM Guardian™/Care

- US residents visit: <https://www.driveuconnect.com/sirius-xm-guardian.html> or call 1-844-796-4827
- Canadian residents visit: <https://www.driveuconnect.ca/en/sirius-xm-guardian> or call 1-877-324-9091

### What Is SiriusXM Guardian™?

SiriusXM Guardian™ uses an embedded device in the Uconnect system installed in your vehicle, which receives GPS signals and communicates with the SiriusXM Guardian™ Customer Care center via wireless and landline communications



networks. Depending on the type of device in your vehicle, some SiriusXM Guardian™ connected services require an operable LTE (voice/data) or 3G or 4G (data) network compatible with your device. SiriusXM Guardian™ is available only on equipped vehicles purchased within the continental United States, Alaska, Hawaii, Puerto Rico and Canada.

#### NOTE:

- Certain SiriusXM Guardian™ connected services are dependent upon an operative telematics device, a cellular connection, navigation map data, and GPS satellite signal reception, which can limit the ability to reach the response center or reach emergency support.
- Not all features of SiriusXM Guardian™ are available everywhere at all times, particularly in remote or enclosed areas.
- Other factors outside the control of SiriusXM Guardian™ that may limit or prevent service delivery are hills, structures, buildings, tunnels, weather, damage to the electrical system or other important parts of your vehicle, network congestion, civil disturbances, actions of third parties or the government, Internet failure, and/or the physical location of your vehicle, such as in an underground parking structure or under a bridge.

Not all SiriusXM Guardian™ features are available for all models.

SiriusXM Guardian™ provides:

- The ability to remotely lock/unlock and remote start your vehicle from virtually anywhere by using the Mobile App or your computer.
- If equipped — Send & Go capability with the Mobile App. Use the Mobile App to easily search, map and send your locations directly to your Uconnect Navigation.
- The ability to locate your vehicle, when you forget where you parked, using the Vehicle Finder function of the Mobile App.

Before you drive, familiarize yourself with the easy-to-use Uconnect system and SiriusXM Guardian™ connected services.

#### The ASSIST and SOS Call Buttons On Your Rearview Mirror Or Overhead Console

If equipped, the ASSIST Button is used for contacting Roadside Assistance, Vehicle Care, Uconnect Care, and SiriusXM Guardian™ Customer Care. The SOS Call button connects you directly to SiriusXM Guardian™ Customer Care for assistance in an emergency.

#### Activation — If Equipped

To unlock the full potential of SiriusXM Guardian™ in your vehicle, you must activate your SiriusXM Guardian™ connected services.

1. Press the Apps icon on the bottom of your in-vehicle touchscreen.
2. Select the Activate Services icon from your list of apps.
3. **For customers in the United States**, select “Customer Care” to speak with a SiriusXM Guardian™ Customer Care agent who will activate services in your vehicle, or select “Enter Email” to activate on the web.

**For customers in Canada**, enter your email address to activate services in your vehicle.

5

#### Included Trial Period For New Vehicles

Your new vehicle may come with an included trial\* period for use of SiriusXM Guardian™ connected services starting on the date of vehicle purchase. To get started with your trial, enrollment in SiriusXM Guardian™ is required.

\* Included trial applies to new vehicles only.

#### Features And Packages

After the trial period, you must purchase a subscription to continue your services by calling a SiriusXM Guardian™ Customer Care agent.

## GETTING STARTED WITH CONNECTED VEHICLE SERVICES

### Download The Mobile App

Once you have activated your services, you're only a few steps away from using connected services.

- Download the Mobile App to your mobile device.
- Use your Owner Account login and password to open the app and then set up a PIN.



A0401000291US

- For customers in the United States, visit [www.mopar.com](http://www.mopar.com), and click the Sign In/Register button in the upper right-hand corner to register your account online.
  - a. Click the Register button.
  - b. Select the correct country and email address then click "Register".
  - c. You will then receive an email notification to confirm/verify your newly created account.
- For customers in Canada, register your account via your vehicle.
  - a. Press the Apps button in the bottom menu bar.
  - b. Press the Activate Services button from the apps list.
  - c. Enter your email and press "OK". A confirmation email will be sent to the provided email address.
  - d. Press "Continue Activation" from the confirmation email. It may take a short time before remote services will be available, but you will be able to log into the Mobile App and the Owner's Site.
- Once on the Remote screen and you have set up your four-digit PIN, you can begin using Remote Door Lock/Unlock, Remote Vehicle Start, and activate your horn and lights remotely, if equipped.
- Press the Location button on the bottom menu bar of the app to bring up a map to locate your vehicle or send a location to your Mobile Navigation, if equipped.
  - d. After clicking the email link, it will take you to a website and prompt you to assign your account with a password.
  - e. Once you have added a password, the website will direct you to your homepage where you can add in your VIN.
- Press the Settings side menu in the upper left corner of the app to bring up app settings and access the Assist Call Centers.

### Using Your Owner's Site

Your Owner's Site website <https://www.mopar.com/en-us.html> (US Residents), or [www.mopar.ca](https://www.mopar.ca) (Canadian Residents) provides you with all the information you need, all in one place. You can track your service history, find recommended accessories for your vehicle, watch videos about your vehicle's features, and easily access your manuals. It is also where you can manage your SiriusXM Guardian™ account. This section will familiarize you with the key elements of the website that will help you get the most of your SiriusXM Guardian™ connected services.

For customers in the United States, press the Sign In/Register button and enter your email address and password.

For customers in Canada, press the My Vehicle button. Select from "Dashboard", "Vehicle Health Report", and "Recalls". The website will then prompt you to log in using your email address and password.

#### ● Edit/Edit Profile:

To manage the details of your SiriusXM Guardian™ account, such as your contact information, password and SiriusXM Guardian™ PIN, click on the Edit/Edit Profile button to access the details of your account.

### ● Connected Services Status:

This statement will indicate your SiriusXM Guardian™-equipped vehicle.

### ● Remote Commands:

For vehicles with an active SiriusXM Guardian™ subscription, press one of these icons and enter your four-digit SiriusXM Guardian™ Security PIN to remotely start (if equipped), lock/unlock doors or sound the horn and flash the lights.

### Editing Your Notifications

Notifications are an important element of your SiriusXM Guardian™ account. For example, any time you use your remote services (such as Remote Door Unlock), you can elect to receive a text message, push notification, and/or E-mail to notify you of the event. To set up the notifications, please follow these instructions:

1. Log on to your Owner's Account at <https://www.mopar.com/en-us.html> (US Residents) and select "Dashboard", or [www.mopar.ca](http://www.mopar.ca) (Canadian Residents), select "My Vehicle" and then "Dashboard".
2. Click the Edit/Edit Profile button.
3. Once there, select "SiriusXM Guardian™" where you can edit Notification Preferences.
4. You can enter a mobile phone and/or email address to notify you, and you can customize the types of messages.

## USING SIRIUSXM GUARDIAN™

### SOS Call — If Equipped

#### WARNING!

Some SiriusXM Guardian™ connected services, including SOS Call and Roadside Assistance Call, will NOT work without a network connection compatible with your device.

### Access To Emergency Services At The Push Of A Button

Center Light Status	Description
Off	No call activated
Green	Active call in progress
Red	System error

### SiriusXM Guardian™ In-Vehicle Assistance Features

With SiriusXM Guardian™, your vehicle has onboard assistance features located on the rearview mirror or overhead console designed to enhance your driving experience if you should ever need assistance or support.

#### Description

SOS Call offers a convenient way to get in contact with a SiriusXM Guardian™ Customer Care agent

in the event of an emergency. When the connection between the vehicle and the live agent is made, your vehicle will automatically transmit location information. In the event of a minor collision, medical or any other emergency, press the SOS button to be connected to a call center agent who can send emergency assistance to your vehicle's location.

#### NOTE:

Certain SiriusXM Guardian™ connected services are dependent on an operational Uconnect system, cellular network availability that is compatible with the device in your vehicle, and GPS network availability. Not all features of SiriusXM Guardian™ are available everywhere at all times, particularly in remote or enclosed areas.

#### How It Works

1. Push the SOS Call button; the indicator light will turn green indicating a call has been placed.

#### NOTE:

- In case the SOS Call button is accidentally pushed, there is a 10-second delay before the SOS call is placed. The system will verbally alert you that a call is about to be made. To cancel the SOS Call connection, push the SOS Call button on the rearview mirror or overhead console or press the Cancel button on the touchscreen within 10 seconds.

- During an SOS Call, the Bluetooth®-paired phone is disconnected so incoming or outgoing calls will go through your mobile device versus the hands-free system which is not available due to the SOS Call.
2. Once a connection between the vehicle and a SiriusXM Guardian™ Customer Care agent is made, the agent will stay on the line with you.

**NOTE:**

Calls between the vehicle occupants and the SiriusXM Guardian™ Customer Care center may be recorded or monitored for quality assurance purposes. Through your enrollment in and use of the SiriusXM Guardian™ connected services, you consent to being recorded.

**SOS Call System Limitations**

Vehicles that have been purchased in the US and that travel into Mexico and Canada may have limited services. In particular, responses to SOS calls or other emergency services may be unavailable or very limited. Vehicles purchased outside the United States and Canada are unable to receive SiriusXM Guardian™ connected services.

If the SOS Call system detects a malfunction, any of the following may occur at the time the malfunction is detected:

- The light will continuously be illuminated red.
- The screen will display the following message “Vehicle phone requires service. Please contact your dealer.”
- An in-vehicle audio message will state “Vehicle phone requires service. Please contact your dealer.”

Even if the SOS Call system is fully functional, factors beyond FCA US LLC’s control may prevent or stop SOS Call system operation. These include, but are not limited to, the following factors:

- The ignition key is in OFF position.
- The vehicle’s electrical systems are not intact.
- The vehicle battery loses power or becomes disconnected during a vehicle crash.
- The SOS Call system software and/or hardware is damaged during a vehicle crash.
- LTE (voice/data) or 3G or 4G (data) coverage and/or GPS signals are unavailable or obstructed.
- Network congestion.
- Weather conditions.
- Buildings, structures, geographic terrain, or tunnels.

If your vehicle loses battery power for any reason (including during or after an accident), the SOS Call system, among other vehicle systems, will not operate.

**Requirements**

- This feature is available only on vehicles sold in the US or Canada.
- Vehicle must be properly equipped with the SiriusXM Guardian™ connected services. Vehicle must be registered with SiriusXM Guardian™ and have an active subscription that includes the applicable feature.
- Vehicle must have an operable LTE (voice/data) or 3G or 4G (data) network connection compatible with your device.
- Vehicle must be powered in the ON/RUN or ACC (Accessory) position with a properly functioning electrical system.

**WARNING!**

- Never place anything on or near the vehicle’s LTE (voice/data) or 3G or 4G (data) and GPS antennas. You could prevent LTE (voice/data) or 4G (data) and GPS signal reception, which can prevent your vehicle from placing an emergency call.

*(Continued)*

**WARNING!**

- Do not add any aftermarket electrical equipment to the vehicle's electrical system. This may prevent your vehicle from sending a signal to initiate an emergency call. To avoid interference that can cause the SOS Call system to fail, never add aftermarket equipment (e.g., two-way mobile radio, CB radio, data recorder, etc.) to your vehicle's electrical system or modify the antennas on your vehicle. **IF YOUR VEHICLE LOSES POWER FOR ANY REASON (INCLUDING DURING OR AFTER AN ACCIDENT), NEITHER THE MOBILE APPS NOR THE SIRIUSXM GUARDIAN™ CONNECTED SERVICES WILL OPERATE.**
- The Occupant Restraint Controller (ORC) turns on the Air Bag Warning Light on the instrument panel if a malfunction in any part of the air bag system is detected. If the Air Bag Warning Light is illuminated, the air bag system may not be working properly and the SOS Call system may not be able to send a signal to the SiriusXM Guardian™ Customer Care center. If the Air Bag Warning Light is illuminated, have an authorized dealer service your vehicle immediately.

*(Continued)***WARNING!**

- Ignoring the Rearview Mirror Light could mean you will not have SOS Call services if needed. If the Rearview Mirror Light is illuminated, have an authorized dealer service the SOS Call system immediately.
- If anyone in the vehicle could be in danger (e.g., fire or smoke is visible, dangerous road conditions or location), do not wait for voice contact from a SiriusXM Guardian™ Customer Care agent. All occupants should exit the vehicle immediately and move to a safe location.
- Failure to perform scheduled maintenance and regular inspection of your vehicle may result in vehicle damage, accident or injury.

**Automatic SOS — If Equipped**

Automatic SOS is a hands-free safety service that can immediately connect you with help in the event that your vehicle's airbags deploy. After an accident, a live agent will contact you through the Uconnect system and alert emergency services.

**NOTE:**

An active SiriusXM Guardian™ subscription is required for this feature to function. After a crash where the airbags deploy:

1. Automatic SOS will initiate a call with an agent.
2. An agent will receive the call and confirm the location of the emergency.
3. If needed, the agent will request the assistance of emergency services.
4. First responders will arrive on scene. The agent will remain on the call until emergency services arrive.

**NOTE:**

- Agents are available 24/7 to assist you in the case of an emergency.
- On your behalf, agents are able to notify family members about the collision.
- Agents can brief first responders of the situation before they arrive on scene.
- In the event vehicle occupants are unable to speak, emergency services will be dispatched based on the last known GPS coordinates.
- SiriusXM Guardian™ connected services are dependent upon an operative telematics device, a cellular connection, navigation map data, and GPS satellite reception, which can limit the ability to reach the response center or reach emergency support.
- Terms of service of the Uconnect and the SiriusXM Guardian™ subscriber agreement apply. See terms of services for complete service limitation.

## Remote Commands

On the Remote Commands screen, you have access to several vehicle features that can be controlled remotely from your mobile device. These features include locking/unlocking, remote starting, and activating the horn and lights of the vehicle.

Lock	Press this button to lock your vehicle.
Vehicle Start	Press this button to start your vehicle.
Horn & Lights	Press this button to sound the horn and activate your lights.
Unlock	Press this button to unlock your vehicle.
Cancel Vehicle Start	Press this button to cancel remote start.

Remote Commands lets you send a request to your vehicle in one of three ways:

- Anywhere using your mobile device and Mobile App
- From your computer on the Owner's Site (not available on all functions)
- Contacting SiriusXM Guardian™ Customer Care (not available on all functions)

### Using A Remote Command Through Your Mobile Device And The Mobile App

1. Press the desired Remote Command icon on your mobile device.
2. A pop-up screen will appear asking for your SiriusXM Guardian™ Security PIN (this is the same four-digit code established when you activated your SiriusXM Guardian™ connected services). Enter the SiriusXM Guardian™ Security PIN on the keypad.
3. It may take 30 seconds or more for the command to go through to your vehicle.
4. A message will let you know if the command was received by your vehicle.

### Using A Remote Command Through Your Owner's Site

1. Log on to your Owner's Site using the username and password you used when activating your SiriusXM Guardian™ connected services in your vehicle.

#### NOTE:

If you forgot your username or password, links are provided on the website to help you retrieve them.

2. If you have more than one vehicle registered into your Owner's Site, select the vehicle you want to send the command to by clicking on its image along the top.

3. On your dashboard, you will see remote commands. Press the desired icon to activate that feature.
4. You will then be asked to enter your SiriusXM Guardian™ Security PIN (this is the same four-digit code established when you activated your SiriusXM Guardian™ connected services). Please enter your SiriusXM Guardian™ Security PIN.
5. A message will appear on the screen to let you know if the command was received by your vehicle.

### Contacting SiriusXM Guardian™ Customer Care (for example, in case of an accidental lock-out):

1. Contact SiriusXM Guardian™ Customer Care if you are unable to lock your vehicle through the Mobile App or your key fob.
2. For security purposes, the SiriusXM Guardian™ Customer Care agent will verify your identity by asking for your four-digit SiriusXM Guardian™ Security PIN.
3. After providing your SiriusXM Guardian™ Security PIN, you can ask them to perform a remote command.

#### NOTE:

Anyone with access to your PIN may request Remote Door Lock/Unlock. It is your responsibility to protect your PIN appropriately.

## Remote Door Lock/Unlock

### Description

The Remote Door Lock/Unlock feature provides you the ability to lock or unlock the door on your vehicle without the keys and from virtually any distance.

### Working Vehicle Conditions

- The vehicle must be in PARK or at a standstill.
- The vehicle must be in an open area with cell tower reception.
- Your mobile device must have a cellular or Wi-Fi connection.

### Requirements

- Vehicle must be properly equipped with SiriusXM Guardian™.
- Vehicle must have an operable LTE (voice/data) or 3G or 4G (data) network connection. If using the Mobile App to command your vehicle, your device must be compatible and be connected to an operable LTE (voice/data) or 3G or 4G (data) network connection.
- Vehicle must be registered with SiriusXM Guardian™ and have an active subscription that includes the applicable feature.
- An ignition cycle is required for some remote commands, such as Remote Vehicle Start and

Remote Door Lock/Unlock if following a Remote Horn & Lights activation.

- Your Remote Door Lock/Unlock request will not be processed if the vehicle is in motion, the ignition key is on or during an emergency call.

### NOTE:

All other remote services should be performed via your Owner's Site or through the Mobile App on your compatible device.

## Remote Vehicle Start

### Description

The Remote Vehicle Start feature provides you with the ability to start the engine on your vehicle without the keys and from virtually any distance. Once started, the preset climate controls in your vehicle can warm up or cool down the interior.

You can also send a command to turn off an engine that has been started using Remote Vehicle Start. After 15 minutes, if you have not entered your vehicle with the key, the engine will shut off automatically.

This remote function requires your vehicle to be equipped with a factory-installed Remote Start system.

You can set up push notifications every time a command is sent to activate or cancel Remote Start.

### Working Vehicle Conditions

- The vehicle must be off or in ACC mode.
- The vehicle has been started with the key fob within the last 14 days.
- The vehicle must be in PARK or at a standstill.
- The vehicle's security system has been armed and not triggered since the last vehicle start.
- The doors, hood, and trunk/liftgate are closed.
- The vehicle's check engine light must be off.
- The vehicle must have at least a quarter tank of fuel, along with oil and battery power.
- The vehicle's hazard lights must be off.
- If equipped, the vehicle must have an automatic transmission.
- The vehicle must be in an open area with cell tower reception.
- Your mobile device must have a cellular or Wi-Fi connection.
- If the Panic button has been pressed, the vehicle must be started at least once after alarming the system.

### NOTE:

The SiriusXM Guardian™ Customer Care agents are not authorized for Remote Vehicle Start services. Contact the Uconnect Care Team for assistance.

## Remote Horn & Lights

### Description

It is easy to locate a vehicle in a dark, crowded or noisy parking area by activating the horn and lights. It may also help if you need to draw attention to your vehicle for any reason.

If you want, you can set up push notifications every time a command is sent to turn on the horn and lights.

### Working Vehicle Conditions

- The vehicle must be in PARK or at a standstill.
- The vehicle must be in an open area with cell tower reception.
- Your mobile device must have a cellular or Wi-Fi connection.

### NOTE:

The Remote Horn & Lights feature is designed to be loud and get noticed. Please keep in mind the surroundings when using this feature. You are responsible for compliance with local laws, rules and ordinances in the location of your vehicle when using Remote Horn & Lights.

## Assist — If Equipped

### Description

Vehicles equipped with the SiriusXM Guardian™ connected services feature may contain an ASSIST button in the vehicle. Once your SiriusXM Guardian™

connected services have been activated, the ASSIST button can connect you directly to the Customer Care call center (if equipped). You will be directed to one of the following four services:

- **Roadside Assistance** — If you get a flat tire or need a tow, you'll be connected to someone who can help anytime.
- **Connected Services** — Contact the SiriusXM Guardian™ Customer Care call center to activate your services, renew after your trial has expired, for in-vehicle support for your SiriusXM Guardian™ connected services, or help answering any general questions surrounding your connected services.
- **Uconnect Care** — In-vehicle support for all non-connected Uconnect system features, such as radio and Bluetooth® connections.
- **Vehicle Care** — Total support for your vehicle.

### SiriusXM Guardian™ In-Vehicle Assistance Features — If Equipped

With SiriusXM Guardian™, your vehicle has onboard assistance features located on the rearview mirror or overhead console designed to enhance your driving experience if you should ever need assistance or support.

### How It Works

Simply push the ASSIST button in the vehicle and you will be presented with your ASSIST options on

the touchscreen. Make your selection by pressing the touchscreen.

### Requirements

- This feature is available only on vehicles sold in the US and Canada.
- Vehicle must be properly equipped with the SiriusXM Guardian™ connected services.
- Vehicle must have an operable LTE (voice/data) or 3G or 4G (data) network connection.
- Vehicle must be registered with SiriusXM Guardian™ and have an active subscription that includes the applicable feature.
- Vehicle must be powered in the ON/RUN or ACC (Accessory) position with a properly functioning electrical system.

### Disclaimers

If Roadside Assistance Call is provided to your vehicle, you agree to be responsible for any additional roadside assistance service costs that you may incur. In order to provide SiriusXM Guardian™ connected services to you, we may record and monitor your conversations with Roadside Assistance Call, Vehicle Care, Uconnect Care, or SiriusXM Guardian™ Customer Care, whether such conversations are initiated through the SiriusXM Guardian™ connected services in your vehicle, or via a landline or mobile device, and may share information obtained through such recording and monitoring in accordance with



regulatory requirements. You acknowledge, agree and consent to any recording, monitoring or sharing of information obtained through any such call recordings.

## Send & Go — If Equipped

### Description

The Send & Go feature allows you to search for a destination on your mobile device, and then send the route to your vehicle's Navigation system.

### How It Works

1. There are multiple ways to find a destination. After selecting the Location tab at the bottom of the App, browse through one of the categories provided, or type the name or keyword in the search box. You can also select categories such as "Favorites" or "Contact List".
2. Select your destination from the list that appears. Location information will then be displayed on the map.

From this screen, you will be able to:

- View the location on a map.
  - See the distance from your current location.
  - Send the destination to the vehicle (Send & Go).
3. Send the destination to the Uconnect Navigation in your vehicle. You can also call the destination by pressing the Call button.

4. Confirm your destination in the vehicle through a notification or in the Navigation system.

### Requirements

- Vehicle must have an operable LTE (voice/data) or 3G or 4G (data) network connection compatible with your device.
- Vehicle must have an active subscription that includes the applicable feature.

## Vehicle Finder

### Description

The Vehicle Finder feature allows you to find the location of your vehicle.

You can also sound the horn and flash the lights to make finding your vehicle even easier.

### How It Works

Select the Vehicle Finder function within the Mobile App and select the Location tab at the bottom of the App. Then, press the Vehicle icon to find your vehicle.

### Requirements

- Vehicle must be properly equipped with the Uconnect system.
- Vehicle must have an operable LTE (voice/data) or 3G or 4G (data) network connection compatible with your device.
- Vehicle must have an active subscription that includes the applicable feature.

- Vehicle ignition must have been turned on within 14 days.

## 4G Wi-Fi Hotspot — If Equipped

### Description

4G Wi-Fi Hotspot is an in-vehicle service that connects your device to an LTE (voice/data) or 4G (data) network that is ready to go wherever you are. After you've made your purchase, turn on your device's Wi-Fi and connect your devices.

- Enables all your passengers to be simultaneously connected to the web.
- Connect several devices at one time.
- Any Wi-Fi-enabled device — such as a laptop or any other portable-enabled media — can connect over your private in-vehicle network.
- A high-speed, secured connection lets anyone on your private network access the Web — great for working and relaxing.

### WARNING!

The driver should NEVER use the 4G Wi-Fi Hotspot while driving the vehicle as doing so may result in an accident involving serious injury or death.

## Create A 4G Wi-Fi Hotspot For Use In Your Vehicle

### How It Works



The 4G Wi-Fi Hotspot feature provides the vehicle passengers with an internet access hotspot in the vehicle, using the radio as an access point. The hotspot will allow Wi-Fi-enabled in-vehicle devices (such as a laptop or any other portable-enabled media device) to wirelessly connect to the internet. Uconnect offers a complimentary 3-month trial period that includes 1GB of total data. The trial can be activated any time within the first year of new vehicle ownership.

Use one of these three ways to purchase a subscription to the 4G Wi-Fi Hotspot:

1. From your vehicle's touchscreen, select the 4G Wi-Fi Hotspot App, and press the How To Purchase button and follow the instructions.
2. Log onto your Owner's Site and click the link to the AT&T portal to get set up.
3. **For existing Connected Car customers:** Push the ASSIST button to be routed to an AT&T Customer Care agent who will assist you.

Once the 4G Wi-Fi Hotspot is purchased, you can change its name and the password by selecting the Wi-Fi Hotspot App and pressing the Setup Wi-Fi Hotspot button. You can also view the connected

devices from the app screen by pressing the View Connected Devices button.

### NOTE:

A SiriusXM Guardian™ subscription is not required in order to purchase and use the 4G Wi-Fi Hotspot.

### WARNING!

Always drive safely with your hands on the steering wheel and obey all applicable laws. You have full responsibility and assume all risks related to the use of the features and applications in this vehicle. Only use the features and applications in this vehicle when it is safe to do so. Failure to comply may result in an accident involving in serious injury or death.

## Stolen Vehicle Assistance — If Equipped

### Description

If your vehicle is stolen, the SiriusXM Guardian™ Customer Care agent may be able to locate the stolen vehicle and work with law enforcement to help recover it.

### How It Works

1. If your vehicle is stolen, contact local law enforcement as soon as possible. They will work with you to file a stolen vehicle report.
2. Next, inform SiriusXM Guardian™ Customer Care that your vehicle has been stolen.

The SiriusXM Guardian™ Customer Care Agent will ask for the stolen vehicle report number (as issued by your local law enforcement). If you have downloaded the Mobile App, you can push the Settings menu button on your device, select "Help", and then select "SiriusXM Guardian™ Customer Care" to make the call.

3. SiriusXM Guardian™ Customer Care will authenticate that you are the owner of the vehicle and contact the law enforcement with whom you filed the stolen vehicle report.
4. SiriusXM Guardian™ Customer Care will work with your local law enforcement to locate the vehicle. You will be contacted by law enforcement if your vehicle is recovered. While the investigation is ongoing, you should also contact your insurance company to inform it of the situation.

### Requirements

- Vehicle must be properly equipped with the Uconnect system.
- Vehicle must have an operable LTE (voice/data) or 3G or 4G (data) network connection compatible with your device.
- Vehicle must be registered with SiriusXM Guardian™ and have an active subscription that includes the applicable feature.

**NOTE:**

Not all features of SiriusXM Guardian™ are available everywhere at all times, particularly in remote or enclosed areas.

## Monthly Vehicle Health Report — If Equipped

### Description

Monthly Vehicle Health Report is a Uconnect service through which a summary of the performance of your vehicle's key systems will be sent to you every month so you can stay on top of your vehicle's maintenance needs. This is provided as a convenience to you and does not substitute for regular maintenance to your vehicle.

In order to provide the Monthly Vehicle Health Report, the Uconnect system in your vehicle may collect and transmit vehicle data to SiriusXM Guardian™ and to FCA, such as your vehicle's health and performance, your vehicle's location, your utilization of the features in your vehicle, and other data.

This data collection and transmission begins when you enroll in SiriusXM Guardian™ and will continue even if you cancel your SiriusXM Guardian™ subscription unless you call SiriusXM Guardian™ Customer Care and tell them to deactivate your Uconnect Services.

Please see the Uconnect Privacy Policy for more information, located at [www.driveuconnect.com/connectedservices/privacy.html](http://www.driveuconnect.com/connectedservices/privacy.html) (US Residents) or [www.driveuconnect.ca](http://www.driveuconnect.ca) (Canadian Residents).

For more information on SiriusXM Guardian™ private policy, see <https://siriusxmcvs.com/privacy-policy>.

## Vehicle Health Alert —If Equipped

### Description

Your vehicle will send you an email alert if it senses a problem with one of your vehicle's key systems. For further information, go to your Owner's website.

**NOTE:**

Vehicle Health Alert emails require you to register and activate services. During this process you will be asked to provide an email address to which the reports will be sent.

## In-Vehicle Notifications — If Equipped

### Description

Your vehicle will send you notifications to remind you when services are needed, or to alert you of other important information, such as recall notices. When you receive a notification through your touchscreen, press OK to dismiss the message, or press Call Care to speak with a SiriusXM Guardian™ Customer Care agent.

**NOTE:**

Pressing "OK" or the X button on the pop-up screen will dismiss or close the pop-up, and the In-Vehicle Messages mailbox will display. In the Mailbox, you can reopen messages or delete messages.

## Amazon Alexa Skill — If Equipped

Enjoy the convenience of using your voice to command your vehicle with Amazon Alexa!

With Amazon Alexa, you can connect to your vehicle and remotely access key services and features.

If your vehicle is equipped with Uconnect Navigation, you can send a destination directly to your vehicle using Alexa.

If you need assistance, you can always ask Alexa for help, or complete a list of commands by saying: "Alexa, ask <brand name> for help with my car."

Here are a few of the many questions you can ask Alexa:

- "Alexa, ask <vehicle brand> to start my <vehicle name> with your Voice Code ."
- "Alexa, ask <vehicle brand> to lock my <vehicle name> with your Voice Code."
- "Alexa, ask <vehicle brand> to send 1000 Chrysler Drive, Auburn Hills, Michigan to my <vehicle name>."
- "Alexa, ask <vehicle brand> what is the fuel level of my <vehicle name>."

An active subscription to SiriusXM Guardian™ is required. To use Amazon Alexa, first, register for SiriusXM Guardian™ ↗ page 255.

Next, link the Uconnect system on your vehicle to Amazon Alexa:

1. Download the Amazon Alexa app on your mobile device (Apple® or Android™).
2. Once in the app, tap MENU and go to SKILLS.
3. Search for <vehicle brand> skill, then tap Enable.
4. Tap SAVE SETTINGS when prompted.
5. Link the vehicle brand name to the <vehicle brand> Skill by tapping LINK ACCOUNT.
6. Log in using your Owner Account credentials. This will be the same user name and password you used when registering for SiriusXM Guardian™ connected services. There will be additional settings to confirm on the following screen.
7. AUTHORIZE the account to return to the <vehicle brand> Skill.

You can now begin using the <vehicle brand> Skill on Alexa!

### Google Assistant — If Equipped

With the Google Assistant, you can get help and keep tabs on your car. Google Assistant is available across your devices, including Android™ phones, iPhone® devices, or voice-activated speakers, like

Google Home. If you need assistance, ask Google for help, or for a complete list of commands by saying: “Hey Google, ask <brand name> for help with my car.”

Here are a few examples of commands:

- “Hey Google, ask <vehicle brand> to start my <vehicle name> with your Voice Code.”
- “Hey Google, ask <vehicle brand> to lock my <vehicle name> with your Voice Code.”
- “Hey Google, ask <vehicle brand> to send 1000 Chrysler Drive, Auburn Hills, Michigan to my <vehicle name>.”
- “Hey Google, ask <vehicle brand> what is the fuel level of my <vehicle name>.”

To link your Uconnect account with Google Assistant, follow these steps:

1. Download and install the Google Assistant app on your smart phone from the App Store® or Google Play.
2. After installation, log in to the Google Assistant app with your Gmail ID. Verify your account by pressing the icon in the upper right-hand corner.
3. Press the Discover button in the bottom left corner of the screen. Enter the vehicle brand name.
4. A prompt will appear to link your Uconnect account. Press “Link Uconnect to Google”.

5. Press “Sign In” and enter the email address and password you created when you activated SiriusXM Guardian™. There will be additional settings to confirm on the following screen.
6. Lastly, press “Authorize” to complete the linking process.

Now, you can ask Google Assistant to help you:

- Remotely start the engine, or cancel a remote start
- Send a destination to your vehicle’s built-in Uconnect Navigation system
- Monitor vehicle vitals, such as tire pressure, fuel level and oil life
- And more!

### Family Drive Alerts — If Equipped

#### Description

Family Drive Alerts help promote safer driving and give you peace of mind when your loved ones are out on the road. You can set boundary limits, monitor driving speed, and pinpoint your vehicle’s location any time, any place. Use the Mobile App to set alerts:

#### ● Boundary Alert

Receive a notification the moment your vehicle is driven either out of or into a geographic boundary that you set.

### ● Curfew Alert

Receive a notification when your car is being driven outside of the curfew time.

### ● Speed Alert

Receive a notification whenever your car exceeds a speed limit you set.

### ● Valet Alert

Receive a notification if and when your vehicle is driven outside a quarter-mile radius of a valet drop-off zone.

## SmartWatch Integration — If Equipped

### Description

SmartWatch Integration puts the Mobile App right on your Apple® Watch or Android™ Wear. To get started, follow these steps:

1. Download the Mobile App from the App Store® or Google Play.
2. Log onto the app from your smartphone using the username and password you created when you first set up your account.
3. Make sure your watch and smartphone are connected through Bluetooth®.
4. The Mobile App should appear on your SmartWatch.

Once the app is downloaded on your SmartWatch, you can enjoy these features:

- Lock or unlock your vehicle by tapping the remote lock button in the app and entering your security PIN.
- Remote start or stop your vehicle.
- View important vehicle stats, such as fuel level, vehicle location, tire pressure warning, and more.

For help, refer to the Uconnect YouTube channel for SmartWatch Integration.

## MANAGE MY SIRIUSXM GUARDIAN™ ACCOUNT

To manage your SiriusXM Guardian™ account, press the ASSIST button in your vehicle, or call SiriusXM Guardian™ Customer Care.

### NOTE:

It is recommended, when selling your vehicle, or turning in your lease, to call SiriusXM Guardian™ Care to remove your personal data.

## CONNECTED SERVICES FAQs

For additional information about SiriusXM Guardian™, active subscribers can push the ASSIST button (if equipped) and then select SiriusXM Guardian™ Call on your in-vehicle touchscreen to contact SiriusXM Guardian™. Your call will be directed to a SiriusXM Guardian™ agent or held in a queue until an agent is available. If you do not have an active subscription, push the

ASSIST button and press the Activate button on the touchscreen to activate services.

## CONNECTED SERVICES SOS FAQs — IF EQUIPPED

1. **What happens if I accidentally push the SOS Call button on the mirror or overhead console?** You have 10 seconds after pushing the SOS Call button to cancel the call. To cancel the call, either push the SOS Call button again, or press the Cancel button on the in-vehicle touchscreen.
2. **What type of information is sent when I use the SOS Call button from my vehicle?** Certain vehicle information, such as make and model, is transmitted along with the last known GPS location.
3. **When could I use the SOS Call button?** You can use the SOS Call button to make a call if you or someone else needs emergency assistance.

## CONNECTED SERVICES REMOTE DOOR LOCK/UNLOCK FAQs

1. **How long does it take to unlock or lock the door?** Depending on various conditions, it can take up to three minutes or more for the request to get to your vehicle.
2. **Which is faster, my key fob or the Mobile App?** Your key fob will lock/unlock the door more

quickly, however its range is limited and your Mobile App comes in handy for these and other situations.

3. **Will my vehicle be safe if I lose my device?** People sometimes lose their mobile devices, which is why security measures have been engineered into the Mobile App. Asking for your username, password and SiriusXM Guardian™ Security PIN are required for the activation of Remote services through your mobile device. It is your responsibility to protect your passwords and PINs.
4. **Why can't all mobile devices use the Mobile App?** The Mobile App is compatible with most devices with the Apple® and Android™ operating systems. The capabilities of these devices allow us to remotely command your vehicle. Other operating systems may be supported in the future.
5. **Why is the Mobile App running slow?** The Mobile App relies on a mobile network connection from your device to send commands to your vehicle which must have an operable LTE (voice/data) or 3G, 4G (data), or 5G (data) network connection. If either your device or your vehicle is in an area with below average coverage, it may take longer to log in and send commands.

## CONNECTED SERVICES ROADSIDE ASSISTANCE FAQs

1. **What is the phone number for roadside assistance call?** The phone number is:
  - US: 1-800-521-2779
  - Canada: 1-800-363-4869
2. **If I am subscribed to SiriusXM Guardian™, does it cover towing or other expenses incurred by using roadside assistance?** No, however your new vehicle may include Roadside Assistance Call services.

## CONNECTED SERVICES SEND & GO FAQs — IF EQUIPPED

1. **How long does it take to send the route and destination to my vehicle?** Depending on various conditions, it can take up to three minutes for the request to get through to your vehicle.
2. **Can I cancel a route I sent to my vehicle?** Yes, once you enter your vehicle, and start the engine, the pop-up message stating that you have a new route will appear. There is an exit button on the pop-up that will cancel the route if selected.

3. **Can I select a different route than the most recent one I sent to my vehicle?** Yes, once you enter the vehicle, and start the engine, the pop-up message offers a “Locations” option. Once “Locations” is selected, you can choose from a list of recently sent destinations.

## CONNECTED SERVICES VEHICLE FINDER FAQs

1. **Can someone else locate my vehicle?** Your vehicle may be located by anyone who has your PIN and access to your account. It is your responsibility to guard your PIN accordingly. See the Uconnect and SiriusXM Guardian™ terms of service for more information.
2. **How long does it take to sound my horn and flash the lights?** Depending on various conditions, it can take three minutes or more for the request to get through to your vehicle.
3. **How do I turn off the horn and lights after I turn them on?** If you are close enough to the vehicle, you can use the key fob to turn off the horn and lights by pushing the red Panic button.

## CONNECTED SERVICES STOLEN VEHICLE ASSISTANCE FAQs — IF EQUIPPED

1. **Can someone locate my vehicle?** To enhance your privacy, and the privacy of others using your vehicle, a stolen vehicle police report is required for you to activate this service. You must involve local law enforcement to have SiriusXM Guardian™ locate your vehicle. We may also locate the vehicle for other law enforcement or government agencies, subject to a valid court order telling SiriusXM Guardian™ to do so. We will also provide the service for FCA entities to locate a vehicle that you have purchased through them.
2. **How will I know if my vehicle is recovered?** After you provide the SiriusXM Guardian™ Customer Care agent with the stolen vehicle report, the agent will work together with law enforcement to try to locate your vehicle. If your vehicle is recovered, you will be contacted by law enforcement.
3. **Can SiriusXM Guardian™ lower my insurance rates?** Some insurance providers offer lower rates on vehicles equipped with systems that can deter auto theft. When shopping for insurance, be sure to inform the insurance provider of your SiriusXM Guardian™ connected services subscription to find out if the insurance provider can offer you a lower rate.

### NOTE:

Neither FCA nor SiriusXM® are insurance companies, and SiriusXM Guardian™ is not an insurance product. You are responsible for obtaining insurance coverage for your vehicle and yourself.

## CONNECTED SERVICES REMOTE VEHICLE START FAQs

1. **How long does it take to remotely start my vehicle?** Depending on various conditions, it can take three minutes or more for the request to get through to your vehicle.
2. **Which is faster, my key fob or the Mobile App?** Your key fob will remote start your vehicle more quickly. However its range is limited. For example, when you are leaving the stadium after the game, you can use the Mobile App to remote start your vehicle and have the inside of your vehicle comfortable by the time you get to it.
3. **Will my vehicle be safe if I lose my wireless device?** People sometimes lose their wireless devices, which is why security measures have been engineered into the Mobile App. Asking for your username, password and SiriusXM Guardian™ Security PIN help to ensure that nobody can start your vehicle if they happen to find your device.

4. **Can someone drive off with my vehicle using the App?** No. Driving your vehicle still requires the keys to be in the vehicle. The Remote Start feature simply starts the engine to warm up or cool down the interior before you arrive.
5. **Can I stop a vehicle that is being driven with the cancel Remote Vehicle Start command?** No. If the vehicle is in motion, the cancel Remote Vehicle Start button will not stop the vehicle.
6. **Why can't all mobile devices use the Mobile App?** The Mobile App has been designed to work on most devices with the Apple® and Android™ operating systems. The capabilities of these devices allow us to remotely command your vehicle. Other operating systems may be supported in the future.

## CONNECTED SERVICES REMOTE HORN & LIGHTS FAQs

1. **How long does it take to sound my horn and flash the lights?** Depending on various conditions, it can take three minutes or more for the request to get through to your vehicle.
2. **Which is faster, my key fob or the Mobile App?** Your key fob will sound the horn and flash the lights quicker; however, its range is limited.
3. **How do I turn off the horn and lights after I turn them on?** If you are close enough to the

vehicle, you can use the key fob to turn off the horn and lights by pressing the red Panic button. Otherwise, Remote Horn & Lights will continue for a maximum of three minutes.

4. **Why can't all mobile devices use the Mobile App?** The Mobile App has been designed to work on most devices with the Apple® and Android™ operating systems. The capabilities of these devices allow us to remotely command your vehicle. Other operating systems may be supported in the future.

## CONNECTED SERVICES ACCOUNT FAQs — IF EQUIPPED

1. **How do I register for my SiriusXM Guardian™ account?** There are three ways that you can register your SiriusXM Guardian™ Account:
  - Push the ASSIST button. A call will be placed to an agent who can assist in registering your new account.
  - Press the Activate Services icon in the Apps menu. Select the button to speak with an agent, who can assist in registering your new account.
  - Press the Activate Services icon in the Apps menu. Enter your email on the touchscreen and then follow the prompts from the provided email. You will receive an email with an activation link that will be good for
2. **Why do I need an email address?** Without an email address, customers cannot register for SiriusXM Guardian™. Customers need to register so they can subscribe to receive additional services and create a SiriusXM Guardian™ Security PIN for remote command requests.
3. **How do I create a SiriusXM Guardian™ security PIN?** Set up your SiriusXM Guardian™ Security PIN during the registration process. The SiriusXM Guardian™ Security PIN will be required to authenticate you when accessing your account via SiriusXM Guardian™ Call or performing any remote services, such as Remote Door Lock/Unlock, Remote Horn & Lights, or Remote Vehicle Start.
4. **What if I forgot my SiriusXM Guardian™ security PIN?** If you've already activated services and forgot your SiriusXM Guardian™ Security PIN, you can reset the PIN by selecting Edit Profile on your Owner's Site.
5. **How do I update my SiriusXM Guardian™ payment account address?** Your SiriusXM Guardian™ Payment Account address can be updated online, or by calling SiriusXM Guardian™ Customer Care from ASSIST in your vehicle. To update online: login to your Owner's Site, and select Edit Profile > SiriusXM Guardian™ Payment Account.
6. **How do I update my SiriusXM Guardian™ profile?** Your name, home address, phone number, email address and SiriusXM Guardian™ Security PIN can be updated online on your Owner's Site. Log in to your Owner's Site then select Edit Profile to edit your personal information. Make your edits and click Save.
7. **Can I try features or packages before I buy them?** Your new vehicle purchase may have come with an included trial period for certain Apps and services.
8. **Can I access every App and service while driving?** No, some applications and services are not available while driving. For your own safety, it is not possible to use some of the touchscreen features while the vehicle is in motion (e.g. key pad).
9. **What happens when my subscription comes up for renewal?** If you have added a credit card to your account information, your subscription will be automatically renewed for a term length in accordance with the service plan that you have selected at the then current subscription rate and on every renewal date thereafter,



unless you cancel your subscription by calling SiriusXM Guardian™ Care. If you have not added a credit card to your account, SiriusXM Guardian™ will send you an email or letter in advance of your expiration date to remind you that your subscription is ending soon.

10. **How do I manage my SiriusXM Guardian™ notification preferences?** Contact SiriusXM Guardian™ Customer Care, or go to your Owner's Site and then update your preferences on the SiriusXM Guardian™ customer web portal.
11. **How do I purchase a subscription?** Contact SiriusXM Guardian™ Customer Care by pushing the ASSIST button on your rearview mirror or overhead console.
12. **How do I update my credit card information?** Login to your Owner's Site, and select Edit Profile, then select SiriusXM Guardian™ Payment Account.
13. **How do I find out how much longer I have on my subscription?** Contact SiriusXM Guardian™ Customer Care.

You also can visit your Owner's Site and choose a subscription to view its expiration date. When your subscription is about to expire, you will receive an email or letter of notification.

14. **Can I get a refund if I have not used the entire subscription?** Prorated refunds are provided from the date of cancellation for annual plans or longer. Please see the Uconnect and SiriusXM Guardian™ Terms & Conditions for refunds related to billing plans of other lengths and other circumstances.
15. **Can I cancel a subscription before it expires?** Yes. If you have an annual subscription, your subscription will be canceled the day you cancel. If you have a monthly subscription, your subscription will be canceled on the last day of the month in which you choose to cancel.
16. **What should I do if I want to sell my vehicle?** Before your vehicle is sold to a new owner, you'll want to remove your account information. This process removes all personal information, returns the Uconnect system to its original factory settings, removes all SiriusXM Guardian™ connected services and account information. To remove your account information from the Uconnect system, contact SiriusXM Guardian™ Customer Care.
17. **What if I forgot to remove my account information before I returned my lease vehicle or sold it?** Contact SiriusXM Guardian™ Customer Care.

18. **What will happen if an operable LTE (voice/data), 4G (data), or 5G (data) network connection compatible with my device is temporarily unavailable?** The SOS Call and ASSIST buttons will NOT function if you are not connected to an operable LTE (voice/data) or 3G, 4G (data), 5G (data) network. Services that required your smartphone only direct calls to Roadside Assistance Call may be functioning if you have an operable network.

## DATA COLLECTION & PRIVACY

The Uconnect system collects and transmits data which may include information about your vehicle, your vehicle's health and performance, your vehicle's location, your utilization of the features in your vehicle, and other data. The collection, use and sharing of this information is required to provide the SiriusXM Guardian™ connected services and is further described by the Uconnect Privacy Policy, which can be found at [www.driveuconnect.com/connectedservices/privacy.html](http://www.driveuconnect.com/connectedservices/privacy.html) (US Residents) or [www.driveuconnect.ca](http://www.driveuconnect.ca) (Canadian Residents). This information may be collected by SiriusXM® Connected Vehicle Services Inc. and shared with FCA US LLC for the purposes stated in the Uconnect Privacy Policy. Vehicle health and

diagnostic information including location data may be used by Uconnect to provide a Vehicle Health Report to you.

**Even if you cancel your SiriusXM Guardian™ subscription, this vehicle diagnostic health information, including location data, may still be transmitted from your vehicle and you may still have a Vehicle Health Report sent to you.**

Use of any of the connected services including SiriusXM Guardian™ is deemed to be your consent to the collection, use and disclosure of this information in accordance with the Uconnect Privacy Policy. If you do not want this information to be collected, used, or shared, you must cancel your Uconnect services in their entirety by contacting us as referenced in the Uconnect Privacy Policy.

## RADIO OPERATION AND MOBILE PHONES

Under certain conditions, the mobile phone being on in your vehicle can cause erratic or noisy performance from your radio. This condition may be lessened or eliminated by repositioning the mobile phone within the vehicle. This condition is not harmful to the radio. If your radio performance does not satisfactorily improve from repositioning the mobile phone, it is recommended that the volume be turned down or off during mobile phone operation when not using the Uconnect system.

## REGULATORY AND SAFETY INFORMATION

### US/CANADA

Exposure to Radio Frequency Radiation

The radiated output power of the internal wireless radio is far below the FCC and IC radio frequency exposure limits. Nevertheless, the wireless radio will be used in such a manner that the radio is 8 in (20 cm) or further from the human body.

The internal wireless radio operates within guidelines found in radio frequency safety standards and recommendations, which reflect the consensus of the scientific community.

The radio manufacturer believes the internal wireless radio is safe for use by consumers. The level of energy emitted is far less than the electromagnetic energy emitted by wireless devices such as mobile phones. However, the use of wireless radios may be restricted in some situations or environments, such as aboard airplanes. If you are unsure of restrictions, you are encouraged to ask for authorization before turning on the wireless radio → page 431.

## OFF-ROAD PAGES — IF EQUIPPED

If your vehicle is equipped with Off-Road Pages, it will provide you vehicle status information while operating on off-road conditions. It supplies information relating to the status of the drivetrain, transfer case, coolant/oil gauges, pitch and roll of the vehicle and access to the trailcam system.

To access Off-Road Pages, press the Apps button on the touchscreen, and then select “Off-Road Pages”.



**Main Menu**

- 1 — Mobile Apps Button
- 2 — Off-Road Pages App

## OFF-ROAD PAGES STATUS BAR

The Off-Road Pages Status Bar is located along the bottom of Off-Road Pages and is present in each of the three selectable page options. It provides continually updating information for the following items:

- Current Transfer Case Status
- Current Latitude/Longitude
- Current Altitude of the vehicle
- Status of Hill Descent/Selec-Speed Control and Selected Speed in MPH (km/h)
- Status of Off-Road+ Mode



Status Bar 2WD/4WD

- 1 – Transfer Case Status
- 2 – Current Latitude/Longitude
- 3 – Current Altitude
- 4 – Hill Descent Control

## DRIVETRAIN

The Drivetrain page displays information concerning the vehicle's drivetrain.

The following information is displayed:

- Steering angle in degrees
- Status of Transfer Case
- Status of the Rear Axles – If Equipped

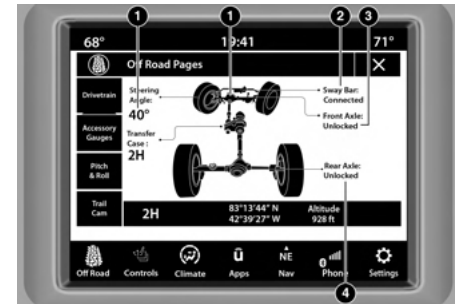

Drivetrain Menu 2WD/4WD

- 1 – Steering Angle
- 2 – Sway Bar
- 3 – Front Axle Locker Status
- 4 – Rear Axle Locker Status

## ACCESSORY GAUGE

The Accessory Gauge page displays the current status of the vehicle's Coolant Temperature, Oil Temperature, Oil Pressure (Gas Vehicles Only), Transmission Temperature, and Battery Voltage.



Accessory Gauges Menu 2WD/4WD

- 1 – Coolant Temperature
- 2 – Oil Temperature
- 3 – Oil Pressure (Gas Vehicles Only)
- 4 – Transmission Temperature  
(Automatic Transmissions Only)
- 5 – Battery Voltage

## PITCH & ROLL

The Pitch & Roll page displays the vehicle's current pitch (angle up and down) and roll (angle side to side) in degrees. The Pitch & Roll gauges provide a visualization of the current vehicle angle.



Pitch & Roll Menu 2WD/4WD

- 1 – Current Pitch
- 2 – Current Roll

## TRAILCAM — IF EQUIPPED

Your vehicle may be equipped with a TrailCam that allows you to see an on-screen image of the front view of your vehicle. The image will be displayed on the touchscreen along with a caution note “Check Entire Surroundings” across the top of the screen.

To activate, press the TrailCam button on the touchscreen.



TrailCam Activation

# SAFETY

## SAFETY FEATURES

### ANTI-LOCK BRAKE SYSTEM (ABS)

The ABS provides increased vehicle stability and brake performance under most braking conditions. The system automatically prevents wheel lock and enhances vehicle control during braking.

The ABS performs a self-check cycle to ensure that the ABS is working properly each time the vehicle is started and driven. During this self-check, you may hear a slight clicking sound as well as some related motor noises.

The ABS is activated during braking when the system detects one or more wheels are beginning to lock. Road conditions such as ice, snow, gravel, bumps, railroad tracks, loose debris, or panic stops may increase the likelihood of ABS activation(s).

You also may experience the following normal characteristics when the ABS activates:

- ABS motor noise or clicking sounds (you may continue to hear for a short time after the stop)
- Brake pedal pulsations
- A slight drop of the brake pedal at the end of the stop

The ABS is designed to function with the Original Equipment Manufacturer (OEM) tires. Modification may result in degraded ABS performance.

#### WARNING!

- The ABS contains sophisticated electronic equipment that may be susceptible to interference caused by improperly installed or high output radio transmitting equipment. This interference can cause possible loss of anti-lock braking capability. Installation of such equipment should be performed by qualified professionals.
- Pumping of the Anti-Lock Brakes will diminish their effectiveness and may lead to a collision. Pumping makes the stopping distance longer. Just press firmly on your brake pedal when you need to slow down or stop.
- The ABS cannot prevent the natural laws of physics from acting on the vehicle, nor can it increase braking or steering efficiency beyond that afforded by the condition of the vehicle brakes and tires or the traction afforded.

*(Continued)*

#### WARNING!

- The ABS cannot prevent collisions, including those resulting from excessive speed in turns, following another vehicle too closely, or hydroplaning.
- The capabilities of an ABS equipped vehicle must never be exploited in a reckless or dangerous manner that could jeopardize the user's safety or the safety of others.

### Anti-Lock Brake System (ABS) Warning Light

The yellow ABS Warning Light will turn on when the ignition is placed in the ON/RUN mode and may stay on for as long as four seconds.

If the ABS Warning Light remains on or comes on while driving, it indicates that the anti-lock portion of the brake system is not functioning and that service is required. However, the conventional brake system will continue to operate normally if the ABS Warning Light is on.

If the ABS Warning Light is on, the brake system should be serviced as soon as possible to restore the benefits of Anti-Lock Brakes. If the ABS Warning Light does not come on when the ignition is placed in the ON/RUN mode, have the light repaired as soon as possible.

## **ELECTRONIC BRAKE CONTROL (EBC) SYSTEM**

**If applicable, refer to the “Hybrid Supplement” for additional information.**

Your vehicle is equipped with an advanced Electronic Brake Control (EBC) system. This system includes Anti-Lock Brake System (ABS), Brake Assist System (BAS), Electronic Brake Force Distribution (EBD), Electronic Roll Mitigation (ERM), Electronic Stability Control (ESC), Hill Start Assist (HSA), and Traction Control System (TCS). These systems work together to enhance both vehicle stability and control in various driving conditions.

Your vehicle may also be equipped with Hill Descent Control (HDC), Rain Brake Support (RBS), Ready Alert Braking (RAB), and Trailer Sway Control (TSC).

### **Brake System Warning Light**

The red Brake System Warning Light will turn on when the ignition is placed in the ON/RUN mode and may stay on for as long as four seconds.

If the Brake System Warning Light remains on or comes on while driving, it indicates that the brake system is not functioning properly and that immediate service is required. If the Brake System Warning Light does not come on when the ignition is placed in the ON/RUN mode, have the light repaired as soon as possible.

### **Brake Assist System (BAS)**

The BAS is designed to optimize the vehicle's braking capability during emergency braking maneuvers. The system detects an emergency braking situation by sensing the rate and amount of brake application and then applies optimum pressure to the brakes. This can help reduce braking distances. The BAS complements the Anti-Lock Brake System (ABS). Applying the brakes very quickly results in the best BAS assistance. To receive the benefit of the system, you must apply continuous braking pressure during the stopping sequence (do not “pump” the brakes). Do not reduce brake pedal pressure unless braking is no longer desired. Once the brake pedal is released, the BAS is deactivated.

### **WARNING!**

The Brake Assist System (BAS) cannot prevent the natural laws of physics from acting on the vehicle, nor can it increase the traction afforded by prevailing road conditions. BAS cannot prevent collisions, including those resulting from excessive speed in turns, driving on very slippery surfaces, or hydroplaning. The capabilities of a BAS-equipped vehicle must never be exploited in a reckless or dangerous manner, which could jeopardize the user's safety or the safety of others.

### **Electronic Brake Force Distribution (EBD)**

EBD manages the distribution of the braking torque between the front and rear axles by limiting braking pressure to the rear axle. This is done to prevent overslip of the rear wheels to avoid vehicle instability, and to prevent the rear axle from entering ABS before the front axle.

### **Electronic Roll Mitigation (ERM)**

ERM anticipates the potential for wheel lift by monitoring the driver's steering wheel input and the speed of the vehicle. When ERM determines that the rate of change of the steering wheel angle and vehicle's speed are sufficient to potentially cause wheel lift, it then applies the appropriate brake and may also reduce engine power to lessen

the chance that wheel lift will occur. ERM can only reduce the chance of wheel lift occurring during severe or evasive driving maneuvers; it cannot prevent wheel lift due to other factors, such as road conditions, leaving the roadway, or striking objects or other vehicles.

#### NOTE:

ERM is disabled any time the ESC is in "Full Off" mode (if equipped) → page 277.

#### WARNING!

Many factors, such as vehicle loading, road conditions and driving conditions, influence the chance that wheel lift or rollover may occur. ERM cannot prevent all wheel lift or rollovers, especially those that involve leaving the roadway or striking objects or other vehicles. The capabilities of an ERM-equipped vehicle must never be exploited in a reckless or dangerous manner which could jeopardize the user's safety or the safety of others.

### Electronic Stability Control (ESC)

ESC enhances directional control and stability of the vehicle under various driving conditions. ESC corrects for oversteering or understeering of the vehicle by applying the brake of the appropriate wheel(s) to counteract the above conditions.

Engine power may also be reduced to help the vehicle maintain the desired path.

- Oversteer – when the vehicle is turning more than appropriate for the steering wheel position.
- Understeer – when the vehicle is turning less than appropriate for the steering wheel position.

ESC uses sensors in the vehicle to determine the vehicle path intended by the driver and compares it to the actual path of the vehicle. When the actual path does not match the intended path, ESC applies the brake of the appropriate wheel to assist in counteracting the oversteer or understeer condition.

The ESC Activation/Malfunction Indicator Light located in the instrument cluster will start to flash as soon as the ESC system becomes active. The ESC Activation/Malfunction Indicator Light also flashes when the TCS is active. If the ESC Activation/Malfunction Indicator Light begins to flash during acceleration, ease up on the accelerator and apply as little throttle as possible. Be sure to adapt your speed and driving to the prevailing road conditions.

#### WARNING!

- Electronic Stability Control (ESC) cannot prevent the natural laws of physics from acting on the vehicle, nor can it increase the traction afforded by prevailing road conditions. ESC cannot prevent accidents, including those resulting from excessive speed in turns, driving on very slippery surfaces, or hydroplaning. ESC also cannot prevent accidents resulting from loss of vehicle control due to inappropriate driver input for the conditions. Only a safe, attentive, and skillful driver can prevent accidents. The capabilities of an ESC equipped vehicle must never be exploited in a reckless or dangerous manner which could jeopardize the user's safety or the safety of others.
- Vehicle modifications, or failure to properly maintain your vehicle, may change the handling characteristics of your vehicle, and may negatively affect the performance of the ESC system. Changes to the steering system, suspension, braking system, tire type and size or wheel size may adversely affect ESC performance. Improperly inflated and unevenly worn tires may also degrade ESC performance. Any vehicle modification or poor vehicle maintenance that reduces the effectiveness of the ESC system can increase the risk of loss of vehicle control, vehicle rollover, personal injury and death.

## ESC Operating Modes

Depending upon model and mode of operation, the ESC system may have multiple operating modes.

### ESC On

“ESC On” is the normal operating mode for the ESC. Whenever the vehicle is started, the ESC system will be in this mode. This mode should be used for most driving conditions. Alternate ESC modes should only be used for specific reasons as noted in the following paragraphs.

### Partial Off

This mode may be useful if the vehicle becomes stuck. This mode may modify TCS and ESC thresholds for activation, which allows for more wheel spin than normally allowed.

To enter the “Partial Off” mode, momentarily push the ESC OFF button and the ESC OFF Indicator Light will illuminate. To turn the ESC on again, momentarily push the ESC OFF button and the ESC OFF Indicator Light will turn off.

### NOTE:

For vehicles with multiple partial ESC modes, the push and release of the button will toggle the ESC modes. Multiple attempts may be required to return to “ESC On”.

### WARNING!

- When in “Partial Off” mode, the TCS functionality of ESC, except for the limited slip feature described in the TCS section, has been disabled and the ESC OFF Indicator Light will be illuminated. When in “Partial Off” mode, the engine power reduction feature of TCS is disabled, and the enhanced vehicle stability offered by the ESC system is reduced.
- Trailer Sway Control (TSC) is disabled when the ESC system is in the “Partial Off” mode.

### Full Off – If Equipped

The “Full Off” mode is intended for off-highway or off-road use only and should not be used on any public roadways. In this mode, TCS and ESC features are turned off. To enter the “Full Off” mode, push and hold the ESC OFF button for five seconds while the vehicle is stopped with the engine running. After five seconds, a chime will sound, the ESC OFF Indicator Light will illuminate, and the “ESC Off” message will display in the instrument cluster. To turn ESC on again, momentarily push the ESC OFF button.

### NOTE:

System may switch from ESC “Full Off” to “Partial Off” mode when vehicle exceeds a predetermined speed. When the vehicle speed slows below the

predetermined speed the system will return to ESC “Full Off”.

If equipped with Off Road+ and if Off Road+ is active when “Full Off” mode is enabled by the driver, ESC will not switch to “Partial Off” mode at any speed and will remain in “Full Off” mode until Off Road+ is exited or ESC is re-enabled by the driver.

### WARNING!

- In the ESC “Full Off” mode, the engine torque reduction and stability features are disabled. Therefore, enhanced vehicle stability offered by the ESC system is unavailable. In an emergency evasive maneuver, the ESC system will not engage to assist in maintaining stability. ESC “Full Off” mode is intended for off-highway or off-road use only.
- The Electronic Stability Control (ESC) cannot prevent the natural laws of physics from acting on the vehicle, nor can it increase the traction afforded by prevailing road conditions. ESC cannot prevent all accidents, including those resulting from excessive speed in turns, driving on very slippery surfaces, or hydroplaning. ESC also cannot prevent collisions.



## ESC Activation/Malfunction Indicator Light And ESC OFF Indicator Light



The ESC Activation/Malfunction Indicator Light in the instrument cluster will come on when the ignition is turned to the “ESC On” mode. It should go out with the engine running. If the ESC Activation/Malfunction Indicator Light comes on continuously with the engine running, a malfunction has been detected in the ESC system. If this light remains on after several ignition cycles, and the vehicle has been driven several miles (km) at speeds greater than 30 mph (48 km/h), see an authorized dealer as soon as possible to have the problem diagnosed and corrected.

The ESC Activation/Malfunction Indicator Light starts to flash as soon as the tires lose traction and the ESC system becomes active. The ESC Activation/Malfunction Indicator Light also flashes when TCS is active. If the ESC Activation/Malfunction Indicator Light begins to flash during acceleration, ease up on the accelerator and apply as little throttle as possible. Be sure to adapt your speed and driving to the prevailing road conditions.



The ESC OFF Indicator Light indicates the customer has elected to have the Electronic Stability Control (ESC) in a reduced mode.

### NOTE:

- The ESC Activation/Malfunction Indicator Light and the ESC OFF Indicator Light come on momentarily each time the ignition is placed in the ON position.
- Each time the ignition is placed in the ON position, the ESC system will be on even if it was turned off previously.
- The ESC system will make buzzing or clicking sounds when it is active. This is normal; the sounds will stop when ESC becomes inactive following the maneuver that caused the ESC activation.

### Hill Descent Control (HDC) — If Equipped

HDC is intended for low speed off-road driving while in 4WD Low. HDC maintains vehicle speed while descending hills during various driving situations. HDC controls vehicle speed by actively controlling the brakes.

#### HDC has three states:

1. Off (feature is not enabled and will not activate).
2. Enabled (feature is enabled and ready but activation conditions are not met, or driver is actively overriding with brake or throttle application).
3. Active (feature is enabled and actively controlling vehicle speed).

### Enabling HDC

HDC is enabled by pushing the HDC switch, but the following conditions must also be met to enable HDC:

- The driveline is in 4WD Low.
- The vehicle speed is below 5 mph (8 km/h).
- The parking brake is released.
- The driver door is closed. (If doors are attached, then door must be closed. If doors are detached, then driver seat belt must be buckled.)

### Activating HDC

Once HDC is enabled it will activate automatically if driven down a grade of sufficient magnitude. The set speed for HDC is selectable by the driver, and can be adjusted by using the gear shift +/- . The following summarizes the HDC set speeds:

#### HDC Target Set Speeds

- P = No set speed. HDC may be enabled but will not activate
- R = 0.6 mph (1 km/h)
- N = 1.2 mph (2 km/h)
- D = 0.6 mph (1 km/h)
- 1st = 0.6 mph (1 km/h)
- 2nd = 1.2 mph (2 km/h)
- 3rd = 1.8 mph (3 km/h)

- 4th = 2.5 mph (4 km/h)
- 5th = 3.1 mph (5 km/h)
- 6th = 3.7 mph (6 km/h)
- 7th = 4.3 mph (7 km/h)
- 8th = 5.0 mph (8 km/h)
- 9th = 5.6 mph (9 km/h) – If Equipped

**NOTE:**

During HDC the +/- shifter input is used for HDC target speed selection, but will not affect the gear chosen by the transmission. When actively controlling HDC the transmission will shift appropriately for the driver-selected set speed and corresponding driving conditions.

**Driver Override**

The driver may override HDC activation with throttle or brake application at any time.

**Deactivating HDC**

HDC will be deactivated but remain available if any of the following conditions occur:

- Driver overrides HDC set speed with throttle or brake application.
- Vehicle speed exceeds 20 mph (32 km/h) but remains below 40 mph (64 km/h).
- Vehicle is on a downhill grade of insufficient magnitude, is on level ground, or is on an uphill grade.
- Vehicle is shifted to PARK.

**Disabling HDC**

HDC will be deactivated and disabled if any of the following conditions occur:

- The driver pushes the HDC switch.
- The driveline is shifted out of 4WD Low.
- The parking brake is applied.
- The driver door opens. (Driver door opens if doors are attached or driver seat belt is unbuckled if doors are detached.)
- The vehicle is driven greater than 20 mph (32 km/h) for greater than 70 seconds.
- The vehicle is driven greater than 40 mph (64 km/h) (HDC exits immediately).
- HDC detects excessive brake temperature.

**Feedback To The Driver**

The instrument cluster has an HDC icon and the HDC switch has an indicator light, which offers feedback to the driver about the state HDC is in.

- The cluster icon and switch indicator light will illuminate and remain on solid when HDC is enabled or activated. This is the normal operating condition for HDC.
- The cluster icon and switch indicator light will flash for several seconds then extinguish when the driver pushes the HDC switch but enable conditions are not met.

- The cluster icon and switch indicator light will flash for several seconds then extinguish when HDC disables due to excess speed.
- The cluster icon and switch indicator light will flash when HDC deactivates due to overheated brakes. The flashing will stop and HDC will activate again once the brakes have cooled sufficiently.

**WARNING!**

HDC is only intended to assist the driver in controlling vehicle speed when descending hills. The driver must remain attentive to the driving conditions and is responsible for maintaining a safe vehicle speed.

**Hill Start Assist (HSA)**

The HSA system is designed to mitigate roll back from a complete stop while on an incline. If the driver releases the brake while stopped on an incline, HSA will continue to hold the brake pressure for a short period. If the driver does not apply the throttle before this time expires, the system will release brake pressure and the vehicle will roll down the hill as normal.

The following conditions must be met in order for HSA to activate:

- The feature must be enabled.
- The vehicle must be stopped.
- The parking brake must be off.
- The driver door must be closed. (If the doors are attached, then the door must be closed. If the doors are detached then the driver's seat belt must be buckled.)
- The vehicle must be on a sufficient grade.
- The gear selection must match vehicle uphill direction (i.e., vehicle facing uphill is in forward gear; vehicle backing uphill is in REVERSE gear).
- HSA will work in REVERSE gear and all forward gears. The system will not activate if the transmission is in PARK or NEUTRAL. For vehicles equipped with a manual transmission, if the clutch is pressed, HSA will remain active.

#### WARNING!

There may be situations where the Hill Start Assist (HSA) will not activate and slight rolling may occur, such as on minor hills or with a loaded vehicle, or while pulling a trailer. HSA is not a substitute for active driving involvement. It is always the driver's responsibility to be attentive to distance to other vehicles, people, and objects, and most importantly brake operation to ensure safe operation of the vehicle under all road conditions. Your complete attention is always required while driving to maintain safe control of your vehicle. Failure to follow these warnings can result in a collision or serious personal injury.

#### Disabling And Enabling HSA

This feature can be turned on or turned off. To change the current setting, refer to [☞ page 207](#) for further information.

#### Towing With HSA

HSA will also provide assistance to mitigate roll back while towing a trailer.

#### WARNING!

- If you use a trailer brake controller with your trailer, the trailer brakes may be activated and deactivated with the brake switch. If so, there may not be enough brake pressure to hold both the vehicle and the trailer on a hill when the brake pedal is released. In order to avoid rolling down an incline while resuming acceleration, manually activate the trailer brake or apply more vehicle brake pressure prior to releasing the brake pedal.
- HSA is not a parking brake. Always apply the parking brake fully when exiting your vehicle. Also, be certain to place the transmission in PARK (P).
- Failure to follow these warnings can result in a collision or serious personal injury.

#### Rain Brake Support (RBS)

RBS may improve braking performance in wet conditions. It will periodically apply a small amount of brake pressure to remove any water buildup on the front brake rotors. It functions when the windshield wipers are in LO or HI speed. When RBS is active, there is no notification to the driver and no driver interaction is required.

## Ready Alert Braking (RAB)

RAB may reduce the time required to reach full braking during emergency braking situations. It anticipates when an emergency braking situation may occur by monitoring how fast the throttle is released by the driver. The Electronic Brake Controller (EBC) will prepare the brake system for a panic stop.

## Rear Seat Reminder Alert (RSRA) — If Equipped

RSRA will consider the presence of an object in the rear seat when a rear entry/exit door is opened at the beginning of each key cycle. To activate, the rear door must be open for more than one second and the vehicle must be placed in the RUN position within 10 minutes. When the potential presence of an object is determined and/or otherwise inferred, a message will appear in the cluster display reminding driver to check the rear seat(s) immediately after key off, accompanied by an alert upon exiting the vehicle.

## Selec-Speed Control (SSC) — If Equipped



SSC is intended for off-road driving in 4WD Low only. SSC maintains vehicle speed by actively controlling engine torque and brakes.

SSC has three states:

1. Off (feature is not enabled and will not activate)
2. Enabled (feature is enabled and ready but activation conditions are not met, or driver is actively overriding with brake or throttle application)
3. Active (feature is enabled and actively controlling vehicle speed)

### Enabling SSC

SSC is enabled by pushing the SSC switch, but the following conditions must also be met to enable SSC:

- The driveline is in 4WD Low.
- The vehicle speed is below 5 mph (8 km/h).
- The parking brake is released.
- The driver door is closed (If doors are attached, the door must be closed. If doors are detached, the driver seat belt must be buckled).
- The driver is not applying throttle.

### Activating SSC

Once SSC is enabled it will activate automatically once the following conditions are met:

- The driver releases the throttle.
- The driver releases the brake.
- The driver seat belt is buckled.

- The transmission is in any selection other than PARK.
- Your vehicle speed is below 20 mph (32 km/h).
- The driver door is closed. (If doors are attached, the door must be closed. If doors are detached, the driver seat belt must be buckled).

The set speed for SSC is selectable by the driver, and can be adjusted by using the gear shift +/- . Additionally, the SSC set speed may be reduced when climbing a grade and the level of set speed reduction depends on the magnitude of grade. The following summarizes the SSC set speeds:

### SSC Target Set Speeds

- 1st = 0.6 mph (1 km/h)
- 2nd = 1.2 mph (2 km/h)
- 3rd = 1.8 mph (3 km/h)
- 4th = 2.5 mph (4 km/h)
- 5th = 3.1 mph (5 km/h)
- 6th = 3.7 mph (6 km/h)
- 7th = 4.3 mph (7 km/h)
- 8th = 5 mph (8 km/h)
- 9th = 5.6 mph (9 km/h) — if equipped
- REVERSE = 0.6 mph (1 km/h)
- NEUTRAL = 1.2 mph (2 km/h)
- PARK = SSC remains enabled but not active

### SSC Target Set Speeds – If Equipped With Off Road+

- 1st = 0.6 mph (1 km/h)
- 2nd = 0.9 mph (1.5 km/h)
- 3rd = 1.2 mph (2 km/h)
- 4th = 1.5 mph (2.5 km/h)
- 5th = 1.8 mph (3 km/h)
- 6th = 2.5 mph (4 km/h)
- 7th = 3.7 mph (6 km/h)
- 8th = 5 mph (8 km/h)
- REVERSE = 0.6 mph (1 km/h)
- NEUTRAL = 1.2 mph (2 km/h)
- PARK = SSC remains enabled but not active

#### NOTE:

- During SSC, the +/- gear selector input is used for SSC target speed selection but will not affect the gear chosen by the transmission. While actively controlling SSC, the transmission will shift appropriately for the driver-selected set speed and corresponding driving conditions.
- SSC operation is influenced by Off Road+ drive mode if active. The differences may be notable to the driver as a varying level of aggressiveness.

### Driver Override

The driver may override SSC activation with throttle or brake application at any time.

#### Deactivating SSC

SSC will be deactivated but remain available if any of the following conditions occur:

- The driver overrides SSC set speed with throttle or brake application.
- The vehicle speed exceeds 20 mph (32 km/h) but remains below 40 mph (64 km/h).
- The vehicle is shifted into PARK.

#### Disabling SSC

SSC will deactivate and be disabled if any of the following conditions occur:

- The driver pushes the SSC switch.
- The driveline is shifted out of the 4WD Low.
- The parking brake is applied.
- The vehicle is driven greater than 20 mph (32 km/h) for greater than 70 seconds.
- The vehicle is driven greater than 40 mph (64 km/h). SSC will exist immediately.
- The driver door opens. (Driver door opens if doors are attached or driver seat belt is unbuckled if doors are detached).

### Feedback To The Driver

The instrument cluster has an SSC icon and the SSC switch has a lamp that offers feedback to the driver about the state SSC is in.

- The cluster icon and switch lamp will illuminate and remain on solid when SSC is enabled or activated. These are the normal operating conditions for SSC.
- The cluster icon and switch lamp will flash for several seconds then extinguish when the driver pushes the SSC switch but enabled conditions are not met.
- The cluster icon and switch lamp will flash for several seconds then extinguish when SSC disables due to excess speed.
- The cluster icon and switch lamp will flash then extinguish when SSC deactivates due to overheated brakes.

#### WARNING!

SSC is only intended to assist the driver in controlling vehicle speed when driving in off-road conditions. The driver must remain attentive to the driving conditions and is responsible for maintaining a safe vehicle speed.

## Traction Control System (TCS)

TCS monitors the amount of wheel spin of each of the driven wheels. If wheel spin is detected, the TCS may apply brake pressure to the spinning wheel(s) and/or reduce engine power to provide enhanced acceleration and stability. A feature of the TCS, Brake Limited Differential (BLD) functions similarly to a limited slip differential and controls the wheel spin across a driven axle. If one wheel on a driven axle is spinning faster than the other, the system will apply the brake of the spinning wheel. This will allow more engine torque to be applied to the wheel that is not spinning. BLD may remain enabled even if TCS and Electronic Stability Control (ESC) are in reduced modes.

## Trailer Sway Control (TSC)

TSC uses sensors in the vehicle to recognize an excessively swaying trailer and will take the appropriate actions to attempt to stop the sway.

### NOTE:

TSC cannot stop all trailers from swaying. Always use caution when towing a trailer and follow the trailer tongue weight recommendations  
 ⇨ page 192.

When TSC is functioning, the ESC Activation/Malfunction Indicator Light will flash, the engine power may be reduced and you may feel the brakes being applied to individual wheels to attempt to stop the trailer from swaying. TSC is

disabled when the ESC system is in the “Partial Off” or “Full Off” modes.

### WARNING!

If TSC activates while driving, slow the vehicle down, stop at the nearest safe location, and adjust the trailer load to eliminate trailer sway.

## AUXILIARY DRIVING SYSTEMS

### BLIND SPOT MONITORING (BSM) — IF EQUIPPED

The BSM system uses two radar sensors, located inside the taillights, to detect highway licensable vehicles (automobiles, trucks, motorcycles, etc.) that enter the blind spot zones from the rear/front/side of the vehicle.

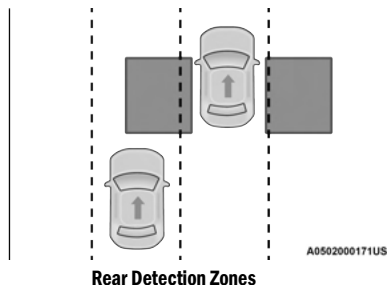

When the vehicle is started, the BSM Warning Light will momentarily illuminate in both outside rearview mirrors to let the driver know that the system is operational. The BSM system sensors operate when the vehicle is in any forward gear and enters standby mode when the vehicle is in PARK (P).

The BSM detection zone covers approximately one lane width on both sides of the vehicle 12 ft (3.8 m). The zone length starts at the outside rearview mirror and extends approximately 10 ft (3 m) beyond the rear fascia/bumper of the vehicle. The BSM system monitors the detection zones on both sides of the vehicle when the vehicle speed reaches approximately 6 mph (10 km/h) or higher and will alert the driver of vehicles in these areas.

### NOTE:

- The BSM system DOES NOT alert the driver about rapidly approaching vehicles that are outside the detection zones.
- The BSM system detection zone DOES NOT change if your vehicle is towing a trailer. Therefore, visually verify the adjacent lane is clear for both your vehicle and trailer before making a lane change. If the trailer or other object (i.e., bicycle, sports equipment) extends beyond the side of your vehicle, this may result in the BSM

Warning Light remaining illuminated the entire time the vehicle is in a forward gear ⇨ page 207.

- The Blind Spot Monitoring (BSM) system may experience dropouts (blinking on and off) of the side mirror warning indicator lamps when a motorcycle or any small object remains at the side of the vehicle for extended periods of time (more than a couple of seconds).

The BSM system can become blocked if snow, ice, mud, or other road contaminations accumulate on the rear fascia/bumper where the radar sensors are located. The system may also detect blockage if the vehicle is operated in areas with extremely low radar returns such as a desert or parallel to a large elevation drop. If blockage is detected, a “Blind Spot Temporarily Unavailable, Wipe Rear Corners” message will display in the cluster, both mirror lights will illuminate, and BSM and RCP alerts will not occur. This is normal operation. The system will automatically recover and resume function when the condition clears. To minimize system blockage, do not block the area of the rear fascia/bumper where the radar sensors are located with foreign objects (bumper stickers, bicycle racks, etc.) and keep it clear of road contaminations.

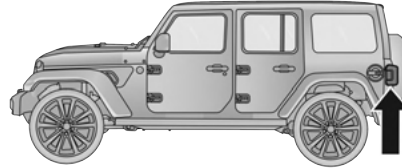

A0502000125US

#### BSM Radar Location (Left Side Shown)

The BSM system notifies the driver of objects in the detection zones by illuminating the BSM Warning Light located in the outside mirrors in addition to sounding an audible (chime) alert and reducing the radio volume ⇨ page 287.

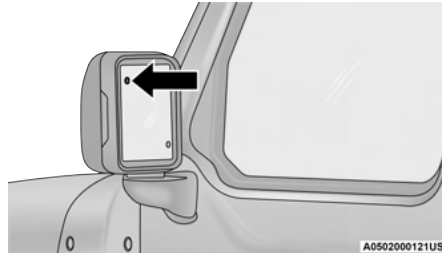

A0502000121US

#### Warning Light Location

The BSM system monitors the detection zone from three different entry points (side, rear, front) while driving to see if an alert is necessary. The BSM system will issue an alert during these types of zone entries.

#### Entering From The Side

Vehicles that move into your adjacent lanes from either side of the vehicle.

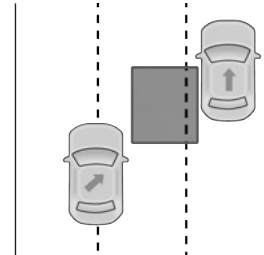

A0502000166US

#### Side Monitoring

### Entering From The Rear

Vehicles that come up from behind your vehicle on either side and enter the rear detection zone with a relative speed of less than 30 mph (48 km/h).

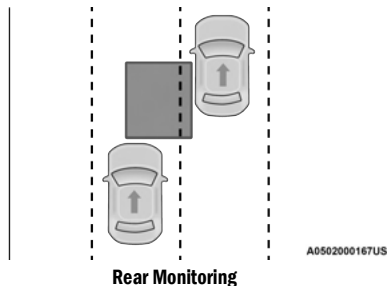

### Overtaking Traffic

If you pass another vehicle slowly with a relative speed less than 15 mph (24 km/h) and the vehicle remains in the blind spot for approximately 1.5 seconds, the warning light will be illuminated. If the difference in speed between the two vehicles is greater than 15 mph (24 km/h), the warning light will not illuminate.

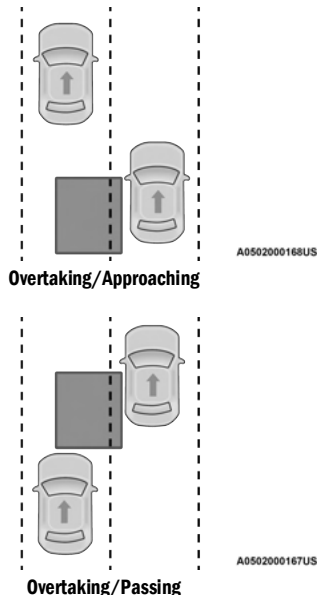

The BSM system is designed not to issue an alert on stationary objects such as guardrails, posts, walls, foliage, berms, etc. However, occasionally the system may alert on such objects. This is normal operation and your vehicle does not require service.

The BSM system will not alert you of objects that are traveling in the opposite direction of the vehicle in adjacent lanes  page 431.

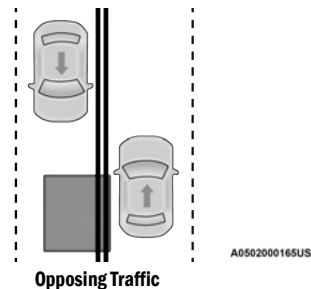

### WARNING!

The Blind Spot Monitoring system is only an aid to help detect objects in the blind spot zones. The BSM system is not designed to detect pedestrians, bicyclists, or animals. Even if your vehicle is equipped with the BSM system, always check your vehicle's mirrors, glance over your shoulder, and use your turn signal before changing lanes. Failure to do so can result in serious injury or death.



## Rear Cross Path (RCP)

RCP is intended to aid the driver when backing out of parking spaces where their vision of oncoming vehicles may be blocked. Proceed slowly and cautiously out of the parking space until the rear end of the vehicle is exposed. The RCP system will then have a clear view of the cross traffic and if an oncoming vehicle is detected, alert the driver.

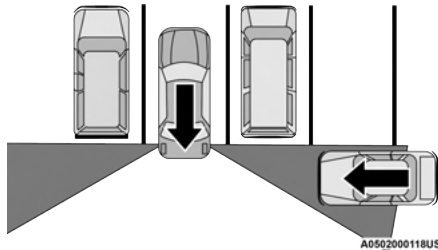

RCP Detection Zones

RCP monitors the rear detection zones on both sides of the vehicle, for objects that are moving toward the side of the vehicle with a minimum speed of approximately 3 mph (5 km/h), to objects moving a maximum of approximately 20 mph (32 km/h), such as in parking lot situations.

When RCP is on and the vehicle is in REVERSE, the driver is alerted using both the visual and audible alarms, including reducing the radio volume.

### NOTE:

In a parking lot situation, oncoming vehicles can be blocked by vehicles parked on either side. If the sensors are blocked by other structures or vehicles, the system will not be able to alert the driver.

### WARNING!

Rear Cross Path Detection (RCP) is not a backup aid system. It is intended to be used to help a driver detect an oncoming vehicle in a parking lot situation. Drivers must be careful when backing up, even when using RCP. Always check carefully behind your vehicle, look behind you, and be sure to check for pedestrians, animals, other vehicles, obstructions, and blind spots before backing up. Failure to do so can result in serious injury or death.

## Blind Spot Modes

Blind Spot has three selectable modes of operation that are available in the Uconnect system.

### Blind Spot Alert Lights Only

When operating in Blind Spot Alert mode, the BSM system will provide a visual alert in the appropriate side view mirror based on a detected object. However, when the system is operating in Rear

Cross Path (RCP) mode, the system will respond with both visual and audible alerts when a detected object is present. Whenever an audible alert is requested, the radio is muted.

### Blind Spot Alert Lights/Chime

When operating in Blind Spot Alert Lights/Chime mode, the BSM system will provide a visual alert in the appropriate side view mirror based on a detected object. If the turn signal is then activated, and it corresponds to an alert present on that side of the vehicle, an audible chime will also be sounded. Whenever a turn signal and detected object are present on the same side at the same time, both the visual and audible alerts will be issued. In addition to the audible alert the radio (if on) will also be muted.

### NOTE:

Whenever an audible alert is requested by the BSM system, the radio is also muted.

When the system is in RCP, the system shall respond with both visual and audible alerts when a detected object is present. Whenever an audible alert is requested, the radio is also muted. Turn/hazard signal status is ignored; the RCP state always requests the chime.

### Blind Spot Alert Off

When the BSM system is turned off there will be no visual or audible alerts from either the BSM or RCP systems.

#### NOTE:

The BSM system will store the current operating mode when the vehicle is shut off. Each time the vehicle is started the previously stored mode will be recalled and used.

### Door Removal

When either the front driver or passenger door is removed, the instrument cluster will display “Blind Spot Temporarily Unavailable” and the BSM system will disable. While the system will continue to indicate whatever blind spot mode it was previously in within the Uconnect system, no visual or audible alerts will be provided. As long as the doors are removed, the instrument cluster will provide the “Blind Spot Temporarily Unavailable” pop-up as a reminder that the system is disabled every time the ignition is cycled.

Upon re-installation of both doors, the system will resume functionality based on the personalized mode selected.

## FORWARD COLLISION WARNING (FCW) WITH MITIGATION — IF EQUIPPED

The FCW with Mitigation system provides the driver with audible warnings, visual warnings (within the

instrument cluster display), and may apply a haptic warning in the form of a brake jerk, to warn the driver when it detects a potential frontal collision. The warnings are intended to provide the driver with enough time to react, avoid or mitigate the potential collision.

#### NOTE:

FCW monitors the information from the forward looking sensors as well as Electronic Brake Controller (EBC), to calculate the probability of a forward collision. When the system determines that a forward collision is probable, the driver will be provided with audible and visual warnings as well as a possible haptic warning in the form of a brake jerk.

If the driver does not take action based upon these progressive warnings, then the system will provide a limited level of active braking to help slow the vehicle and mitigate the potential forward collision. If the driver reacts to the warnings by braking and the system determines that the driver intends to avoid the collision by braking but has not applied sufficient brake force, the system will compensate and provide additional brake force as required.

If a FCW with Mitigation event begins at a speed below 32 mph (52 km/h), the system may provide the maximum braking possible to mitigate the potential forward collision. If the Forward Collision Warning with Mitigation event stops the vehicle

completely, the system will hold the vehicle at standstill for two seconds and then release the brakes.



FCW Message

When the system determines a collision with the vehicle in front of you is no longer probable, the warning message will be deactivated → page 431.

#### NOTE:

- The minimum speed for FCW activation is 3 mph (5 km/h).
- The FCW alerts may be triggered on objects other than vehicles such as guardrails or sign posts based on the course prediction. This is expected and is a part of normal FCW activation and functionality.

- It is unsafe to test the FCW system. To prevent such misuse of the system, after four Active Braking events within a key cycle, the Active Braking portion of FCW will be deactivated until the next key cycle.
- The FCW system is intended for on-road use only. If the vehicle is taken off-road, the FCW system should be deactivated to prevent unnecessary warnings to the surroundings.
- FCW may not react to irrelevant objects such as overhead objects, ground reflections, objects not in the path of the vehicle, stationary objects that are far away, oncoming traffic, or leading vehicles with the same or higher rate of speed.
- FCW will be disabled like ACC, with the unavailable screens.

#### WARNING!

Forward Collision Warning (FCW) is not intended to avoid a collision on its own, nor can FCW detect every type of potential collision. In rare situations, the system may react to surrounding objects such as tunnels, bridges, guardrails, etc. The driver has the responsibility to avoid a collision by controlling the vehicle via braking, steering, and acceleration. Unintended braking reactions can always be overridden by pressing down hard on the accelerator. Failure to follow this warning could lead to serious injury or death.

### Turning FCW On Or Off

The FCW setting menu can be adjusted through the Uconnect Settings ⇨ page 207.

- To turn the FCW system on, select between “Only Warning” and “Warning and Braking” in the FCW menu.
- Select “OFF” in the FCW menu to turn the FCW system off.

#### NOTE:

- When the FCW is “on”, this allows the system to warn the driver of a possible collision with the vehicle in front.
- When the FCW is “off”, this prevents the system from warning the driver of a possible collision with the vehicle in front. If the FCW is set to “off”, “FCW OFF” will be displayed in the instrument cluster display.
- When FCW status is set to “Only Warning”, this prevents the system from providing limited active braking, or additional brake support if the driver is not braking adequately in the event of a potential frontal collision.
- When FCW status is set to “Warning and Braking”, this allows the system to warn the driver of a possible collision with the vehicle in

front using audible/visual warnings and it applies autonomous braking.

- The system will retain the last setting selected by the driver after ignition shutdown.

### FCW Braking Status And Sensitivity

The FCW Sensitivity and Active Braking status are programmable through the Uconnect system ⇨ page 207.

- Far
  - When the sensitivity of FCW is set to the “Far” setting, this allows the system to warn the driver of a possible more distant collision with the vehicle in front using audible/visual warnings.
  - More cautious drivers that do not mind frequent warnings may prefer this setting.

#### NOTE:

The “Far” setting may result in a greater number of FCW possible collision warnings experienced.

- Medium
  - When the sensitivity of FCW is set to the “Medium” setting, this allows the system to warn the driver of a possible collision with the vehicle in front using audible/visual warnings.

- Near
  - When the sensitivity of FCW is set to the “Near” setting, this allows the system to warn the driver of a possible closer collision with the vehicle in front using audible/visual warnings.
  - This setting provides less reaction time than the “Far” and “Medium” settings, which allows for a more dynamic driving experience.
  - More dynamic or aggressive drivers that want to avoid frequent warnings may prefer this setting.

**NOTE:**

The “Near” setting may result in a lesser number of FCW possible collision warnings experienced.

**FCW Limited Warning**

If the instrument cluster displays “ACC/FCW Limited Functionality” or “ACC/FCW Limited Functionality Clean Front Windshield” momentarily, there may be a condition that limits FCW functionality. Although the vehicle is still drivable under normal conditions, the active braking may not be fully available. Once the condition that limited the system performance is no longer present, the system will return to its full performance state. If the problem persists, see an authorized dealer.

**Service FCW Warning**

If the system turns off, and the instrument cluster displays:

- ACC/FCW Unavailable Service Required
- Cruise/FCW Unavailable Service Required

This indicates there is an internal system fault. Although the vehicle is still drivable under normal conditions, have the system checked by an authorized dealer.

**TIRE PRESSURE MONITORING SYSTEM (TPMS)**

The Tire Pressure Monitoring System (TPMS) will warn the driver of a low tire pressure based on the vehicle recommended cold placard pressure.

**NOTE:**

The alert warning on the cluster will stay on until the tire is inflated to the placard pressure.

The tire pressure will vary with temperature by approximately 1 psi (7 kPa) for every 12°F (6.5°C). This means that when the outside temperature decreases, the tire pressure will decrease. Tire pressure should always be set based on cold inflation tire pressure. This is defined as the tire pressure after the vehicle has not been driven for at least three hours, or driven less than 1 mile (1.6 km) after a three hour period. The cold tire

inflation pressure must not exceed the maximum inflation pressure molded into the tire sidewall. The tire pressure will also increase as the vehicle is driven. This is normal and there should be no adjustment for this increased pressure.

See ⇨ page 391 on how to properly inflate the vehicle’s tires.

The TPMS will warn the driver of a low tire pressure if the tire pressure falls below the low-pressure warning limit for any reason, including low temperature effects and natural pressure loss through the tire.

The TPMS will continue to warn the driver of low tire pressure as long as the condition exists, and will not turn off until the tire pressure is at or above the recommended cold placard pressure. Once the low tire pressure warning (Tire Pressure Monitoring System Warning Light) illuminates, you must increase the tire pressure to the recommended cold placard pressure in order for the TPMS Warning Light to turn off.

**NOTE:**

When filling warm tires, the tire pressure may need to be increased up to an additional 4 psi (28 kPa) above the recommended cold placard pressure in order to turn the TPMS Warning Light off.

The system will automatically update and the TPMS Warning Light will turn off once the system receives the updated tire pressures. The vehicle may need to be driven for up to 20 minutes above 15 mph (24 km/h) in order for the TPMS to receive this information.

For example, your vehicle may have a recommended cold (parked for more than three hours) placard pressure of 33 psi (227 kPa). If the ambient temperature is 68°F (20°C) and the measured tire pressure is 28 psi (193 kPa), a temperature drop to 20°F (-7°C) will decrease the tire pressure to approximately 24 psi (165 kPa). This tire pressure is low enough to turn on the TPMS Warning Light. Driving the vehicle may cause the tire pressure to rise to approximately 28 psi (193 kPa), but the TPMS Warning Light will still be on. In this situation, the TPMS Warning Light will turn off only after the tires are inflated to the vehicle's recommended cold placard pressure value → page 431.

**NOTE:**

When filling warm tires, the tire pressure may need to be increased up to an additional 4 psi (28 kPa) above the recommended cold placard pressure in order to turn the TPMS Warning Light off.

**CAUTION!**

- The TPMS has been optimized for the original equipment tires and wheels. TPMS pressures and warning have been established for the tire size equipped on your vehicle. Undesirable system operation or sensor damage may result when using replacement equipment that is not of the same size, type, and/or style. The TPMS sensor is not designed for use on aftermarket wheels, and may contribute to a poor overall system performance. Customers are encouraged to use Original Equipment Manufacturer (OEM) wheels to ensure TPMS feature operation.
- Using aftermarket tire sealants may cause the Tire Pressure Monitoring System (TPMS) sensor to become inoperable. After using an aftermarket tire sealant it is recommended that you take your vehicle to an authorized dealer to have your sensor function checked.
- After inspecting or adjusting the tire pressure always reinstall the valve stem cap. This will prevent moisture and dirt from entering the valve stem, which could damage the TPMS sensor.

**NOTE:**

- The TPMS is not intended to replace normal tire care and maintenance, or to provide warning of a tire failure or condition.
- The TPMS should not be used as a tire pressure gauge while adjusting your tire pressure, unless your vehicle is equipped with a Tire Fill Alert or Selectable Tire Fill Alert feature.
- Driving on a significantly underinflated tire causes the tire to overheat and can lead to tire failure. Underinflation also reduces fuel efficiency and tire tread life, and may affect the vehicle's handling and stopping ability.
- The TPMS is not a substitute for proper tire maintenance, and it is the driver's responsibility to maintain correct tire pressure using an accurate tire pressure gauge, even if underinflation has not reached the level to trigger illumination of the TPMS Warning Light.
- Seasonal temperature changes will affect tire pressure, and the TPMS will monitor the actual tire pressure in the tire.

## System Operation

The Tire Pressure Monitoring System (TPMS) uses wireless technology with wheel rim mounted electronic sensors to monitor tire pressure levels. Sensors, mounted to each wheel as part of the valve stem, transmit tire pressure readings to the receiver module.

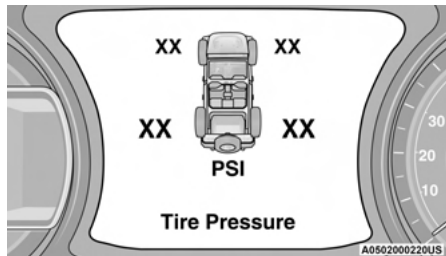

**Tire Pressure Monitoring System Display**

### NOTE:

It is particularly important for you to check the tire pressure in all of the tires on your vehicle monthly and to maintain the proper pressure.

The TPMS consists of the following components:

- Receiver module
- Four Tire Pressure Monitoring System sensors
- Various Tire Pressure Monitoring System messages, which display in the instrument cluster

- Tire Pressure Monitoring Warning Light

## TIRE PRESSURE MONITORING SYSTEM LOW PRESSURE WARNINGS



The TPMS Warning Light will illuminate in the instrument cluster and a chime will sound when tire pressure is low in one or more of the four active road tires. In addition, the instrument cluster will display a "Tire Low" message for a minimum of five seconds, an "Inflate to XX" message and a graphic showing the pressure values of each tire with the low tire pressure values in a different color.

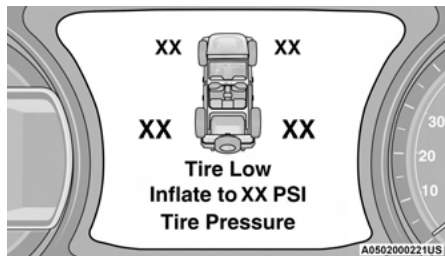

**Tire Pressure Monitoring System Low Pressure Warning**

Should this occur, you should stop as soon as possible and inflate the tires with low pressure (those in a different color in the instrument cluster graphic) to the vehicle's recommended cold placard pressure value as shown in the "Inflate to

XX" message. Once the system receives the updated tire pressures, the system will automatically update, the pressure values in the graphic display in the instrument cluster will return to their original color, and the TPMS Warning Light will turn off.

### NOTE:

When filling warm tires, the tire pressure may need to be increased up to an additional 4 psi (28 kPa) above the recommended cold placard pressure in order to turn the TPMS Warning Light off.

The vehicle may need to be driven for up to 20 minutes above 15 mph (24 km/h) in order for the TPMS to receive this information.

## SERVICE TPMS WARNING

When a system fault is detected, the TPMS Warning Light will flash on and off for 75 seconds and then remain on solid. The system fault will also sound a chime. In addition, the instrument cluster will display a "SERVICE TIRE PRESSURE SYSTEM" message for a minimum of five seconds and then display dashes (-) in place of the pressure value to indicate which sensor is not being received.

If the ignition is cycled, this sequence will repeat, providing the system fault still exists. If the system fault no longer exists, the TPMS Warning Light will no longer flash, and the "SERVICE TIRE PRESSURE SYSTEM" message will no longer display, and a pressure value will display in place of the dashes.

A system fault can occur due to any of the following:

- Jamming due to electronic devices or driving next to facilities emitting the same radio frequencies as the TPMS sensors
- Installing some form of aftermarket window tinting that affects radio wave signals
- Lots of snow or ice around the wheels or wheel housings
- Using tire chains on the vehicle
- Using wheels/tires not equipped with TPMS sensors

#### Vehicles With A Full-Size Matching Spare

1. If your vehicle is equipped with a matching full-size spare wheel and tire assembly, it has a Tire Pressure Monitoring System sensor, and can be monitored by the Tire Pressure Monitoring System (TPMS) when swapped with a low pressure road tire.
2. In the event that the matching full-size spare tire is swapped with a low pressure road tire, the next ignition switch cycle will still show the TPMS Warning Light to be on, a chime to sound, an Inflate to XX message to appear in the instrument cluster, and the graphic display will still show the low tire pressure value in a different color.

3. Driving the vehicle for up to 20 minutes above 15 mph (24 km/h) will turn off the TPMS Warning Light as long as none of road tires are below the low pressure warning threshold.

#### TPMS DEACTIVATION — IF EQUIPPED

The TPMS can be deactivated if replacing all four wheel and tire assemblies (road tires) with wheel and tire assemblies that do not have TPMS sensors, such as when installing winter wheel and tire assemblies on your vehicle.

To deactivate the TPMS, first replace all four wheel and tire assemblies (road tires) with tires not equipped with Tire Pressure Monitoring System sensors. Then, drive the vehicle for 20 minutes above 15 mph (24 km/h). The TPMS will chime, the TPMS Warning Light will flash on and off for 75 seconds and then remain on. The instrument cluster will display the “SERVICE TIRE PRESSURE SYSTEM” message and then display dashes (–) in place of the pressure values.

Beginning with the next ignition cycle, the TPMS will no longer chime or display the “SERVICE TIRE PRESSURE SYSTEM” message in the instrument cluster but dashes (–) will remain in place of the pressure values.

To reactivate the TPMS, replace all four wheel and tire assemblies (road tires) with tires equipped with TPMS sensors. Then, drive the vehicle for up to 20 minutes above 15 mph (24 km/h). The TPMS

will chime, the TPMS Warning Light will flash on and off for 75 seconds and then turn off. The instrument cluster will display the “SERVICE TIRE PRESSURE SYSTEM” message and then display pressure values in place of the dashes. On the next ignition cycle the “SERVICE TIRE PRESSURE SYSTEM” message will no longer be displayed as long as no system fault exists.

#### TIRE FILL ALERT

This feature notifies the user when the placard tire pressure is attained while inflating or deflating the tire.

The customer may choose to disable or enable the Tire Fill Alert feature in the customer settings menu of the Uconnect system.

#### NOTE:

- Only one tire can be filled at a time when using the Tire Fill Alert system.
- The Tire Fill Alert feature cannot be entered if an existing TPMS fault is set to “active” or if the system is in deactivation mode (if equipped).

The system will be activated when the system detects an increase in tire pressure while filling the tire. The ignition must be in the ON/RUN mode with the transmission in PARK for vehicles equipped with an automatic transmission. For vehicles equipped with a manual transmission, the parking brake must be applied.

**NOTE:**

It is not required to have the engine running to enter Tire Fill Alert mode.

The hazard lamps will come on to confirm the vehicle is in Tire Fill Alert mode. If the hazard lamps do not come on while inflating the tire, the Tire Pressure Monitoring System sensor may be in an inoperative position, preventing the TPMS sensor signal from being received. In this case, the vehicle may need to be moved slightly forward or backward.

When Tire Fill Alert mode is entered, the tire pressure display screen will be displayed in the instrument cluster.

**Operation:**

- The horn will chirp once to let the user know when to stop filling the tire, when it reaches recommended pressure.
- The horn will chirp three times if the tire is over-filled and will continue to chirp every five seconds if the user continues to inflate the tire.
- The horn will chirp once again when enough air is let out to reach proper inflation level.
- The horn will also chirp three times if the tire is then underinflated and will continue to chirp every five seconds if the user continues to deflate the tire.

**NOTE:**

The Tire Fill Alert feature is set to “Disabled” every time the ignition is turned to “OFF”. To re-enable the Tire Fill Alert feature at the next ignition “RUN” state, the customer must re-enable the feature through use of the customer settings in the radio.

**SELECTABLE TIRE FILL ALERT (STFA) – IF EQUIPPED**

The STFA system is an optional feature that is included as part of the normal Tire Fill Alert system. The system is designed to allow you to select a pressure to inflate or deflate the vehicle's front and rear axle tires to, and to provide feedback while inflating or deflating the vehicle's tires.

**NOTE:**

To use the STFA feature, the Tire Fill Alert feature must be enabled through use of the customer settings in the radio.

In the Selectable Tire Fill Alert application, which is located in the apps menu of the Uconnect system, you will be able to select a pressure setting for both the front and rear axle tire pressures by scrolling through a pressure range from XX to 15 psi in 1 psi increments for each axle setting.

XX = the vehicle's cold placard pressure values for the front and rear axles as shown on the vehicle placard pressure label.

You may also store pressure values chosen for each axle in the Uconnect system application as preset pressure values. Up to two sets of preset pressure values can be stored in the Uconnect system for the front and rear axle. Once you select the tire pressures for the front and rear axles that you want to inflate or deflate to, you can begin inflating or deflating one tire at a time.

**NOTE:**

The STFA system will only support inflating or deflating one tire at a time.

The system will be activated when the TPMS receiver module detects a change in tire pressure. The ignition must be in the ON/RUN mode, with the transmission in PARK in vehicles with an automatic transmission, and in NEUTRAL with the parking brake engaged in vehicles with a manual transmission. The hazard lamps will come on to confirm the vehicle is in Tire Fill Alert mode.

When Tire Fill Alert mode is entered, the tire pressure screen will be displayed in the instrument cluster. If the hazard lamps do not come on while inflating or deflating the tire, the Tire Pressure Monitoring System sensor may be in an inoperative position, preventing the TPMS sensor signal from being received. In this case, the vehicle may need to be moved slightly forward or backward.



Horn chirps will indicate STFA status as tires are inflated/deflated. The horn will chirp under the following STFA states:

1. The horn will chirp once when the selected pressure is reached to let you know when to stop inflating or deflating the tire.
2. The horn will chirp three times if the tire is over-inflated or over-deflated.
3. The horn will chirp once again when enough air is added or removed to reach proper selected pressure level.

## OCCUPANT RESTRAINT SYSTEMS

Some of the most important safety features in your vehicle are the restraint systems:

### OCCUPANT RESTRAINT SYSTEMS FEATURES

- Seat Belt Systems
- Supplemental Restraint Systems (SRS) Air Bags
- Child Restraints

Some of the safety features described in this section may be standard equipment on some models, or may be optional equipment on others. If you are not sure, ask an authorized dealer.

## IMPORTANT SAFETY PRECAUTIONS

Please pay close attention to the information in this section. It tells you how to use your restraint system properly, to keep you and your passengers as safe as possible.

Here are some simple steps you can take to minimize the risk of harm from a deploying air bag:

1. Children 12 years old and under should always ride buckled up in the rear seat of a vehicle with a rear seat.
2. A child who is not big enough to wear the vehicle seat belt properly must be secured in the appropriate child restraint or belt-positioning booster seat in a rear seating position ⇨ page 314.
3. If a child from 2 to 12 years old (not in a rear-facing child restraint) must ride in the front passenger seat, move the seat as far back as possible and use the proper child restraint ⇨ page 314.
4. Never allow children to slide the shoulder belt behind them or under their arm.
5. You should read the instructions provided with your child restraint to make sure that you are using it properly.
6. All occupants should always wear their lap and shoulder belts properly.

7. The driver and front passenger seats should be moved back as far as practical to allow the front air bags room to inflate.
8. Do not lean against the door or window. If your vehicle has side air bags, and deployment occurs, the side air bags will inflate forcefully into the space between occupants and the door and occupants could be injured.
9. If the air bag system in this vehicle needs to be modified to accommodate a disabled person, see ⇨ page 428 for customer service contact information.

### WARNING!

- Never place a rear-facing child restraint in front of an air bag. A deploying passenger front air bag can cause death or serious injury to a child 12 years or younger, including a child in a rear-facing child restraint.
- Never install a rear-facing child restraint in the front seat of a vehicle. Only use a rear-facing child restraint in the rear seat. If the vehicle does not have a rear seat, do not transport a rear-facing child restraint in that vehicle.

## SEAT BELT SYSTEMS

Buckle up even though you are an excellent driver, even on short trips. Someone on the road may be a poor driver and could cause a collision that includes you. This can happen far away from home or on your own street.

Research has shown that seat belts save lives, and they can reduce the seriousness of injuries in a collision. Some of the worst injuries happen when people are thrown from the vehicle. Seat belts reduce the possibility of ejection and the risk of injury caused by striking the inside of the vehicle. Everyone in a motor vehicle should be belted at all times.

### Enhanced Seat Belt Use Reminder System (BeltAlert)

#### Driver And Passenger BeltAlert — If Equipped



BeltAlert is a feature intended to remind the driver and outboard front seat passenger (if equipped with outboard front passenger seat BeltAlert) to buckle their seat belts. The BeltAlert feature is active whenever the ignition switch is in the START or ON/RUN position.

#### Initial Indication

If the driver is unbuckled when the ignition switch is first in the START or ON/RUN position, a chime will signal for a few seconds. If the driver or

outboard front seat passenger (if equipped with outboard front passenger seat BeltAlert) is unbuckled when the ignition switch is first in the START or ON/RUN position the Seat Belt Reminder Light will turn on and remain on until both outboard front seat belts are buckled. The outboard front passenger seat BeltAlert is not active when an outboard front passenger seat is unoccupied.

#### BeltAlert Warning Sequence

The BeltAlert warning sequence is activated when the vehicle is moving above a specified vehicle speed range and the driver or outboard front seat passenger is unbuckled (if equipped with outboard front passenger seat BeltAlert) (the outboard front passenger seat BeltAlert is not active when the outboard front passenger seat is unoccupied). The BeltAlert warning sequence starts by blinking the Seat Belt Reminder Light and sounding an intermittent chime. Once the BeltAlert warning sequence has completed, the Seat Belt Reminder Light will remain on until the seat belts are buckled. The BeltAlert warning sequence may repeat based on vehicle speed until the driver and occupied outboard front seat passenger seat belts are buckled. The driver should instruct all occupants to buckle their seat belts.

#### Change Of Status

If the driver or outboard front seat passenger (if equipped with outboard front passenger seat BeltAlert) unbuckles their seat belt while the

vehicle is traveling, the BeltAlert warning sequence will begin until the seat belts are buckled again.

The outboard front passenger seat BeltAlert is not active when the outboard front passenger seat is unoccupied. BeltAlert may be triggered when an animal or other items are placed on the outboard front passenger seat or when the seat is folded flat (if equipped). It is recommended that pets be restrained in the rear seat (if equipped) in pet harnesses or pet carriers that are secured by seat belts, and cargo is properly stowed.

BeltAlert can be activated or deactivated by an authorized dealer. FCA US LLC does not recommend deactivating BeltAlert.

#### NOTE:

If BeltAlert has been deactivated and the driver or outboard front seat passenger (if equipped with outboard front passenger seat BeltAlert) is unbuckled the Seat Belt Reminder Light will turn on and remain on until the driver and outboard front seat passenger seat belts are buckled.

#### Lap/Shoulder Belts

All seating positions in your vehicle are equipped with lap/shoulder belts.

The seat belt webbing retractor will lock only during very sudden stops or collisions. This feature allows the shoulder part of the seat belt to move freely with you under normal conditions. However, in a

collision the seat belt will lock and reduce your risk of striking the inside of the vehicle or being thrown out of the vehicle.

#### WARNING!

- Relying on the air bags alone could lead to more severe injuries in a collision. The air bags work with your seat belt to restrain you properly. In some collisions, the air bags won't deploy at all. Always wear your seat belt even though you have air bags.
- In a collision, you and your passengers can suffer much greater injuries if you are not properly buckled up. You can strike the interior of your vehicle or other passengers, or you can be thrown out of the vehicle. Always be sure you and others in your vehicle are buckled up properly.
- It is dangerous to ride in a cargo area, inside or outside of a vehicle. In a collision, people riding in these areas are more likely to be seriously injured or killed.
- Do not allow people to ride in any area of your vehicle that is not equipped with seats and seat belts.

*(Continued)*

#### WARNING!

- Be sure everyone in your vehicle is in a seat and using a seat belt properly. Occupants, including the driver, should always wear their seat belts whether or not an air bag is also provided at their seating position to minimize the risk of severe injury or death in the event of a crash.
- Wearing your seat belt incorrectly could make your injuries in a collision much worse. You might suffer internal injuries, or you could even slide out of the seat belt. Follow these instructions to wear your seat belt safely and to keep your passengers safe, too.
- Two people should never be belted into a single seat belt. People belted together can crash into one another in a collision, hurting one another badly. Never use a lap/shoulder belt or a lap belt for more than one person, no matter what their size.

#### WARNING!

- A lap belt worn too high can increase the risk of injury in a collision. The seat belt forces won't be at the strong hip and pelvic bones, but across your abdomen. Always wear the lap part of your seat belt as low as possible and keep it snug.
- A twisted seat belt may not protect you properly. In a collision, it could even cut into you. Be sure the seat belt is flat against your body, without twists. If you can't straighten a seat belt in your vehicle, take it to an authorized dealer immediately and have it fixed.
- A seat belt that is buckled into the wrong buckle will not protect you properly. The lap portion could ride too high on your body, possibly causing internal injuries. Always buckle your seat belt into the buckle nearest you.
- A seat belt that is too loose will not protect you properly. In a sudden stop, you could move too far forward, increasing the possibility of injury. Wear your seat belt snugly.

*(Continued)*

**WARNING!**

- A seat belt that is worn under your arm is dangerous. Your body could strike the inside surfaces of the vehicle in a collision, increasing head and neck injury. A seat belt worn under the arm can cause internal injuries. Ribs aren't as strong as shoulder bones. Wear the seat belt over your shoulder so that your strongest bones will take the force in a collision.
- A shoulder belt placed behind you will not protect you from injury during a collision. You are more likely to hit your head in a collision if you do not wear your shoulder belt. The lap and shoulder belt are meant to be used together.
- A frayed or torn seat belt could rip apart in a collision and leave you with no protection. Inspect the seat belt system periodically, checking for cuts, frays, or loose parts. Damaged parts must be replaced immediately. Do not disassemble or modify the seat belt system. If your vehicle is involved in a collision, or if you have questions regarding seat belt or retractor conditions, take your vehicle to an authorized FCA dealer or authorized FCA Certified Collision Care Program facility for inspection.

**Lap/Shoulder Belt Operating Instructions**

1. Enter the vehicle and close the door. Sit back and adjust the seat.
2. The seat belt latch plate is above the back of the front seat, and next to your arm in the rear seat (for vehicles equipped with a rear seat). Grab the latch plate and pull out the seat belt. Slide the latch plate up the webbing as far as necessary to allow the seat belt to go around your lap.

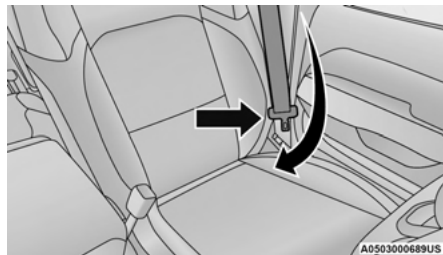
**Pulling Out The Latch Plate**

3. When the seat belt is long enough to fit, insert the latch plate into the buckle until you hear a "click."

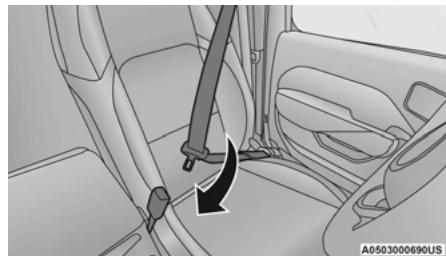
**Inserting Latch Plate Into Buckle**

4. Position the lap belt so that it is snug and lies low across your hips, below your abdomen. To remove slack in the lap belt portion, pull up on the shoulder belt. To loosen the lap belt if it is too tight, tilt the latch plate and pull on the lap belt. A snug seat belt reduces the risk of sliding under the seat belt in a collision.

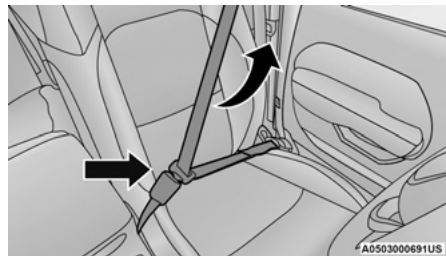
**Positioning The Lap Belt**

- Position the shoulder belt across the shoulder and chest with minimal, if any slack so that it is comfortable and not resting on your neck. The retractor will withdraw any slack in the shoulder belt.
- To release the seat belt, push the red button on the buckle. The seat belt will automatically retract to its stowed position. If necessary, slide the latch plate down the webbing to allow the seat belt to retract fully.

### Lap/Shoulder Belt Untwisting Procedure

Use the following procedure to untwist a twisted lap/shoulder belt.

- Position the latch plate as close as possible to the anchor point.
- At about 6 to 12 inches (15 to 30 cm) above the latch plate, grab and twist the seat belt webbing 180 degrees to create a fold that begins immediately above the latch plate.
- Slide the latch plate upward over the folded webbing. The folded webbing must enter the slot at the top of the latch plate.
- Continue to slide the latch plate up until it clears the folded webbing and the seat belt is no longer twisted.

### Adjustable Upper Shoulder Belt Anchorage

In the driver and outboard front passenger seats, the top of the shoulder belt can be adjusted upward or downward to position the seat belt away from your neck. Push or squeeze the anchorage button to release the anchorage, and move it up or down to the position that serves you best.

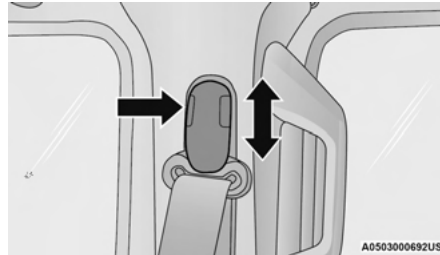

Adjustable Upper Anchorage

As a guide, if you are shorter than average, you will prefer the shoulder belt anchorage in a lower position, and if you are taller than average, you will prefer the shoulder belt anchorage in a higher position. After you release the anchorage button, try to move it up or down to make sure that it is locked in position.

### NOTE:

The adjustable upper shoulder belt anchorage is equipped with an Easy Up feature. This feature allows the shoulder belt anchorage to be adjusted in the upward position without pushing or squeezing the release button. To verify the shoulder belt anchorage is latched, pull downward on the shoulder belt anchorage until it is locked into position.

### WARNING!

- Wearing your seat belt incorrectly could make your injuries in a collision much worse. You might suffer internal injuries, or you could even slide out of the seat belt. Follow these instructions to wear your seat belt safely and to keep your passengers safe, too.
- Position the shoulder belt across the shoulder and chest with minimal, if any slack so that it is comfortable and not resting on your neck. The retractor will withdraw any slack in the shoulder belt.
- Misadjustment of the seat belt could reduce the effectiveness of the safety belt in a crash.
- Always make all seat belt height adjustments when the vehicle is stationary.

## Seat Belt Extender

If a seat belt is not long enough to fit properly, even when the webbing is fully extended and the adjustable upper shoulder belt anchorage (if equipped) is in its lowest position, an authorized dealer can provide you with a Seat Belt Extender. The Seat Belt Extender should be used only if the existing seat belt is not long enough. When the Seat Belt Extender is not required for a different occupant, it must be removed.

### WARNING!

- ONLY use a Seat Belt Extender if it is physically required in order to properly fit the original seat belt system. DO NOT USE the Seat Belt Extender if, when worn, the distance between the front edge of the Seat Belt Extender buckle and the center of the occupant's body is LESS than 6 inches.
- Using a Seat Belt Extender when not needed can increase the risk of serious injury or death in a collision. Only use the Seat Belt Extender when the lap belt is not long enough and only use in the recommended seating positions. Remove and store the Seat Belt Extender when not needed.

## Seat Belts And Pregnant Women

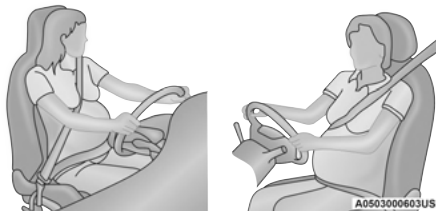

Seat Belts And Pregnant Women

Seat belts must be worn by all occupants including pregnant women: the risk of injury in the event of an accident is reduced for the mother and the unborn child if they are wearing a seat belt.

Position the lap belt snug and low below the abdomen and across the strong bones of the hips. Place the shoulder belt across the chest and away from the neck. Never place the shoulder belt behind the back or under the arm.

### Seat Belt Pretensioner

The front outboard seat belt system is equipped with pretensioning devices that are designed to remove slack from the seat belt in the event of a collision. These devices may improve the performance of the seat belt by removing slack

from the seat belt early in a collision. Pretensioners work for all size occupants, including those in child restraints.

### NOTE:

These devices are not a substitute for proper seat belt placement by the occupant. The seat belt still must be worn snugly and positioned properly.

The pretensioners are triggered by the Occupant Restraint Controller (ORC). Like the air bags, the pretensioners are single use items. A deployed pretensioner or a deployed air bag must be replaced immediately.

### Energy Management Feature

The front outboard seat belt system is equipped with an Energy Management feature that may help further reduce the risk of injury in the event of a collision. The seat belt system has a retractor assembly that is designed to release webbing in a controlled manner.

### Switchable Automatic Locking Retractor (ALR)

The seat belts in the passenger seating positions are equipped with a Switchable Automatic Locking Retractor (ALR) which is used to secure a child restraint system. The figure below illustrates the locking feature for each seating position  
 ⇨ page 322.

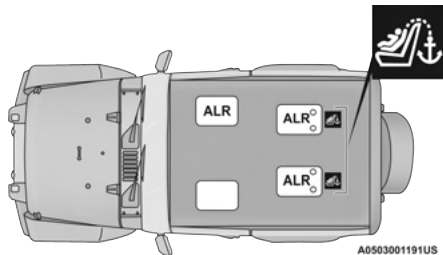

**ALR – Switchable Automatic Locking Retractor Locations  
(Two-Door Models)**

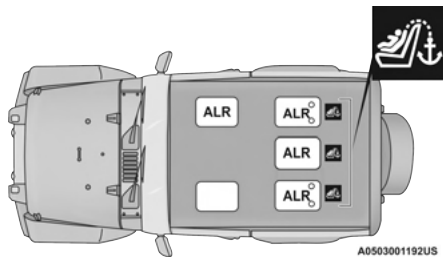

**ALR – Switchable Automatic Locking Retractor Locations  
(Four-Door Models)**

If the passenger seating position is equipped with an ALR and is being used for normal usage, only pull the seat belt webbing out far enough to comfortably wrap around the occupant's mid-section so as to not activate the ALR. If the ALR

is activated, you will hear a clicking sound as the seat belt retracts. Allow the webbing to retract completely in this case and then carefully pull out only the amount of webbing necessary to comfortably wrap around the occupant's mid-section. Slide the latch plate into the buckle until you hear a "click."

In Automatic Locking Mode, the shoulder belt is automatically pre-locked. The seat belt will still retract to remove any slack in the shoulder belt. Use the Automatic Locking Mode anytime a child restraint is installed in a seating position that has a seat belt with this feature. Children 12 years old and under should always be properly restrained in the rear seat of a vehicle with a rear seat.

#### WARNING!

- Never place a rear-facing child restraint in front of an air bag. A deploying passenger front air bag can cause death or serious injury to a child 12 years or younger, including a child in a rear-facing child restraint.
- Never install a rear-facing child restraint in the front seat of a vehicle. Only use a rear-facing child restraint in the rear seat. If the vehicle does not have a rear seat, do not transport a rear-facing child restraint in that vehicle.

#### How To Engage The Automatic Locking Mode

1. Buckle the combination lap and shoulder belt.
2. Grab the shoulder portion and pull downward until the entire seat belt is extracted.
3. Allow the seat belt to retract. As the seat belt retracts, you will hear a clicking sound. This indicates the seat belt is now in the Automatic Locking Mode.

#### How To Disengage The Automatic Locking Mode

Unbuckle the combination lap/shoulder belt and allow it to retract completely to disengage the Automatic Locking Mode and activate the vehicle sensitive (emergency) locking mode.

#### WARNING!

- The seat belt assembly must be replaced if the switchable Automatic Locking Retractor (ALR) feature or any other seat belt function is not working properly when checked according to the procedures in the Service Manual.
- Failure to replace the seat belt assembly could increase the risk of injury in collisions.

*(Continued)*

**WARNING!**

- Do not use the Automatic Locking Mode to restrain occupants who are wearing the seat belt or children who are using booster seats. The locked mode is only used to install rear-facing or forward-facing child restraints that have a harness for restraining the child.

## SUPPLEMENTAL RESTRAINT SYSTEMS (SRS)

Some of the safety features described in this section may be standard equipment on some models, or may be optional equipment on others. If you are not sure, ask an authorized dealer.

The air bag system must be ready to protect you in a collision. The Occupant Restraint Controller (ORC) monitors the internal circuits and interconnecting wiring associated with the electrical Air Bag System Components. Your vehicle may be equipped with the following Air Bag System Components:

### Air Bag System Components

- Occupant Restraint Controller (ORC)
- Air Bag Warning Light 
- Steering Wheel and Column
- Instrument Panel

- Knee Impact Bolsters
- Driver and Front Passenger Air Bags
- Seat Belt Buckle Switch
- Supplemental Side Air Bags
- Front and Side Impact Sensors
- Seat Belt Pretensioners
- Seat Track Position Sensors
- Occupant Classification System

### Air Bag Warning Light



The Occupant Restraint Controller (ORC) monitors the readiness of the electronic parts of the air bag system whenever the ignition switch is in the START or ON/RUN position. If the ignition switch is in the OFF position or in the ACC position, the air bag system is not on and the air bags will not inflate.

The ORC contains a backup power supply system that may deploy the air bag system even if the battery loses power or it becomes disconnected prior to deployment.

The ORC turns on the Air Bag Warning Light in the instrument panel for approximately four to eight seconds for a self-check when the ignition switch is first in the ON/RUN position. After the self-check, the Air Bag Warning Light will turn off. If the ORC detects a malfunction in any part of the system, it

turns on the Air Bag Warning Light, either momentarily or continuously. A single chime will sound to alert you if the light comes on again after initial startup.

The ORC also includes diagnostics that will illuminate the instrument panel Air Bag Warning Light if a malfunction is detected that could affect the air bag system. The diagnostics also record the nature of the malfunction. While the air bag system is designed to be maintenance free, if any of the following occurs, have an authorized dealer service the air bag system immediately.

- The Air Bag Warning Light does not come on during the four to eight seconds when the ignition switch is first in the ON/RUN position.
- The Air Bag Warning Light remains on after the four to eight-second interval.
- The Air Bag Warning Light comes on intermittently or remains on while driving.

### NOTE:

If the speedometer, tachometer, or any engine related gauges are not working, the Occupant Restraint Controller (ORC) may also be disabled. In this condition the air bags may not be ready to inflate for your protection. Have an authorized dealer service the air bag system immediately.



**WARNING!**

Ignoring the Air Bag Warning Light in your instrument panel could mean you won't have the air bag system to protect you in a collision. If the light does not come on as a bulb check when the ignition is first turned on, stays on after you start the vehicle, or if it comes on as you drive, have an authorized dealer service the air bag system immediately.

**Redundant Air Bag Warning Light**

If a fault with the Air Bag Warning Light is detected, which could affect the Supplemental Restraint System (SRS), the Redundant Air Bag Warning Light will illuminate on the instrument panel. The Redundant Air Bag Warning Light will stay on until the fault is cleared. In addition, a single chime will sound to alert you that the Redundant Air Bag Warning Light has come on and a fault has been detected. If the Redundant Air Bag Warning Light comes on intermittently or remains on while driving have an authorized dealer service the vehicle immediately → page 128.

**Front Air Bags**

This vehicle has front air bags and lap/shoulder belts for both the driver and front passenger. The front air bags are a supplement to the seat belt restraint systems. The driver front air bag is mounted in the center of the steering wheel. The passenger front air bag is mounted in the instrument panel, above the glove compartment. The words "SRS AIRBAG" or "AIRBAG" are embossed on the air bag covers.

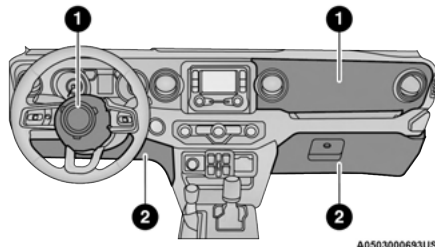

**Front Air Bag/Knee Impact Bolster Locations**

- 1 – Driver And Passenger Front Air Bags
- 2 – Driver And Passenger Knee Impact Bolsters

**WARNING!**

- Being too close to the steering wheel or instrument panel during front air bag deployment could cause serious injury, including death. Air bags need room to inflate. Sit back, comfortably extending your arms to reach the steering wheel or instrument panel.
- Never place a rear-facing child restraint in front of an air bag. A deploying passenger front air bag can cause death or serious injury to a child 12 years or younger, including a child in a rear-facing child restraint.
- Never install a rear-facing child restraint in the front seat of a vehicle. Only use a rear-facing child restraint in the rear seat. If the vehicle does not have a rear seat, do not transport a rear-facing child restraint in that vehicle.

**Driver And Passenger Front Air Bag Features**

The Advanced Front Air Bag system has multistage driver and front passenger air bags. This system provides output appropriate to the severity and type of collision as determined by the Occupant Restraint Controller (ORC), which may receive information from the front impact sensors (if equipped) or other system components.

The first stage inflator is triggered immediately during an impact that requires air bag deployment. A low energy output is used in less severe collisions. A higher energy output is used for more severe collisions.

This vehicle may be equipped with a driver and/or front passenger seat belt buckle switch that detects whether the driver or front passenger seat belt is buckled. The seat belt buckle switch may adjust the inflation rate of the Advanced Front Air Bags.

This vehicle may be equipped with driver and/or front passenger seat track position sensors that may adjust the inflation rate of the Advanced Front Air Bags based upon seat position.

This vehicle has an Occupant Classification System (OCS) in the front passenger seat. The OCS is designed to activate or deactivate the Passenger Advanced Front Air Bag depending on the occupant's seated weight. It is designed to deactivate the Passenger Advanced Front Air Bag for an unoccupied seat and for occupants whose seated weight classifies them in a category other than a properly seated adult. This could be a child, teenager, or even an adult.

The Passenger Air Bag Disable (PAD) Indicator Light (an amber light located on the overhead sports bar) tells the driver and front passenger when the Passenger Advanced Front Air Bag is deactivated. The PAD Indicator Light illuminates

the words "PASSENGER AIR BAG OFF" to show that the Passenger Advanced Front Air Bag will not deploy during a collision.

**NOTE:**

When the front passenger seat is empty or when very light objects are placed on the seat, the Passenger Advanced Front Air Bag will not deploy even though the Passenger Air Bag Disable (PAD) System Indicator Light is NOT illuminated.

**WARNING!**

- No objects should be placed over or near the air bag on the instrument panel or steering wheel because any such objects could cause harm if the vehicle is in a collision severe enough to cause the air bag to inflate.
- Do not put anything on or around the air bag covers or attempt to open them manually. You may damage the air bags and you could be injured because the air bags may no longer be functional. The protective covers for the air bag cushions are designed to open only when the air bags are inflating.
- Relying on the air bags alone could lead to more severe injuries in a collision. The air bags work with your seat belt to restrain you properly. In some collisions, air bags won't deploy at all. Always wear your seat belts even though you have air bags.

## Front Air Bag Operation

Front Air Bags are designed to provide additional protection by supplementing the seat belts. Front air bags are not expected to reduce the risk of injury in rear, side, or rollover collisions. The front air bags will not deploy in all frontal collisions, including some that may produce substantial vehicle damage — for example, some pole collisions, truck underrides, and angle offset collisions.

On the other hand, depending on the type and location of impact, front air bags may deploy in crashes with little vehicle front-end damage but that produce a severe initial deceleration.

Because air bag sensors measure vehicle deceleration over time, vehicle speed and damage by themselves are not good indicators of whether or not an air bag should have deployed.

Seat belts are necessary for your protection in all collisions, and also are needed to help keep you in position, away from an inflating air bag.

When the Occupant Restraint Controller (ORC) detects a collision requiring the front air bags, it signals the inflator units. A large quantity of non-toxic gas is generated to inflate the front air bags.

The steering wheel hub trim cover and the upper passenger side of the instrument panel separate and fold out of the way as the air bags inflate to



their full size. The front air bags fully inflate in less time than it takes to blink your eyes. The front air bags then quickly deflate while helping to restrain the driver and front passenger.

### Occupant Classification System (OCS) – Front Passenger Seat

The Occupant Classification System (OCS) is part of a Federally regulated safety system for this vehicle. It is designed to activate or deactivate the Passenger Advanced Front Air Bag depending on the occupant's seated weight. It is designed to deactivate the Passenger Advanced Front Air Bag for an unoccupied seat and for occupants whose seated weight classifies them in a category other than a properly seated adult. This could be a child, teenager, or even an adult.

#### The Occupant Classification System (OCS)

##### Consists Of The Following:

- Occupant Restraint Controller (ORC)
- Occupant Classification Module (OCM) and Sensor located in the front passenger seat
- Passenger Air Bag Disabled (PAD) Indicator Light – an amber light located on the overhead sports bar <sup>OFF</sup> 
- Air Bag Warning Light 
- Passenger Seat Belt

### Occupant Classification Module (OCM) And Sensor

The Occupant Classification Module (OCM) is located underneath the front passenger seat. The Sensor is located beneath the passenger seat cushion foam. Any weight on the seat will be sensed by the Sensor. The OCM uses input from the Sensor to determine the front passenger's most probable classification. The OCM communicates this information to the ORC. The ORC uses the classification to determine whether it should activate or deactivate the Passenger Advanced Front Air Bag. In order for the OCS to operate as designed, it is important for the front passenger to be seated properly and properly wearing the seat belt. Properly seated passengers are:

- Sitting upright
- Facing forward
- Sitting in the center of the seat with their feet comfortably on or near the floor
- Sitting with their back against the seat back and the seat back in an upright position

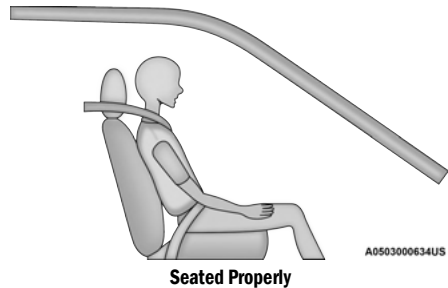

The OCS may deactivate the deployment of the Passenger Advanced Front Air Bag if the OCS estimates that:

- The front passenger seat is unoccupied or has very light objects in it.
- The front passenger seat is occupied by a rear-facing child restraint.
- The front passenger seat is occupied by a child, including a child seated in a forward-facing child restraint or booster seat.
- The front passenger seat is occupied by a small passenger, including a child or small adult.
- The front passenger is not properly seated or his or her weight is taken off of the seat for a period of time.

Passenger Air Bag Disable (PAD) System		
Front Passenger Seat Occupant Status	Front Passenger Advanced Air Bag Disabled Indicator Light ("PAD") Status	Front Passenger Air Bag Status
Unoccupied seat* Unbuckled	NOT ILLUMINATED	DEACTIVATED
Unoccupied seat*Buckled	"PASSENGER AIR BAG OFF"	DEACTIVATED
Grocery bags, heavy briefcases, and other relatively light objects	"PASSENGER AIR BAG OFF"	DEACTIVATED
Rear-facing child restraint**	"PASSENGER AIR BAG OFF"	DEACTIVATED
Child, including a child in a forward-facing child restraint or booster seat**	"PASSENGER AIR BAG OFF"	DEACTIVATED
Small adult	"PASSENGER AIR BAG OFF"	DEACTIVATED
Properly seated adult	NOT ILLUMINATED	ACTIVATED

\* When the front passenger seat is empty or when very light objects are placed on the seat and the seat belt is unbuckled, the Passenger Advanced Front Air Bag will not deploy even though the PAD System Indicator Light is NOT illuminated.

\*\* It is possible for a child to be classified as an adult, allowing the deployment of the Passenger Advanced Front Air Bag. Never allow children to ride in the front passenger seat and never install a child restraint system, including a rear-facing child restraint, in the front passenger seat.

#### WARNING!

- Never place a rear-facing child restraint in front of an air bag. A deploying passenger front air bag can cause death or serious injury to a child 12 years or younger, including a child in a rear-facing child restraint.
- Never install a rear-facing child restraint in the front seat of a vehicle. Only use a rear-facing child restraint in the rear seat. If the vehicle does not have a rear seat, do not transport a rear-facing child restraint in that vehicle.

### Passenger Advanced Front Air Bag Disabled (PAD) Indicator Light

The Passenger Advanced Front Air Bag Disabled (PAD) Indicator Light (an amber light located on the overhead sports bar) tells the driver and front passenger when the Passenger Advanced Front Air Bag is deactivated. The PAD Indicator light illuminates the words "PASSENGER AIR BAG OFF" to show that the Passenger Advanced Front Air Bag will not deploy during a collision. When the front passenger seat is empty or when very light objects are placed on the seat and the seat belt is unbuckled, the Passenger Advanced Front Air Bag will not deploy even though the PAD indicator light is NOT illuminated.

The PAD indicator light should not be illuminated when an adult passenger is properly seated in the front passenger seat. The driver and adult passenger should verify that the PAD Indicator Light is not illuminated when an adult is riding in the front passenger seat. If an adult is not seated properly, the Passenger Advanced Front Air Bag may deactivate and the PAD Indicator Light will be illuminated.

The PAD Indicator Light should be illuminated and the Passenger Advanced Front Air Bag should be deactivated for most properly seated and restrained children in the passenger seat and for most properly installed child restraint systems. However, under certain conditions, even with a properly installed

child restraint system, the PAD Indicator Light may not be illuminated, even though the Passenger Advanced Front Air Bag is deactivated. This can occur if the child restraint is lighter than the lightest weight necessary to illuminate the PAD Indicator Light. **NEVER** assume the Passenger Advanced Front Air Bag is deactivated unless the PAD Indicator Light is illuminated with the words "PASSENGER AIR BAG OFF."

#### NOTE:

If the seat belt is buckled for an empty seat, the PAD Indicator Light will illuminate.

#### If The PAD Indicator Light Is Illuminated For An Adult Passenger:

If an adult passenger is seated in the front passenger seat and the PAD Indicator Light is illuminated, the passenger may be sitting improperly. Follow the steps below to allow the OCS to detect the adult passenger's seated weight to activate the Passenger Advanced Front Air Bag:

1. Turn off the vehicle and have the adult passenger step out of the vehicle.
2. Remove any extra materials from the passenger seat, such as cushions, pads, seat covers, seat massagers, blankets, extra clothing, etc.
3. Place the seatback in the full upright position.
4. Have the adult passenger sit in the center of the seat, with the passenger's feet

comfortably on or near the floor, and with their back against the seatback.

5. Restart the vehicle and have the passenger remain in this seated position for two to three minutes after restarting the vehicle.

#### WARNING!

- If the PAD Indicator Light remains illuminated for an adult passenger, have an authorized dealer service the air bag system immediately. Failure to do so may cause serious injury or death. If the PAD Indicator Light is illuminated with the words "PASSENGER AIR BAG OFF," the Passenger Advanced Front Air Bag will not deploy in the event of a collision.
- Never place a rear-facing child restraint in front of an air bag. A deploying passenger front air bag can cause death or serious injury to a child 12 years or younger, including a child in a rear-facing child restraint.
- Never install a rear-facing child restraint in the front seat of a vehicle. Only use a rear-facing child restraint in the rear seat. If the vehicle does not have a rear seat, do not transport a rear-facing child restraint in that vehicle.
- Children 12 years or younger should always ride buckled up in the rear seat of a vehicle with a rear seat.

### Lighter Weight Passengers (Including Small Adults)

When a lighter weight passenger, including a small adult, occupies the passenger seat, the Passenger Advanced Front Air Bag may be deactivated.

Therefore, the Passenger Advanced Front Air Bag may or may not be activated for a lighter weight passenger, including a small adult (depending on size) who is seated in the passenger seat. This does not mean that the OCS is working improperly.

The driver and passenger must always use the PAD Indicator Light as a determination of whether the Passenger Advanced Front Air Bag is activated or deactivated. If the PAD Indicator Light is illuminated with the words "PASSENGER AIR BAG OFF" when an adult is in the front passenger seat, have the passenger reposition his or her body in the seat until the PAD Indicator Light goes out.

If the PAD Indicator Light is illuminated with the words "PASSENGER AIR BAG OFF" the Passenger Advanced Front Air Bag will not inflate in the event of a collision.

### Do Not Decrease OR Increase The Front Passenger's Seated Weight On The Front Passenger Seat

The front passenger's seated weight must be properly positioned on the front passenger seat. Failure to do so may result in serious injury or death. The OCS determines the most probable classification of the occupant that it detects. The OCS will detect the front passenger's decreased or

increased seated weight, which may result in deactivation or activation of the Passenger Advanced Front Air Bag in a collision. This does not mean that the OCS is working improperly. Decreasing the front passenger's seated weight on the front passenger seat may result in deactivation of the Passenger Advanced Front Air Bag causing serious injury or death. Increasing the front passenger's seated weight on the front passenger seat may result in activation of the Passenger Advanced Front Air Bag. Examples of improper front passenger seating include:

- The front passenger's weight is transferred to another part of the vehicle (like the door, arm rest or instrument panel).
- The front passenger leans forward, sideways, or turns to face the rear of the vehicle.
- The front passenger's seatback is not in the full upright position.
- The front passenger carries or holds an object while seated (e.g., backpack, box, etc.).
- Objects are lodged under the front passenger seat.
- Objects are lodged between the front passenger seat and center console.

- Accessories that may change the seated weight on the front passenger seat are attached to the front passenger seat.
- Anything that may decrease or increase the front passenger's seated weight.

The OCS determines the front passenger's most probable classification. If an occupant in the front passenger seat is seated improperly, the occupant may provide an output signal to the OCS that is different from the occupant's properly seated weight input, for example:

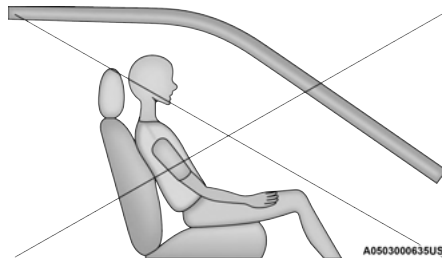

Not Seated Properly

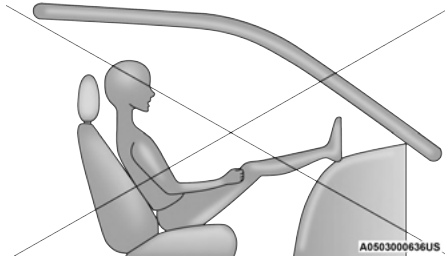

Not Seated Properly

A0503000636US

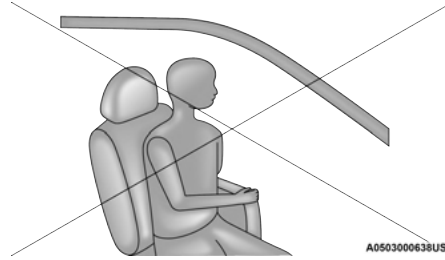

Not Seated Properly

A0503000638US

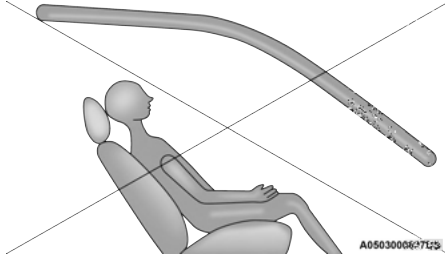

Not Seated Properly

A0503000637US

**WARNING!**

- If a child restraint system, child, small teenager or adult in the front passenger seat is seated improperly, the occupant may provide an output signal to the OCS that is different from the occupant's properly seated weight input. This may result in serious injury or death in a collision.

*(Continued)***WARNING!**

- Always wear your seat belt and sit properly, with the seatback in an upright position, your back against the seatback, sitting upright, facing forward, in the center of the seat, with your feet comfortably on or near the floor.
- Do not carry or hold any objects (e.g., backpacks, boxes, etc.) while seated in the front passenger seat. Holding an object may provide an output signal to the OCS that is different than the occupant's properly seated weight input, which may result in serious injury or death in a collision.

The Air Bag Warning Light  will illuminate whenever the OCS is unable to classify the front passenger seat status.

A malfunction in the OCS may affect the operation of the air bag system. If the Air Bag Warning Light  does not come on, or stays on after you start the vehicle, or it comes on as you drive, take the vehicle to an authorized dealer for service immediately.

**WARNING!**

- Ignoring the Air Bag Warning Light in your instrument panel could mean you won't have the air bags to protect you in a collision. If the light does not come on as a bulb check when the ignition is first turned on, stays on after you start the vehicle, or if it comes on as you drive, have an authorized dealer service the air bag system immediately.
- Placing an object on the floor under the front passenger seat may prevent the OCS from working properly, which may result in serious injury or death in a collision. Do not place any objects on the floor under the front passenger seat.
- If there is a fault present in the OCS, both the PAD Indicator Light and the Air Bag Warning Light will illuminate to show that the Passenger Advanced Front Air Bag is deactivated. Should this occur, the Passenger Advanced Front Air Bag will remain deactivated until the fault is cleared. This indicates that you should take the vehicle to an authorized dealer for service immediately.

The passenger seat assembly contains critical OCS components that may affect Passenger Advanced Front Air Bag inflation. In order for the OCS to properly classify the seated weight of a front seat

passenger, the OCS components must function as designed. Do not make any modifications to the front passenger seat components, assembly, or to the seat cover. If the seat, trim cover, or cushion needs service for any reason, take the vehicle to an authorized dealer. Only FCA US LLC approved seat accessories may be used.

The following requirements must be strictly followed:

- Do not modify the front passenger seat assembly or components in any way.
- Do not use prior or future model year seat covers or cushions not designated by FCA US LLC for the specific model being repaired. Always use the correct seat cover and cushion specified for the vehicle.
- Do not replace the seat cover or cushion with an aftermarket seat cover or cushion.
- Do not add a secondary seat cover or mat.
- At no time should any Supplemental Restraint System (SRS) component or SRS related component or fastener be modified or replaced with any part except those which are approved by FCA US LLC.

**WARNING!**

- Unapproved modifications or service procedures to the passenger seat assembly, its related components, seat cover, or cushion may inadvertently change the air bag deployment in case of a frontal collision. This could result in death or serious injury to the front passenger if the vehicle is involved in a collision. A modified vehicle may not comply with required Federal Motor Vehicle Safety Standards (FMVSS) and/or Canadian Motor Vehicle Safety Standards (CMVSS).
- If it is necessary to modify the air bag system for persons with disabilities, contact an authorized dealer.

**Knee Impact Bolsters**

The Knee Impact Bolsters help protect the knees of the driver and front passenger, and position the front occupants for improved interaction with the front air bags.

**WARNING!**

- Do not drill, cut, or tamper with the knee impact bolsters in any way.
- Do not mount any accessories to the knee impact bolsters such as alarm lights, stereos, citizen band radios, etc.



## Supplemental Side Air Bags

### Supplemental Seat-Mounted Side Air Bags (SABs)

This vehicle is equipped with Supplemental Seat-Mounted Side Air Bags (SABs).

Supplemental Seat-Mounted Side Air Bags (SABs) are located in the outboard side of the front seats. The SABs are marked with a “SRS AIRBAG” or “AIRBAG” on a label or on the seat trim on the outboard side of the seats.

The SABs may help to reduce the risk of occupant injury during certain side impacts, in addition to the injury reduction potential provided by the seat belts and body structure.

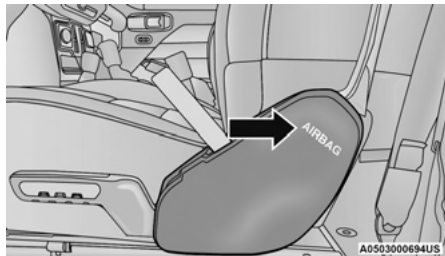

**Supplemental Seat-Mounted Side Air Bag Label**

When the SAB deploys, it opens the seam on the outboard side of the seatback's trim cover. The inflating SAB deploys through the seat seam into the space between the occupant and the door. The

SAB moves at a very high speed and with such a high force that it could injure occupants if they are not seated properly, or if items are positioned in the area where the SAB inflates. Children are at an even greater risk of injury from a deploying air bag.

#### WARNING!

Do not use accessory seat covers or place objects between you and the Side Air Bags; the performance could be adversely affected and/or objects could be pushed into you, causing serious injury.

### Side Impacts

The Side Air Bags are designed to activate in certain side impacts. The Occupant Restraint Controller (ORC) determines whether the deployment of the Side Air Bags in a particular impact event is appropriate, based on the severity and type of collision. The side impact sensors aid the ORC in determining the appropriate response to impact events. The system is calibrated to deploy the Side Air Bags on the impact side of the vehicle during impacts that require Side Air Bag occupant protection. In side impacts, the Side Air Bags deploy independently; a left side impact deploys the left Side Air Bags only and a right-side impact deploys the right Side Air Bags only. Vehicle damage by itself is not a good indicator of whether or not Side Air Bags should have deployed.

The Side Air Bags will not deploy in all side collisions, including some collisions at certain angles, or some side collisions that do not impact the area of the passenger compartment. The Side Air Bags may deploy during angled or offset frontal collisions where the front air bags deploy.

Side Air Bags are a supplement to the seat belt restraint system. Side Air Bags deploy in less time than it takes to blink your eyes.

#### WARNING!

- Occupants, including children, who are up against or very close to Side Air Bags can be seriously injured or killed. Occupants, including children, should never lean on or sleep against the door, side windows, or area where the side air bags inflate, even if they are in an infant or child restraint.
- Seat belts (and child restraints where appropriate) are necessary for your protection in all collisions. They also help keep you in position, away from an inflating Side Air Bag. To get the best protection from the Side Air Bags, occupants must wear their seat belts properly and sit upright with their backs against the seats. Children must be properly restrained in a child restraint or booster seat that is appropriate for the size of the child.

**WARNING!**

- Side Air Bags need room to inflate. Do not lean against the door or window. Sit upright in the center of the seat.
- Being too close to the Side Air Bags during deployment could cause you to be severely injured or killed.
- Relying on the Side Air Bags alone could lead to more severe injuries in a collision. The Side Air Bags work with your seat belt to restrain you properly. In some collisions, Side Air Bags won't deploy at all. Always wear your seat belt even though you have Side Air Bags.

**NOTE:**

Air bag covers may not be obvious in the interior trim, but they will open during air bag deployment.

**Air Bag System Components****NOTE:**

The Occupant Restraint Controller (ORC) monitors the internal circuits and interconnecting wiring associated with electrical Air Bag System Components listed below:

- Occupant Restraint Controller (ORC)
- Air Bag Warning Light 
- Steering Wheel and Column
- Instrument Panel

- Knee Impact Bolsters
- Driver and Front Passenger Air Bags
- Seat Belt Buckle Switch
- Supplemental Side Air Bags
- Front and Side Impact Sensors
- Seat Belt Pretensioners
- Seat Track Position Sensors
- Occupant Classification System

**If A Deployment Occurs**

The front air bags are designed to deflate immediately after deployment.

**NOTE:**

Front and/or side air bags will not deploy in all collisions. This does not mean something is wrong with the air bag system.

If you do have a collision which deploys the air bags, any or all of the following may occur:

- The air bag material may sometimes cause abrasions and/or skin reddening to the occupants as the air bags deploy and unfold. The abrasions are similar to friction rope burns or those you might get sliding along a carpet or gymnasium floor. They are not caused by contact with chemicals. They are not permanent and normally heal quickly. However, if you haven't healed significantly within a few days, or if you have any blistering, see your doctor immediately.

- As the air bags deflate, you may see some smoke-like particles. The particles are a normal by-product of the process that generates the non-toxic gas used for air bag inflation. These airborne particles may irritate the skin, eyes, nose, or throat. If you have skin or eye irritation, rinse the area with cool water. For nose or throat irritation, move to fresh air. If the irritation continues, see your doctor. If these particles settle on your clothing, follow the garment manufacturer's instructions for cleaning.

Do not drive your vehicle after the air bags have deployed. If you are involved in another collision, the air bags will not be in place to protect you.

**WARNING!**

Deployed air bags and seat belt pretensioners cannot protect you in another collision. Have the air bags, seat belt pretensioners, and the seat belt retractor assemblies replaced by an authorized dealer immediately. Also, have the Occupant Restraint Controller System serviced as well.

**NOTE:**

- Air bag covers may not be obvious in the interior trim, but they will open during air bag deployment.
- After any collision, the vehicle should be taken to an authorized dealer immediately.

## Enhanced Accident Response System

In the event of an impact, if the communication network remains intact, and the power remains intact, depending on the nature of the event, the Occupant Restraint Controller (ORC) will determine whether to have the Enhanced Accident Response System perform the following functions:

- Cut off fuel to the engine (if equipped).
- Cut off battery power to the electric motor (if equipped).
- Flash hazard lights as long as the battery has power.
- Turn on the interior lights, which remain on as long as the battery has power or for 15 minutes from the intervention of the Enhanced Accident Response System.
- Unlock the power door locks.

Your vehicle may also be designed to perform any of these other functions in response to the Enhanced Accident Response System:

- Turn off the Fuel Filter Heater, Turn off the HVAC Blower Motor, Close the HVAC Circulation Door
- Cut off battery power to the:
  - Engine
  - Electric Motor (if equipped)
  - Electric power steering
  - Brake booster

- Electric park brake
- Automatic transmission gear selector
- Horn
- Front wiper
- Headlamp washer pump (if equipped)

### NOTE:

After an accident, remember to cycle the ignition to the START or ON/OFF position and remove the key from the ignition switch to avoid draining the battery. Carefully check the vehicle for fuel leaks in the engine compartment and on the ground near the engine compartment and fuel tank before resetting the system and starting the engine. If there are no fuel leaks or damage to the vehicle electrical devices (e.g. headlights) after an accident, reset the system by following the procedure described below. If you have any doubt, contact an authorized dealer.

## Enhanced Accident Response System Reset Procedure

**If applicable, refer to the “Hybrid Supplement” for additional information.**

In order to reset the Enhanced Accident Response System functions after an event, the ignition switch must be changed from ignition START or ON/RUN to ignition OFF. Carefully check the vehicle for fuel leaks in the engine compartment and on the

ground near the engine compartment and fuel tank before resetting the system and starting the engine.

After an accident, if the vehicle will not start after performing the reset procedure, the vehicle must be towed to an authorized dealer to be inspected and to have the Enhanced Accident Response System reset.

## Maintaining Your Air Bag System

### WARNING!

- Modifications to any part of the air bag system could cause it to fail when you need it. You could be injured if the air bag system is not there to protect you. Do not modify the components or wiring, including adding any kind of badges or stickers to the steering wheel hub trim cover or the upper passenger side of the instrument panel. Do not modify the front fascia/bumper, vehicle body structure, or add aftermarket side steps or running boards.
- It is dangerous to try to repair any part of the air bag system yourself. Be sure to tell anyone who works on your vehicle that it has an air bag system.

*(Continued)*

**WARNING!**

- Do not attempt to modify any part of your air bag system. The air bag may inflate accidentally or may not function properly if modifications are made. Take your vehicle to an authorized dealer for any air bag system service. If your seat, including your trim cover and cushion, needs to be serviced in any way (including removal or loosening/tightening of seat attachment bolts), take the vehicle to an authorized dealer. Only manufacturer approved seat accessories may be used. If it is necessary to modify the air bag system for persons with disabilities, contact an authorized dealer.

**Event Data Recorder (EDR)**

This vehicle is equipped with an event data recorder (EDR). The main purpose of an EDR is to record, in certain crash or near crash-like situations, such as an air bag deployment or hitting a road obstacle, data that will assist in understanding how a vehicle's systems performed. The EDR is designed to record data related to vehicle dynamics and safety systems for a short period of time, typically 30 seconds or less. The EDR in this vehicle is designed to record such data as:

- How various systems in your vehicle were operating;
- Whether or not the driver and passenger safety belts were buckled/fastened;
- How far (if at all) the driver was depressing the accelerator and/or brake pedal; and,
- How fast the vehicle was traveling.

These data can help provide a better understanding of the circumstances in which crashes and injuries occur.

**NOTE:**

EDR data are recorded by your vehicle only if a non-trivial crash situation occurs; no data are recorded by the EDR under normal driving conditions and no personal data (e.g., name, gender, age, and crash location) are recorded. However, other parties, such as law enforcement, could combine the EDR data with the type of personally identifying data routinely acquired during a crash investigation.

To read data recorded by an EDR, special equipment is required, and access to the vehicle or the EDR is needed. In addition to the vehicle manufacturer, other parties, such as law enforcement, that have the special equipment, can read the information if they have access to the vehicle or the EDR.

**CHILD RESTRAINTS**

Everyone in your vehicle needs to be buckled up at all times, including babies and children. Every state in the United States, and every Canadian province, requires that small children ride in proper restraint systems. This is the law, and you can be prosecuted for ignoring it.

Children 12 years or younger should ride properly buckled up in a rear seat, if available. According to crash statistics, children are safer when properly restrained in the rear seats rather than in the front.

**WARNING!**

In a collision, an unrestrained child can become a projectile inside the vehicle. The force required to hold even an infant on your lap could become so great that you could not hold the child, no matter how strong you are. The child and others could be badly injured or killed. Any child riding in your vehicle should be in a proper restraint for the child's size.

There are different sizes and types of restraints for children from newborn size to the child almost large enough for an adult safety belt. Always check the child seat Owner's Manual to make sure you have the correct seat for your child. Carefully read and follow all the instructions and warnings in the child restraint Owner's Manual and on all the labels attached to the child restraint.

Before buying any restraint system, make sure that it has a label certifying that it meets all applicable Safety Standards. You should also make sure that you can install it in the vehicle where you will use it.

**NOTE:**

- For additional information, refer to <http://www.nhtsa.gov/parents-and-caregivers> or call: 1-888-327-4236
- Canadian residents should refer to Transport Canada's website for additional information: <https://www.tc.gc.ca/en/services/road/child-car-seat-safety.html>

### Summary Of Recommendations For Restraining Children In Vehicles

	Child Size, Height, Weight Or Age	Recommended Type Of Child Restraint
Infants and Toddlers	Children who are two years old or younger and who have not reached the height or weight limits of their child restraint	Either an Infant Carrier or a Convertible Child Restraint, facing rearward in a rear seat of the vehicle
Small Children	Children who are at least two years old or who have outgrown the height or weight limit of their rear-facing child restraint	Forward-Facing Child Restraint with a five-point Harness, facing forward in a rear seat of the vehicle
Larger Children	Children who have outgrown their forward-facing child restraint, but are too small to properly fit the vehicle's seat belt	Belt Positioning Booster Seat and the vehicle seat belt, seated in a rear seat of the vehicle
Children Too Large for Child Restraints	Children 12 years old or younger, who have outgrown the height or weight limit of their booster seat	Vehicle Seat Belt, seated in a rear seat of the vehicle

## Infant And Child Restraints

Safety experts recommend that children ride rear-facing in the vehicle until they are two years old or until they reach either the height or weight limit of their rear-facing child restraint. Two types of child restraints can be used rear-facing: infant carriers and convertible child seats.

The infant carrier is only used rear-facing in the vehicle. It is recommended for children from birth until they reach the weight or height limit of the infant carrier. Convertible child seats can be used either rear-facing or forward-facing in the vehicle. Convertible child seats often have a higher weight limit in the rear-facing direction than infant carriers do, so they can be used rear-facing by children who have outgrown their infant carrier but are still less than at least two years old. Children should remain rear-facing until they reach the highest weight or height allowed by their convertible child seat.

### WARNING!

- Never place a rear-facing child restraint in front of an air bag. A deploying passenger front air bag can cause death or serious injury to a child 12 years or younger, including a child in a rear-facing child restraint.

*(Continued)*

### WARNING!

- Never install a rear-facing child restraint in the front seat of a vehicle. Only use a rear-facing child restraint in the rear seat. If the vehicle does not have a rear seat, do not transport a rear-facing child restraint in that vehicle.

## Older Children And Child Restraints

Children who are two years old or who have outgrown their rear-facing convertible child seat can ride forward-facing in the vehicle.

Forward-facing child seats and convertible child seats used in the forward-facing direction are for children who are over two years old or who have outgrown the rear-facing weight or height limit of their rear-facing convertible child seat. Children should remain in a forward-facing child seat with a harness for as long as possible, up to the highest weight or height allowed by the child seat.

All children whose weight or height is above the forward-facing limit for the child seat should use a belt-positioning booster seat until the vehicle's seat belts fit properly. If the child cannot sit with knees bent over the vehicle's seat cushion while the child's back is against the seatback, they

should use a belt-positioning booster seat. The child and belt-positioning booster seat are held in the vehicle by the seat belt.

### WARNING!

- Improper installation can lead to failure of an infant or child restraint. It could come loose in a collision. The child could be badly injured or killed. Follow the child restraint manufacturer's directions exactly when installing an infant or child restraint.
- After a child restraint is installed in the vehicle, do not move the vehicle seat forward or rearward because it can loosen the child restraint attachments. Remove the child restraint before adjusting the vehicle seat position. When the vehicle seat has been adjusted, reinstall the child restraint.
- When your child restraint is not in use, secure it in the vehicle with the seat belt or LATCH anchorages, or remove it from the vehicle. Do not leave it loose in the vehicle. In a sudden stop or accident, it could strike the occupants or seatbacks and cause serious personal injury.

## Children Too Large For Booster Seats

Children who are large enough to wear the shoulder belt comfortably, and whose legs are long enough to bend over the front of the seat when their back is against the seatback, should use the seat belt in a rear seat. Use this simple 5-step test to decide whether the child can use the vehicle's seat belt alone:

1. Can the child sit all the way back against the back of the vehicle seat?
2. Do the child's knees bend comfortably over the front of the vehicle seat while the child is still sitting all the way back?

3. Does the shoulder belt cross the child's shoulder between the neck and arm?
4. Is the lap part of the belt as low as possible, touching the child's thighs and not the stomach?
5. Can the child stay seated like this for the whole trip?

If the answer to any of these questions was "no", then the child still needs to use a booster seat in this vehicle. If the child is using the lap/shoulder belt, check seat belt fit periodically and make sure the seat belt buckle is latched. A child's squirming or slouching can move the belt out of position. If

the shoulder belt contacts the face or neck, move the child closer to the center of the vehicle, or use a booster seat to position the seat belt on the child correctly.

### WARNING!

Never allow a child to put the shoulder belt under an arm or behind their back. In a crash, the shoulder belt will not protect a child properly, which may result in serious injury or death. A child must always wear both the lap and shoulder portions of the seat belt correctly.

## Recommendations For Attaching Child Restraints

Restraint Type	Combined Weight of the Child + Child Restraint	Use Any Attachment Method Shown With An "X" Below			
		LATCH – Lower Anchors Only	Seat Belt Only	LATCH – Lower Anchors + Top Tether Anchor	Seat Belt + Top Tether Anchor
Rear-Facing Child Restraint	Up to 65 lbs (29.5 kg)	X	X		
Rear-Facing Child Restraint	More than 65 lbs (29.5 kg)		X		
Forward-Facing Child Restraint	Up to 65 lbs (29.5 kg)			X	X
Forward-Facing Child Restraint	More than 65 lbs (29.5 kg)				X

## Lower Anchors And Tethers For Children (LATCH) Restraint System



022668173



### LATCH Label

Your vehicle is equipped with the child restraint anchorage system called LATCH, which stands for Lower Anchors and Tethers for Children. The LATCH system has three vehicle anchor points for installing LATCH-equipped child seats. There are two lower anchorages located at the back of the seat cushion where it meets the seatback and one top tether anchorage located behind the seating position. These anchorages are used to install LATCH-equipped child seats without using the vehicle's seat belts. Some seating positions may have a top tether anchorage but no lower anchorages. In these seating positions, the seat belt must be used with the top tether anchorage to install the child restraint. Please see the following table for more information.

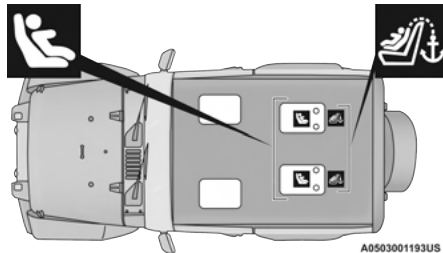
## LATCH Positions For Installing Child Restraints In This Vehicle



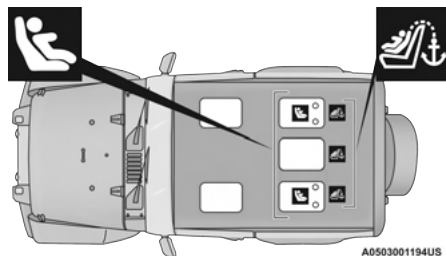

### LATCH Positions (Two-Door Models)

-  Lower Anchorage Symbol  
(2 Anchorages Per Seating Position)
-  Top Tether Anchorage Symbol



### LATCH Positions (Four-Door Models)

-  Lower Anchorage Symbol  
(2 Anchorages Per Seating Position)
-  Top Tether Anchorage Symbol



### Frequently Asked Questions About Installing Child Restraints With LATCH

What is the weight limit (child's weight + weight of the child restraint) for using the LATCH anchorage system to attach the child restraint?	65 lbs (29.5 kg)	Use the LATCH anchorage system until the combined weight of the child and the child restraint is 65 lbs (29.5 kg). Use the seat belt and tether anchor instead of the LATCH system once the combined weight is more than 65 lbs (29.5 kg).
Can the LATCH anchorages and the seat belt be used together to attach a rear-facing or forward-facing child restraint?	No	Do not use the seat belt when you use the LATCH anchorage system to attach a rear-facing or forward-facing child restraint. Booster seats may be attached to the LATCH anchorages if allowed by the booster seat manufacturer. See your booster seat owner's manual for more information.
Can a child seat be installed in the center position using the inner LATCH lower anchorages from the outboard seating positions?	Two Door Models – No Center Seating Position Four Door Models – Yes	Four Door Only: You can install child restraints with flexible lower anchors in the center position. The inner anchorages are 18.5 inches (484 mm) apart. Do not install child restraints with rigid lower anchors in the center position.
Can two child restraints be attached using a common lower LATCH anchorage?	No	Never "share" a LATCH anchorage with two or more child restraints. If the center position does not have dedicated LATCH lower anchorages, use the seat belt to install a child seat in the center position next to a child seat using the LATCH anchorages in an outboard position.
Can the rear-facing child restraint touch the back of the front passenger seat?	Yes	The child seat may touch the back of the front passenger seat if the child restraint manufacturer also allows contact. See your child restraint owner's manual for more information.
Can the rear head restraints be removed?	Two Door Models – No Four Door Models – Yes	Two Door Models – None Four Door – The center head restraint can be removed if it interferes with the installation of the child restraint. For further information, see ⇨ page 48.

**NOTE:**

If the folding, non-adjustable head restraint interferes with the installation of the child restraint, the head restraint may be folded and the child seat installed in front of it (Two-Door Models).

**WARNING!**

Always make sure the head restraint is in its upright position when the seat is to be used by an occupant who is not in a child restraint. Sitting in a seat with the head restraint in its lowered position could result in serious injury or death in a collision.

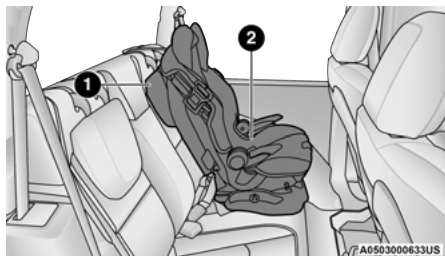
**Car Seat With Head Restraint Folded**

- 1 — Folded Headrest
- 2 — Child Restraint

**Locating The LATCH Anchorages**

The lower anchorages are round bars that are found at the rear of the seat cushion where it meets the seatback.

They are just visible when you lean into the rear seat to install the child restraint. You will easily feel them if you run your finger along the gap between the seatback and seat cushion. If your vehicle is equipped with anchorage symbols on the seatback, they will be located just above the lower anchorages.

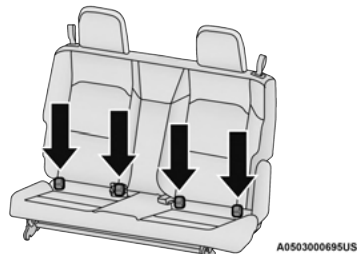
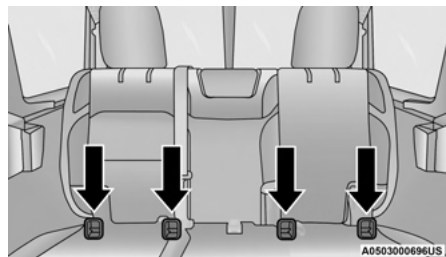
**LATCH Anchorages (Two-Door Models)****LATCH Anchorages (Four-Door Models)****Locating The Upper Tether Anchorages****Two-Door Models:**

There are tether strap anchorages behind each rear seating position located on the back of the seat, near the floor.

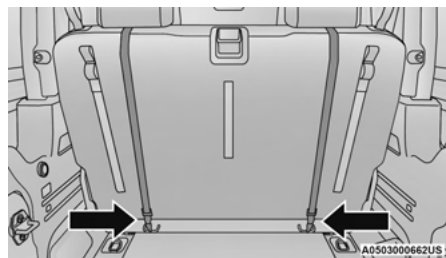
**Tether Strap Anchorages (Two-Door Models)**

**Four-Door Models:**

There are tether strap anchorages behind each rear seating position located on the back of the seat.

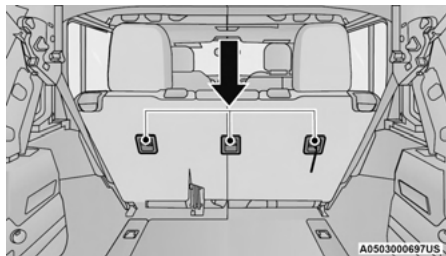

**Tether Strap Anchorages (Four-Door Models)**

LATCH-compatible child restraint systems will be equipped with a rigid bar or a flexible strap on each side. Each will have a hook or connector to attach to the lower anchorage and a way to tighten the connection to the anchorage. Forward-facing child restraints and some rear-facing child restraints will also be equipped with a tether strap. The tether strap will have a hook at the end to attach to the top tether anchorage and a way to tighten the strap after it is attached to the anchorage.

**Center Seat LATCH****Two-Door Models:****WARNING!**

This vehicle does not have a center seating position. Do not use the center lower LATCH anchorages to install a child seat in the center of the back seat.

**Four-Door Models:**

Do not install child restraints with rigid lower attachments in the center seating position. Only install this type of child restraint in the outboard seating positions. Child restraints with flexible, webbing mounted lower attachments can be installed in any rear seating position.

**WARNING!**

Never use the same lower anchorage to attach more than one child restraint. If you are installing LATCH-compatible child restraints next to each other, you must use the seat belt for the center position. You can then use either the LATCH anchors or the vehicle's seat belt for installing child seats in the outboard positions.

Please see ⇨ page 321 for typical installation instructions.

Always follow the directions of the child restraint manufacturer when installing your child restraint. Not all child restraint systems will be installed as described here.

**To Install A LATCH-Compatible Child Restraint**

If the selected seating position has a Switchable Automatic Locking Retractor (ALR) seat belt, stow the seat belt, following the instructions below. See ⇨ page 322 to check what type of seat belt each seating position has.

1. Loosen the adjusters on the lower straps and on the tether strap of the child seat so that you can more easily attach the hooks or connectors to the vehicle anchorages.
2. Place the child seat between the lower anchorages for that seating position. If the second row seat can be reclined, you may recline the seat and/or raise the head restraint (if adjustable) to get a better fit. If the rear seat can be moved forward and rearward in the vehicle, you may wish to move it to its rear-most position to make room for the child seat. You may also move the front seat forward to allow more room for the child seat.

3. Attach the lower hooks or connectors of the child restraint to the lower anchorages in the selected seating position.
4. If the child restraint has a tether strap, connect it to the top tether anchorage. See [↪ page 325](#) for directions to attach a tether anchor.
5. Tighten all of the straps as you push the child restraint rearward and downward into the seat. Remove slack in the straps according to the child restraint manufacturer's instructions.
6. Test that the child restraint is installed tightly by pulling back and forth on the child seat at the belt path. It should not move more than 1 inch (25.4 mm) in any direction.

### How To Stow An Unused Switchable-ALR (ALR) Seat Belt:

When using the LATCH attaching system to install a child restraint, stow all ALR seat belts that are not being used by other occupants or being used to secure child restraints. An unused belt could injure a child if they play with it and accidentally lock the seat belt retractor. Before installing a child restraint using the LATCH system, buckle the seat belt behind the child restraint and out of the child's reach. If the buckled seat belt interferes with the

child restraint installation, instead of buckling it behind the child restraint, route the seat belt through the child restraint belt path and then buckle it. Do not lock the seat belt. Remind all children in the vehicle that the seat belts are not toys and that they should not play with them.

#### WARNING!

- Improper installation of a child restraint to the LATCH anchorages can lead to failure of the restraint. The child could be badly injured or killed. Follow the child restraint manufacturer's directions exactly when installing an infant or child restraint.
- Child restraint anchorages are designed to withstand only those loads imposed by correctly-fitted child restraints. Under no circumstances are they to be used for adult seat belts, harnesses, or for attaching other items or equipment to the vehicle.

### Installing Child Restraints Using The Vehicle Seat Belt

Child restraint systems are designed to be secured in vehicle seats by lap belts or the lap belt portion of a lap/shoulder belt.

#### WARNING!

- Improper installation or failure to properly secure a child restraint can lead to failure of the restraint. The child could be badly injured or killed.
- Follow the child restraint manufacturer's directions exactly when installing an infant or child restraint.

The seat belts in the passenger seating positions are equipped with a Switchable Automatic Locking Retractor (ALR) that is designed to keep the lap portion of the seat belt tight around the child restraint so that it is not necessary to use a locking clip. The ALR retractor can be "switched" into a locked mode by pulling all of the webbing out of the retractor and then letting the webbing retract back into the retractor. If it is locked, the ALR will make a clicking noise while the webbing is pulled back into the retractor.

Refer to the "Automatic Locking Mode" description in "Switchable Automatic Locking Retractors (ALR)" [↪ page 300](#) for additional information on ALR.

Please see the table below and the following sections for more information.

## Lap/Shoulder Belt Systems For Installing Child Restraints In This Vehicle

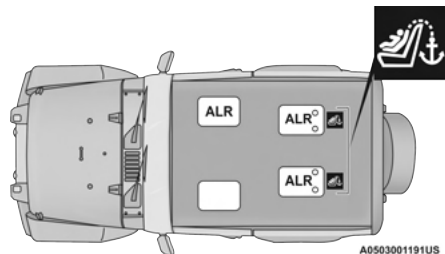

**Automatic Locking Retractor Locations  
(Two-Door Models)**

ALR — Switchable Automatic Locking Retractor  
 Top Tether Anchorage Symbol

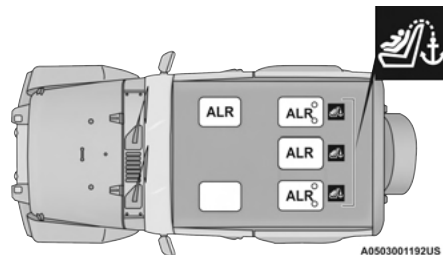

**Automatic Locking Retractor Locations  
(Four-Door Models)**

ALR — Switchable Automatic Locking Retractor  
 Top Tether Anchorage Symbol

### Frequently Asked Questions About Installing Child Restraints With Seat Belts

What is the weight limit (child's weight + weight of the child restraint) for using the Tether Anchor with the seat belt to attach a forward facing child restraint?	Weight limit of the Child Restraint	Always use the tether anchor when using the seat belt to install a forward facing child restraint, up to the recommended weight limit of the child restraint.
Can the rear-facing child restraint touch the back of the front passenger seat?	Yes	Contact between the front passenger seat and the child restraint is allowed, if the child restraint manufacturer also allows contact.
Can the rear head restraints be removed?	Two Door Models – No Four Door Models – Yes	Two Door – None Four Door – The center head restraint can be removed if it interferes with the installation of the child restraint. For further information, see ⇨ page 48.
Can the buckle stalk be twisted to tighten the seat belt against the belt path of the child restraint?	No	Do not twist the buckle stalk in a seating position with an ALR retractor.

#### NOTE:

If the folding, non-adjustable head restraint interferes with the installation of the child restraint, the head restraint may be folded and the child seat installed in front of it (Two-Door Models).

#### WARNING!

Always make sure the head restraint is in its upright position when the seat is to be used by an occupant who is not in a child restraint. Sitting in a seat with the head restraint in its lowered position could result in serious injury or death in a collision.

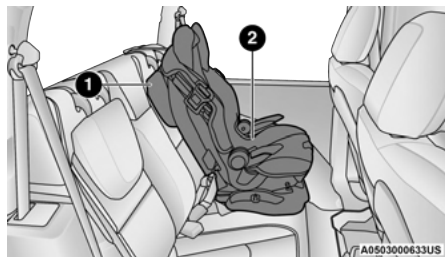

**Car Seat With Head Restraint Folded**

- 1 – Folded Headrest
- 2 – Child Restraint

#### Installing A Child Restraint With A Switchable Automatic Locking Retractor (ALR):

Child restraint systems are designed to be secured in vehicle seats by lap belts or the lap belt portion of a lap/shoulder belt.

#### WARNING!

- Improper installation or failure to properly secure a child restraint can lead to failure of the restraint. The child could be badly injured or killed.

(Continued)

**WARNING!**

- Follow the child restraint manufacturer's directions exactly when installing an infant or child restraint.
1. Place the child seat in the center of the seating position. If the second row seat can be reclined, you may recline the seat and/or raise the head restraint (if adjustable) to get a better fit. If the rear seat can be moved forward and rearward in the vehicle, you may wish to move it to its rear-most position to make room for the child seat. You may also move the front seat forward to allow more room for the child seat.
  2. Pull enough of the seat belt webbing from the retractor to pass it through the belt path of the child restraint. Do not twist the belt webbing in the belt path.
  3. Slide the latch plate into the buckle until you hear a "click."
  4. Pull on the webbing to make the lap portion tight against the child seat.
  5. To lock the seat belt, pull down on the shoulder part of the belt until you have pulled all the seat belt webbing out of the retractor. Then, allow the webbing to retract back into the

retractor. As the webbing retracts, you will hear a clicking sound. This means the seat belt is now in the Automatic Locking mode.

6. Try to pull the webbing out of the retractor. If it is locked, you should not be able to pull out any webbing. If the retractor is not locked, repeat step 5.
7. Finally, pull up on any excess webbing to tighten the lap portion around the child restraint while you push the child restraint rearward and downward into the vehicle seat.
8. If the child restraint has a top tether strap and the seating position has a top tether anchorage, connect the tether strap to the anchorage and tighten the tether strap. See ⇨ page 325 for directions to attach a tether anchor.
9. Test that the child restraint is installed tightly by pulling back and forth on the child seat at the belt path. It should not move more than 1 inch (25.4 mm) in any direction.

Any seat belt system will loosen with time, so check the belt occasionally, and pull it tight if necessary.

**Installing Child Restraints Using The Top Tether Anchorage****WARNING!**

Do not attach a tether strap for a rear-facing car seat to any location in front of the car seat, including the seat frame or a tether anchorage. Only attach the tether strap of a rear-facing car seat to the tether anchorage that is approved for that seating position, located behind the top of the vehicle seat. For the location of approved tether anchorages in your vehicle, see ⇨ page 318.



1. Look behind the seating position where you plan to install the child restraint to find the tether anchorage. If the seat can be moved, you may need to move the seat forward to provide better access to the tether anchorage. If there is no top tether anchorage for that seating position, move the child restraint to another position in the vehicle if one is available.
2. Route the tether strap to provide the most direct path for the strap between the anchor and the child seat. If your vehicle is equipped with adjustable rear head restraints, raise the head restraint, and where possible, route the tether strap under the head restraint and between the two posts. If not possible, lower the head restraint and pass the tether strap around the outboard side of the head restraint.

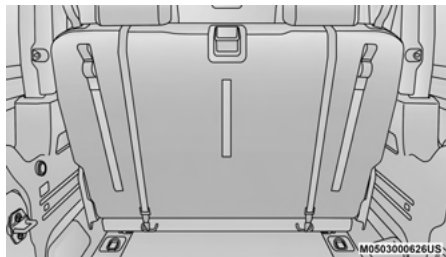

**Tether Strap Mounting (Two-Door Models)**

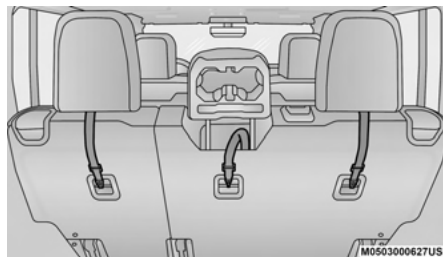

**Tether Strap Mounting  
(Four-Door Models With Center Armrest)**

3. Attach the tether strap hook of the child restraint to the top tether anchorage as shown in the diagram.
4. Remove slack in the tether strap according to the child restraint manufacturer's instructions.

#### **WARNING!**

- An incorrectly anchored tether strap could lead to increased head motion and possible injury to the child. Use only the anchorage position directly behind the child seat to secure a child restraint top tether strap.
- If your vehicle is equipped with a split rear seat, make sure the tether strap does not slip into the opening between the seatbacks as you remove slack in the strap.

#### **Center Tether Attachment – Four-Door Without Center Armrest**

1. If adjustable, lower the adjustable center head restraint to the full down position.
2. Route the tether strap over the seatback and head restraint.

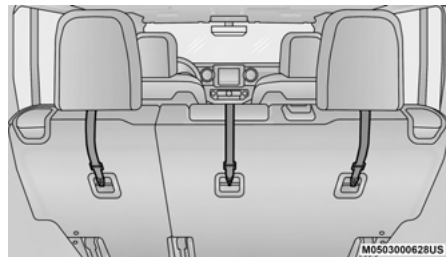

**Tether Strap Mounting  
(Four-Door Models Without Center Armrest)**

3. Attach the tether strap hook of the child restraint to the center tether anchorage located on the back of the seat.
4. Remove slack in the tether strap according to the child restraint manufacturer's instructions.



## SAFETY TIPS

### TRANSPORTING PASSENGERS

NEVER TRANSPORT PASSENGERS IN THE CARGO AREA.

#### WARNING!

- Do not leave children or animals inside parked vehicles in hot weather. Interior heat buildup may cause serious injury or death.
- It is extremely dangerous to ride in a cargo area, inside or outside of a vehicle. In a collision, people riding in these areas are more likely to be seriously injured or killed.
- Do not allow people to ride in any area of your vehicle that is not equipped with seats and seat belts.
- Be sure everyone in your vehicle is in a seat and using a seat belt properly.

### TRANSPORTING PETS

Air Bags deploying in the front seat could harm your pet. An unrestrained pet will be thrown about and possibly injured, or injure a passenger during panic braking or in a collision.

Pets should be restrained in the rear seat (if equipped) in pet harnesses or pet carriers that are secured by seat belts.

### CONNECTED VEHICLES

Privacy of any wireless and wired communications cannot be assured. Third parties may unlawfully intercept information and private communications without your consent. For further information, refer to “Data Collection & Privacy” in your Uconnect Owner’s Manual Supplement or “Onboard Diagnostic System (OBD II) Cybersecurity” ↪ page 137.

#### WARNING!

It is not possible to know or to predict all of the possible outcomes if your vehicle’s systems are breached. It may be possible that vehicle systems, including safety related systems, could be impaired or a loss of vehicle control could occur that may result in an accident involving serious injury or death.

### SAFETY CHECKS YOU SHOULD MAKE INSIDE THE VEHICLE

#### Seat Belts

Inspect the seat belt system periodically, checking for cuts, frays, and loose parts. Damaged parts

must be replaced immediately. Do not disassemble or modify the system.

If your vehicle is involved in a collision, or if you have questions regarding seat belt or retractor conditions, take your vehicle to an authorized FCA dealer or authorized FCA Certified Collision Care Program facility for inspection.

#### Air Bag Warning Light



The Air Bag Warning Light will turn on for four to eight seconds as a bulb check when the ignition switch is first placed in the ON/RUN position. If the light is either not on during starting, stays on, or turns on while driving, have the system inspected at an authorized dealer as soon as possible. This light will illuminate with a single chime when a fault with the Air Bag Warning Light has been detected, it will stay on until the fault is removed. If the light comes on intermittently or remains on while driving, have an authorized dealer service the vehicle immediately. See ↪ page 295 for further information.

#### Defroster

Check operation by selecting the defrost mode and place the blower control on high speed. You should be able to feel the air directed against the windshield. See an authorized dealer for service if your defroster is inoperable.

## Floor Mat Safety Information

Always use floor mats designed to fit your vehicle. Only use a floor mat that does not interfere with the operation of the pedal assemblies. Only use a floor mat that is securely attached using the floor mat fasteners so it cannot slip out of position and interfere with the pedal assemblies or impair safe operation of your vehicle in other ways.

### WARNING!

An improperly attached, damaged, folded, or stacked floor mat, or damaged floor mat fasteners may cause your floor mat to interfere with the accelerator, brake, or clutch pedals and cause a loss of vehicle control. To prevent **SERIOUS INJURY or DEATH:**



- ALWAYS securely attach your floor mat using the floor mat fasteners. DO NOT install your floor mat upside down or turn your floor mat over. Lightly pull to confirm mat is secured using the floor mat fasteners on a regular basis.



- ALWAYS REMOVE THE EXISTING FLOOR MAT FROM THE VEHICLE before installing any other floor mat. NEVER install or stack an additional floor mat on top of an existing floor mat.

(Continued)

### WARNING!

- ONLY install floor mats designed to fit your vehicle. NEVER install a floor mat that cannot be properly attached and secured to your vehicle. If a floor mat needs to be replaced, only use a FCA approved floor mat for the specific make, model, and year of your vehicle.
- ONLY use the driver's side floor mat on the driver's side floor area. To check for interference, with the vehicle properly parked with the engine off, fully depress the accelerator, the brake, and the clutch pedal (if present) to check for interference. If your floor mat interferes with the operation of any pedal, or is not secure to the floor, remove the floor mat from the vehicle and place the floor mat in your trunk.
- ONLY use the passenger's side floor mat on the passenger's side floor area.
- ALWAYS make sure objects cannot fall or slide into the driver's side floor area when the vehicle is moving. Objects can become trapped under accelerator, brake, or clutch pedals and could cause a loss of vehicle control.

(Continued)

### WARNING!

- NEVER place any objects under the floor mat (e.g., towels, keys, etc.). These objects could change the position of the floor mat and may cause interference with the accelerator, brake, or clutch pedals.
- If the vehicle carpet has been removed and re-installed, always properly attach carpet to the floor and check the floor mat fasteners are secure to the vehicle carpet. Fully depress each pedal to check for interference with the accelerator, brake, or clutch pedals then re-install the floor mats.
- It is recommended to only use mild soap and water to clean your floor mats. After cleaning, always check your floor mat has been properly installed and is secured to your vehicle using the floor mat fasteners by lightly pulling mat.

## PERIODIC SAFETY CHECKS YOU SHOULD MAKE OUTSIDE THE VEHICLE

### Tires

Examine tires for excessive tread wear and uneven wear patterns. Check for stones, nails, glass, or other objects lodged in the tread or sidewall. Inspect the tread for cuts and cracks. Inspect sidewalls for cuts, cracks, and bulges. Check the lug nut/bolt torque for tightness. Check the tires (including spare) for proper cold inflation pressure.

### Lights

Have someone observe the operation of brake lights and exterior lights while you work the controls. Check turn signal and high beam indicator lights on the instrument panel.

### Door Latches

Check for proper closing, latching, and locking.

### Fluid Leaks

Check area under vehicle after overnight parking for fuel, coolant, oil, or other fluid leaks. Also, if gasoline fumes are detected or if fuel or brake fluid leaks are suspected, the cause should be located and corrected immediately.

## EXHAUST GAS

### WARNING!

Exhaust gases can injure or kill. They contain carbon monoxide (CO), which is colorless and odorless. Breathing it can make you unconscious and can eventually poison you. To avoid breathing (CO), follow these safety tips:

- Do not run the engine in a closed garage or in confined areas any longer than needed to move your vehicle in or out of the area.
- If you are required to drive with the trunk/lift-gate/rear doors open, make sure that all windows are closed and the climate control BLOWER switch is set at high speed. DO NOT use the recirculation mode.
- If it is necessary to sit in a parked vehicle with the engine running, adjust your heating or cooling controls to force outside air into the vehicle. Set the blower at high speed.

The best protection against carbon monoxide entry into the vehicle body is a properly maintained engine exhaust system.

Whenever a change is noticed in the sound of the exhaust system, when exhaust fumes can be detected inside the vehicle, or when the underside or rear of the vehicle is damaged, have an

authorized dealer inspect the complete exhaust system and adjacent body areas for broken, damaged, deteriorated, or mispositioned parts. Open seams or loose connections could permit exhaust fumes to seep into the passenger compartment. In addition, inspect the exhaust system each time the vehicle is raised for lubrication or oil change. Replace as required.

## CARBON MONOXIDE WARNINGS

### WARNING!

Carbon monoxide (CO) in exhaust gases is deadly. Follow the precautions below to prevent carbon monoxide poisoning:

- Do not inhale exhaust gases. They contain carbon monoxide, a colorless and odorless gas, which can kill. Never run the engine in a closed area, such as a garage, and never sit in a parked vehicle with the engine running for an extended period. If the vehicle is stopped in an open area with the engine running for more than a short period, adjust the ventilation system to force fresh, outside air into the vehicle.
- Guard against carbon monoxide with proper maintenance. Have the exhaust system inspected every time the vehicle is raised. Have any abnormal conditions repaired promptly. Until repaired, drive with all side windows fully open.

## IN CASE OF EMERGENCY

### HAZARD WARNING FLASHERS

The Hazard Warning Flashers button is located on the instrument panel below the climate controls.

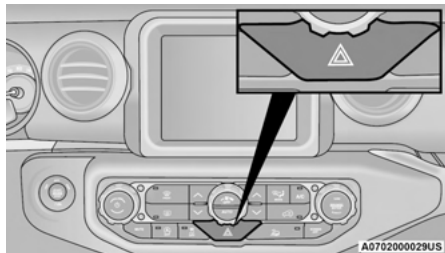

**Hazard Warning Flashers Button**

Push the button to turn on the Hazard Warning Flashers. When the button is activated, all directional turn signals will flash on and off to warn oncoming traffic of an emergency. Push the button a second time to turn off the Hazard Warning Flashers.

This is an emergency warning system and it should not be used when the vehicle is in motion. Use it only when your vehicle is disabled or signaling a safety hazard warning for other motorists.

When you must leave the vehicle to seek assistance, the Hazard Warning Flashers will continue to operate even though the ignition is placed in the OFF position.

**NOTE:**

With extended use the Hazard Warning Flashers may wear down your battery.

### ASSIST AND SOS SYSTEM — IF EQUIPPED

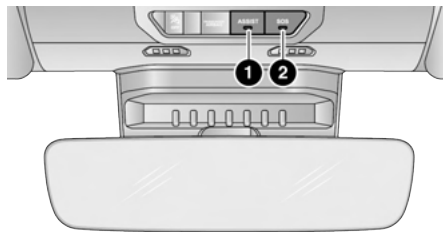

**Assist And SOS Buttons**

- 1 — Assist Button
- 2 — SOS Button

If equipped, the overhead console contains an Assist and an SOS button.

### WARNING!

ALWAYS obey traffic laws and pay attention to the road. ALWAYS drive safely with your hands on the steering wheel. You have full responsibility and assume all risks related to the use of the features and applications in this vehicle. Only use the features and applications when it is safe to do so. Failure to do so may result in an accident involving serious injury or death.

**NOTE:**

- Your vehicle may be transmitting data as authorized by the subscriber ↪ page 431.
- The ASSIST and SOS buttons will only function if you are connected to an operable LTE (voice/data) or 4G (data) network, which comes as a built-in function. Other Uconnect services will only be operable if your SiriusXM Guardian™ service is active and you are connected to an operable LTE (voice/data) or 4G (data) network.

### Assist Call

The Assist Button is used to automatically connect you to any one of the following support centers:

- Roadside Assistance – If you get a flat tire, or need a tow, just push the ASSIST button and

you'll be connected to someone who can help. Roadside Assistance will know what vehicle you're driving and its location. Additional fees may apply for roadside assistance.

- SiriusXM Guardian™ Customer Care – In-vehicle support for SiriusXM Guardian™.
- Vehicle Customer Care – Total support for all other vehicle issues.
- Uconnect Customer Care - Total support for Radio, Phone and NAV issues.

### SOS Call

1. Push the SOS Call button on the overhead console.

#### NOTE:

In case the SOS Call button is pushed in error, there will be a 10 second delay before the SOS Call system initiates a call to an SOS operator. To cancel the SOS Call connection, push the SOS call button on the overhead console or press the cancellation button on the Device Screen. Termination of the SOS Call will turn off the green LED light on the overhead console.

2. The LED light located within the ASSIST and SOS buttons on the overhead console will turn green once a connection to an SOS operator has been made.
3. Once a connection between the vehicle and an SOS operator is made, the SOS Call system

may transmit the following important vehicle information to an SOS operator:

- Indication that the occupant placed an SOS Call
  - The vehicle brand
  - The last known GPS coordinates of the vehicle
4. You should be able to speak with the SOS operator through the vehicle audio system to determine if additional help is needed.

#### WARNING!

ALWAYS obey traffic laws and pay attention to the road. ALWAYS drive safely with your hands on the steering wheel. You have full responsibility and assume all risks related to the use of the features and applications in this vehicle. Only use the features and applications when it is safe to do so. Failure to do so may result in an accident involving serious injury or death.

#### NOTE:

- Your vehicle may be transmitting data as authorized by the subscriber.
- Once a connection is made between the vehicle's SOS Call system and the SOS operator, the SOS operator may be able to open a voice connection with the vehicle to deter-

mine if additional help is needed. Once the SOS operator opens a voice connection with the vehicle's SOS Call system, the operator should be able to speak with you or other vehicle occupants and hear sounds occurring in the vehicle. The vehicle's SOS Call system will attempt to remain connected with the SOS operator until the SOS operator terminates the connection.

5. The SOS operator may attempt to contact appropriate emergency responders and provide them with important vehicle information and GPS coordinates.

#### WARNING!

- If anyone in the vehicle could be in danger (e.g., fire or smoke is visible, dangerous road conditions or location), do not wait for voice contact from an Emergency Services Agent. All occupants should exit the vehicle immediately and move to a safe location.
- Never place anything on or near the vehicle's operable network and GPS antennas. You could prevent operable network and GPS signal reception, which can prevent your vehicle from placing an emergency call. An operable network and GPS signal reception is required for the SOS Call system to function properly.

(Continued)

**WARNING!**

- The SOS Call system is embedded into the vehicle's electrical system. Do not add aftermarket electrical equipment to the vehicle's electrical system. This may prevent your vehicle from sending a signal to initiate an emergency call. To avoid interference that can cause the SOS Call system to fail, never add aftermarket equipment (e.g., two-way mobile radio, CB radio, data recorder, etc.) to your vehicle's electrical system or modify the antennas on your vehicle. **IF YOUR VEHICLE LOSES BATTERY POWER FOR ANY REASON (INCLUDING DURING OR AFTER AN ACCIDENT), THE UCONNECT FEATURES, APPS AND SERVICES, AMONG OTHERS, WILL NOT OPERATE.**
- Modifications to any part of the SOS Call system could cause the air bag system to fail when you need it. You could be injured if the air bag system is not there to help protect you.

**SOS Call System Limitations**

Vehicles sold in Mexico **DO NOT** have SOS Call system capabilities.

SOS or other emergency line operators in Mexico may not answer or respond to SOS system calls.

If the SOS Call system detects a malfunction, any of the following may occur at the time the malfunction is detected, and at the beginning of each ignition cycle:

- The light located within the Assist and SOS buttons will continuously illuminate red.
- The Device Screen will display the following message "Vehicle device requires service. Please contact an authorized dealer."
- An In-Vehicle Audio message will state "Vehicle device requires service. Please contact an authorized dealer."

**WARNING!**

- Ignoring the Rearview Mirror light could mean you will not have SOS Call services. If the Rearview Mirror light is illuminated, have an authorized dealer service the SOS Call system immediately.
- The Occupant Restraint Control module turns on the air bag Warning Light on the instrument panel if a malfunction in any part of the system is detected. If the Air Bag Warning Light is illuminated, have an authorized dealer service the Occupant Restraint Control system immediately.

Even if the SOS Call system is fully functional, factors beyond FCA US LLC's control may prevent or stop the SOS Call system operation. These include, but are not limited to, the following factors:

- The ignition is in the OFF position
- The vehicle's electrical systems are not intact
- The SOS Call system software and/or hardware are damaged during a crash
- The vehicle battery loses power or becomes disconnected during a vehicle crash
- LTE (voice/data) or 4G (data) network and/or Global Positioning Satellite signals are unavailable or obstructed
- Equipment malfunction at the SOS operator facility
- Operator error by the SOS operator
- LTE (voice/data) or 4G (data) network congestion
- Weather
- Buildings, structures, geographic terrain, or tunnels

**WARNING!**

ALWAYS obey traffic laws and pay attention to the road. ALWAYS drive safely with your hands on the steering wheel. You have full responsibility and assume all risks related to the use of the features and applications in this vehicle. Only use the features and applications when it is safe to do so. Failure to do so may result in an accident involving serious injury or death.

**CAUTION!**

To avoid damage to the mirror during cleaning, never spray any cleaning solution directly onto the mirror. Apply the solution onto a clean cloth and wipe the mirror clean.

**NOTE:**

- Your vehicle may be transmitting data as authorized by the subscriber.
- Never place anything on or near the vehicle's LTE (voice/data) or 4G (data) and GPS antennas. You could prevent LTE (voice/data) or 4G (data) and GPS signal reception, which can prevent your vehicle from placing an emergency call. An operable LTE (voice/data) or 4G (data) network connection and a GPS signal is required for the SOS Call system to function properly.

**NOTE:**

Changes or modifications not expressly approved by the party responsible for compliance could void the user's authority to operate the equipment.

**Automatic SOS — If Equipped**

Automatic SOS is a hands-free safety service that can immediately connect you with help in the event that your vehicle's airbags deploy. Please refer to your provided radio supplement for complete information.

**JACKING AND TIRE CHANGING****WARNING!**

- Do not attempt to change a tire on the side of the vehicle close to moving traffic. Pull far enough off the road to avoid the danger of being hit when operating the jack or changing the wheel.
- Being under a jacked-up vehicle is dangerous. The vehicle could slip off the jack and fall on you. You could be crushed. Never put any part of your body under a vehicle that is on a jack. If you need to get under a raised vehicle, take it to a service center where it can be raised on a lift.

*(Continued)*

**WARNING!**

- Never start or run the engine while the vehicle is on a jack.
- The jack is designed to be used as a tool for changing tires only. The jack should not be used to lift the vehicle for service purposes. The vehicle should be jacked on a firm level surface only. Avoid ice or slippery areas.

**PREPARATIONS FOR JACKING**

1. Park on a firm, level surface. Avoid ice or slippery areas.

**WARNING!**

Do not attempt to change a tire on the side of the vehicle close to moving traffic. Pull far enough off the road to avoid being hit when operating the jack or changing the wheel.

2. Turn on the Hazard Warning Flashers.
3. Apply the parking brake.
4. Shift the automatic transmission into PARK (P), or a manual transmission into REVERSE (R).

- Turn the ignition OFF.
- Block both the front and rear of the wheel diagonally opposite of the jacking position. For example, if the driver's front wheel is being changed, block the passenger's rear wheel.

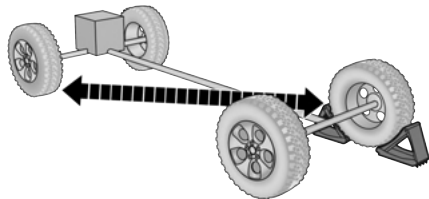

A0707001133US

**Wheel Blocked Example****NOTE:**

Passengers should not remain in the vehicle when the vehicle is being lifted or raised.

**JACK LOCATION**

The jack and lug wrench are located in the rear cargo area. To remove jack and tools proceed as follows:

- Lift the load floor in the cargo area.

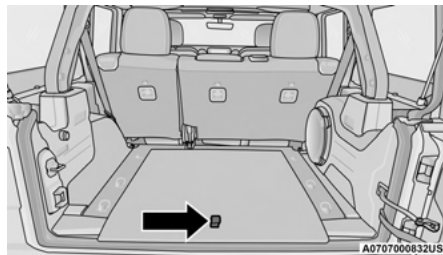

A0707000832US

**Load Floor Handle****NOTE:**

The load floor can be removed for easier access by pulling the load floor handle up and directly rearward.

- Remove the hardware storage cover by pinching the latch on the left side and pulling upward.

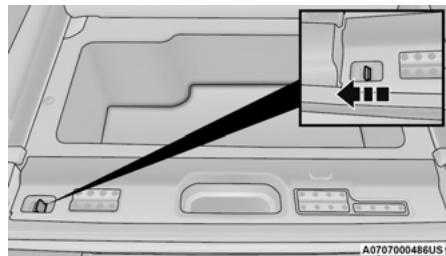

A0707000486US

**Hardware Storage Cover Latch**

- Turn the plastic wing nut counterclockwise to loosen the jack from the storage bin.

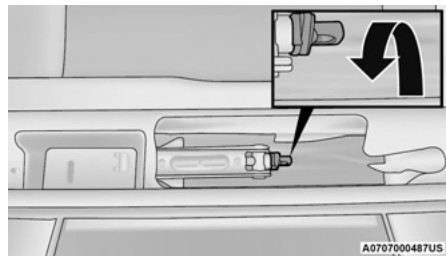

A0707000487US

**Plastic Wing Nut Location**

- Remove tool kit and assemble tools.



## SPARE TIRE REMOVAL

1. To remove the spare tire from the carrier, remove the tire cover, if equipped.
2. Remove the Rear Camera Cover by turning the lock bolt counterclockwise with the #T40 torx head driver and ratchet from the supplied tool kit.

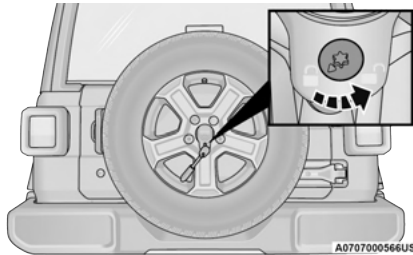

Unlock Rear Camera Cover

3. Remove the lug nuts with the lug wrench turning them counterclockwise. If equipped, remove the locking lug nut with the lock key (located in the glove box) turning it counterclockwise.

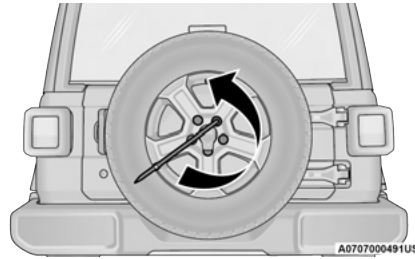

Removing The Spare Tire

## JACKING INSTRUCTIONS

### WARNING!

Carefully follow these tire changing warnings to help prevent personal injury or damage to your vehicle:

- Always park on a firm, level surface as far from the edge of the roadway as possible before raising the vehicle.
- Turn on the Hazard Warning Flashers.
- Apply the parking brake firmly and shift an automatic transmission in PARK; a manual transmission to REVERSE.

(Continued)

### WARNING!

- Block the wheel diagonally opposite the wheel to be raised.
- Never start or run the engine with the vehicle on a jack.
- Do not let anyone sit in the vehicle when it is on a jack.
- Do not get under the vehicle when it is on a jack. If you need to get under a raised vehicle, take it to a service center where it can be raised on a lift.
- Only use the jack in the positions indicated and for lifting this vehicle during a tire change.
- If working on or near a roadway, be extremely careful of motor traffic.
- To assure that spare tires, flat or inflated, are securely stowed, spares must be stowed with the valve stem facing the ground.



060600714

### Jack Warning Label

1. Remove the spare tire, jack and tools from the stored location.
2. Loosen (but do not remove) the wheel lug nuts by turning them to the left one turn while the wheel is still on the ground.
3. Assemble the jack and jacking tools. Connect the jack handle driver to the extension, then to the lug wrench.

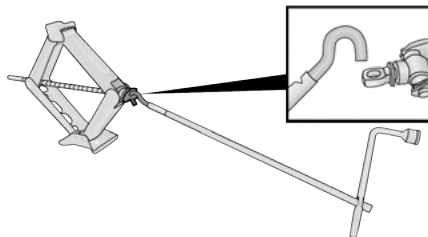

A0707000493US

### Assembled Jack And Tools

#### NOTE:

If your vehicle comes with factory equipped 35 inch (88.9 centimeters) tires, a jack lift block is provided in the rear cargo area. The jack lift block is used to provide higher ground clearance when changing a flat or spare tire. When placing the jack lift block under the jack, be sure the bottom of the jack fits securely inside of the raised edges of the block.

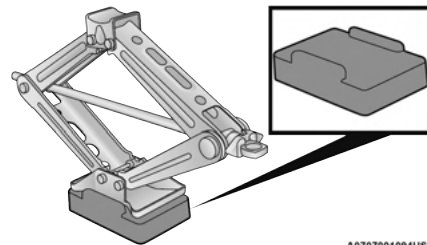

A0707001094US

### Jack Lift Box Usage

4. Operate the jack from the front or the rear of the vehicle. Place the jack under the axle tube, as shown. **Do not raise the vehicle until you are sure the jack is fully engaged.**

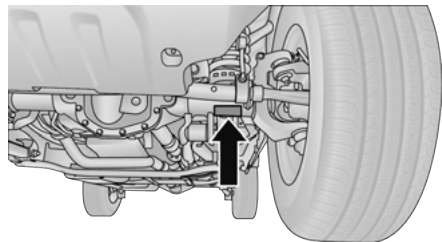

A0707000494US

### Front Lifting Point

**NOTE:**

Keep the jack and tools aligned while raising the vehicle to prevent tool damage.

**CAUTION!**

Do not attempt to raise the vehicle by jacking on locations other than those indicated.

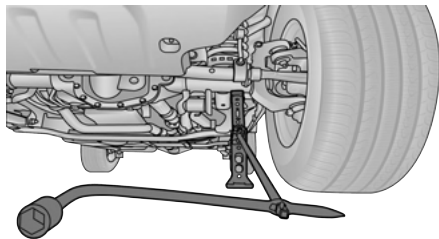

A0707000495US

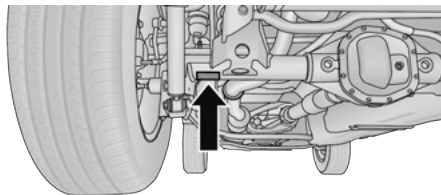
**Front Jacking Location**

A0707000496US

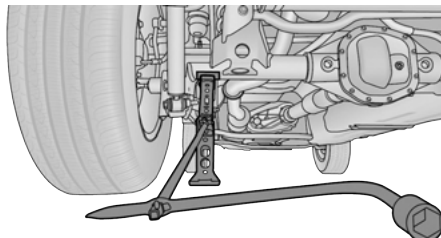
**Rear Lifting Point**

A0707000497US

**Rear Jacking Location**

5. Raise the vehicle by turning the jack screw clockwise. Raise the vehicle only until the tire just clears the surface and enough clearance is obtained to install the spare tire. Minimum tire lift provides maximum stability.

**WARNING!**

Raising the vehicle higher than necessary can make the vehicle less stable. It could slip off the jack and hurt someone near it. Raise the vehicle only enough to remove the tire.

6. Remove the lug nuts and wheel.
7. Mount the spare tire on the axle.
8. Install the lug nuts with the cone-shaped end toward the wheel. Lightly tighten the lug nuts clockwise.

**WARNING!**

To avoid the risk of forcing the vehicle off the jack, do not tighten the wheel nuts fully until the vehicle has been lowered. Failure to follow this warning may result in serious injury.

9. Lower the vehicle by turning the jack screw to the counterclockwise, and remove the jack.
10. Finish tightening the wheel bolts. Push down on the wrench while at the end of the handle for increased leverage. Tighten the wheel bolts in a star pattern until each wheel bolt has been tightened twice → page 417. If in doubt about the correct tightness, have them checked with a torque wrench by an authorized dealer or at a service station.

11. After 25 miles (40 km), check the lug nut torque with a torque wrench to ensure that all lug nuts are properly seated against the wheel.
12. Remove the jack assembly and wheel blocks.
13. Secure the jack and tools in their proper locations.
14. Secure the damaged wheel/tire on the spare tire carrier. Torque down lug nuts and locking lug nut.
15. Return the lock bolt to the lock position on the camera cover by turning the lock clockwise using the provided #40 torx head driver and ratchet. Then, reinstall the camera cover by slipping it over the camera/tire carrier until it snaps into place.

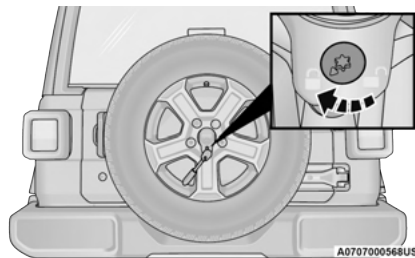

Lock Bolt Location

**WARNING!**

A loose tire or jack thrown forward in a collision or hard stop, could endanger the occupants of the vehicle. Always stow the jack parts and the spare tire in the places provided.

**JUMP STARTING**

If your vehicle has a discharged battery, it can be jump started using a set of jumper cables and a battery in another vehicle, or by using a portable battery booster pack. Jump starting can be dangerous if done improperly, so please follow the procedures in this section carefully.

**WARNING!**

Do not attempt jump starting if the battery is frozen. It could rupture or explode and cause personal injury.

**CAUTION!**

Do not use a portable battery booster pack or any other booster source with a system voltage greater than 12 Volts or damage to the battery, starter motor, alternator or electrical system may occur.

**NOTE:**

When using a portable battery booster pack, follow the manufacturer's operating instructions and precautions.

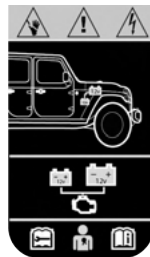
**PREPARATIONS FOR JUMP START**

M0624000004US

Supplemental Battery - If Equipped

**WARNING!**

- Only use the positive battery post on the main battery to jump start your vehicle. Serious injury or death could result if you attempt to jump start using the supplemental battery.
- Battery gas is flammable and explosive. Keep flame or sparks away from the battery. Do not use a booster battery or any other booster source with an output greater than 12 Volts. Do not allow cable clamps to touch each other.

(Continued)

**WARNING!**

- Battery posts, terminals, and related accessories contain lead and lead compounds. Wash hands after handling.
- If a “fast charger” is used while the battery is in the vehicle, disconnect both vehicle battery cables before connecting the charger to the battery. Do not use a “fast charger” to provide starting.

The battery in your vehicle is located in the right rear of the engine compartment.

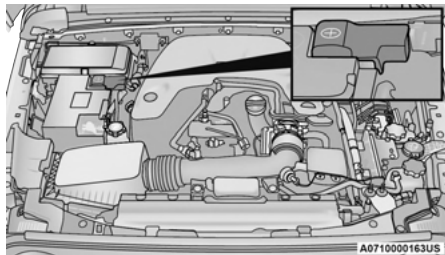

**Positive (+) Battery Post – Gas Engine**

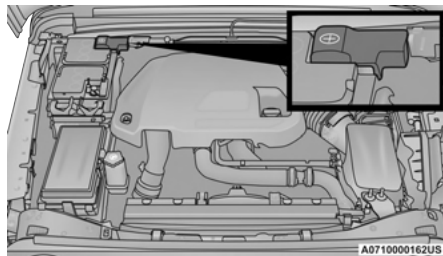

**Positive (+) Battery Post – Diesel Engine**

**NOTE:**

The positive (+) battery post is covered with a protective cap. Lift up on the cap to gain access to the post.

If your vehicle is equipped with a Stop/Start system, it will be equipped with two batteries  
 ☞ page 165.

See the following steps to prepare for jump starting:

1. Apply the parking brake, shift the automatic transmission into PARK (P) (manual transmission in NEUTRAL) and turn the ignition OFF.
2. Turn off the heater, radio, and all electrical accessories.

3. Pull upward and remove the protective cover over the positive (+) battery post.
4. If using another vehicle to jump start the battery, park the vehicle within the jumper cable's reach, apply the parking brake and make sure the ignition is OFF.

**WARNING!**

Do not allow vehicles to touch each other as this could establish a ground connection and personal injury could result.

**WARNING!**

- Take care to avoid the radiator cooling fan whenever the hood is raised. It can start anytime the ignition switch is ON. You can be injured by moving fan blades.
- Remove any metal jewelry such as rings, watch bands and bracelets that could make an inadvertent electrical contact. You could be seriously injured.
- Batteries contain sulfuric acid that can burn your skin or eyes and generate hydrogen gas which is flammable and explosive. Keep open flames or sparks away from the battery.

## JUMP STARTING PROCEDURE

### WARNING!

Failure to follow this jump starting procedure could result in personal injury or property damage due to battery explosion.

### CAUTION!

Failure to follow these procedures could result in damage to the charging system of the booster vehicle or the discharged vehicle.

### NOTE:

Make sure at all times that unused ends of jumper cables are not contacting each other or either vehicle while making connections.

### Connecting The Jumper Cables

1. Connect the positive (+) end of the jumper cable to the positive (+) post of the discharged vehicle.
2. Connect the opposite end of the positive (+) jumper cable to the positive (+) post of the booster battery.
3. Connect the negative (-) end of the jumper cable to the negative (-) post of the booster battery.

4. Connect the opposite end of the negative (-) jumper cable to a good engine ground. A “ground” is an exposed metallic/unpainted part of the engine, frame or chassis, such as an accessory bracket or large bolt. The ground must be away from the battery and the fuel injection system.

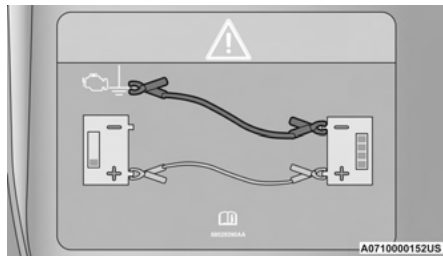

Jump Starting Label

### WARNING!

Do not connect the jumper cable to the negative (-) post of the discharged battery. The resulting electrical spark could cause the battery to explode and could result in personal injury.

5. Start the engine in the vehicle that has the booster battery, let the engine idle a few minutes, and then start the engine in the vehicle with the discharged battery.

### CAUTION!

Do not run the booster vehicle engine above 2,000 RPM since it provides no charging benefit, wastes fuel, and can damage booster vehicle engine.

6. Once the engine is started, remove the jumper cables in the reverse sequence.

### Disconnecting The Jumper Cables

1. Disconnect the negative (-) end of the jumper cable from the engine ground of the vehicle with the discharged battery.
2. Disconnect the opposite end of the negative (-) jumper cable from the negative (-) post of the booster battery.
3. Disconnect the positive (+) end of the jumper cable from the positive (+) post of the booster battery.
4. Disconnect the opposite end of the positive (+) jumper cable from the positive (+) post of the discharged vehicle.

5. Reinstall the protective cover over the positive (+) post of the discharged vehicle.

**NOTE:**

If frequent jump starting is required to start your vehicle you should have the battery and charging system tested at an authorized dealer.

**CAUTION!**

Accessories plugged into the vehicle power outlets draw power from the vehicle's battery, even when not in use (i.e., cellular devices, etc.). Eventually, if plugged in long enough without engine operation, the vehicle's battery will discharge sufficiently to degrade battery life and/or prevent the engine from starting.

**IF YOUR ENGINE OVERHEATS**

If the vehicle is overheating, it will need to be serviced by an authorized dealer.

In any of the following situations, you can reduce the potential for overheating by taking the appropriate action.

- On the highways — slow down.
- In city traffic — while stopped, shift transmission into NEUTRAL, but do not increase engine idle speed.

**CAUTION!**

Driving with a hot cooling system could damage your vehicle. If the temperature gauge reads HOT (H), pull over and stop the vehicle. Idle the vehicle with the air conditioner turned off until the pointer drops back into the normal range. If the pointer remains on HOT (H), and you hear continuous chimes, turn the engine off immediately and call for service.

**NOTE:**

There are steps that you can take to slow down an impending overheat condition:

- If your Air Conditioner (A/C) is on, turn it off. The A/C system adds heat to the engine cooling system and turning the A/C off can help remove this heat.
- You can also turn the temperature control to maximum heat, the mode control to floor and the blower control to high. This allows the heater core to act as a supplement to the radiator and aids in removing heat from the engine cooling system.

**WARNING!**

You or others can be badly burned by hot engine coolant (antifreeze) or steam from your radiator. If you see or hear steam coming from under the hood, do not open the hood until the radiator has had time to cool. Never try to open a cooling system pressure cap when the radiator or coolant bottle is hot.

**MANUAL PARK RELEASE**

In order to move the vehicle in cases where the transmission will not shift out of PARK (P) (such as a depleted battery), a Manual Park Release is available.

**WARNING!**

Always secure your vehicle by fully applying the parking brake before activating the Manual Park Release. In addition, you should be seated in the driver's seat with your foot firmly on the brake pedal when activating the Manual Park Release. Activating the Manual Park Release will allow your vehicle to roll away if it is not secured by the parking brake, or by proper connection to a tow vehicle. Activating the Manual Park Release on an unsecured vehicle could lead to serious injury or death for those in or around the vehicle.

Follow these steps to use the Manual Park Release:

1. Firmly apply the parking brake.
2. Using a small screwdriver or similar tool, remove the manual park release cover located in front of the gear selector, to access the release tether strap.

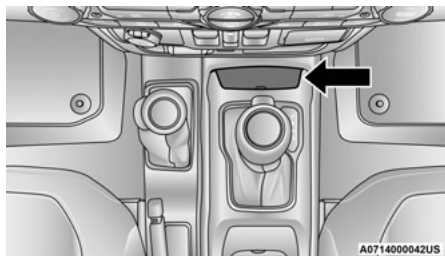

**Manual Park Release Cover**

3. Fish the tether strap up through the opening in the console base.

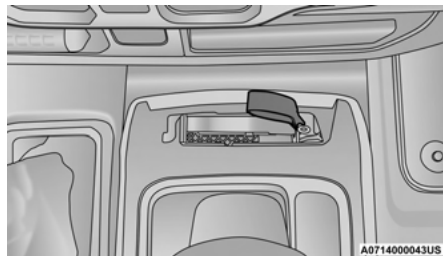

**Tether Strap**

4. Press and maintain firm pressure on the brake pedal.
5. Pull the tether strap up until the release lever locks into place in the vertical position. The vehicle is now out of PARK (P) and can be moved. Release the parking brake only when the vehicle is securely connected to a tow vehicle.

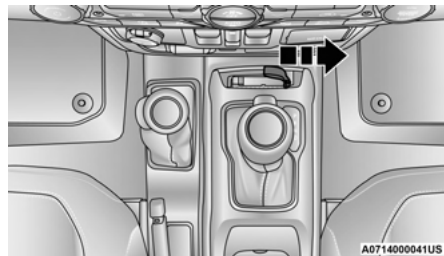

**Released Position**

#### To Reset The Manual Park Release:

1. Pull upward on the tether strap, releasing it from the "locked" position.
2. Lower the Manual Park Release lever downward and to the left, into its original position.

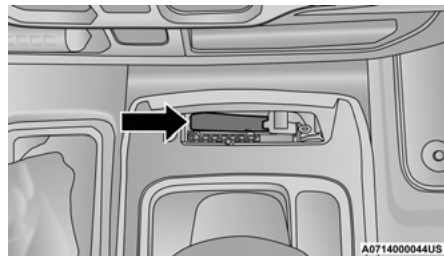

**Reinstalling Tether**



- Tuck the tether strap into the base of the console, and reinstall the cover.

**NOTE:**

When the lever is locked in the release position the access cover cannot be reinstalled.

**FREEING A STUCK VEHICLE**

If your vehicle becomes stuck in mud, sand or snow, it can often be moved using a rocking motion. Turn the steering wheel right and left to clear the area around the front wheels. For vehicles with automatic transmission, push and hold the lock button on the gear selector. Then, shift back and forth between DRIVE (D) and REVERSE (R) (with automatic transmission) or SECOND (2) gear and REVERSE (R) (with manual transmission), while gently pressing the accelerator. Use the least amount of accelerator pedal pressure that will maintain the rocking motion, without spinning the wheels or racing the engine.

**NOTE:**

- For vehicles with automatic transmission: Shifts between DRIVE (D) and REVERSE (R) can only be achieved at wheel speeds of 5 mph (8 km/h) or less. Whenever the transmission remains in NEUTRAL (N) for more than two seconds, you must press the brake pedal to engage DRIVE (D) or REVERSE (R).
- Push the ESC OFF button to place the Electronic Stability Control (ESC) system in “Partial OFF” mode, before rocking the vehicle ↪ page 277. Once the vehicle has been freed, push the ESC OFF button again to restore “ESC On” mode.

**WARNING!**

Fast spinning tires can be dangerous. Forces generated by excessive wheel speeds may cause damage, or even failure, of the axle and tires. A tire could explode and injure someone. Do not spin your vehicle's wheels faster than 30 mph (48 km/h) or for longer than 30 seconds continuously without stopping when you are stuck and do not let anyone near a spinning wheel, no matter what the speed.

**CAUTION!**

- Racing the engine or spinning the wheels may lead to transmission overheating and failure. Allow the engine to idle with the transmission in NEUTRAL for at least one minute after every five rocking-motion cycles. This will minimize overheating and reduce the risk of clutch or transmission failure during prolonged efforts to free a stuck vehicle.
- When “rocking” a stuck vehicle by shifting between DRIVE/SECOND gear and REVERSE, do not spin the wheels faster than 15 mph (24 km/h), or drivetrain damage may result.
- Rewving the engine or spinning the wheels too fast may lead to transmission overheating and failure. It can also damage the tires. Do not spin the wheels above 30 mph (48 km/h) while in gear (no transmission shifting occurring).

## TOWING A DISABLED VEHICLE

This section describes procedures for towing a disabled vehicle using a commercial towing service.

If the transmission and drivetrain are operable, disabled 4x4 vehicles may also be towed as described ⇨ page 198.

Towing Condition	Wheels OFF The Ground	4WD MODELS
Flat Tow	NONE	<ul style="list-style-type: none"> <li>● Automatic Transmission in <b>PARK (P)</b></li> <li>● Manual Transmission in gear (<b>NOT</b> in NEUTRAL)</li> <li>● Transfer Case in <b>NEUTRAL (N)</b></li> <li>● Tow in <b>Forward</b> direction</li> </ul>
Wheel Lift Or Dolly Tow	Front	<b>NOT ALLOWED</b>
	Rear	<b>NOT ALLOWED</b>
Flatbed	<b>ALL</b>	<b>BEST METHOD</b>
<p><b>NOTE:</b> When towing your vehicle, always follow applicable state and provincial laws. Contact state and provincial Highway Safety offices for additional details.</p>		

Proper towing or lifting equipment is required to prevent damage to your vehicle. Use only tow bars and other equipment designed for this purpose, following equipment manufacturer's instructions. Use of safety chains is mandatory. Attach a tow bar or other towing device to main structural members of the vehicle, not to fascia/bumpers or associated brackets. State and local laws regarding vehicles under tow must be observed.

If you must use the accessories (wipers, defrosters, etc.) while being towed, the ignition must be in the ON/RUN position, not the ACC position.

If the vehicle's battery is discharged, instructions on shifting the automatic transmission out of PARK (P) in order to move the vehicle ⇨ page 341.

### CAUTION!

- Do not use sling type equipment when towing. Vehicle damage may occur.
- When securing the vehicle to a flatbed truck, do not attach to front or rear suspension components. Damage to your vehicle may result from improper towing.

## FOUR WHEEL DRIVE MODELS

FCA US LLC recommends towing with all wheels **OFF** the ground. Acceptable methods are to tow the vehicle on a flatbed or with one end of the vehicle raised and the opposite end on a towing dolly.

If flatbed equipment is not available and the transfer case is operable, the vehicle may be towed (in the forward direction, with **ALL** wheels on the ground), **IF** the transfer case is in **NEUTRAL (N)** and the transmission is in **PARK (P)** (for automatic transmissions) or in gear **NOT** in **NEUTRAL**, for manual transmissions) → page 198.

### CAUTION!

- Front or rear wheel lifts must not be used (if the remaining wheels are on the ground). Internal damage to the transmission or transfer case will occur if a front or rear wheel lift is used when towing.
- Towing this vehicle in violation of the above requirements can cause severe transmission and/or transfer case damage. Damage from improper towing is not covered under the New Vehicle Limited Warranty.

## WITHOUT THE KEY FOB

Special care must be taken when the vehicle is towed with the ignition in the OFF mode. The only approved method of towing without the key fob is with a flatbed truck. Proper towing equipment is necessary to prevent damage to the vehicle.

## EMERGENCY TOW HOOKS — IF EQUIPPED

If your vehicle is equipped with tow hooks, they are mounted in the front and the rear fascia/bumpers.

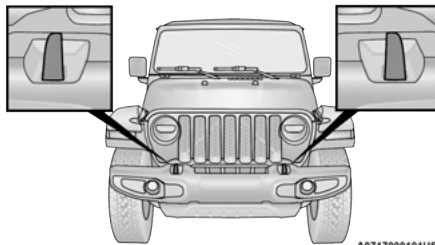

Front Tow Hooks

A0717000101US

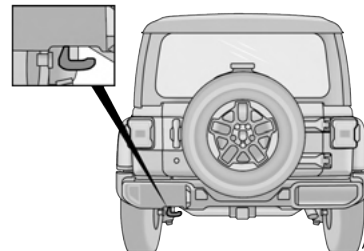

Rear Tow Hook

A0717000102US

### NOTE:

For off-road recovery, it is recommended to use both of the front tow hooks to minimize the risk of damage to the vehicle. Always use an appropriately rated tow strap.

### WARNING!

- Do not use a chain for freeing a stuck vehicle. Chains may break, causing serious injury or death.
- Stand clear of vehicles when pulling with tow hooks. Tow straps may become disengaged, causing serious injury.

**CAUTION!**

Tow hooks are for emergency use only, to rescue a vehicle stranded off road. Do not use tow hooks for tow truck hookup or highway towing. You could damage your vehicle. Tow straps are recommended when towing the vehicle, chains may cause vehicle damage.

**ENHANCED ACCIDENT RESPONSE SYSTEM (EARS)**

This vehicle is equipped with an Enhanced Accident Response System.

This feature is a communication network that takes effect in the event of an impact → page 313.

**EVENT DATA RECORDER (EDR)**

This vehicle is equipped with an event data recorder (EDR). The main purpose of an EDR is to record data that will assist in understanding how a vehicle's systems performed under certain crash or near crash-like situations, such as an air bag deployment or hitting a road obstacle → page 314.

# SERVICING AND MAINTENANCE

## SCHEDULED SERVICING — GASOLINE ENGINE

Your vehicle is equipped with an automatic oil change indicator system. The oil change indicator system will remind you that it is time to take your vehicle in for scheduled maintenance.

Based on engine operation conditions, the oil change indicator message will illuminate. This means that service is required for your vehicle. Operating conditions such as frequent short-trips, trailer tow, extremely hot or cold ambient temperatures will influence when the “Change Oil” or “Oil Change Required” message is displayed. Have your vehicle serviced as soon as possible, within the next 500 miles (805 km).

On vehicles equipped with instrument cluster display, “Oil Change Required” will be displayed and a single chime will sound, indicating that an oil change is necessary.

On non-instrument cluster display equipped vehicles, “Change Oil” will flash in the instrument cluster odometer and a single chime will sound, indicating that an oil change is necessary.

An authorized dealer will reset the oil change indicator message after completing the scheduled oil change. If a scheduled oil change is performed by someone other than an authorized dealer, the message can be reset by referring to the steps described under Instrument Cluster Display for further information ➔ page 120.

### NOTE:

Under no circumstances should oil change intervals exceed 10,000 miles (16,000 km), 12 months or 350 hours of engine run time, whichever comes first. The 350 hours of engine run or idle time is generally only a concern for fleet customers.

### Once A Month Or Before A Long Trip:

- Check the engine oil level.
- Check the windshield washer fluid level.
- Check the tire inflation pressures and look for unusual wear or damage, rotate at the first sign of irregular wear.
- Check the fluid levels of the coolant reservoir, brake master cylinder, and power steering, and fill as needed.
- Check the function of all interior and exterior lights.

## MAINTENANCE PLAN

Refer to the maintenance plan for the required maintenance intervals.

<b>At Every Oil Change Interval As Indicated By Oil Change Indicator System:</b>
● Change oil and filter.
● Rotate the tires. Rotate at the first sign of irregular wear, even if it occurs before the oil indicator system turns on.
● Inspect battery and clean and tighten terminals as required.
● Inspect the CV/Universal joints.
● Inspect brake pads, shoes, rotors, drums, hoses and parking brake.
● Inspect engine cooling system protection and hoses.
● Inspect exhaust system.
● Inspect engine air cleaner filter if using in dusty or off-road conditions; replace engine air cleaner filter if necessary.
● Inspect all door latches for presence of grease; reapply if necessary.

### NOTE:

Using white lithium grease, lubricate the door hinge joints twice a year to prevent premature wear.

Mileage Or Time Passed (Whichever Comes First):	20,000	30,000	40,000	50,000	60,000	70,000	80,000	90,000	100,000	110,000	120,000	130,000	140,000	150,000
Or Years:	2	3	4	5	6	7	8	9	10	11	12	13	14	15
Or Kilometers:	32,000	48,000	64,000	80,000	96,000	112,000	128,000	144,000	160,000	176,000	192,000	208,000	224,000	240,000
<b>Additional Inspections</b>														
Inspect the CV/Universal joints.	X	X	X	X	X	X	X	X	X	X	X	X	X	X
Inspect front suspension, tie rod ends, rear suspension, and replace if necessary.	X		X		X		X		X		X		X	
Inspect the front and rear axle fluid.	X				X				X				X	
Inspect the brake linings, replace as necessary.	X		X		X		X		X		X		X	
Adjust parking brake on vehicles equipped with four wheel disc brakes.	X		X		X		X		X		X		X	
Inspect transfer case fluid.		X						X						X
<b>Additional Maintenance</b>														
Replace engine air cleaner filter.		X			X			X			X			X
Replace cabin air filter.	To be replaced every 12,000 miles (19,000 km).													
Replace Spark Plugs – 2.0L Engine. <sup>1</sup>					X						X			
Replace spark plugs – 3.6L Engine. <sup>1</sup>									X					
Flush and replace the engine, intercooler (if equipped) coolant at 10 years or 150,000 miles (240,000 km) whichever comes first.									X					X

Mileage Or Time Passed (Whichever Comes First):	20,000	30,000	40,000	50,000	60,000	70,000	80,000	90,000	100,000	110,000	120,000	130,000	140,000	150,000
Or Years:	2	3	4	5	6	7	8	9	10	11	12	13	14	15
Or Kilometers:	32,000	48,000	64,000	80,000	96,000	112,000	128,000	144,000	160,000	176,000	192,000	208,000	224,000	240,000
Change the manual transmission fluid if using your vehicle for any of the following: trailer towing, snow plowing, heavy loading, taxi, police, delivery service (commercial service), off-road, desert operation or more than 50% of your driving is at sustained high speeds during hot weather, above 90°F (32°C).		X			X			X			X			X
Change transfer case fluid if using your vehicle for any of the following: police, taxi, fleet, or frequent trailer towing.					X						X			
Inspect and replace PCV valve if necessary.									X					
Change front and rear axle fluid if using your vehicle for police, taxi, fleet, off-road or frequent trailer towing.			X				X				X			

1. The spark plug change interval is mileage based only; yearly intervals do not apply.

### WARNING!

- You can be badly injured working on or around a motor vehicle. Do only service work for which you have the knowledge and the right equipment. If you have any doubt about your ability to perform a service job, take your vehicle to a competent mechanic.
- Failure to properly inspect and maintain your vehicle could result in a component malfunction and affect vehicle handling and performance. This could cause an accident.



## SCHEDULED SERVICING — DIESEL ENGINE

Your vehicle is equipped with an automatic oil change indicator system. The oil change indicator system will remind you that it is time to take your vehicle in for scheduled maintenance.

Based on engine operation conditions, the oil change indicator message will illuminate. This means that service is required for your vehicle. Operating conditions such as frequent short-trips, trailer tow, extremely hot or cold ambient temperatures will influence when the “Oil Change Required” message is displayed. Have your vehicle serviced as soon as possible, within the next 500 miles (805 km).

An authorized dealer will reset the oil change indicator message after completing the scheduled oil change. If a scheduled oil change is performed by someone other than an authorized dealer, to reset the message ⇨ page 120.

### NOTE:

Under no circumstances should oil change intervals exceed 10,000 miles (16,000 km) or 12 months, whichever comes first.

### Engine Oil Filter Replacement

Residual oil in the housing may spill from the housing when the new filter is installed if the residual oil is not either removed from the housing or enough time has not elapsed to allow the oil to drain back into the engine. When servicing the oil filter on this engine, open the filter cap approximately six turns until the cap o-ring is visible and stop. Wait five minutes with the cap in this position to allow dirty engine oil to drain back into the engine. After five minutes, the cap and filter assembly can be removed and discarded. When installing the new oil filter cartridge assembly, ensure the cap is tightened to the specified torque to prevent low oil pressure conditions.

### Once A Month Or Before A Long Trip:

- Check engine oil level
- Check windshield washer fluid level
- Check the tire pressures and look for unusual wear or damage
- Check the fluid levels of the coolant reservoir, brake master cylinder, and fill as needed
- Check function of all interior and exterior lights

**MAINTENANCE PLAN — DIESEL FUEL UP TO B5 BIODIESEL**

Refer to the maintenance plan for the required maintenance intervals.

**At Every Oil Change Interval As Indicated By Oil Change Indicator System:**

- Change oil and filter.
- Completely fill the Diesel Exhaust Fluid tank.
- Drain water from fuel filter assembly.
- Rotate the tires. Rotate at the first sign of irregular wear, even if it occurs before the oil indicator system turns on.
- Inspect battery and clean and tighten terminals as required.
- Inspect the CV/Universal joints.
- Inspect brake pads, shoes, rotors, drums, hoses and parking brake.
- Inspect engine cooling system protection and hoses.
- Inspect exhaust system.
- Inspect engine air cleaner filter if using in dusty or off-road conditions; replace engine air cleaner filter if necessary.

**At Every Second Oil Change Interval As Indicated By Oil Change Indicator System:**

- Change fuel filter.

Mileage Or Time Passed (Whichever Comes First)	10,000	20,000	30,000	40,000	50,000	60,000	70,000	80,000	90,000	100,000	110,000	120,000	130,000	140,000	150,000
Or Years:	1	2	3	4	5	6	7	8	9	10	11	12	13	14	15
Or Kilometers:	16,000	32,000	48,000	64,000	80,000	96,000	112,000	128,000	144,000	160,000	176,000	192,000	208,000	224,000	240,000
<b>Additional Inspections</b>															
Completely fill the Diesel Exhaust Fluid tank.	X	X	X	X	X	X	X	X	X	X	X	X	X	X	X
Inspect the CV/Universal joints.	X	X	X	X	X	X	X	X	X	X	X	X	X	X	X
Inspect front suspension, tie rod ends, and replace if necessary.		X		X		X		X		X		X		X	
Inspect the front and rear axle fluid, change if using your vehicle for police, taxi, fleet, off-road or frequent trailer towing.		X		X		X		X		X		X		X	
Inspect the brake linings, parking brake function.		X		X		X		X		X		X		X	
Inspect transfer case fluid.			X			X			X						X
<b>Additional Maintenance</b>															
Drain water from fuel filter assembly.	X	X	X	X	X	X	X	X	X	X	X	X	X	X	X
Replace fuel filters and drain water from the fuel filter assembly.	Under normal conditions the diesel fuel filter should be replaced every other oil change and must not exceed 20,000 miles (32,000 km) if using diesel fuel up to B5. If the vehicle is being used in severe operating conditions, or in certain geographical areas of the country (Pennsylvania, New York, Ohio, Maryland, West Virginia, Arkansas, Oklahoma, Kansas, Iowa, Missouri and Nebraska) due to fuel cleanliness issues, it is recommended to replace the fuel filter every oil change and must not exceed 10,000 miles.														
Replace engine air cleaner filter.			X			X			X			X			X
Replace the cabin air filter.	To be replaced every 12,000 miles (19,000 km).														

Mileage Or Time Passed (Whichever Comes First)	10,000	20,000	30,000	40,000	50,000	60,000	70,000	80,000	90,000	100,000	110,000	120,000	130,000	140,000	150,000
Or Years:	1	2	3	4	5	6	7	8	9	10	11	12	13	14	15
Or Kilometers:	16,000	32,000	48,000	64,000	80,000	96,000	112,000	128,000	144,000	160,000	176,000	192,000	208,000	224,000	240,000
Flush and replace the engine coolant at 10 years or 150,000 miles (240,000 km) whichever comes first.										X					X
Replace accessory drive belt(s).										X					
Change transfer case fluid.												X			

**WARNING!**

- You can be badly injured working on or around a motor vehicle. Do only service work for which you have the knowledge and the right equipment. If you have any doubt about your ability to perform a service job, take your vehicle to a competent mechanic.
- Failure to properly inspect and maintain your vehicle could result in a component malfunction and affect vehicle handling and performance. This could cause an accident.

**ADDITIONAL MAINTENANCE — B6 TO B20 BIODIESEL****NOTE:**

- Under no circumstances should oil change intervals exceed 8,000 miles (12,875 km) or six months, whichever comes first when using biodiesel blends greater than 5% (B5).
- The owner is required to monitor mileage for B6-B20 biodiesel, the automatic oil change indicator system does not reflect the use of biofuels.
- Fuel filter change interval is maintained at every second oil change. This is especially important with biodiesel usage.

For more information on using biodiesel ⇨ page 421.

## ENGINE COMPARTMENT

### 2.0L GASOLINE ENGINE

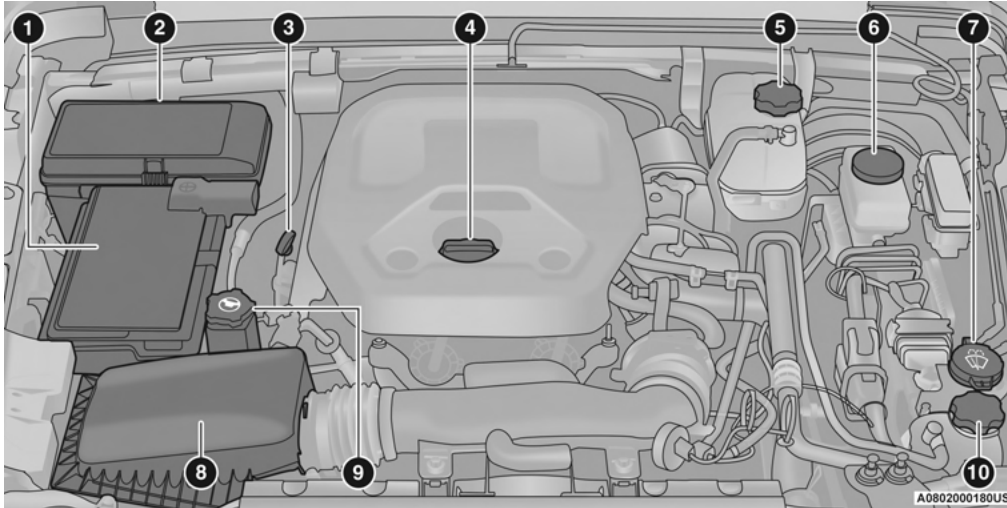

- 1 – Battery
- 2 – Power Distribution Center (Fuses)
- 3 – Engine Oil Dipstick
- 4 – Engine Oil Fill
- 5 – Engine Coolant Pressure Cap

- 6 – Brake Fluid Reservoir Cap
- 7 – Washer Fluid Reservoir Cap
- 8 – Engine Air Cleaner Filter
- 9 – Power Steering Reservoir Cap
- 10 – Intercooler Coolant Reservoir Cap

### 3.6L GASOLINE ENGINE

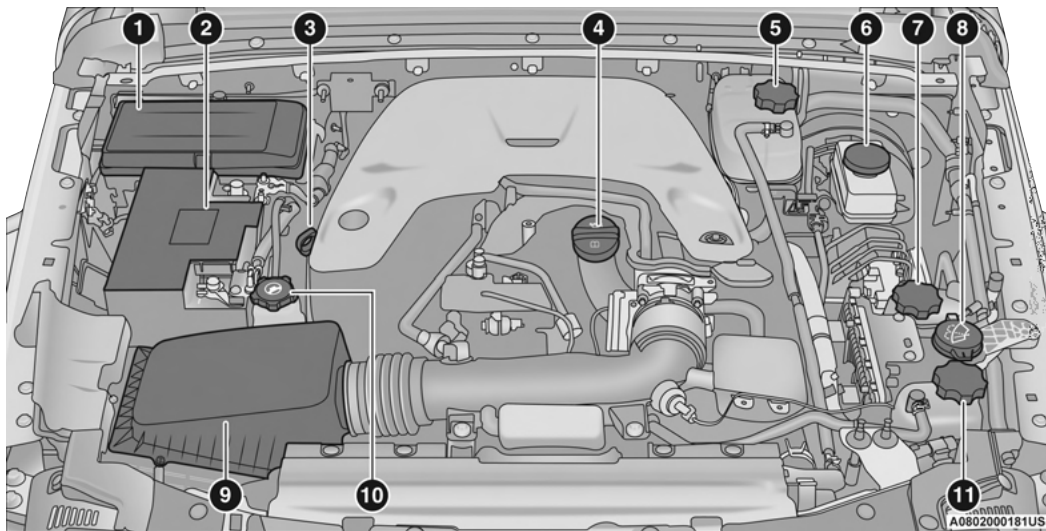

1 – Power Distribution Center (Fuses)

2 – Battery

3 – Engine Oil Dipstick

4 – Engine Oil Fill

5 – Engine Coolant Pressure Cap

6 – Brake Fluid Reservoir Cap

7 – Power Pack Unit Pressure Cap – If Equipped

8 – Washer Fluid Reservoir Cap

9 – Engine Air Cleaner Filter

10 – Power Steering Reservoir Cap

11 – Motor Generator Unit Coolant Pressure Cap– If Equipped

### 3.0L DIESEL ENGINE

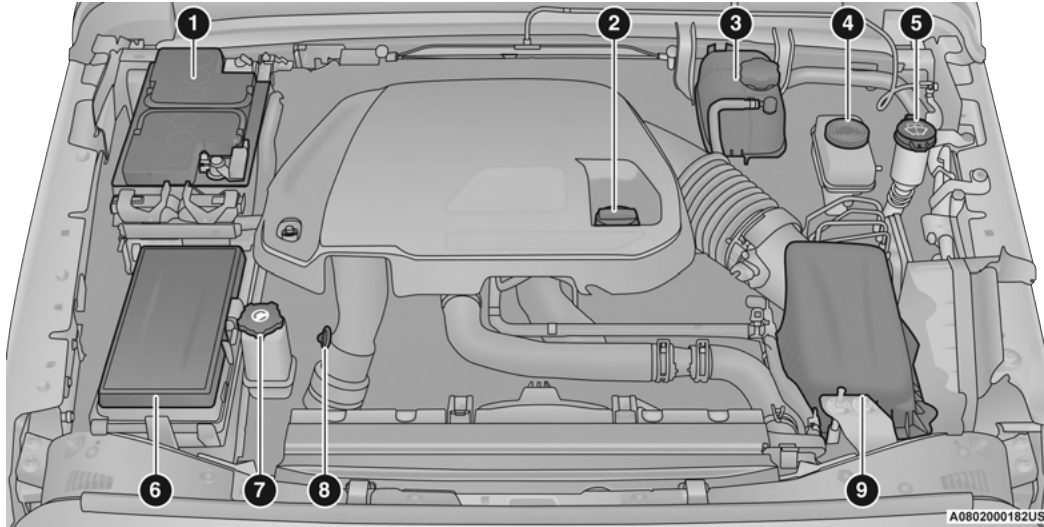

1 – Battery

2 – Engine Oil Fill

3 – Engine Coolant Pressure Reservoir

4 – Brake Fluid Reservoir Cap

5 – Washer Fluid Reservoir Cap

6 – Power Distribution Center (Fuses)

7 – Power Steering Reservoir Cap

8 – Engine Oil Dipstick

9 – Engine Air Cleaner Filter

## CHECKING OIL LEVEL

To ensure proper engine lubrication, the engine oil must be maintained at the correct level. Check the oil level at regular intervals, such as every fuel stop. The best time to check the engine oil level is about five minutes after a fully warmed up engine is shut off.

Checking the oil while the vehicle is on level ground will improve the accuracy of the oil level readings.

There are four possible dipstick types:

- Crosshatched zone.
- Crosshatched zone marked SAFE.
- Crosshatched zone marked with MIN at the low end of the range and MAX at the high end of the range.
- Crosshatched zone marked with dimples at the MIN and the MAX ends of the range.

### NOTE:

Always maintain the oil level within the crosshatch markings on the dipstick.

### NOTE:

Use care when filling under hood fluids such as engine oil, washer fluid, antifreeze, etc., to minimize spillage onto the top of the engine. Any excess fluid that is spilled onto the top of the engine should be removed using compressed air or an absorbent cloth.

Adding 1 quart (1 liter) of oil when the reading is at the low end of the dipstick range will raise the oil level to the high end of the range marking.

### CAUTION!

Overfilling or underfilling the crankcase will cause aeration or loss of oil pressure. This could damage your engine.

## ADDING WASHER FLUID

The fluid reservoir for the windshield washers and the rear window washer (if equipped) is shared. The fluid reservoir is located in the engine compartment. Be sure to check the fluid level at regular intervals. Fill the reservoir with windshield washer solvent only (not radiator antifreeze). When refilling the washer fluid reservoir, take some washer fluid and apply it to a cloth or towel and wipe clean the wiper blades; this will help blade performance.

To prevent freeze-up of your windshield washer system in cold weather, select a solution or mixture that meets or exceeds the temperature range of your climate. This rating information can be found on most washer fluid containers.

### NOTE:

Use care when filling under hood fluids such as engine oil, washer fluid, antifreeze, etc., to minimize spillage onto the top of the engine. Any excess fluid that is spilled onto the top of the engine should be removed using compressed air or an absorbent cloth.

### WARNING!

Commercial windshield washer solvents are flammable. They could ignite and burn you. Care must be exercised when filling or working around the washer solution.

## MAINTENANCE-FREE BATTERY

Your vehicle is equipped with a maintenance-free battery. You will never have to add water, and periodic maintenance is not required.

### WARNING!

- Battery fluid is a corrosive acid solution and can burn or even blind you. Do not allow battery fluid to contact your eyes, skin, or clothing. Do not lean over a battery when attaching clamps. If acid splashes in eyes or on skin, flush the area immediately with large amounts of water → page 338.

*(Continued)*



**WARNING!**

- Battery gas is flammable and explosive. Keep flame or sparks away from the battery. Do not use a booster battery or any other booster source with an output greater than 12 Volts. Do not allow cable clamps to touch each other.
- Battery posts, terminals, and related accessories contain lead and lead compounds. Wash hands after handling.
- Vehicles with the Stop/Start system will be equipped with two batteries. Both the main and the supplemental batteries must be disconnected to completely de-energize the 12 Volt electrical system.
- Serious injury or death could result if you do not disconnect both batteries. To learn how to properly disconnect, see an authorized dealer.

**CAUTION!**

- It is essential when replacing the cables on the battery that the positive cable is attached to the positive post and the negative cable is attached to the negative post. Battery posts are marked positive (+) and negative (-) and are identified on the battery case. Cable clamps should be tight on the terminal posts and free of corrosion.
- If a "fast charger" is used while the battery is in the vehicle, disconnect both vehicle battery cables before connecting the charger to the battery. Do not use a "fast charger" to provide starting voltage.
- Vehicles with the Stop/Start system will be equipped with two batteries. Both the main and the supplemental batteries must be disconnected to completely de-energize the 12 Volt electrical system.
- If the negative battery cables are not isolated properly it can cause a potential power spike or surge in the system, resulting in damage to essential electrical components.

**PRESSURE WASHING**

Cleaning the engine compartment with a high pressure washer is not recommended.

**CAUTION!**

Precautions have been taken to safeguard all parts and connections however, the pressures generated by these machines is such that complete protection against water ingress cannot be guaranteed.

**VEHICLE MAINTENANCE**

An authorized dealer has the qualified service personnel, special tools, and equipment to perform all service operations in an expert manner. Service Manuals are available which include detailed service information for your vehicle. Refer to these Service Manuals before attempting any procedure yourself.

**NOTE:**

Intentional tampering with emissions control systems may void your warranty and could result in civil penalties being assessed against you.

**WARNING!**

You can be badly injured working on or around a motor vehicle. Only do service work for which you have the knowledge and the proper equipment. If you have any doubt about your ability to perform a service job, take your vehicle to a competent mechanic.

**ENGINE OIL****Engine Oil Selection**

For engine oil selection ↗ page 424.

**American Petroleum Institute (API) Approved Engine Oil**

These symbols mean that the oil has been certified by the API. The manufacturer only recommends API trademark oils.



The API Starburst trademark certifies 0W-20, 0W-30 and 5W-30 engine oils.



The API Donut trademark certifies 0W-40 and 5W-40 engine oil.

**CAUTION!**

Do not use chemical flushes in your engine oil as the chemicals can damage your engine. Such damage is not covered by the New Vehicle Limited Warranty.

**Synthetic Engine Oils**

Your engine was designed for synthetic engine oils, only use synthetic API approved engine oils.

Synthetic engine oils which do not have both the correct API trademark and the correct SAE viscosity grade numbers should not be used.

**Materials Added To Engine Oil**

The manufacturer strongly recommends against the addition of any additives (other than leak detection dyes) to the engine oil. Engine oil is an engineered product and its performance may be impaired by supplemental additives.

**Disposing Of Used Engine Oil And Oil Filters**

Care should be taken in disposing of used engine oil and oil filters from your vehicle. Used oil and oil filters, indiscriminately discarded, can present a problem to the environment. Contact an authorized dealer, service station or governmental agency for advice on how and where used oil and oil filters can be safely discarded in your area.

**ENGINE OIL FILTER**

The engine oil filter should be replaced with a new filter at every engine oil change.

**Engine Oil Filter Selection**

A full-flow type disposable oil filter should be used for replacement. The quality of replacement filters varies considerably. Only high quality Mopar® filters should be used.

**ENGINE AIR CLEANER FILTER**

For the proper maintenance intervals ↗ page 348 for gasoline engines or ↗ page 352 for diesel engines.

**NOTE:**

Be sure to follow the "Severe Duty Conditions" maintenance interval if applicable.

**WARNING!**

The air induction system (air cleaner, hoses, etc.) can provide a measure of protection in the case of engine backfire. Do not remove the air induction system (air cleaner, hoses, etc.) unless such removal is necessary for repair or maintenance. Make sure that no one is near the engine compartment before starting the vehicle with the air induction system (air cleaner, hoses, etc.) removed. Failure to do so can result in serious personal injury.

### Engine Air Cleaner Filter Selection

The quality of replacement engine air cleaner filters varies considerably. Only high quality Mopar® filters should be used.

### Engine Air Cleaner Filter Inspection and Replacement— Gasoline Engine

Follow the recommended maintenance intervals as shown in the Maintenance Schedule in this section.

#### Engine Air Cleaner Filter Removal

1. Loosen the fasteners from the engine air cleaner filter cover using a suitable tool.

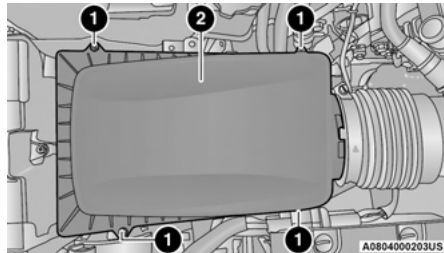

Engine Air Cleaner Filter Cover

- 1 — Fasteners  
2 — Engine Air Cleaner Filter Cover

2. Lift the engine air cleaner filter cover to access the engine air cleaner filter.
3. Remove the engine air cleaner filter from the housing assembly.

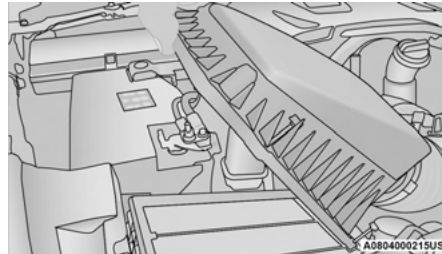

Engine Air Cleaner Filter Cover

#### Engine Air Cleaner Filter Installation

##### NOTE:

Inspect and clean the housing if significant dirt or debris is present before replacing the engine air cleaner filter.

1. Install the engine air cleaner filter into the housing assembly with the engine air cleaner filter inspection surface facing downward.
2. Tighten engine air cleaner filter cover fasteners using a suitable tool.

<b>CAUTION!</b>
Do not overtighten the engine air cleaner filter cover lid screws or damage may result.

### Engine Air Cleaner Filter Inspection and Replacement — Diesel Engine

Follow the recommended maintenance intervals as shown in the Maintenance Schedule in this section.

#### Engine Air Cleaner Filter Removal

1. Loosen the fasteners from the engine air cleaner filter cover using a suitable tool.

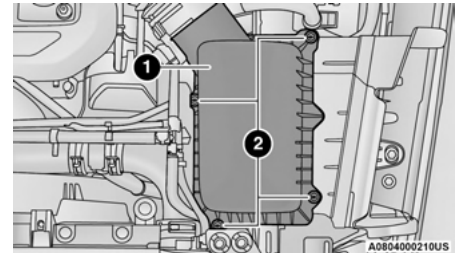

Engine Air Cleaner Filter Cover

- 1 — Engine Air Cleaner Filter Cover  
2 — Fasteners

- Lift the engine air cleaner filter cover to access the engine air cleaner filter.
- Remove the engine air cleaner filter from the housing assembly.

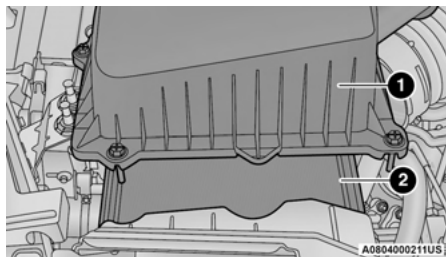
**Engine Air Cleaner Filter**

- Engine Air Cleaner Filter Cover
- Engine Air Cleaner Filter

**Engine Air Cleaner Filter Installation****NOTE:**

Inspect and clean the housing if significant dirt or debris is present before replacing the engine air cleaner filter.

- Install the engine air cleaner filter into the housing assembly with the engine air cleaner filter inspection surface facing downward.

- Tighten engine air cleaner filter cover fasteners using a suitable tool.

**CAUTION!**

Do not overtighten the engine air cleaner filter cover lid screws or damage may result.

**DRAINING FUEL/WATER SEPARATOR FILTER — DIESEL ENGINE**

The fuel/water separator housing is located inside the left frame rail in front of the fuel tank. The best access to this water drain valve is from under the vehicle.

**CAUTION!**

- Do not drain the fuel/water separator filter when the engine is running.
- Diesel fuel will damage blacktop paving surfaces. Drain the filter into an appropriate container.

If necessary remove the fuel filter protective cover to access the water drain valve.

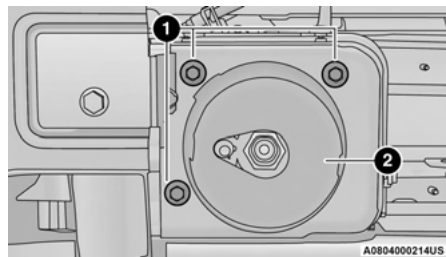
**Fuel/Water Separator Filter**

- Retainers
- Fuel Filter Protective Cover

If water is detected in the water separator while the engine is running, or while the ignition switch is in the ON position, the Water In Fuel Indicator Light will illuminate and an audible chime will be heard. At this point you should stop the engine and drain the water from the filter housing.

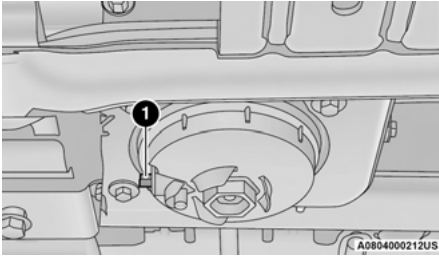
**Fuel/Water Separator Filter**

1 – Water In Fuel Drain Valve

Within 10 minutes of vehicle shutdown, turn the filter drain valve (located on the bottom of the filter housing) counterclockwise to drain fuel/water; allow the accumulated water to drain. Leave the drain valve open until all water and contaminants have been removed. When clear fuel is visible, close the drain valve by turning it clockwise.

Upon proper draining of the water from fuel filter assembly, the Water In Fuel Indicator Light will remain illuminated for approximately 10 seconds. If the water was drained while the engine was running, the Water In Fuel Indicator Light may remain on for approximately three minutes.

**NOTE:**

Care should be taken in disposing of used fluids from your vehicle. Used fluids, indiscriminately discarded, can present a problem to the environment. Contact an authorized dealer, service station, or government agency for advice on recycling programs and for where used fluids and filters can be properly disposed of in your area.

If more than two ounces or 60 ml of fuel have been drained, follow the directions for Priming If The Engine Has Run Out Of Fuel ↗ page 364.

## FUEL FILTER REPLACEMENT — DIESEL ENGINE

**NOTE:**

Using a fuel filter that does not meet the manufacturer's filtration and water separating requirements can severely impact fuel system life and reliability. We recommend you use Mopar® Fuel Filter. Must meet 3 micron rating.

**CAUTION!**

- Diesel fuel will damage blacktop paving surfaces. Drain the filter into an appropriate container.

(Continued)

**CAUTION!**

- Do not prefill the fuel filter when installing a new fuel filter. There is a possibility debris could be introduced into the fuel filter during this action. It is best to install the filter dry and allow the in-tank lift pump to prime the fuel system.

1. Ensure engine is turned off.
2. Remove the fuel filter protective cover to access the fuel filter assembly.

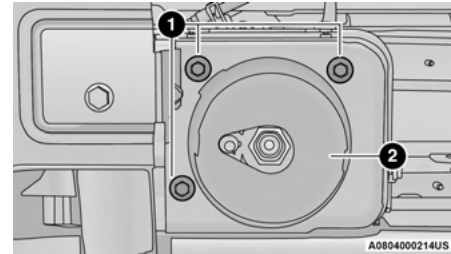
**Fuel Filter Assembly**

- 1 – Retainers
- 2 – Fuel Filter Protective Cover

- Place drain pan under the fuel filter assembly.
- Open the water drain valve, and let any accumulated water and fuel drain.
- Close the water drain valve.

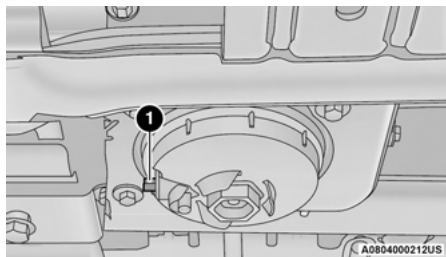

Fuel Filter Assembly

1 – Water Drain Valve

- Wipe clean the underside of the filter housing to prevent contamination from entering fuel system during service.
- Remove the fuel filter cap and filter from the housing using a socket. Rotate counter-clockwise for removal.

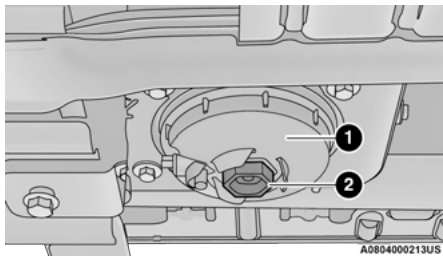

Fuel Filter Assembly

1 – Fuel Filter Cap  
2 – Socket Adapter

- Remove the used fuel filter cartridge from the cap and dispose of according to your local regulations.
- Wipe clean the sealing surfaces of the cap and housing.

#### CAUTION!

Take care when handling the new fuel filter to prevent contamination from entering the fuel system.

- Lubricate o-ring on the cap with clean engine oil.

- Install the new fuel filter cartridge onto the cap.
- Insert the cap and filter into the housing with clockwise rotation, use a socket to tighten.
- Push the ignition switch twice without your foot on the brake to place vehicle in RUN position. This will activate the in tank fuel pump for approximately 30 seconds. Repeat this process twice to prime the fuel system. Start the engine using the Normal Starting procedure. After engine start, verify the fuel filter cap does not leak.

### PRIMING IF THE ENGINE HAS RUN OUT OF FUEL — DIESEL ENGINE

#### WARNING!

Do not open the high pressure fuel system with the engine running. Engine operation causes high fuel pressure. High pressure fuel spray can cause serious injury or death.

- Add a substantial amount of fuel to the tank, approximately 2 to 5 gal (8L to 19L).
- Push ignition switch twice without your foot on brake to put vehicle in RUN position. This will activate the in tank fuel pump for approximately 30 seconds. Repeat this process twice to prime the fuel system.

3. Start the engine using the Normal Starting procedure ↪ page 143.

### CAUTION!

The starter motor will engage for approximately 30 seconds at a time. Allow two minutes between cranking intervals.

### NOTE:

The engine may run rough until the air is forced from all the fuel lines.

### WARNING!

Do not use alcohol or gasoline as a fuel blending agent. They can be unstable under certain conditions and be hazardous or explosive when mixed with diesel fuel.

### CAUTION!

Due to lack of lubricants in alcohol or gasoline, the use of these fuels can cause damage to the fuel system.

### NOTE:

- Use of biodiesel mixture in excess of 20% can negatively impact the fuel filter's ability to separate water from the fuel, resulting in high pressure fuel system corrosion or damage.
- In addition, commercially available fuel additives are not necessary for the proper operation of your diesel engine.
- For extreme cold conditions, "Mopar® Premium Diesel Fuel Treatment" is recommended to assist with cold starting.

## INTERVENTION REGENERATION STRATEGY — MESSAGE PROCESS FLOW

This engine meets all required diesel engine emissions standards. To achieve these emissions standards, your vehicle is equipped with a state-of-the-art engine and exhaust system. These systems are seamlessly integrated into your vehicle and managed by the Powertrain Control Module (PCM). The PCM manages engine combustion to allow the exhaust system's catalyst to trap and burn Particulate Matter (PM) pollutants, with no input or interaction on your part.

Additionally, your vehicle has the ability to alert you to additional maintenance required on your vehicle or engine.

Refer to Instrument Cluster Display for further information ↪ page 120.

### WARNING!

A hot exhaust system can start a fire if you park over materials that can burn. Such materials might be grass or leaves coming into contact with your exhaust system. Do not park or operate your vehicle in areas where your exhaust system can contact anything that can burn.

## DIESEL EXHAUST FLUID

Diesel Exhaust Fluid (DEF) sometimes known simply by the name of its active component, UREA—is a key component of Selective Catalytic Reduction (SCR) systems, which help diesel vehicles meet stringent emission regulations. DEF is a liquid reducing agent that reacts with engine exhaust in the presence of a catalyst to convert smog-forming Nitrogen Oxides (NOx) into harmless nitrogen and water vapor.

For further information ↪ page 424.

## ACCESSORY DRIVE BELT INSPECTION

### WARNING!

- Do not attempt to inspect an accessory drive belt with vehicle running.
- When working near the radiator cooling fan, disconnect the fan motor lead. The fan is temperature controlled and can start at any time regardless of ignition mode. You could be injured by the moving fan blades.
- You can be badly injured working on or around a motor vehicle. Only do service work for which you have the knowledge and the proper equipment. If you have any doubt about your ability to perform a service job, take your vehicle to a competent mechanic.

When inspecting accessory drive belts, small cracks that run across the ribbed surface of the belt, from rib to rib, are considered normal. These are not a reason to replace a belt. However, cracks running along a rib (not across) are not normal. Any belt with cracks running along a rib must be replaced. Also have the belt replaced if it has excessive wear, frayed cords, or severe glazing.

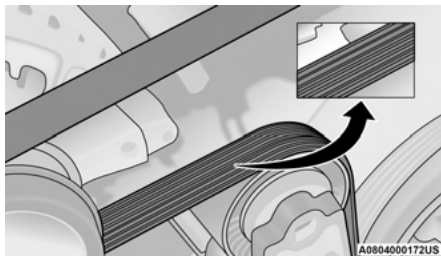

**Accessory Belt (Serpentine Belt)**

Conditions that would require replacement:

- Rib chunking (one or more ribs has separated from belt body)
- Rib or belt wear
- Longitudinal belt cracking (cracks between two ribs)
- Belt slips
- “Groove jumping” (belt does not maintain correct position on pulley)
- Belt broken
- Noise (objectionable squeal, squeak, or rumble is heard or felt while drive belt is in operation)

### NOTE:

Identify and correct problem before new belt is installed.

Some conditions can be caused by a faulty component such as a belt pulley. Belt pulleys should be carefully inspected for damage and proper alignment.

Belt replacement on some models requires the use of special tools, we recommend having your vehicle serviced at an authorized dealer.

## AIR CONDITIONER MAINTENANCE

For best possible performance, your air conditioner should be checked and serviced by an authorized dealer at the start of each warm season. This service should include cleaning of the condenser fins and a performance test. Drive belt tension should also be checked at this time.

### WARNING!

- Use only refrigerants and compressor lubricants approved by the manufacturer for your air conditioning system. Some unapproved refrigerants are flammable and can explode, injuring you. Other unapproved refrigerants or lubricants can cause the system to fail, requiring costly repairs. Refer to Warranty Information Book, located in your owner's information kit, for further warranty information.

*(Continued)*



**WARNING!**

- The air conditioning system contains refrigerant under high pressure. To avoid risk of personal injury or damage to the system, adding refrigerant or any repair requiring lines to be disconnected should be done by an experienced technician.

**CAUTION!**

Do not use chemical flushes in your air conditioning system as the chemicals can damage your air conditioning components. Such damage is not covered by the New Vehicle Limited Warranty.

### Refrigerant Recovery And Recycling — R-1234yf

R-1234yf Air Conditioning Refrigerant is a Hydrofluoroolefin (HFO) that is endorsed by the Environmental Protection Agency and is an ozone-friendly substance with a low global-warming potential. The manufacturer recommends that air conditioning service be performed by an authorized dealer using recovery and recycling equipment.

**NOTE:**

Use only the manufacturer approved A/C system PAG compressor oil, and refrigerants.

### Cabin Air Filter

**WARNING!**

Do not remove the cabin air filter while the vehicle is running, or while the ignition is in the ACC or ON/RUN mode. With the cabin air filter removed and the blower operating, the blower can contact hands and may propel dirt and debris into your eyes, resulting in personal injury.

The cabin air filter is located in the fresh air inlet behind the glove compartment. Perform the following procedure to replace the filter:

1. Open the glove compartment and remove all contents.
2. Push up on the glove compartment travel stop and lower the door.

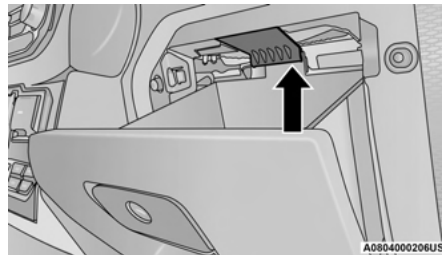

**Glove Compartment Travel Stop**

3. Pivot the glove compartment downward.
4. Disengage the two retaining tabs that secure the air filter access door to the HVAC housing.

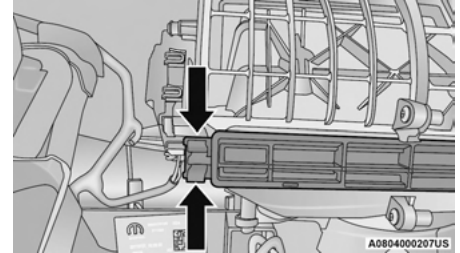

**Air Filter Retaining Tabs**

5. Remove the air filter from the HVAC air inlet housing. Pull the filter elements out pinching them to the right for clearance.

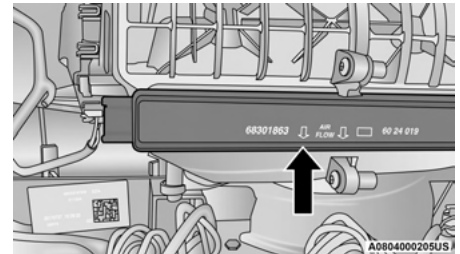

**Air Filter**

- Install the cabin air filter with the air filter position indicators pointing in the same direction as removal.

### CAUTION!

The cabin air filter is identified with an arrow to indicate airflow direction through the filter. Failure to properly install the filter will result in the need to replace it more often.

- Close cabin air filter access door and secure retaining tabs.
- Rotate the glove compartment door back into position ensuring you have properly engaged the travel dampener.

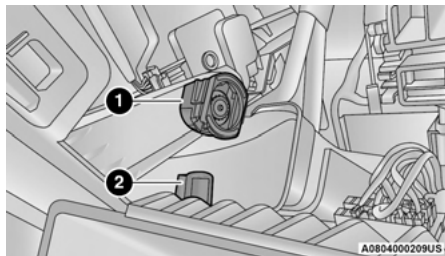

**Travel Dampener**

- Travel Dampener Housing
- Travel Dampener Rod

For the proper maintenance intervals, see [page 348](#) for gasoline engines or [page 352](#) for diesel engines.

## BODY LUBRICATION

Locks and all body pivot points, including such items as seat tracks, door hinge pivot points and rollers, liftgate, tailgate, decklid, sliding doors and hood hinges, should be lubricated periodically with a lithium based grease, such as Mopar® Spray White Lube to ensure quiet, easy operation and to protect against rust and wear. Prior to the application of any lubricant, the parts concerned should be wiped clean to remove dust and grit; after lubricating excess oil and grease should be removed. Particular attention should also be given to hood latching components to ensure proper function. When performing other underhood services, the hood latch release mechanism, and safety catch should be cleaned and lubricated.

The external lock cylinders should be lubricated twice a year, preferably in the Fall and Spring. Apply a small amount of a high quality lubricant, such as Mopar® Lock Cylinder Lubricant directly into the lock cylinder.

## WINDSHIELD WIPER BLADES

Clean the rubber edges of the wiper blades and the windshield periodically with a sponge or soft cloth and a mild nonabrasive cleaner. This will remove accumulations of salt or road film.

Operation of the wipers on dry glass for long periods may cause deterioration of the wiper blades. Always use washer fluid when using the wipers to remove salt or dirt from a dry windshield.

Avoid using the wiper blades to remove frost or ice from the windshield. Keep the blade rubber out of contact with petroleum products such as engine oil, gasoline, etc.

### NOTE:

Life expectancy of wiper blades varies depending on geographical area and frequency of use. Poor performance of blades may be present with chattering, marks, water lines or wet spots. If any of these conditions are present, clean the wiper blades or replace as necessary.

The wiper blades and wiper arms should be inspected periodically, not just when wiper performance problems are experienced. This inspection should include the following points:

- Wear or uneven edges
- Foreign material
- Hardening or cracking
- Deformation or fatigue

If a wiper blade or wiper arm is damaged, replace the affected wiper arm or blade with a new unit. Do not attempt to repair a wiper arm or blade that is damaged.

## Wiper Blade Removal/Installation

### CAUTION!

Do not allow the wiper arm to spring back against the glass without the wiper blade in place or the glass may be damaged.

1. Lift the wiper arm to raise the wiper blade off of the glass, until the wiper arm is in the full up position.

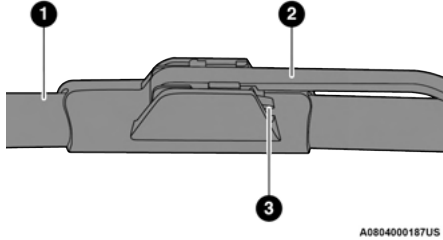

Wiper Blade With Release Tab In Locked Position

- 1 – Wiper Blade
- 2 – Wiper Arm
- 3 – Release Tab

2. To disengage the wiper blade from the wiper arm, push the release tab on the wiper blade and while holding the wiper arm with one hand, slide the wiper blade down towards the base of the wiper arm.

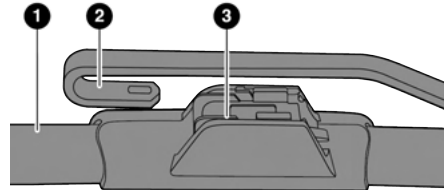

Wiper Blade With Release Tab In Unlocked Position

- 1 – Wiper Blade
  - 2 – Wiper Arm J Hook
  - 3 – J Hook Retainer
3. With the wiper blade disengaged, remove the wiper blade from the wiper arm.
  4. Gently lower the wiper arm onto the glass.

## Installing The Front Wipers

1. Lift the wiper arm off of the glass, until the wiper arm is in the full up position.
2. Position the wiper blade near the hook on the tip of the wiper arm.
3. Slide the wiper blade up into the hook on the wiper arm, latch engagement will be accompanied by an audible click.
4. Gently lower the wiper blade onto the glass.

## Rear Wiper Blade Removal/Installation

1. Open swing gate to access the wiper arm.

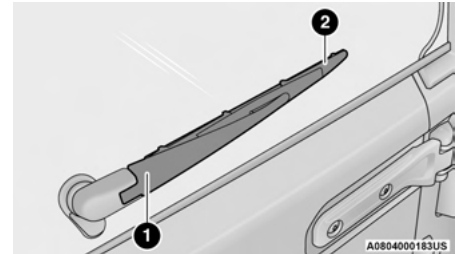

Rear Wiper Assembly

- 1 – Wiper Arm
- 2 – Wiper Blade

- Lift wiper arm off of the glass and rotate wiper blade outward to disengage the wiper blade from the wiper arm.

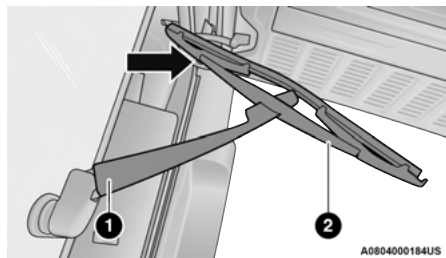

**Wiper Blade And Wiper Arm**

- Wiper Arm
- Wiper Blade

- Gently set the arm on the glass.

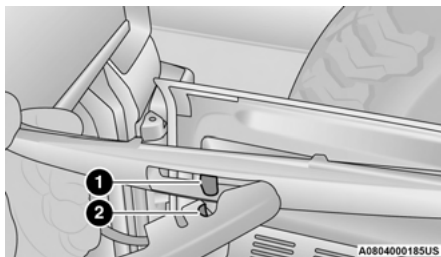

**Wiper Blade Removed From Wiper Arm**

- Wiper Blade Pivot Pin
- Wiper Arm Receptacle

### Installing The Rear Wiper

- Lift the wiper arm off of the glass.
- Insert the wiper blade pivot pin into the opening on the end of the wiper arm and rotate the wiper in to place.
- Place with wiper on the glass and close the tail gate.

## EXHAUST SYSTEM

The best protection against carbon monoxide entry into the vehicle body is a properly maintained engine exhaust system.

If you notice a change in the sound of the exhaust system; or if the exhaust fumes can be detected inside the vehicle; or when the underside or rear of the vehicle is damaged; have an authorized technician inspect the complete exhaust system and adjacent body areas for broken, damaged, deteriorated, or mispositioned parts. Open seams or loose connections could permit exhaust fumes to seep into the passenger compartment. In addition, have the exhaust system inspected each time the vehicle is raised for lubrication or oil change. Replace as required.

### WARNING!

- Exhaust gases can injure or kill. They contain Carbon Monoxide (CO), which is colorless and odorless. Breathing it can make you unconscious and can eventually poison you  
 ⇨ page 327.
- A hot exhaust system can start a fire if you park over materials that can burn. Such materials might be grass or leaves coming into contact with your exhaust system. Do not park or operate your vehicle in areas where your exhaust system can contact anything that can burn.

**CAUTION!**

- The catalytic converter requires the use of unleaded fuel only. Leaded gasoline will destroy the effectiveness of the catalyst as an emissions control device and may seriously reduce engine performance and cause serious damage to the engine.
- Damage to the catalytic converter can result if your vehicle is not kept in proper operating condition. In the event of engine malfunction, particularly involving engine misfire or other apparent loss of performance, have your vehicle serviced promptly. Continued operation of your vehicle with a severe malfunction could cause the converter to overheat, resulting in possible damage to the converter and vehicle.

Under normal operating conditions, the catalytic converter will not require maintenance. However, it is important to keep the engine properly tuned to ensure proper catalyst operation and prevent possible catalyst damage.

**NOTE:**

Intentional tampering with emissions control systems can result in civil penalties being assessed against you.

In unusual situations involving grossly malfunctioning engine operation, a scorching odor may suggest severe and abnormal catalyst overheating. If this occurs, stop the vehicle, turn off the engine and allow it to cool. Service, including a tune-up to manufacturer's specifications, should be obtained immediately.

To minimize the possibility of catalytic converter damage:

- Do not interrupt the ignition when the transmission is in gear and the vehicle is in motion.
- Do not try to start the vehicle by pushing or towing the vehicle.
- Do not idle the engine with any ignition components disconnected or removed, such as when diagnostic testing, or for prolonged periods during very rough idle or malfunctioning operating conditions.

**COOLING SYSTEM****WARNING!**

- You or others can be badly burned by hot engine coolant (antifreeze) or steam from your radiator. If you see or hear steam coming from under the hood, do not open the hood until the radiator has had time to cool. Never open a cooling system pressure cap when the radiator or coolant bottle is hot.

*(Continued)*

**WARNING!**

- Keep hands, tools, clothing, and jewelry away from the radiator cooling fan when the hood is raised. The fan starts automatically and may start at any time, whether the engine is running or not.
- When working near the radiator cooling fan, disconnect the fan motor lead or turn the ignition to the OFF mode. The fan is temperature controlled and can start at any time the ignition is in the ON mode.

**Coolant Checks**

Check the engine, battery (if equipped), intercooler (if equipped), and Motor Generator Unit (MGU) (if equipped) coolant (antifreeze) protection every 12 months (before the onset of freezing weather, where applicable). If the engine, battery (if equipped), intercooler (if equipped), and MGU (if equipped) coolant is dirty or rusty in appearance, the system should be drained, flushed and refilled with fresh OAT coolant (conforming to MS.90032) by an authorized dealer. Check the front of the A/C condenser (if equipped) or radiator for any accumulation of bugs, leaves, etc. If dirty, clean by gently spraying water from a garden hose vertically down the face of the A/C condenser (if equipped) or the back of the radiator core.

Check the engine, battery (if equipped), intercooler (if equipped), and MGU (if equipped) cooling system hoses for brittle rubber, cracking, tears, cuts, and tightness of the connection at the coolant recovery bottle and radiator. Inspect the entire system for leaks. **DO NOT REMOVE THE COOLANT PRESSURE CAP WHEN THE COOLING SYSTEM IS HOT.**

### Cooling System — Drain, Flush And Refill

#### NOTE:

Some vehicles require special tools to add coolant properly. Failure to fill these systems properly could lead to severe internal engine damage. If any coolant is needed to be added to the system please contact an authorized dealer.

If the engine coolant (antifreeze) is dirty or contains visible sediment, have an authorized dealer clean and flush with OAT coolant (conforming to MS.90032).

For the proper maintenance intervals, see

➤ page 348 for gasoline engines or ➤ page 352 for diesel engines.

### Selection Of Coolant

For further information ➤ page 424.

#### NOTE:

- Mixing of engine coolant (antifreeze) other than specified Organic Additive Technology (OAT) engine coolant, may result in engine damage

and may decrease corrosion protection. OAT engine coolant is different and should not be mixed with Hybrid Organic Additive Technology (HOAT) engine coolant or any “globally compatible” coolant. If a non-OAT engine coolant is introduced into the cooling system in an emergency, the cooling system will need to be drained, flushed, and refilled with fresh OAT coolant (conforming to MS.90032), by an authorized dealer as soon as possible.

- Do not use water alone or alcohol-based engine coolant (antifreeze) products. Do not use additional rust inhibitors or anti-rust products, as they may not be compatible with the radiator engine coolant and may plug the radiator.
- This vehicle has not been designed for use with propylene glycol-based engine coolant. Use of propylene glycol-based engine coolant is not recommended.
- Some vehicles require special tools to add coolant properly. Failure to fill these systems properly could lead to severe internal engine damage. If any coolant is needed to be added to the system please contact an authorized dealer.

### Adding Coolant

Your vehicle has been built with an improved engine coolant (OAT coolant conforming to MS.90032) that allows extended maintenance intervals. This engine coolant (antifreeze) can be used up to 10 years or

150,000 miles (240,000 km) before replacement. To prevent reducing this extended maintenance period, it is important that you use the same engine coolant (OAT coolant conforming to MS.90032) throughout the life of your vehicle.

Please review these recommendations for using Organic Additive Technology (OAT) engine coolant that meets the requirements of the manufacturer Material Standard MS.90032. When adding engine coolant (antifreeze):

- We recommend using Mopar® Antifreeze/Coolant 10 Year/150,000 Mile (240,000 km) Formula OAT (Organic Additive Technology) that meets the requirements of the manufacturer Material Standard MS.90032.
- Mix a minimum solution of 50% OAT engine coolant that meets the requirements of the manufacturer Material Standard MS.90032 and distilled water. Use higher concentrations (not to exceed 70%) if temperatures below  $-34^{\circ}\text{F}$  ( $-37^{\circ}\text{C}$ ) are anticipated. Please contact an authorized dealer for assistance.
- Use only high purity water such as distilled or deionized water when mixing the water/engine coolant solution. The use of lower quality water will reduce the amount of corrosion protection in the engine cooling system.

**NOTE:**

- It is the owner's responsibility to maintain the proper level of protection against freezing according to the temperatures occurring in the area where the vehicle is operated.
- Use care when filling under hood fluids such as engine oil, washer fluid, antifreeze, etc., to minimize spillage onto the top of the engine. Any excess fluid that is spilled onto the top of the engine should be removed using compressed air or an absorbent cloth.
- Some vehicles require special tools to add coolant properly. Failure to fill these systems properly could lead to severe internal engine damage. If any coolant is needed to be added to the system, please contact an authorized dealer.
- Mixing engine coolant types is not recommended and can result in cooling system damage. If HOAT and OAT coolant are mixed in an emergency, have an authorized dealer drain, flush, and refill with OAT coolant (conforming to MS.90032) as soon as possible.

**Cooling System Pressure Cap**

The cap must be fully tightened to prevent loss of engine coolant (antifreeze), and to ensure that engine coolant will return to the radiator from the coolant expansion bottle/recovery tank if so equipped.

The cap should be inspected and cleaned if there is any accumulation of foreign material on the sealing surfaces.

**WARNING!**

- Do not open hot engine cooling system. Never add engine coolant (antifreeze) when the engine is overheated. Do not loosen or remove the cap to cool an overheated engine. Heat causes pressure to build up in the cooling system. To prevent scalding or injury, do not remove the pressure cap while the system is hot or under pressure.
- Do not use a pressure cap other than the one specified for your vehicle. Personal injury or engine damage may result.

**Disposal Of Used Coolant**

Used ethylene glycol-based coolant (antifreeze) OAT or HOAT, is a regulated substance requiring proper disposal. Check with your local authorities to determine the disposal rules for your community. To prevent ingestion by animals or children, do not store ethylene glycol-based coolant in open containers or allow it to remain in puddles on the ground, clean up any ground spills immediately. If ingested, seek emergency assistance immediately.

**Coolant Level**

The coolant bottle provides a quick visual method for determining that the coolant level is adequate. With the engine OFF and cold, the level of the engine coolant (antifreeze) in the bottle should be between the ranges indicated on the bottle.

The radiator normally remains completely full, so there is no need to remove the radiator/coolant pressure cap unless checking for engine coolant freeze point or replacing coolant. Advise your service attendant of this. As long as the engine operating temperature is satisfactory, the coolant bottle need only be checked once a month.

When additional engine coolant is needed to maintain the proper level, only OAT coolant that meets the requirements of the manufacturer Material Standard MS.90032 should be added to the coolant bottle. Do not overfill.

**Engine Coolant Level — 2.0L****WARNING!**

- Do not open hot engine cooling system. Never add engine coolant (antifreeze) when the engine is overheated. Do not loosen or remove the cap to cool an overheated engine. Heat causes pressure to build up in the cooling system. To prevent scalding or injury, do not remove the pressure cap while the system is hot or under pressure.

*(Continued)*

**WARNING!**

- Do not use a pressure cap other than the one specified for your vehicle. Personal injury or engine damage may result.

With the engine OFF and cold, the level of the engine coolant should be within the OK range between the ADD and FULL range on the dipstick.

1. Remove the cap with level dipstick from the engine coolant bottle.
2. Clean off the coolant from the dipstick.
3. Rest the cap on the opening of the coolant bottle without tightening the cap.
4. Remove the cap with dipstick and check the coolant level on the dipstick.

The radiator normally remains completely full, so there is no need to remove the radiator/coolant pressure cap unless checking for engine coolant freeze point or replacing coolant. Advise your service attendant of this. As long as the engine operating temperature is satisfactory, the coolant bottle need only be checked once a month.

When additional engine coolant is needed to maintain the proper level, only OAT coolant that meets the requirements of the manufacturer Material Standard MS.90032 should be added to the coolant bottle. Do not overfill.

**Cooling System Notes****NOTE:**

When the vehicle is stopped after a few miles/kilometers of operation, you may observe vapor coming from the front of the engine compartment. This is normally a result of moisture from rain, snow, or high humidity accumulating on the radiator and being vaporized when the thermostat opens, allowing hot engine coolant (antifreeze) to enter the radiator.

If an examination of your engine compartment shows no evidence of radiator or hose leaks, the vehicle may be safely driven. The vapor will soon dissipate.

- Do not overfill the coolant expansion bottle.
- Check the coolant freeze point in the radiator and in the coolant expansion bottle. If engine coolant needs to be added, the contents of the coolant expansion bottle must also be protected against freezing.
- If frequent engine coolant additions are required, the cooling system should be pressure tested for leaks.
- Maintain engine coolant concentration at a minimum of 50% OAT coolant (conforming to MS.90032) and distilled water for proper corrosion protection of your engine which contains aluminum components.

- Make sure that the coolant expansion bottle overflow hoses are not kinked or obstructed.
- Keep the front of the radiator clean. If your vehicle is equipped with air conditioning, keep the front of the condenser clean.
- Do not change the thermostat for Summer or Winter operation. If replacement is ever necessary, install **ONLY** the correct type thermostat. Other designs may result in unsatisfactory engine cooling performance, poor gas mileage, and increased emissions.

**BRAKE SYSTEM**

In order to ensure brake system performance, all brake system components should be inspected periodically. For the proper maintenance intervals ↗ page 348.

**WARNING!**

Riding the brakes can lead to brake failure and possibly a collision. Driving with your foot resting or riding on the brake pedal can result in abnormally high brake temperatures, excessive lining wear, and possible brake damage. You would not have your full braking capacity in an emergency.



## Fluid Level Check— Brake Master Cylinder

The fluid level of the master cylinder should be checked whenever the vehicle is serviced, or immediately if the Brake System Warning Light is on. If necessary, add fluid to bring level within the designated marks on the side of the reservoir of the brake master cylinder. Be sure to clean the top of the master cylinder area before removing cap. With disc brakes, fluid level can be expected to fall as the brake pads wear. Brake fluid level should be checked when pads are replaced. If the brake fluid is abnormally low, check the system for leaks ↪ page 426.

### WARNING!

- Use only the manufacturer recommended brake fluid ↪ page 426. Using the wrong type of brake fluid can severely damage your brake system and/or impair its performance. The proper type of brake fluid for your vehicle is also identified on the original factory installed hydraulic master cylinder reservoir.

*(Continued)*

### WARNING!

- To avoid contamination from foreign matter or moisture, use only new brake fluid or fluid that has been in a tightly closed container. Keep the master cylinder reservoir cap secured at all times. Brake fluid in an open container absorbs moisture from the air resulting in a lower boiling point. This may cause it to boil unexpectedly during hard or prolonged braking, resulting in sudden brake failure. This could result in a collision.
- Overfilling the brake fluid reservoir can result in spilling brake fluid on hot engine parts, causing the brake fluid to catch fire. Brake fluid can also damage painted and vinyl surfaces, care should be taken to avoid its contact with these surfaces.
- Do not allow petroleum-based fluid to contaminate the brake fluid. Brake seal components could be damaged, causing partial or complete brake failure. This could result in a collision.

## FRONT/REAR AXLE FLUID

For normal service, periodic fluid level checks are not required. When the vehicle is serviced for other reasons the exterior surfaces of the axle assembly should be inspected. If gear oil leakage is suspected inspect the fluid level.

### Fluid Level Check

Lubricant should be approximately 1/8 inch (3 mm) below the bottom edge of the oil fill hole.

### NOTE:

Make sure that the vehicle is level and supported by the axles.

### Adding Fluid

Add lubricant only at the fill hole and only to the level specified above.

### Selection Of Lubricant

Use only manufacturer recommended fluid ↪ page 426.

## TRANSFER CASE

### Fluid Level Check

The fluid level should be to the bottom edge of the fill hole when the vehicle is in a level position.

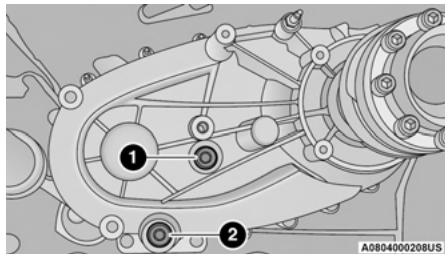

Transfer Case

- 1 – Fill hole
- 2 – Drain hole

### Drain And Refill

For the proper maintenance intervals ⇨ page 348.

### Selection Of Lubricant

Use only the manufacturer recommended fluid  
⇨ page 426.

## MANUAL TRANSMISSION — IF EQUIPPED

### Fluid Level Check

Check the fluid level by removing the fill plug. The fluid level should be between the bottom of the fill hole and a point not more than  $\frac{3}{16}$  of an inch (4.76 mm) below the bottom of the hole.

Add fluid, if necessary, to maintain the proper level.

### Frequency Of Fluid Change

Under normal operating conditions, the fluid installed at the factory will give satisfactory lubrication for the life of the vehicle. If the fluid becomes contaminated with water, it should be changed immediately. Otherwise, change the fluid as recommended in the Maintenance Plan. Refer to the Maintenance Plan for the proper maintenance intervals ⇨ page 348.

### Selection Of Lubricant

Use only the manufacturer recommended manual transmission fluid ⇨ page 426.

## AUTOMATIC TRANSMISSION —

### IF EQUIPPED

### Special Additives

It is strongly recommended against using any special additives in the transmission. Automatic Transmission Fluid (ATF) is an engineered product and its performance may be impaired by supplemental additives. Therefore, do not add any fluid additives to the transmission. Avoid using transmission sealers as they may adversely affect seals.

### CAUTION!

Do not use chemical flushes in your transmission as the chemicals can damage your transmission components. Such damage is not covered by the New Vehicle Limited Warranty.

## Fluid Level Check

The fluid level is preset at the factory and does not require adjustment under normal operating conditions. Routine fluid level checks are not required; therefore the transmission has no dipstick. An authorized dealer can check your transmission fluid level using special service tools. If you notice fluid leakage or transmission malfunction, visit an authorized dealer immediately to have the transmission fluid level checked. Operating the vehicle with an improper fluid level can cause severe transmission damage.

### CAUTION!

If a transmission fluid leak occurs, visit an authorized dealer immediately. Severe transmission damage may occur. An authorized dealer has the proper tools to adjust the fluid level accurately.

## Fluid And Filter Changes

Under normal operating conditions, the fluid installed at the factory will provide satisfactory lubrication for the life of the vehicle.

Routine fluid and filter changes are not required. However, change the fluid and filter if the fluid becomes contaminated (with water, etc.), or if the transmission is disassembled for any reason.

## Selection Of Lubricant

It is important to use the proper transmission fluid to ensure optimum transmission performance and life. Use only the manufacturer specified transmission fluid ↗ page 426. It is important to maintain the transmission fluid at the correct level using the recommended fluid.

### NOTE:

No chemical flushes should be used in any transmission; only the approved lubricant should be used.

### CAUTION!

Using a transmission fluid other than the manufacturer recommended fluid may cause deterioration in transmission shift quality and/or torque converter shudder ↗ page 426.

## FUSES

### General Information

#### WARNING!

- When replacing a blown fuse, always use an appropriate replacement fuse with the same amp rating as the original fuse. Never replace a fuse with another fuse of higher amp rating. The use of a fuse with a rating other than indicated may result in a dangerous electrical system overload. If a properly rated fuse continues to blow, it indicates a problem in the circuit that must be corrected. Never replace a blown fuse with metal wires or any other material. Failure to use proper fuses may result in serious personal injury, fire and/or property damage.
- Before replacing a fuse, make sure that the ignition is off and that all the other services are switched off and/or disengaged.
- If the replaced fuse blows again, contact an authorized dealer.

(Continued)

**WARNING!**

- If a general protection fuse for safety systems (air bag system, braking system), power unit systems (engine system, gearbox system) or steering system blows, contact an authorized dealer.

The fuses protect electrical systems against excessive current.

When a device does not work, you must check the fuse element inside the blade fuse for a break/melt.

Also, please be aware that using power outlets for extended periods of time with the engine off may result in vehicle battery discharge.

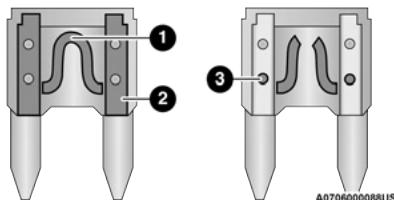
**Blade Fuses**

- 1 – Fuse Element
- 2 – Blade Fuse with a good/functional fuse element
- 3 – Blade fuse with a bad/not functional fuse element (blown fuse)

**Power Distribution Center (PDC)**

The Power Distribution Center is located in the engine compartment near the battery. This center contains cartridge fuses, mini fuses, and relays. The PDC top cover is labeled with each serviceable fuse/relay location, function, and size.

**CAUTION!**

When installing the power distribution center cover, it is important to ensure the cover is properly positioned and fully latched. Failure to do so may allow water to get into the power distribution center and possibly result in an electrical system failure.

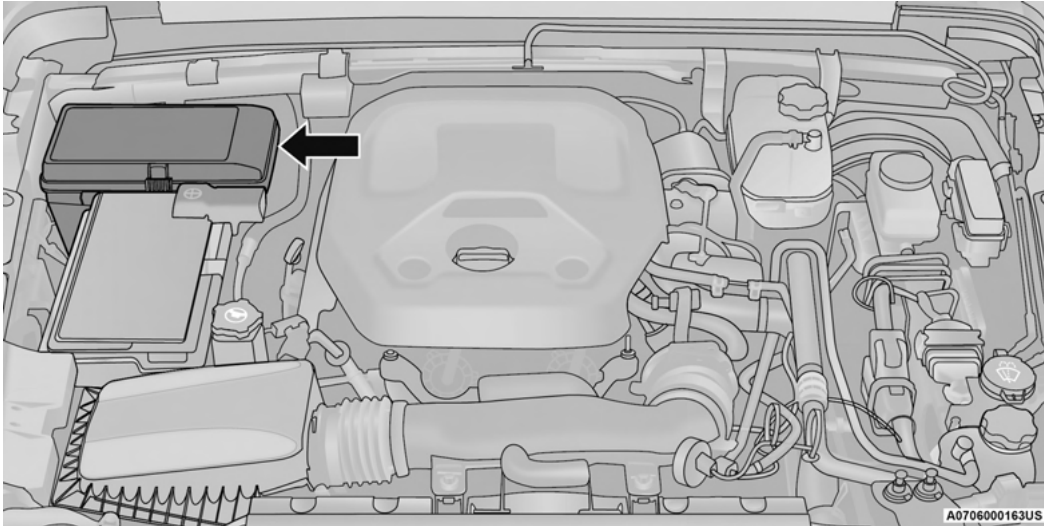

**Power Distribution Center Location - Gasoline Engine**

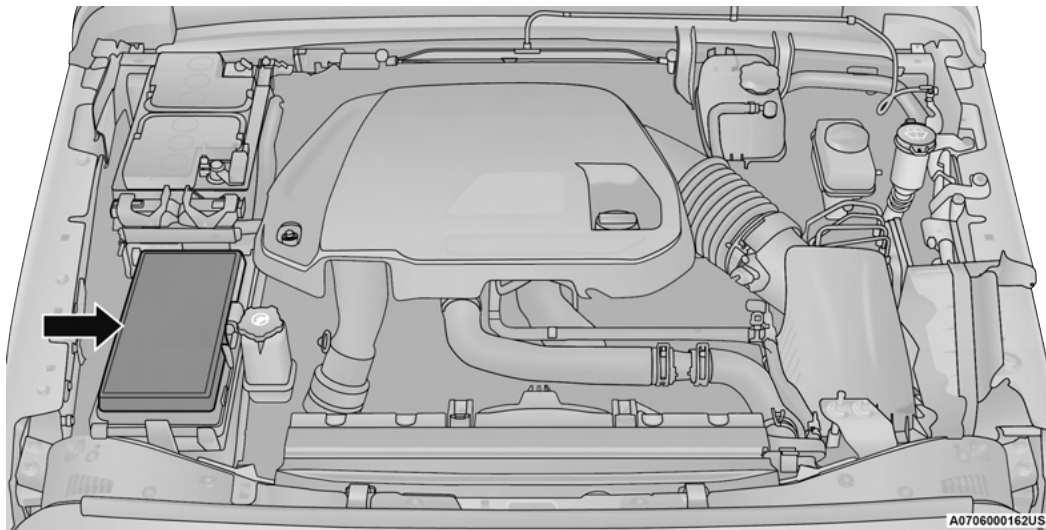

A0706000162US

**Power Distribution Center Location - Diesel Engine**

Cavity	Cartridge Fuse	Micro Fuse	Description
* If Equipped			
F01	-	-	Spare
F02	40 Amp Green	-	Starter
F03	-	5 Amp Tan	Intelligent Battery Sensor (IBS)

Cavity	Cartridge Fuse	Micro Fuse	Description
<b>* If Equipped</b>			
F04	-	20 Amp Yellow	Fuel Pump MTR/FPCM
		25 Amp Clear	Fuel Pmp (6.4)*
F05	-	5 Amp Tan	Security Gateway
F06	-	-	Spare
F07	-	15 Amp Blue	Low Temp Radiator Cooling Pump (LTR)*
F08	-	15 Amp Blue	Trans Control Module TCM-8HP CYGNUS
F09	-	-	Spare
F10	-	15 Amp Blue	Key Ignition Node (KIN)/Radio Frequency Hub (RF HUB)/ Electric Steering Column Lock (ESCL)
F11	-	10 Amp Red	UCI Port (USB & AUX)
F12	-	25 Amp Clear	HIFI Amplifier
F13	-	-	Spare
F14	-	-	Spare
F15	-	15 Amp Blue	Instrument Panel Cluster (IPC)/Switch Bank-Heavy Duty Electrical Pkg (SWITCH BANK-HD ELEC)
F16	-	-	Spare
F17	-	-	Spare
F18	-	10 Amp Red	Air Conditioning Clutch (AC CLUTCH)
F19	-	-	Spare
F20	30 Amp Pink	-	Central Body Controller (CBC) 1-INTERIOR LIGHTS
F21	-	20 Amp Yellow	REAR WIPER

Cavity	Cartridge Fuse	Micro Fuse	Description
<b>* If Equipped</b>			
F22	-	10 Amp Red	Engine Control Module (ECM)/Powertrain Control Module (PCM)/Motor Generator Unit (MGU) WAKE UP/Power Pack Unit (PPU) WAKE UP
F23	-	10 Amp Red	Powertrain Control Module (PCM)/Engine Control Module (ECM)
F24	-	-	Spare
F25	-	10 Amp Red	Module Shift By Wire (MOD_SBW)
F26	40 Amp Green	-	Central Body Controller (CBC) 2-EXTERIOR LIGHTS #1
F27	30 Amp Pink	-	Front Wipers
F28	40 Amp Green	-	Central Body Controller (CBC) 3-POWER LOCKS
F29	40 Amp Green	-	Central Body Controller (CBC) 4-EXTERIOR LIGHTS #2
F30	-	-	Spare
F31	-	10 Amp Red	DIAGNOSTIC PORT
F32	-	10 Amp Red	Heating Ventilation Air Conditioning Mod (HVAC CTRL MOD)/Steering Column Lock (SCL)/Occupant Classification Module (OCM)/Driver Presence Detection Module (DPDM)
F33	-	10 Amp Red	ParkTronics System (PTS)/Infrared Camera Module (IRCM)/Airbag Disable Lamps (AIRBAG DISABLE LMPS)
F34	-	10 Amp Red	Electronic Stability Control (ESC)/Electric Hydraulic Power Steering (EHPS)/Smart Bar Control Module (SBCM) WAKE UP
F35	30 Amp Pink	-	BRAKE VAC PMP*
F36	30 Amp Pink	-	TRAILER TOW ELEC BRK MOD*



Cavity	Cartridge Fuse	Micro Fuse	Description
<b>* If Equipped</b>			
F37	30 Amp Pink	-	TRAILER TOW CONN 7W*
F38	20 Amp Blue	-	Engine Control Module (ECM)
F39	-	15 Amp Blue	MGU Coolant Pump (3.6)*
F40	-	15 Amp Blue	DriveTrain Control Module (DTCM)/Axle Lock (AXLE LOC) FT_RR
F41	-	15 Amp Blue	Instrument Cluster (IC)/Security GateWay (SGW) WAKE UP
F42	-	10 Amp Red	Power Control Relay Control Feed (Electric Stop/Start)*
F43	-	20 Amp Yellow	PWR OUTLET (CARGO) BATT
F44	-	10 Amp Red	InfraRed Camera (IRCAM) HEATERS
F45	-	20 Amp Yellow	PWR OUTLET (CARGO) IGN
F46	-	10 Amp Red	AUTO HDLP LVL MOD/LVL MTR/HDLP SW
F47	-	-	Spare
F48	-	-	Spare
F49	-	10 Amp Red	Occupant Restraint Controller (ORC)
F50	-	10 Amp Red	HD ACC*
F51	-	10 Amp Red	Digital TV (DSRC)/USB/InSide RearView Mirror (ISRVM)/ Compass Module (CSGM)
F52	-	20 Amp Yellow	CIGAR LTR
F53	-	-	Spare
F54	-	-	Spare
F55	-	10 Amp Red	Central Vision Processing Module (CVPM)

Cavity	Cartridge Fuse	Micro Fuse	Description
<b>* If Equipped</b>			
F56	-	10 Amp Red	IN-CAR TEMP SENSOR/PTC HTR COIL FEED
F57	-	20 Amp Yellow	Driver Heated Seat
F58	-	20 Amp Yellow	Pass Heated Seat
F59	-	-	Spare
F60	-	15 Amp Blue	Comfort Steering Wheel Module (CSWM) (HTD STR WHEEL)
F61	-	10 Amp Red	Left Blind Spot Sensor (LBSS)/Right Blind Spot Sensor (RBSS)
F62	-	-	Spare
		10 Amp Red	Exhaust Sol*
F63	-	10 Amp Red	Occupant Restraint Controller (ORC)
F64	-	-	Spare
F65	-	-	Spare
F66	40 Amp Green	-	HVAC BLOWER MTR Front
F67	-	-	Spare
F68	-	-	Spare
F69	-	5 Amp Tan	Motor Generator Unit MGU Belt Starter Generator (BSG)*
F70	-	25 Amp Clear	INJ/IGN COIL (GAS)/GLO PLUG MOD (DSL)
F71	-	-	Spare
F72	-	10 Amp Red	HD ELEC ACC PKG*
F73	20 Amp Blue	-	PWR TOP LT
F74	20 Amp Blue	-	PWR TOP RT

Cavity	Cartridge Fuse	Micro Fuse	Description
<b>* If Equipped</b>			
F75	-	10 Amp Red	Power Pack Unit - Battery Pack Control Module & Auxiliary Power Module (PPU-BPCM & APM) Belt Starter Generator (BSG)*
F76	-	20 Amp Yellow	ECM (GAS)/PCM (DSL)
F77	-	10 Amp Red	HEATED MIRRORS
F78	-	10 Amp Red	INTRUSION MOD/SIREN/INTRUSION SENSORS
F79	-	20 Amp Yellow	SMART BAR CTRL MOD
F80	-	15 Amp Blue	Powertrain Control Module (PCM) / SOL 1,2 BLOCK SHIFT
		10 Amp Red	Vapor Blocking Valve (BSG)
F81	30 Amp Pink	-	Rear Defrost (Electric Backlight *
F82	30 Amp Pink	-	FUEL HTR*
F83	60 Amp Yellow	-	GLOW PLUG*
F84	30 Amp Pink	-	UREA HTR CTRL UNIT*
F85	-	10 Amp Red	PM SENSOR*
F86	30 Amp Pink	-	BRAKE VAC PMP 2*
F87	-	10 Amp Red	SUPPLY/PURGING PMP*
F88	20 Amp Blue	-	NOx SENSOR #1/ #2*
F89	-	10 Amp Red	Steering Column Control Module (SCCM)/ Cruise Control (CRUISE CTL)/Digital TV (DTV) / EVIC / Airbag Disable Lamp
F90	20 Amp Blue	-	TRAILER TOW PARK LMP*
F91	-	20 Amp Yellow	HORN

Cavity	Cartridge Fuse	Micro Fuse	Description
<b>* If Equipped</b>			
F92	40 Amp Green	-	HD ACCY #2*
F93	40 Amp Green	-	HD ACCY #1*
F94	-	-	Spare
F95	-	-	Spare
F96	-	10 Amp Red	PWR MIRROR SW
F97	-	20 Amp Yellow	RADIO/TBM
F98	-	10 Amp Red	SW BANK-HD ELEC/OFF ROAD
F99	-	-	Spare
F100	30 Amp Pink	-	ESC-ECU & VALVES
F101	30 Amp Pink	-	DriveTrain Control Module (DTCM)
F102	-	15 Amp Blue	DUAL USB PORT
F103	-	15 Amp Blue	HD ACCY #3*
F104	-	15 Amp Blue	PPU COOL PUMP*
F105	-	10 Amp Red	Integrated Center Stack (ICS)/Heat Ventilation Air Conditioning (HVAC)
F106	50 Amp Red	-	ESC -PUMP MTR
F107	-	20 Amp Yellow	TRAILER TOW STOP/TURN LT*
F108	-	15 Amp Blue	HD ACCY #4*
F109	-	20 Amp Yellow	TRAILER TOW STOP/TURN RT*

Cavity	Cartridge Fuse	Micro Fuse	Description
<b>* If Equipped</b>			
F110	30 Amp Pink	-	POWER INVERTER
F111	20 Amp Blue	-	TRAILER TOW BACKUP*

Customer can select to switch the Cargo Power Outlet from F43 battery fed power to this position F45 which is fed when the ignition is ON.

## BULB REPLACEMENT

### Replacement Bulbs, Names, And Part Numbers

In the instance a bulb needs to be replaced, this section includes bulb description and replacement part numbers.

#### NOTE:

See an authorized dealer for LED bulb replacement.

Interior Bulbs	
Bulb Name	Bulb Number
Automatic Transmission Indicator Lamp	658
Heater Control Lamps (2)	194
Rocker Switch Indicator Lamp (Rear Window Defogger, and Rear Wash/Wipe)	**
Soundbar Dome Lamp	912

\*\* Bulbs only available from an authorized dealer.

<b>Exterior Bulbs</b>	
<b>Bulb Name</b>	<b>Bulb Number</b>
Headlamps (2)	H13
Premium Head Lamps	LED
Sport Front Park/Turn Signal Lamps (2)	7444NALL
Premium Front Park/Turn Signal Lamps (2)	LED
Base (Sahara/Rubicon) Turn Lamp	7440NALL/WY21WLL
Base (Sahara/Rubicon) Park DRL Lamp	7443LL
Front Side Marker Lamps (2)	LED
Base Fog Lamps	PSX24W
Premium Fog Lamps	LED
Rear Premium LED Tail Lamps	LED
Rear Base Tail Lamp Stop/Tail/Turn Bulb	3157
Rear Base Tail Lamp Backup Bulb	7440
Rear Base Tail Lamp Side Marker	LED
Center High Mounted Stop Lamp (CHMSL)	LED
License Lamp	LED
<b>NOTE:</b> Numbers refer to commercial bulb types that can be purchased from an authorized dealer. If a bulb needs to be replaced, visit an authorized dealer or refer to the applicable Service Manual.	

## Bulb Replacement

### NOTE:

Lens fogging can occur under certain atmospheric conditions. This will usually clear as atmospheric conditions change to allow the condensation to change back into a vapor. Turning the lamps on will usually accelerate the clearing process.

### HALOGEN HEADLAMPS — IF EQUIPPED

See the following steps to replace:

1. Open hood and support using prop rod.
2. Remove the front grille. Turn the retainers along the top a quarter turn counterclockwise and remove.
3. Pull the bottom of the grille away starting at one side and working toward the other.
4. Remove the three screws holding the headlamp to the vehicle.
5. Remove lamp from the vehicle.
6. Remove the lamp from the collar.
7. Grab the bulb and rotate a quarter turn counterclockwise.
8. Pull the bulb from the housing.
9. Push connector locking tab to the unlock position.
10. Remove connector from bulb.

11. Push connector onto new bulb base, and push the connector locking tab to the lock position.

### CAUTION!

Do not touch the new bulb with your fingers. Oil contamination will severely shorten bulb life. If the bulb comes in contact with any oily surface, clean the bulb with rubbing alcohol.

12. Reinstall bulb housing. Rotate the bulb a quarter turn clockwise.

### FRONT PARK/TURN SIGNAL — IF EQUIPPED

See the following steps to replace:

1. Remove the front wheel liner fasteners to access bulb sockets.

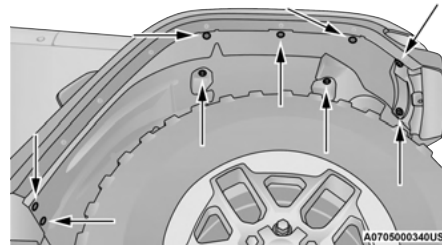

Wheel Liner

2. Turn the socket assembly a quarter turn counterclockwise and remove from housing. Pull the bulb straight from the socket to replace.

### LED FRONT SIDE MARKER — IF EQUIPPED

See the following steps to replace:

1. Remove the front wheel liner fasteners to access side maker screw and electrical connector.
2. Remove fastening screw in the back of the front side maker assembly and disconnect electrical connector.
3. Remove and replace LED front side marker light assembly.

### HALOGEN FRONT FOG LAMP — IF EQUIPPED

See the following steps to replace:

1. Reach under the vehicle to access the back of the front fog lamp.
2. Disconnect the wire harness connector from the front fog lamp connector receptacle.
3. Firmly grab the bulb by the two latch features and squeeze them together to unlock the bulb from the back of the front fog lamp housing.

- Pull the bulb straight out from the keyed opening in the housing and then connect the replacement bulb.

**CAUTION!**

Do not touch the new bulb with your fingers. Oil contamination will severely shorten bulb life. If the bulb comes in contact with any oily surface, clean the bulb with rubbing alcohol.

**LED Front Fog Lamp**

If your vehicle is equipped with LED fog lamps they are replaced as an assembly.

**REAR TAIL, STOP, TURN SIGNAL, AND BACKUP LAMP – IF EQUIPPED**

See the following steps to replace:

- Remove interior trim panel cap to access single retaining screw for tail lamp assembly.

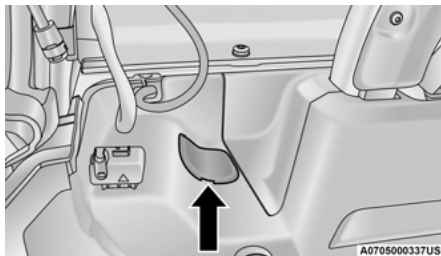
**Trim Cap**

- Remove retaining screw and disconnect electrical connector, then remove tail lamp assembly from the vehicle.

**NOTE:**

If necessary, push in on the assembly tab located inboard behind the lamp housing.

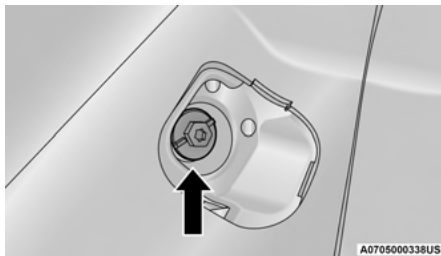
**Retaining Screw**

- Remove the three screws from assembly bracket to access bulb sockets.

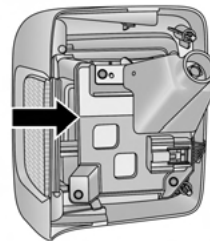
**Assembly Bracket**

- Rotate the appropriate socket a quarter turn counterclockwise, then remove it from the housing.
- Pull the bulb straight from the socket to replace.

**CENTER HIGH MOUNTED STOP LAMP (CHMSL) – IF EQUIPPED**

The stop lamp is mounted on a bracket that extends upward from the swing gate behind the spare tire. If service is needed, obtain the LED Assembly from an authorized dealer.



See the following steps to replace:

1. Remove the spare tire.
2. Remove the screws holding the tire carrier cover.
3. Remove two screws from lamp assembly and disconnect electrical connector.

### LICENSE PLATE LAMPS — IF EQUIPPED

See the following steps to replace:

#### NOTE:

To install a new bulb, reverse the procedure above. When installing the new bulb, care should be taken to not allow bare skin to come in contact with the bulb.

See an authorized dealer to replace LED lamps.

## TIRES

### TIRE SAFETY INFORMATION

Tire safety information will cover aspects of the following information: Tire Markings, Tire Identification Numbers, Tire Terminology and Definitions, Tire Pressures, and Tire Loading.

### Tire Markings

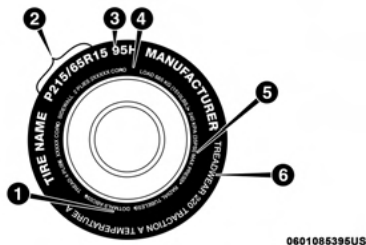

#### Tire Markings

- 1 — US DOT Safety Standards Code (TIN)
- 2 — Size Designation
- 3 — Service Description
- 4 — Maximum Load
- 5 — Maximum Pressure
- 6 — Treadwear, Traction and Temperature Grades

#### NOTE:

- P (Passenger) — Metric tire sizing is based on US design standards. P-Metric tires have the letter "P" molded into the sidewall preceding the size designation. Example: P215/65R15 95H.
- European — Metric tire sizing is based on European design standards. Tires designed to this standard have the tire size molded into the sidewall beginning with the section width. The letter "P" is absent from this tire size designation. Example: 215/65R15 96H.
- LT (Light Truck) — Metric tire sizing is based on US design standards. The size designation for LT-Metric tires is the same as for P-Metric tires except for the letters "LT" that are molded into the sidewall preceding the size designation. Example: LT235/85R16.
- Temporary spare tires are designed for temporary emergency use only. Temporary high pressure compact spare tires have the letter "T" or "S" molded into the sidewall preceding the size designation. Example: T145/80D18 103M.
- High flotation tire sizing is based on US design standards and it begins with the tire diameter molded into the sidewall. Example: 31x10.5 R15 LT.

## TIRE SIZING CHART

## EXAMPLE:

**Example Size Designation: P215/65R15XL 95H, 215/65R15 96H, LT235/85R16C, T145/80D18 103M, 31x10.5 R15 LT**

**P** = Passenger car tire size based on US design standards, or

**"...blank..."** = Passenger car tire based on European design standards, or

**LT** = Light truck tire based on US design standards, or

**T or S** = Temporary spare tire or

**31** = Overall diameter in inches (in)

**215, 235, 145** = Section width in millimeters (mm)

**65, 85, 80** = Aspect ratio in percent (%)

- Ratio of section height to section width of tire, or

**10.5** = Section width in inches (in)

**R** = Construction code

- "R" means radial construction, or
- "D" means diagonal or bias construction

**15, 16, 18** = Rim diameter in inches (in)

**Service Description:**

**95** = Load Index

- A numerical code associated with the maximum load a tire can carry

**H** = Speed Symbol

- A symbol indicating the range of speeds at which a tire can carry a load corresponding to its load index under certain operating conditions
- The maximum speed corresponding to the speed symbol should only be achieved under specified operating conditions (i.e., tire pressure, vehicle loading, road conditions, and posted speed limits)

**EXAMPLE:****Load Identification:**

Absence of the following load identification symbols on the sidewall of the tire indicates a Standard Load (SL) tire:

- **XL** = Extra load (or reinforced) tire, or
- **LL** = Light load tire or
- **C, D, E, F, G** = Load range associated with the maximum load a tire can carry at a specified pressure

**Maximum Load** – Maximum load indicates the maximum load this tire is designed to carry

**Maximum Pressure** – Maximum pressure indicates the maximum permissible cold tire inflation pressure for this tire

**Tire Identification Number (TIN)**

The TIN may be found on one or both sides of the tire; however, the date code may only be on one side. Tires with white sidewalls will have the full TIN, including the date code, located on the white sidewall side of the tire. Look for the TIN on the outboard side of black sidewall tires as mounted on the vehicle. If the TIN is not found on the outboard side, then you will find it on the inboard side of the tire.

**EXAMPLE:**

DOT MA L9 ABCD 0301

**DOT** = Department of Transportation

- This symbol certifies that the tire is in compliance with the US Department of Transportation tire safety standards and is approved for highway use

**MA** = Code representing the tire manufacturing location (two digits)

**L9** = Code representing the tire size (two digits)

**ABCD** = Code used by the tire manufacturer (one to four digits)

**03** = Number representing the week in which the tire was manufactured (two digits)

- 03 means the 3rd week

**EXAMPLE:**

**01** = Number representing the year in which the tire was manufactured (two digits)

- 01 means the year 2001
- Prior to July 2000, tire manufacturers were only required to have one number to represent the year in which the tire was manufactured. Example: 031 could represent the 3rd week of 1981 or 1991

**Tire Terminology And Definitions**

<b>Term</b>	<b>Definition</b>
<b>B-pillar</b>	The vehicle B-pillar is the structural member of the body located behind the front door.
<b>Cold Tire Inflation Pressure</b>	Cold tire inflation pressure is defined as the tire pressure after the vehicle has not been driven for at least three hours, or driven less than 1 mile (1.6 km) after sitting for a minimum of three hours. Inflation pressure is measured in units of PSI (pounds per square inch) or kPa (kilopascals).
<b>Maximum Inflation Pressure</b>	The maximum inflation pressure is the maximum permissible cold tire inflation pressure for this tire. The maximum inflation pressure is molded into the sidewall.
<b>Recommended Cold Tire Inflation Pressure</b>	Vehicle manufacturer's recommended cold tire inflation pressure as shown on the tire placard.
<b>Tire Placard</b>	A label permanently attached to the vehicle describing the vehicle's loading capacity, the original equipment tire sizes and the recommended cold tire inflation pressures.

## Tire Loading And Tire Pressure

### NOTE:

The proper cold tire inflation pressure is listed on the driver's side B-pillar or the rear edge of the driver's side door.

Check the inflation pressure of each tire, including the spare tire (if equipped), at least monthly and inflate to the recommended pressure for your vehicle.

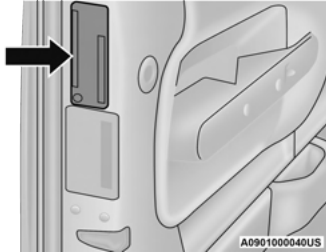

Example Tire Placard Location (Door)

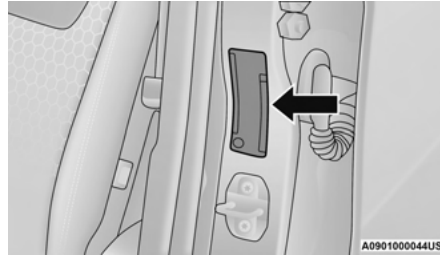

Example Tire Placard Location (B-pillar)

### Tire And Loading Information Placard



Tire And Loading Information Placard

This placard tells you important information about the:

1. Number of people that can be carried in the vehicle.
2. Total weight your vehicle can carry.
3. Tire size designed for your vehicle.
4. Cold tire inflation pressures for the front, rear, and spare tires.

### Loading

The vehicle maximum load on the tire must not exceed the load carrying capacity of the tire on your vehicle. You will not exceed the tire's load carrying capacity if you adhere to the loading conditions, tire size, and cold tire inflation pressures specified on the Tire and Loading Information placard ↪ page 191.

### NOTE:

Under a maximum loaded vehicle condition, Gross Axle Weight Rating (GAWR) for the front and rear axles must not be exceeded.

For further information on GAWR, vehicle loading, and trailer towing ↪ page 191.

To determine the maximum loading conditions of your vehicle, locate the statement “The combined weight of occupants and cargo should never exceed XXX kg or XXX lbs” on the Tire and Loading Information placard. The combined weight of occupants, cargo/luggage and trailer tongue weight (if applicable) should never exceed the weight referenced here.

### Steps For Determining Correct Load Limit—

- (1) Locate the statement “The combined weight of occupants and cargo should never exceed XXX kg or XXX lbs.” on your vehicle's placard.
- (2) Determine the combined weight of the driver and passengers that will be riding in your vehicle.
- (3) Subtract the combined weight of the driver and passengers from XXX kg or XXX lbs.

(4) The resulting figure equals the available amount of cargo and luggage load capacity. For example, if “XXX” amount equals 1400 lbs. and there will be five 150 lb passengers in your vehicle, the amount of available cargo and luggage load capacity is 650 lbs.  $(1400-750 (5 \times 150) = 650 \text{ lbs.})$

(5) Determine the combined weight of luggage and cargo being loaded on the vehicle. That weight may not safely exceed the available cargo and luggage load capacity calculated in Step 4.

(6) If your vehicle will be towing a trailer, load from your trailer will be transferred to your vehicle. Consult this manual to determine how this reduces the available cargo and luggage load capacity of your vehicle.

### Metric Example For Load Limit

For example, if “XXX” amount equals 635 kg and there will be five 68 kg passengers in your vehicle, the amount of available cargo and luggage load capacity is 295 kg  $(635-340 (5 \times 68) = 295 \text{ kg})$  as shown in step 4.

### NOTE:

- If your vehicle will be towing a trailer, load from your trailer will be transferred to your vehicle. The following table shows examples on how to calculate total load, cargo/luggage, and towing capacities of your vehicle with varying seating configurations and number and size of occupants. This table is for illustration purposes only and may not be accurate for the seating and load carry capacity of your vehicle.
- For the following example, the combined weight of occupants and cargo should never exceed 865 lb (392 kg).

Occupants			Combined weight of occupants and cargo from Tire Placard	MINUS	Combined Occupant's weight	=	AVAILABLE Cargo/Luggage and Trailer Tongue Weight
TOTAL	FRONT	REAR					
<b>EXAMPLE 1</b>			865 lbs	minus	Occupant 1: 200 lbs Occupant 2: 130 lbs Occupant 3: 160 lbs Occupant 4: 100 lbs Occupant 5: 80 lbs TOTAL WEIGHT: 670 lbs	=	195 lbs
5	2	3					
<b>EXAMPLE 2</b>			865 lbs	minus	Occupant 1: 210 lbs Occupant 2: 180 lbs Occupant 3: 150 lbs TOTAL WEIGHT: 540 lbs	=	325 lbs
3	2	1					
<b>EXAMPLE 3</b>			865 lbs	minus	Occupant 1: 200 lbs Occupant 2: 200 lbs TOTAL WEIGHT: 400 lbs	=	465 lbs
2	2	0					

811a4d11

**WARNING!**

Overloading of your tires is dangerous. Overloading can cause tire failure, affect vehicle handling, and increase your stopping distance. Use tires of the recommended load capacity for your vehicle. Never overload them.

## TIRES — GENERAL INFORMATION

### Tire Pressure

Proper tire inflation pressure is essential to the safe and satisfactory operation of your vehicle. Four primary areas are affected by improper tire pressure:

- Safety
- Fuel Economy
- Tread Wear
- Ride Comfort and Vehicle Stability

### Safety

#### WARNING!

- Improperly inflated tires are dangerous and can cause collisions.
- Underinflation increases tire flexing and can result in overheating and tire failure.
- Overinflation reduces a tire's ability to cushion shock. Objects on the road and chuckholes can cause damage that result in tire failure.
- Overinflated or underinflated tires can affect vehicle handling and can fail suddenly, resulting in loss of vehicle control.

(Continued)

#### WARNING!

- Unequal tire pressures can cause steering problems. You could lose control of your vehicle.
- Unequal tire pressures from one side of the vehicle to the other can cause the vehicle to drift to the right or left.
- Always drive with each tire inflated to the recommended cold tire inflation pressure.

Both underinflation and overinflation affect the stability of the vehicle and can produce a feeling of sluggish response or over responsiveness in the steering.

#### NOTE:

- Unequal tire pressures from side to side may cause erratic and unpredictable steering response.
- Unequal tire pressure from side to side may cause the vehicle to drift left or right.

#### Fuel Economy

Underinflated tires will increase tire rolling resistance resulting in higher fuel consumption.

### Tread Wear

Improper cold tire inflation pressures can cause abnormal wear patterns and reduced tread life, resulting in the need for earlier tire replacement.

### Ride Comfort And Vehicle Stability

Proper tire inflation contributes to a comfortable ride. Overinflation produces a jarring and uncomfortable ride.

### Tire Inflation Pressures

The proper cold tire inflation pressure is listed on the driver's side B-pillar or rear edge of the driver's side door.

At least once a month:

- Check and adjust tire pressure with a good quality pocket-type pressure gauge. Do not make a visual judgement when determining proper inflation. Tires may look properly inflated even when they are under-inflated.
- Inspect tires for signs of tire wear or visible damage.

#### CAUTION!

After inspecting or adjusting the tire pressure, always reinstall the valve stem cap. This will prevent moisture and dirt from entering the valve stem, which could damage the valve stem.



Inflation pressures specified on the placard are always “cold tire inflation pressure”. Cold tire inflation pressure is defined as the tire pressure after the vehicle has not been driven for at least three hours, or driven less than 1 mile (1.6 km) after sitting for a minimum of three hours. The cold tire inflation pressure must not exceed the maximum inflation pressure molded into the tire sidewall.

Check tire pressures more often if subject to a wide range of outdoor temperatures, as tire pressures vary with temperature changes.

Tire pressures change by approximately 1 psi (7 kPa) per 12 °F (7 °C) of air temperature change. Keep this in mind when checking tire pressure inside a garage, especially in the Winter.

Example: If garage temperature = 68 °F (20 °C) and the outside temperature = 32 °F (0 °C) then the cold tire inflation pressure should be increased by 3 psi (21 kPa), which equals 1 psi (7 kPa) for every 12 °F (7 °C) for this outside temperature condition.

Tire pressure may increase from 2 to 6 psi (13 to 40 kPa) during operation. DO NOT reduce this normal pressure build up or your tire pressure will be too low.

## Tire Pressures For High Speed Operation

The manufacturer advocates driving at safe speeds and within posted speed limits. Where speed limits or conditions are such that the vehicle can be driven at high speeds, maintaining correct tire inflation pressure is very important. Increased tire pressure and reduced vehicle loading may be required for high-speed vehicle operation. Refer to an authorized tire dealer or original equipment vehicle dealer for recommended safe operating speeds, loading and cold tire inflation pressures.

### WARNING!

High speed driving with your vehicle under maximum load is dangerous. The added strain on your tires could cause them to fail. You could have a serious collision. Do not drive a vehicle loaded to the maximum capacity at continuous speeds above 75 mph (120 km/h).

## Radial Ply Tires

### WARNING!

Combining radial ply tires with other types of tires on your vehicle will cause your vehicle to handle poorly. The instability could cause a collision. Always use radial ply tires in sets of four. Never combine them with other types of tires.

## Tire Repair

If your tire becomes damaged, it may be repaired if it meets the following criteria:

- The tire has not been driven on when flat.
- The damage is only on the tread section of your tire (sidewall damage is not repairable).
- The puncture is no greater than a ¼ of an inch (6 mm).

Consult an authorized tire dealer for tire repairs and additional information.

Damaged Run Flat tires, or Run Flat tires that have experienced a loss of pressure should be replaced immediately with another Run Flat tire of identical size and service description (Load Index and Speed Symbol). Replace the tire pressure sensor as well as it is not designed to be reused.

## Run Flat Tires — If Equipped

Run Flat tires allow you the capability to drive 50 miles (80 km) at 50 mph (80 km/h) after a rapid loss of inflation pressure. This rapid loss of inflation is referred to as the Run Flat mode. A Run Flat mode occurs when the tire inflation pressure is of/or below 14 psi (96 kPa). Once a Run Flat tire reaches the run flat mode it has limited driving capabilities and needs to be replaced immediately. A Run Flat tire is not repairable. When a run flat tire is changed after driving with underinflated tire

condition, please replace the TPMS sensor as it is not designed to be reused when driven under run flat mode 14 psi (96 kPa) condition.

#### NOTE:

TPMS sensor must be replaced after driving the vehicle on a flat tire condition.

It is not recommended driving a vehicle loaded at full capacity or to tow a trailer while a tire is in the run flat mode.

See the Tire Pressure Monitoring System section for more information.

### Tire Spinning

When stuck in mud, sand, snow, or ice conditions, do not spin your vehicle's wheels above 30 mph (48 km/h) or for longer than 30 seconds continuously without stopping.

For further information → page 343.

#### WARNING!

Fast spinning tires can be dangerous. Forces generated by excessive wheel speeds may cause tire damage or failure. A tire could explode and injure someone. Do not spin your vehicle's wheels faster than 30 mph (48 km/h) for more than 30 seconds continuously when you are stuck, and do not let anyone near a spinning wheel, no matter what the speed.

### Tread Wear Indicators

Tread wear indicators are in the original equipment tires to help you in determining when your tires should be replaced.

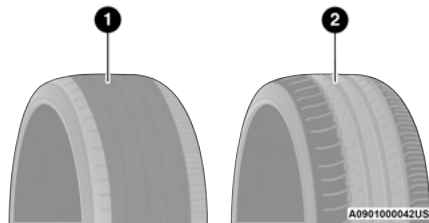

Tire Tread

1 – Worn Tire

2 – New Tire

These indicators are molded into the bottom of the tread grooves. They will appear as bands when the tread depth becomes a 1/16 of an inch (1.6 mm). When the tread is worn to the tread wear indicators, the tire should be replaced.

For further information → page 401.

### Life Of Tire

The service life of a tire is dependent upon varying factors including, but not limited to:

- Driving style.
- Tire pressure - Improper cold tire inflation pressures can cause uneven wear patterns to develop across the tire tread. These abnormal wear patterns will reduce tread life, resulting in the need for earlier tire replacement.
- Distance driven.
- Performance tires, tires with a speed rating of V or higher, and Summer tires typically have a reduced tread life. Rotation of these tires per the vehicle scheduled maintenance is highly recommended.

#### WARNING!

Tires and the spare tire should be replaced after six years, regardless of the remaining tread. Failure to follow this warning can result in sudden tire failure. You could lose control and have a collision resulting in serious injury or death.

**NOTE:**

Wheel valve stem must be replaced as well when installing new tires due to wear and tear in existing tires.

Keep dismounted tires in a cool, dry place with as little exposure to light as possible. Protect tires from contact with oil, grease, and gasoline.

**Replacement Tires**

The tires on your new vehicle provide a balance of many characteristics. They should be inspected regularly for wear and correct cold tire inflation pressures. The manufacturer strongly recommends that you use tires equivalent to the originals in size, quality and performance when replacement is needed. Refer to the paragraph on “Tread Wear Indicators” in this section. Refer to the Tire and Loading Information placard or the Vehicle Certification Label for the size designation of your tire. The Load Index and Speed Symbol for your tire will be found on the original equipment tire sidewall.

For more information relating to the Load Index and Speed Symbol of a tire ↪ page 392.

It is recommended to replace the two front tires or two rear tires as a pair. Replacing just one tire can seriously affect your vehicle’s handling. If you ever replace a wheel, make sure that the wheel’s specifications match those of the original wheels.

It is recommended you contact an authorized tire dealer or original equipment dealer with any questions you may have on tire specifications or capability. Failure to use equivalent replacement tires may adversely affect the safety, handling, and ride of your vehicle.

**WARNING!**

- Do not use a tire, wheel size, load rating, or speed rating other than that specified for your vehicle. Some combinations of unapproved tires and wheels may change suspension dimensions and performance characteristics, resulting in changes to steering, handling, and braking of your vehicle. This can cause unpredictable handling and stress to steering and suspension components. You could lose control and have a collision resulting in serious injury or death. Use only the tire and wheel sizes with load ratings approved for your vehicle.
- Never use a tire with a smaller load index or capacity, other than what was originally equipped on your vehicle. Using a tire with a smaller load index could result in tire overloading and failure. You could lose control and have a collision.

*(Continued)*

**WARNING!**

- Failure to equip your vehicle with tires having adequate speed capability can result in sudden tire failure and loss of vehicle control.

**CAUTION!**

Replacing original tires with tires of a different size may result in false speedometer and odometer readings.

**TIRE TYPES****All Season Tires — If Equipped**

All Season tires provide traction for all seasons (Spring, Summer, Autumn, and Winter). Traction levels may vary between different all season tires. All season tires can be identified by the M+S, M&S, M/S or MS designation on the tire sidewall. Use all season tires only in sets of four; failure to do so may adversely affect the safety and handling of your vehicle.

## Summer Or Three Season Tires — If Equipped

Summer tires provide traction in both wet and dry conditions, and are not intended to be driven in snow or on ice. If your vehicle is equipped with Summer tires, be aware these tires are not designed for Winter or cold driving conditions. Install Winter tires on your vehicle when ambient temperatures are less than 40°F (5°C) or if roads are covered with ice or snow. For more information, contact an authorized dealer.

Summer tires do not contain the all season designation or mountain/snowflake symbol on the tire sidewall. Use Summer tires only in sets of four; failure to do so may adversely affect the safety and handling of your vehicle.

### WARNING!

Do not use Summer tires in snow/ice conditions. You could lose vehicle control, resulting in severe injury or death. Driving too fast for conditions also creates the possibility of loss of vehicle control.

## Snow Tires

Some areas of the country require the use of snow tires during the Winter. Snow tires can be identified by a “mountain/snowflake” symbol on the tire sidewall.



If you need snow tires, select tires equivalent in size and type to the original equipment tires. Use snow tires only in sets of four; failure to do so may adversely affect the safety and handling of your vehicle.

Snow tires generally have lower speed ratings than what was originally equipped with your vehicle and should not be operated at sustained speeds over 75 mph (120 km/h). For speeds above 75 mph (120 km/h) refer to original equipment or an authorized tire dealer for recommended safe operating speeds, loading and cold tire inflation pressures.

While studded tires improve performance on ice, skid and traction capability on wet or dry surfaces may be poorer than that of non-studded tires. Some states prohibit studded tires; therefore, local laws should be checked before using these tire types.

## SPARE TIRES — IF EQUIPPED

### NOTE:

For vehicles equipped with Tire Service Kit instead of a spare tire, please refer to “Tire Service Kit” in “In Case Of Emergency” for further information.

### CAUTION!

Because of the reduced ground clearance, do not take your vehicle through an automatic car wash with a compact or limited use temporary spare installed. Damage to the vehicle may result.

For restrictions when towing with a spare tire designated for temporary emergency use  
 ⇨ page 195.

## Spare Tire Matching Original Equipped Tire And Wheel — If Equipped

Your vehicle may be equipped with a spare tire and wheel equivalent in look and function to the original equipment tire and wheel found on the front or rear axle of your vehicle. This spare tire may be used in the tire rotation for your vehicle. If your vehicle has this option, refer to an authorized tire dealer for the recommended tire rotation pattern.

### Compact Spare Tire — If Equipped

The compact spare is for temporary emergency use only. You can identify if your vehicle is equipped with a compact spare by looking at the spare tire description on the Tire and Loading Information Placard located on the driver's side door opening or on the sidewall of the tire. Compact spare tire descriptions begin with the letter "T" or "S" preceding the size designation. Example: T145/80D18 103M.

T, S = Temporary Spare Tire

Since this tire has limited tread life, the original equipment tire should be repaired (or replaced) and reinstalled on your vehicle at the first opportunity.

Do not install a wheel cover or attempt to mount a conventional tire on the compact spare wheel, since the wheel is designed specifically for the compact spare tire. Do not install more than one compact spare tire and wheel on the vehicle at any given time.

#### WARNING!

Compact and collapsible spares are for temporary emergency use only. With these spares, do not drive more than 50 mph (80 km/h). Temporary use spares have limited tread life. When the tread is worn to the tread wear indicators, the temporary use spare tire needs to be replaced. Be sure to follow the warnings, which apply to your spare. Failure to do so could result in spare tire failure and loss of vehicle control.

### Full Size Spare — If Equipped

The full size spare is for temporary emergency use only. This tire may look like the originally equipped tire on the front or rear axle of your vehicle, but it is not. This spare tire may have limited tread life. When the tread is worn to the tread wear indicators, the temporary use full size spare tire needs to be replaced. Since it is not the same as your original equipment tire, replace (or repair) the original equipment tire and reinstall on the vehicle at the first opportunity.

### Limited Use Spare — If Equipped

The limited use spare tire is for temporary emergency use only. This tire is identified by a label located on the limited use spare wheel. This label contains the driving limitations for this spare. This tire may look like the original equipped tire on the front or rear axle of your vehicle, but it is not. Installation of this limited use spare tire affects vehicle handling. Since it is not the same as your original equipment tire, replace (or repair) the original equipment tire and reinstall on the vehicle at the first opportunity.

#### WARNING!

Limited use spares are for emergency use only. Installation of this limited use spare tire affects vehicle handling. With this tire, do not drive more than the speed listed on the limited use spare wheel. Keep inflated to the cold tire inflation pressures listed on your Tire and Loading Information Placard located on the driver's side B-pillar or the rear edge of the driver's side door. Replace (or repair) the original equipment tire at the first opportunity and reinstall it on your vehicle. Failure to do so could result in loss of vehicle control.

## WHEEL AND WHEEL TRIM CARE

All wheels and wheel trim, especially aluminum and chrome plated wheels, should be cleaned regularly using mild (neutral Ph) soap and water to maintain their luster and to prevent corrosion. Wash wheels with the same soap solution recommended for the body of the vehicle and remember to always wash when the surfaces are not hot to the touch.

Your wheels are susceptible to deterioration caused by salt, sodium chloride, magnesium chloride, calcium chloride, etc., and other road chemicals used to melt ice or control dust on dirt roads. Use a soft cloth or sponge and mild soap to wipe away promptly. Do not use harsh chemicals or a stiff brush. They can damage the wheel's protective coating that helps keep them from corroding and tarnishing.

### CAUTION!

Avoid products or automatic car washes that use acidic solutions or strong alkaline additives or harsh brushes. Many aftermarket wheel cleaners and automatic car washes may damage the wheel's protective finish. Such damage is not covered by the New Vehicle Limited Warranty. Only car wash soap, Mopar® Wheel Cleaner or equivalent is recommended.

When cleaning extremely dirty wheels including excessive brake dust, care must be taken in the selection of tire and wheel cleaning chemicals and equipment to prevent damage to the wheels. Mopar® Wheel Treatment or Mopar® Chrome Cleaner or their equivalent is recommended or select a non-abrasive, non-acidic cleaner for aluminum or chrome wheels.

### CAUTION!

Do not use scouring pads, steel wool, a bristle brush, metal polishes or oven cleaner. These products may damage the wheel's protective finish. Such damage is not covered by the New Vehicle Limited Warranty. Only car wash soap, Mopar® Wheel Cleaner or equivalent is recommended.

### NOTE:

If you intend parking or storing your vehicle for an extended period after cleaning the wheels with wheel cleaner, drive your vehicle and apply the brakes to remove the water droplets from the brake components. This activity will remove the red rust on the brake rotors and prevent vehicle vibration when braking.

## Dark Vapor Chrome, Black Satin Chrome, or Low Gloss Clear Coat Wheels

### CAUTION!

If your vehicle is equipped with these specialty wheels, DO NOT USE wheel cleaners, abrasives, or polishing compounds. They will permanently damage this finish and such damage is not covered by the New Vehicle Limited Warranty. HAND WASH ONLY USING MILD SOAP AND WATER WITH A SOFT CLOTH. Used on a regular basis; this is all that is required to maintain this finish.

## SNOW TRACTION DEVICES

Use of traction devices require sufficient tire-to-body clearance. Due to limited clearance, the following snow traction devices are recommended. Follow these recommendations to guard against damage.

- Snow traction device must be of proper size for the tire, as recommended by the snow traction device manufacturer.
- No other tire sizes are recommended for use with the snow traction device.
- Please follow the table for the recommended tire size, axle and snow traction device:

Trim Level	Axle	Tire/Wheel Size	Snow Traction Device (maximum projection beyond tire profile or equivalent)
Sport	Rear	245/75R17	S Class or Autosock
Willy's		LT255/75R17C	Autosock
Sahara		255/70R18	
Rubicon		LT285/70R17C	
High Altitude		275/55R20	

### WARNING!

Using tires of different size and type (M+S, Snow) between front and rear axles can cause unpredictable handling. You could lose control and have a collision.

### CAUTION!

To avoid damage to your vehicle or tires, observe the following precautions:

(Continued)

### CAUTION!

- Because of restricted traction device clearance between tires and other suspension components, it is important that only traction devices in good condition are used. Broken devices can cause serious damage. Stop the vehicle immediately if noise occurs that could indicate device breakage. Remove the damaged parts of the device before further use.

(Continued)

### CAUTION!

- Install device as tightly as possible and then retighten after driving about ½ mile (0.8 km). Autosock traction devices do not require retightening.
- Do not exceed 30 mph (48 km/h).
- Drive cautiously and avoid severe turns and large bumps, especially with a loaded vehicle.

(Continued)

**CAUTION!**

- Do not drive for a prolonged period on dry pavement.
- Observe the traction device manufacturer's instructions on the method of installation, operating speed, and conditions for use. Always use the suggested operating speed of the device manufacturer's if it is less than 30 mph (48 km/h).
- Do not use traction devices on a compact spare tire.

**TIRE ROTATION RECOMMENDATIONS**

The tires on the front and rear of your vehicle operate at different loads and perform different steering, handling, and braking functions. For these reasons, they wear at unequal rates.

These effects can be reduced by timely rotation of tires. The benefits of rotation are especially worthwhile with aggressive tread designs such as those on On/Off Road type tires. Rotation will increase tread life, help to maintain mud, snow, and wet traction levels, and contribute to a smooth, quiet ride.

For the proper maintenance intervals ⇨ page 348. The reasons for any rapid or unusual wear should be corrected prior to rotation being performed.

The suggested rotation method is the "rearward cross" shown in the following diagram.

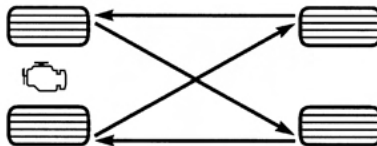

055703771

**Tire Rotation (Rearward Cross)****CAUTION!**

Proper operation of four-wheel drive vehicles depends on tires of equal size, type, and circumference on each wheel. Any difference in tire size can cause damage to the transfer case. Tire rotation schedule should be followed to balance tire wear.

**DEPARTMENT OF TRANSPORTATION  
UNIFORM TIRE QUALITY GRADES**

The following tire grading categories were established by the National Highway Traffic Safety Administration.

The specific grade rating assigned by the tire's manufacturer in each category is shown on the sidewall of the tires on your vehicle.

All passenger vehicle tires must conform to Federal safety requirements in addition to these grades.

**TREADWEAR**

The Treadwear grade is a comparative rating, based on the wear rate of the tire when tested under controlled conditions on a specified government test course. For example, a tire graded 150 would wear one and one-half times as well on the government course as a tire graded 100. The relative performance of tires depends upon the actual conditions of their use, however, and may depart significantly from the norm due to variations in driving habits, service practices, and differences in road characteristics and climate.

**TRACTION GRADES**

The Traction grades, from highest to lowest, are AA, A, B, and C. These grades



represent the tire's ability to stop on wet pavement, as measured under controlled conditions on specified government test surfaces of asphalt and concrete. A tire marked C may have poor traction performance.

#### WARNING!

The traction grade assigned to this tire is based on straight-ahead braking traction tests, and does not include acceleration, cornering, hydroplaning, or peak traction characteristics.

## TEMPERATURE GRADES

The Temperature grades are A (the highest), B, and C, representing the tire's resistance to the generation of heat and its ability to dissipate heat, when tested under controlled conditions on a specified indoor laboratory test wheel.

Sustained high temperature can cause the material of the tire to degenerate and reduce tire life, and excessive temperature can lead to sudden tire failure. The grade C corresponds to a level of performance, which all

passenger vehicle tires must meet under the Federal Motor Vehicle Safety Standard No. 109. Grades B and A represent higher levels of performance on the laboratory test wheel, than the minimum required by law.

#### WARNING!

The temperature grade for this tire is established for a tire that is properly inflated and not overloaded. Excessive speed, underinflation, or excessive loading, either separately or in combination, can cause heat buildup and possible tire failure.

## STORING THE VEHICLE

#### WARNING!

- Take care to avoid the radiator cooling fan whenever the hood is raised. It can start anytime the ignition switch is ON. You can be injured by moving fan blades.
- Remove any metal jewelry such as rings, watch bands and bracelets that could make an inadvertent electrical contact. You could be seriously injured.

*(Continued)*

#### WARNING!

- Vehicles with the Stop/Start system will be equipped with two batteries. Both the main and the supplemental batteries must be disconnected to completely de-energize the 12 Volt electrical system.
- Serious injury or death could result if you do not disconnect both batteries. To learn how to properly disconnect, see an authorized dealer.

#### CAUTION!

If the negative battery cables are not isolated properly it can cause a potential power spike or surge in the system, resulting in damage to essential electrical components.

If you are storing your vehicle for more than three weeks, we recommend that you take the following steps to minimize the drain on your vehicle's battery:

- Disconnect the negative cable from battery.
- If your vehicle is equipped with Stop/Start system then disconnect both the main and supplemental negative battery cables.
- Any time you store your vehicle or keep it out of service (i.e., vacation) for two weeks or more, run the air conditioning system at idle for about

five minutes in the fresh air and high blower setting. This will ensure adequate system lubrication to minimize the possibility of compressor damage when the system is started again.

- If assistance is needed to disconnect the battery system, see an authorized dealer.

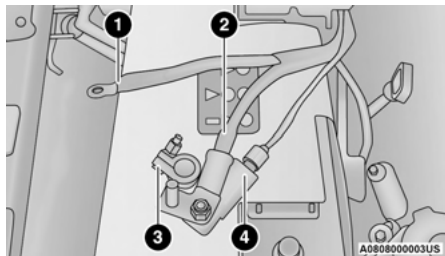

**Battery Cable Disconnect**

- 1 — Supplemental Negative Battery Cable
- 2 — Main Negative Battery Cable
- 3 — Main Negative Battery Terminal
- 4 — Intelligent Battery Sensor (IBS)

**NOTE:**

- You must isolate the supplemental battery connection point, as well as the main battery terminal from the post, as shown in the image, to fully de-energize both batteries for storage. If

assistance is needed to disconnect the battery system, see an authorized dealer.

- Do not disconnect the Intelligent Battery Sensor (IBS), or your Stop/Start system may not function for up to 24 hours, due to the IBS being set into learn mode.

## BODYWORK

### PROTECTION FROM ATMOSPHERIC AGENTS

Vehicle body care requirements vary according to geographic locations and usage. Chemicals that make roads passable in snow and ice and those that are sprayed on trees and road surfaces during other seasons are highly corrosive to the metal in your vehicle. Outside parking, which exposes your vehicle to airborne contaminants, road surfaces on which the vehicle is operated, extreme hot or cold weather and other extreme conditions will have an adverse effect on paint, metal trim, and underbody protection.

The following maintenance recommendations will enable you to obtain maximum benefit from the corrosion resistance built into your vehicle.

### What Causes Corrosion?

Corrosion is the result of deterioration or removal of paint and protective coatings from your vehicle.

The most common causes are:

- Road salt, dirt and moisture accumulation.
- Stone and gravel impact.
- Insects, tree sap and tar.
- Salt in the air near seacoast localities.
- Atmospheric fallout/industrial pollutants.

## BODY AND UNDERBODY MAINTENANCE

### Cleaning Headlights

Your vehicle is equipped with plastic headlights and fog lights that are lighter and less susceptible to stone breakage than glass headlights.

Plastic is not as scratch resistant as glass and therefore different lens cleaning procedures must be followed.

To minimize the possibility of scratching the lenses and reducing light output, avoid wiping with a dry cloth. To remove road dirt, wash with a mild soap solution followed by rinsing.

Do not use abrasive cleaning components, solvents, steel wool or other aggressive material to clean the lenses.

## PRESERVING THE BODYWORK

### Washing

- Wash your vehicle regularly. Always wash your vehicle in the shade using Mopar® Car Wash, or a mild car wash soap, and rinse the panels completely with water.
- If insects, tar, or other similar deposits have accumulated on your vehicle, use Mopar® Super Kleen Bug and Tar Remover to remove.
- Use a high quality cleaner wax, such as Mopar® Cleaner Wax to remove road film, stains and to protect your paint finish. Use precautions to not scratch the paint.
- Avoid using abrasive compounds and power buffing that may diminish the gloss or thin out the paint finish.

#### CAUTION!

- Do not use abrasive or strong cleaning materials such as steel wool or scouring powder that will scratch metal and painted surfaces.
- Use of power washers exceeding 1,200 psi (8,274 kPa) can result in damage or removal of paint and decals.

### Special Care

- If you drive on salted or dusty roads or if you drive near the ocean, hose off the undercarriage at least once a month.
- It is important that the drain holes in the lower edges of the doors, rocker panels, and trunk be kept clear and open.
- If you detect any stone chips or scratches in the paint, touch them up immediately. The cost of such repairs is considered the responsibility of the owner.
- If your vehicle is damaged due to a collision or similar cause that destroys the paint and protective coating, have your vehicle repaired as soon as possible. The cost of such repairs is considered the responsibility of the owner.
- If you carry special cargo such as chemicals, fertilizers, de-icer salt, etc., be sure that such materials are well packaged and sealed.
- If a lot of driving is done on gravel roads, consider mud or stone shields behind each wheel.
- Use Mopar® Touch Up Paint on scratches as soon as possible. An authorized dealer has touch up paint to match the color of your vehicle.

### Appearance Care For Fabric Top Models

To maintain the appearance of your vehicle's interior trim and top, follow these precautions:

- Do not run a fabric top through an automatic car wash. Window scratches and wax build-up may result.
- Avoid leaving your vehicle unattended with the top down, as exposure to sun or rain may damage interior trim.
- Do not use harsh cleaners or bleaching agents on top material, as damage may result.
- Do not allow any vinyl cleaner to run down and dry on the paint, leaving a streak.
- After cleaning your vehicle's fabric top, always make sure it is completely dry before lowering.
- Be especially careful when washing the windows by following the directions for "Care of Fabric Top Windows."

**Washing** – Use Mopar® Car Wash or equivalent, or mild soap suds, lukewarm water, and a brush with soft bristles. If extra cleaning is required, use Mopar® Convertible Cloth Top Cleaner or equivalent, or a mild foaming cleaner on the entire top, but support the top from underneath.

**Rinsing** – Be sure to remove all traces of cleaner by rinsing the top thoroughly with clean water. Remember to allow the top to dry before lowering it.

**CAUTION!**

Failure to follow these cautions may cause interior water damage, stains, or mildew of the top material:

- Do not run a fabric top through an automatic car wash. Window scratches and wax build-up may result.
- It is recommended that the top be free of water prior to opening it. Operating the top, opening a door or lowering a window while the top is wet may allow water to drip into the vehicle's interior.
- Use care when washing the vehicle, water pressure directed at the weather strip seals may cause water to leak into the vehicle's interior.
- Careless handling and storage of the removable roof panels may damage the seals, causing water to leak into the vehicle's interior.
- The front panel(s) must be positioned properly to ensure sealing. Improper installation can cause water to leak into the vehicle's interior.

**CAUTION!**

- Avoid washing with rollers and/or brushes in washing stations. Wash the vehicle only by hand using neutral pH detergents; dry it with a wet chamois leather. Abrasive products and/or polishes should not be used for cleaning the car. Bird droppings must be washed off immediately and thoroughly as the acid they contain is particularly aggressive.
- Avoid (if at all possible) parking the vehicle under trees; remove vegetable resins immediately as, when dried, it may only be possible to remove them with abrasive products and/or polishes, which is highly inadvisable as they could alter the typical opaqueness of the paint.
- Do not use pure windshield washer fluid for cleaning the front windshield and rear window; dilute it min. 50% with water. Only use pure windshield washer fluid when strictly necessary due to outside temperature conditions.

**Care Of Fabric Top Windows**

Your vehicle's fabric top has pliable plastic windows which can be scratched unless special care is taken by following these directions:

- Never use a dry cloth to remove dust. Instead, **use a microfiber towel or soft cotton cloth moistened with cold or warm, clean water, and wipe across the window, not up and down.** Mopar® Jeep® Soft Glass Window Cleaner or equivalent will safely clean all plastic windows without scratching. It removes fine scratches to improve visibility and provides UV protection to help prevent yellowing.
- When washing, **never use hot water** or anything stronger than a mild soap. Never use solvents such as alcohol or harsh cleaning agents.
- Always rinse thoroughly with cold water, then wipe with a soft and slightly moist, clean cloth.
- When removing frost, snow or ice, **never use a scraper or de-icing chemicals.** Use warm water only if you must clean the window quickly.
- Debris (sand, mud/dirt, dust, or salt) from off-road driving will have an impact on plastic retainer operation. Even normal on-road driving and vehicle washing will eventually impact window plastic retainer operation. To maintain ease of use of the window plastic retainers, each window plastic retainer should be cleaned and lubricated regularly. Clean them with a mild soap solution and a small brush. Cleaning products are available through an authorized dealer.
- Never paste stickers, gummed labels or any tape to the windows. Adhesives are hard to remove and may damage the windows.

## INTERIORS

### CARPET SAFETY INFORMATION

Always use carpet designed to fit your vehicle. Only use carpet that does not interfere with the operation of the pedal assemblies. Only operate the vehicle when the carpet is securely attached by the grommets so it cannot slip out of position and interfere with the pedal assemblies or impair safe operation of your vehicle in other ways.

#### WARNING!

- If operating the vehicle without carpet in place the floor may become hot, and there is a risk of burns.
- An improperly attached, damaged, folded, or damaged grommets may cause your carpet to interfere with the accelerator, brake, or clutch pedals and cause a loss of vehicle control. To prevent **SERIOUS INJURY** or **DEATH**: ALWAYS securely attach your carpet using the grommets.
- ALWAYS make sure objects cannot fall or slide into the driver's side floor area when the vehicle is moving. Objects can become trapped under accelerator, brake, or clutch pedals and could cause a loss of vehicle control.

(Continued)

#### WARNING!

- NEVER place any objects under the carpet (e.g., towels, keys, etc.). These objects could change the position of the carpet and may cause interference with the accelerator, brake, or clutch pedals.
- ONLY install carpet designed to fit your vehicle. NEVER install carpet that cannot be properly attached and secured to your vehicle. If the carpet needs to be replaced, only use manufacturer approved carpet for the specific make, model, and year of your vehicle.
- If the vehicle carpet has been removed and re-installed, always properly attach carpet to the floor and check that the floor mat fasteners are secure to the vehicle carpet. Fully depress each pedal to check for interference with the accelerator, brake, or clutch pedals then re-install the floor mats.

### CARPET REMOVAL

#### Front Carpets (Two And Four Door Models):

1. Remove the front grommets.

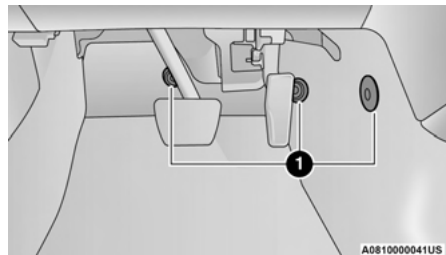

Front Carpet

1 — Grommets

2. Pull the carpet out from the front to the rear.

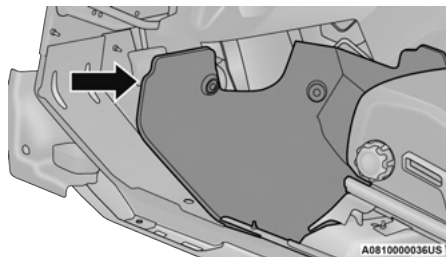

Front Carpet Pulled Away

3. Remove the grommets under the front seat.  
First for the rear carpet and then the front carpet.



**Front And Rear Carpet Split**

4. Under the back of the front seat, open the carpet split and then pull out the rear edge and slide the carpet to the front (do not remove the harness).

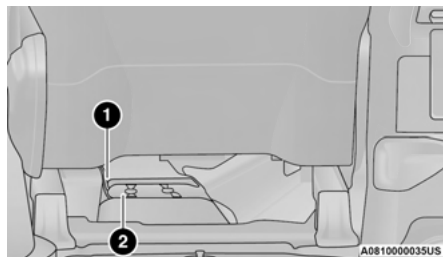

**Rear Underside Of Front Seat**

- 1 – Harness
- 2 – Carpet Split



**Front Seat And Floor**

- 1 – Grommets
- 2 – Carpet Split

5. Finally open the carpet split around seat bracket and then remove the last two grommets.

6. When reinstalling carpet please perform these steps in reverse order making sure that the carpet is tucked under the scuffs, B-pillar, console, and refasten grommets.

**Rear Carpet (Four Door Models):**

1. Remove the grommets under the front seat (one left and one right).
2. Then pull the carpet out, to the rear and open the carpet split around the front seats brackets.

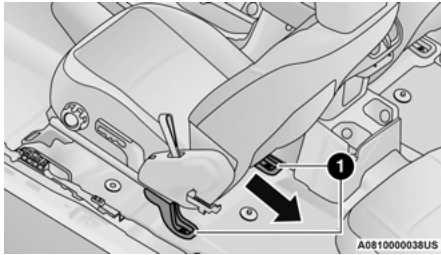
**Pull Toward The Rear Of Vehicle**

1 – Carpet Split

3. Remove the grommets under the rear seat (one left and one right). First the grommet for the cargo carpet and then the rear carpet.
4. Pull the carpet out to the front and open the carpet split around the rear seats brackets.

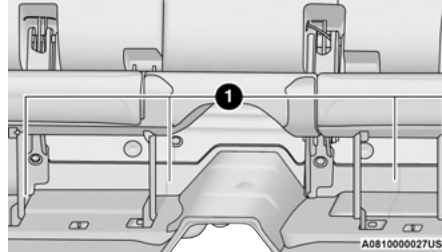
**Under Rear Seat**

1 – Carpet Split

**Rear Carpet (Two Door Models):**

1. Remove the rear seats.
2. Remove the side grommets (one left and one right). First the grommet from the side carpet and then the rear carpet.

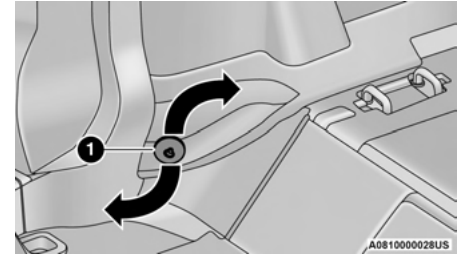
**Side Carpet**

1 – Grommet

5. When reinstalling carpet please perform these steps in reverse order making sure that the carpet is tucked under the scuffs, B-pillar, console, and refasten grommets.

3. Remove the grommets under the front seat (one left and one right).

- Then pull the carpet out to the rear and open the carpet split around the front seats brackets.

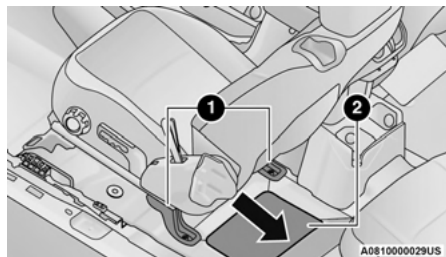

**Pull Carpet To The Rear**

- 1 – Carpet Split
- 2 – Rear Carpet

- When reinstalling carpet please perform these steps in reverse order making sure that the carpet is tucked under the scuffs, B-pillar, console, and refasten grommets.

**Cargo Carpet (Four Door Models):**

- Remove the grommets under the rear seat (one left and one right).
- Pull the carpet out to the rear and open the carpet split around the seat belt attachment.

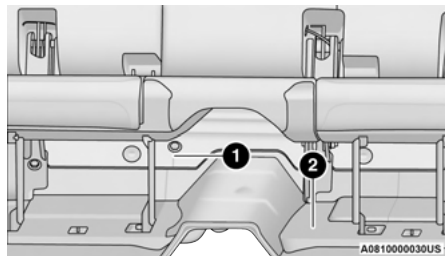

**Under Rear Seat**

- 1 – Carpet Split
- 2 – Rear Carpet

- Remove the carpet under the load floor and the side support and then pull the carpet out.

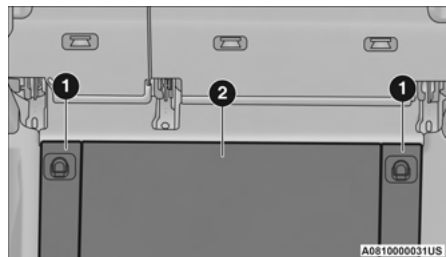

**Rear Load Floor**

- 1 – Side Supports
- 2 – Load Floor

- When reinstalling carpet please perform these steps in reverse order making sure that the carpet is tucked under the scuffs, B-pillar, console, and refasten grommets.



**Cargo Carpet (Four Door Models) With Gap Hider:**

1. Remove the grommets under the rear seat (one left and one right).
2. Pull the carpet out to the front and open the carpet split around the seat belt attachment and under the center seat bracket.

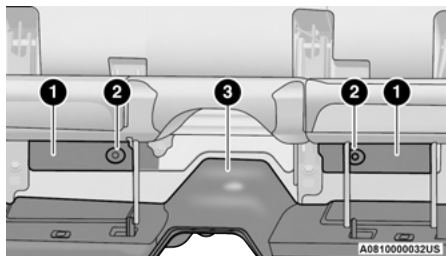
**Under Rear Seat**

- 1 – Carpet Split
- 2 – Grommets
- 3 – Rear Carpet

3. When reinstalling carpet please perform these steps in reverse order making sure that the carpet is tucked under the scuffs, B-pillar, console, and refasten grommets.

**Side Carpet (Four Door Models):**

1. Remove the side grommets (one left and one right).
2. Pull the carpet out starting on the top flange, then all around the perimeter and open the carpet split around the seat belt attachment.

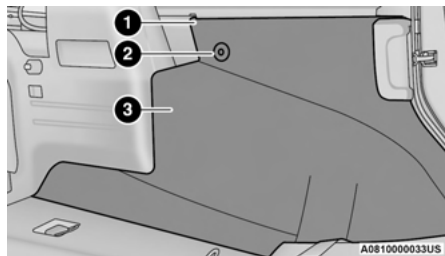
**Inside Sidewall**

- 1 – Top Flange
- 2 – Grommet
- 3 – Side Carpet

3. When reinstalling carpet please perform these steps in reverse order making sure that the carpet is tucked under the scuffs, B-pillar, console, and refasten grommets.

**Side Carpet (Two Door Models):**

1. Remove the side grommet and then the lower one (left and right).
2. Pull the carpet out starting on the top flange, then all around the perimeter and open the carpet split around the seat belt attachment.
3. When reinstalling carpet please perform these steps in reverse order making sure that the carpet is tucked under the scuffs, B-pillar, console, and refasten grommets.

**SEATS AND FABRIC PARTS**

Use Mopar® Total Clean to clean fabric upholstery and carpeting.

**WARNING!**

Do not use volatile solvents for cleaning purposes. Many are potentially flammable, and if used in closed areas they may cause respiratory harm.

**Seat Belt Maintenance**

Do not bleach, dye or clean the belts with chemical solvents or abrasive cleaners. This will weaken the fabric. Sun damage can also weaken the fabric.

If the belts need cleaning, use a mild soap solution or lukewarm water. Do not remove the belts from the vehicle to wash them. Dry with a soft cloth.

Replace the belts if they appear frayed or worn or if the buckles do not work properly.

**WARNING!**

A frayed or torn seat belt could rip apart in a collision and leave you with no protection. Inspect the seat belt system periodically, checking for cuts, frays, or loose parts. Damaged parts must be replaced immediately. Do not disassemble or modify the seat belt system. If your vehicle is involved in a collision, or if you have questions regarding seat belt or retractor conditions, take your vehicle to an authorized FCA dealer or authorized FCA Certified Collision Care Program facility for inspection.

**PLASTIC AND COATED PARTS**

Use Mopar® Total Clean to clean vinyl upholstery.

**CAUTION!**

- Direct contact of air fresheners, insect repellents, suntan lotions, or hand sanitizers to the plastic, painted, or decorated surfaces of the interior may cause permanent damage. Wipe away immediately.

*(Continued)*

**CAUTION!**

- Damage caused by these type of products may not be covered by your New Vehicle Limited Warranty.

**Cleaning Plastic Instrument Cluster Lenses**

The lenses in front of the instruments in this vehicle are molded in clear plastic. When cleaning the lenses, care must be taken to avoid scratching the plastic.

Clean with a wet soft cloth. A mild soap solution may be used, but do not use high alcohol content or abrasive cleaners. If soap is used, wipe clean with a clean damp cloth. Dry with a soft cloth.

**LEATHER SURFACES**

Mopar® Total Clean is specifically recommended for leather upholstery.

Your leather upholstery can be best preserved by regular cleaning with a damp soft cloth. Small particles of dirt can act as an abrasive and damage the leather upholstery and should be removed promptly with a damp cloth. Stubborn soils can be removed easily with a soft cloth and Mopar® Total Clean. Care should be taken to avoid soaking your leather upholstery with any liquid. Please do not use polishes, oils, cleaning fluids, solvents,

detergents, or ammonia-based cleaners to clean your leather upholstery.

**NOTE:**

If equipped with light colored leather, it tends to show any foreign material, dirt, and fabric dye transfer more so than darker colors. The leather is designed for easy cleaning, and FCA recommends Mopar® total care leather cleaner applied on a cloth to clean the leather seats as needed.

**CAUTION!**

Do not use Alcohol and Alcohol-based and/or Ketone based cleaning products to clean leather upholstery, as damage to the upholstery may result.

**GLASS SURFACES**

All glass surfaces should be cleaned on a regular basis with Mopar® Glass Cleaner, or any commercial household-type glass cleaner. Never use an abrasive type cleaner. Use caution when cleaning the inside rear window equipped with electric defrosters or windows equipped with radio antennas. Do not use scrapers or other sharp instruments that may scratch the elements.

When cleaning the rear view mirror, spray cleaner on the towel or cloth that you are using. Do not spray cleaner directly on the mirror.

# TECHNICAL SPECIFICATIONS

## VEHICLE IDENTIFICATION NUMBER (VIN)

The VIN is found on the left front corner of the A-pillar, visible from outside of the vehicle through the windshield.

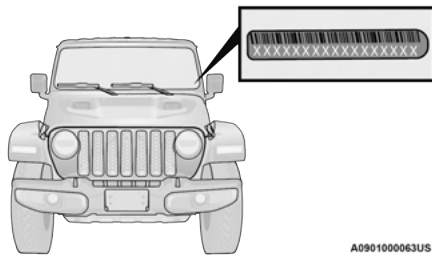

Vehicle Identification Number

### NOTE:

It is illegal to remove or alter the VIN plate.

## BRAKE SYSTEM

Your vehicle is equipped with dual hydraulic brake systems. If either of the two hydraulic systems lose normal capability, the remaining system will still function. However, there will be some loss of overall braking effectiveness. You may notice

increased pedal travel during application, greater pedal force required to slow or stop, and potential activation of the Brake Warning Light.

In the event power assist is lost for any reason (i.e., repeated brake applications with the engine off) the brakes will still function. However, the effort required to brake the vehicle will be much greater than that required with the power system operating.

## WHEEL AND TIRE TORQUE SPECIFICATIONS

Proper lug nut/bolt torque is very important to ensure that the wheel is properly mounted to the vehicle. Any time a wheel has been removed and reinstalled on the vehicle, the lug nuts/bolts should be torqued using a properly calibrated torque wrench using a six-sided (hex) deep wall socket.

### TORQUE SPECIFICATIONS

Lug Nut/Bolt Torque	**Lug Nut/Bolt Size	Lug Nut/Bolt Socket Size
130 Ft-Lb (176 N·m)	M14 x 1.50	22 mm

\*\*Use only authorized dealer recommended lug nuts/bolts and clean or remove any dirt or oil before tightening.

Inspect the wheel mounting surface prior to mounting the tire and remove any corrosion or loose particles.

### Spare Tire Torque Specifications

Lug Nut/Bolt Torque	**Lug Nut/Bolt Size	Lug Nut/Bolt Socket Size
59 Ft-Lb (80 N·m)	M14 x 1.50	22 mm

\*\*Use only authorized dealer recommended lug nuts/bolts and clean or remove any dirt or oil before tightening.

Spare tire torque is for the spare tire carrier located on the swing gate.

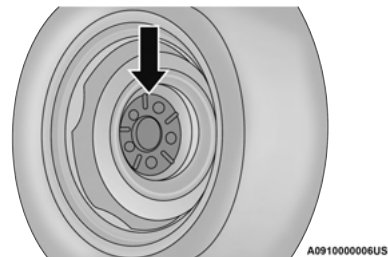

Wheel Mounting Surface

Tighten the lug nuts/bolts in a star pattern until each nut/bolt has been tightened twice. Ensure that the socket is fully engaged on the lug nut/bolt (do not insert it halfway).

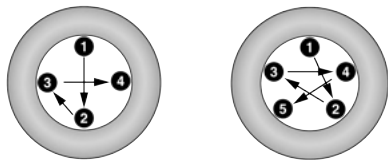

Torque Patterns

A0910000005US

After 25 miles (40 km), check the lug nut/bolt torque to be sure that all the lug nuts/bolts are properly seated against the wheel.

#### WARNING!

To avoid the risk of forcing the vehicle off the jack, do not tighten the lug nuts/bolts fully until the vehicle has been lowered. Failure to follow this warning may result in personal injury.

## FUEL REQUIREMENTS — GASOLINE ENGINE

While operating on gasoline with the required octane number, hearing a light knocking sound from the engine is not a cause for concern. However, if the engine is heard making a heavy knocking sound, see a dealer immediately. Use of gasoline with an octane number lower than recommended octane can cause engine failure and may void the New Vehicle Limited Warranty.

Poor quality gasoline can cause problems such as hard starting, stalling, and hesitations. If you experience these symptoms, try another brand of gasoline before considering service for the vehicle.

### 2.0L ENGINE



This engine is designed to meet all emissions requirements, and provide satisfactory fuel economy and performance, when using high-quality unleaded regular gasoline having an octane rating of 87, as specified by the (R+M)/2 method. The use of 91 or higher octane premium gasoline will allow these engines to operate to optimal performance. This increase in performance is most noticeable in hot weather or other heavier load conditions, such as while towing.

### 3.6L ENGINE



This engine is designed to meet all emissions regulations and provide satisfactory fuel economy and performance when using high-quality unleaded regular gasoline having an octane rating of 87 as specified by the (R+M)/2 method. The use of higher octane premium gasoline will not provide any benefit over regular gasoline in these engines.

### REFORMULATED GASOLINE

Many areas of the country require the use of cleaner burning gasoline referred to as “reformulated gasoline”. Reformulated gasoline contains oxygenates and are specifically blended to reduce vehicle emissions and improve air quality.

The use of reformulated gasoline is recommended. Properly blended reformulated gasoline will provide improved performance and durability of engine and fuel system components.

### MATERIALS ADDED TO FUEL

Besides using unleaded gasoline with the proper octane rating, gasolines that contain detergents, corrosion and stability additives are recommended. Using gasolines that have these additives will help improve fuel economy, reduce emissions, and maintain vehicle performance.



Designated TOP TIER Detergent Gasoline contains a higher level of detergents to further aide in minimizing engine and fuel system deposits. When available, the usage of TOP TIER Detergent gasoline is recommended. Visit [www.toptiergas.com](http://www.toptiergas.com) for a list of TOP TIER Detergent Gasoline Retailers.

Indiscriminate use of fuel system cleaning agents should be avoided. Many of these materials intended for gum and varnish removal may contain active solvents or similar ingredients. These can harm fuel system gasket and diaphragm materials.

## GASOLINE/OXYGENATE BLENDS

Some fuel suppliers blend unleaded gasoline with oxygenates such as ethanol.

### CAUTION!

DO NOT use E-85, gasoline containing methanol, or gasoline containing more than 15% ethanol (E-15). Use of these blends may result in starting and drivability problems, damage critical fuel system components, cause emissions to exceed the applicable standard, and/or cause the Malfunction Indicator Light to illuminate. Please observe pump labels as they should clearly communicate if a fuel contains greater than 15% ethanol (E-15).

Problems that result from using gasoline containing more than 15% ethanol (E-15) or gasoline containing methanol are not the responsibility of the manufacturer and may void or not be covered under New Vehicle Limited Warranty.

## DO NOT USE E-85 IN NON-FLEX FUEL VEHICLES

Non-Flex Fuel Vehicles (FFV) are compatible with gasoline containing up to 15% ethanol (E-15). Use of gasoline with higher ethanol content may void the New Vehicle Limited Warranty.

If a Non-FFV vehicle is inadvertently fueled with E-85 fuel, the engine will have some or all of these symptoms:

- Operate in a lean mode
- OBD II Malfunction Indicator Light on
- Poor engine performance
- Poor cold start and cold drivability
- Increased risk for fuel system component corrosion

## CNG AND LP FUEL SYSTEM MODIFICATIONS

Modifications that allow the engine to run on Compressed Natural Gas (CNG) or Liquid Propane (LP) may result in damage to the engine, emissions, and fuel system components. Problems that result from running CNG or LP are not the responsibility of the manufacturer and may void or not be covered under the New Vehicle Limited Warranty.

## MMT IN GASOLINE

Methylcyclopentadienyl Manganese Tricarbonyl (MMT) is a manganese-containing metallic additive that is blended into some gasoline to increase octane. Gasoline blended with MMT provides no performance advantage beyond gasoline of the same octane number without MMT. Gasoline blended with MMT reduces spark plug life and reduces emissions system performance in some vehicles. The manufacturer recommends that gasoline without MMT be used in your vehicle. The MMT content of gasoline may not be indicated on the gasoline pump; therefore, you should ask your gasoline retailer whether the gasoline contains MMT. MMT is prohibited in Federal and California reformulated gasoline.

**FUEL SYSTEM CAUTIONS****CAUTION!**

Follow these guidelines to maintain your vehicle's performance:

- The use of leaded gasoline is prohibited by Federal law. Using leaded gasoline can impair engine performance and damage the emissions control system.
- An out-of-tune engine or certain fuel or ignition malfunctions can cause the catalytic converter to overheat. If you notice a pungent burning odor or some light smoke, your engine may be out of tune or malfunctioning and may require immediate service. Contact an authorized dealer for service assistance.
- The use of fuel additives, which are now being sold as octane enhancers, is not recommended. Most of these products contain high concentrations of methanol. Fuel system damage or vehicle performance problems resulting from the use of such fuels or additives is not the responsibility of the manufacturer and may void or not be covered under the New Vehicle Limited Warranty.

**NOTE:**

Intentional tampering with the emissions control system can result in civil penalties being assessed against you.

**FUEL REQUIREMENTS – DIESEL ENGINE**

Federal law requires that you must fuel this vehicle with Ultra Low Sulfur Highway Diesel fuel (15 ppm Sulfur maximum) and prohibits the use of Low Sulfur Highway Diesel fuel (500 ppm Sulfur maximum) to avoid damage to the emissions control system.

Use good quality diesel fuel from a reputable supplier in your vehicle. For most year-round service, No. 2 diesel fuel meeting ASTM (formerly known as the American Society for Testing and Materials) specification D-975 Grade S15 will provide good performance. If the vehicle is exposed to extreme cold (below 20°F or -7°C), or is required to operate at colder-than-normal conditions for prolonged periods, use climatized No. 2 diesel fuel or dilute the No. 2 diesel fuel with 50% No. 1 diesel fuel. This will provide better protection from fuel gelling or wax-plugging of the fuel filters.

**WARNING!**

Do not use alcohol or gasoline as a fuel blending agent. They can be unstable under certain conditions and hazardous or explosive when mixed with diesel fuel.

Diesel fuel is seldom completely free of water. To prevent fuel system trouble, drain the accumulated water from the fuel/water separator using the fuel/water separator drain provided on the fuel filter housing. If you buy good quality fuel and follow the cold weather advice above, fuel conditioners should not be required in your vehicle. If available in your area, a high cetane "premium" diesel fuel may offer improved cold-starting and warm-up performance.

**CAUTION!**

If the Water in Fuel Indicator Light remains on, **DO NOT START** engine before you drain the water from the fuel filter(s) to avoid engine damage  
 ⇨ page 362.

## DIESEL FUEL SPECIFICATIONS

This diesel engine has been developed to take advantage of the high energy content and generally lower cost No. 2 Ultra Low Sulfur diesel fuel or No. 2 Ultra Low Sulfur climatized diesel fuels.

### NOTE:

- If you accidentally fill the fuel tank with gasoline on your diesel vehicle, do not start the engine. Damage to the engine and fuel system could occur. Please call an authorized dealer for service.
- A maximum blend of 5% biodiesel meeting ASTM specification D-975 may be used with your diesel engine without any adjustments to regular service schedules.
- Commercially available fuel additives are not necessary for the proper operation of your diesel engine.
- No. 1 Ultra Low Sulfur diesel fuel should only be used where extended arctic conditions (-10 °F or -23 °C) exist.

## BIODIESEL FUEL REQUIREMENTS

A maximum blend of 5% biodiesel meeting ASTM specification D975 is recommended for use with your diesel engine. If frequent operation with Biodiesel blends that are between 6% and 20%

(B6–B20) is desired, the maintenance schedule is subject to shorter intervals.

The oil and filter change along with fuel filter replacement is subject to shorter intervals when operating your engine on biodiesel greater than 5%. Do not use biodiesel greater than 20%.

For regular use of biodiesel blends between 6% and 20% (B6–B20) it is important that you understand and comply with these requirements  page 352.

<b>CAUTION!</b>
Failure to comply with Oil Change requirements for vehicles operating on biodiesel blends between 6% and 20% (B6–B20) will result in premature engine wear. Such wear is not covered by the New Vehicle Limited Warranty.

Biodiesel is a fuel produced from renewable resources typically derived from animal fat, rapeseed oil (Rapeseed Methyl Ester (RME) base), or soybean oil (Soy Methyl Ester (SME or SOME) base).

Biodiesel fuel has inherent limitations which require that you understand and adhere to the following requirements if you use blends of Biodiesel between 6% and 20% (B6–B20). There are no unique restrictions for the use of B5.

<b>CAUTION!</b>
Use of blends greater than 20% is not approved. Use of blends greater than 20% can result in engine damage. Such damage is not covered by the New Vehicle Limited Warranty.

<b>CAUTION!</b>
In the event that the vehicle is filled with biodiesel and not used for more than a month, the fuel should either be used up by driving (up to quarter tank) and filled with standard diesel blends with less than 5% that is normally available. This will help prevent the fuel filter clogging and potential damage to the fuel injection system due to degraded biodiesel, which is not covered by the New Vehicle Limited Warranty.

## Biodiesel Fuel Properties – Low Ambient Temperatures

Biodiesel fuel may gel or solidify at low ambient temperatures, which may pose problems for both storage and operation. Precautions can be necessary at low ambient temperatures, such as storing the fuel in a heated building or a heated storage tank, or using cold temperature additives.

### **Fuel Quality — Must Comply With ASTM Standards**

The quality of Biodiesel fuel may vary widely. Only fuel produced by a BQ9000 supplier to the following specifications may be blended to meet Biodiesel blend B6 – B20 fuel meeting ASTM specification D-7467:

- Petrodiesel fuel meeting ASTM specification D-975 and Biodiesel fuel (B100) meeting ASTM specification D-6751

### **Fuel Oxidation Stability — Must Use Fuel Within Six Months Of Manufacture**

Biodiesel fuel has poor oxidation stability which can result in long term storage problems. Fuel produced to approved ASTM standards, if stored properly, provides for protection against fuel oxidation for up to six months.

### **Fuel Water Separation — Must Use Mopar® Approved Fuel Filter Elements**

Biodiesel fuel has a natural affinity to water and water accelerates microbial growth. Your Mopar® filtration system is designed to provide adequate fuel water separation capabilities.

### **Fuel In Oil Dilution — Must Adhere To Required Oil Change Interval**

Fuel dilution of lubricating oil has been observed with the use of Biodiesel fuel. Fuel in oil must not exceed 5%. To ensure this limit is met your oil change interval must be maintained with in the suggested schedule. The regular use of biodiesel between 6% and 20% requires intervals shorter than the outlined 10,000 miles (16,000 km) and must not exceed the suggested schedule. When routinely operating on biodiesel between 6% and 20%, oil and filter replacement intervals must not exceed 8,000 Miles (12,875 km) or six months, which ever comes first.

### **Biodiesel Fuel Filter Change Intervals**

The use of biodiesel requires more frequent fuel filter change intervals. When operating on biodiesel between 6% and 20%, fuel filter replacement intervals should be every second oil change, and must not exceed 16,000 miles (25,750 km).

#### **NOTE:**

Under no circumstances should oil change intervals exceed 8,000 miles (12,875 km) or 6 months, if regular operation occurs with 6% - 20% biodiesel blends. Under no circumstances should fuel filter replacement intervals exceed every second oil change and must not exceed 16,000 miles (25,750 km), if regular operation occurs with 6% - 20% biodiesel blends. Failure to comply with these Oil Change and fuel filter requirements for vehicles operating on biodiesel blends up to B20 may result in premature engine wear. Such wear is not covered by the New Vehicle Limited Warranty. The engine may suffer severe damage if operated with concentrations of biodiesel higher than 20%.



## FLUID CAPACITIES

	US	Metric
<b>Fuel (Approximate)</b>		
Two Door Models	17.5 Gallons	66 Liters
Four Door Models	21.5 Gallons	81 Liters
3.0L Diesel Engine	18.3 Gallons	69 Liters
Diesel Exhaust Fluid Tank	5.1 Gallons	19.3 Liters
<b>Engine Oil with Filter</b>		
2.0L Engine	5 Quarts	4.73 Liters
3.6L Engine	5 Quarts	4.73 Liters
3.0L Diesel Engine	9 Quarts	8.5 Liters
<b>Cooling System *</b>		
2.0L Engine	12 Quarts	11.4 Liters
2.0L Engine Intercooler	3.7 Quarts	3.5 Liters
3.6L Engine	13.4 Quarts	12.7 Liters
3.6L Motor Generator Unit (MGU)	2.2 Quarts	2.1 Liters
3.6L Power Pack Unit (PPU) Coolant	3.3 Quarts	3.1 Liters
3.0L Diesel Engine	14.8 Quarts	14 Liters

\* Includes coolant recovery bottle filled to MAX level.

## ENGINE FLUIDS AND LUBRICANTS

### GASOLINE ENGINES

Component	Fluid, Lubricant, or Genuine Part
Engine Coolant	We recommend using Mopar® Antifreeze/Coolant 10 Year/150,000 Mile (240,000 km) Formula OAT (Organic Additive Technology) or equivalent meeting the requirements of the manufacturer Material Standard MS.90032.
Intercooler	We recommend using Mopar® Antifreeze/Coolant 10 Year/150,000 Mile (240,000 km) Formula OAT (Organic Additive Technology) or equivalent meeting the requirements of the manufacturer Material Standard MS.90032.
Engine Oil – 2.0L Engine	We recommend using Mopar® API SP/GF-6A Certified SAE 5W-30 Full Synthetic Engine Oil which meets the requirements of the manufacturer Material Standard MS-13340. Equivalent full synthetic 5W-30 API SP engine oil can be used but must have the API Donut trademark ↗ page 360.
	<p style="text-align: center;"><b>CAUTION!</b></p> <p><b>Failure to use the recommended API SP/GF-6A or equivalent oil can cause engine damage not covered by the vehicle warranty.</b></p>
Engine Oil – 3.6L Engine	We recommend using Mopar® SAE 0W-20 Full Synthetic Engine Oil which meets the requirements of the manufacturer Material Standard MS-6395. Equivalent full synthetic SAE 0W-20 engine oil can be used but must have the API Starburst trademark ↗ page 360.
Engine Oil Filter	We recommend using a Mopar® Engine Oil Filter. If a Mopar® Engine Oil Filter is unavailable only use filters that meet or exceed SAE/USCAR-36 Filter Performance Requirements.
Fuel Selection – 2.0L Engine	87 Octane (R+M)/2 Method, 0-15% Ethanol.
Fuel Selection – 3.6L Engine	87 Octane (R+M)/2 Method, 0-15% Ethanol.

**CAUTION!**

- Mixing of engine coolant (antifreeze) other than specified Organic Additive Technology (OAT) engine coolant (antifreeze), may result in engine damage and may decrease corrosion protection. Organic Additive Technology (OAT) engine coolant is different and should not be mixed with Hybrid Organic Additive Technology (HOAT) engine coolant (antifreeze) or any “globally compatible” coolant (antifreeze). If a non-OAT engine coolant (antifreeze) is introduced into the cooling system in an emergency, the cooling system will need to be drained, flushed, and refilled with fresh OAT coolant (conforming to MS.90032), by an authorized dealer as soon as possible.
- Do not use water alone or alcohol-based engine coolant (antifreeze) products. Do not use additional rust inhibitors or antirust products, as they may not be compatible with the radiator engine coolant and may plug the radiator.
- This vehicle has not been designed for use with propylene glycol-based engine coolant (antifreeze). Use of propylene glycol-based engine coolant (antifreeze) is not recommended.

**DIESEL ENGINES**

Component	Fluid, Lubricant, or Genuine Part
Engine Coolant	We recommend using Mopar® Antifreeze/Coolant 10 Year/150,000 Mile (240,000 km) Formula OAT (Organic Additive Technology) or equivalent meeting the requirements of the manufacturer Material Standard MS.90032.
Engine Oil – 3.0L Diesel Engine	We recommend using Mopar® API Certified SAE 5W-40 Full Synthetic Engine Oil which meets the requirements of the manufacturer Material Standard MS-12991. Equivalent full synthetic SAE 5W-40 engine oil can be used but must have the API Donut trademark ↗ page 360.
Engine Oil Filter	We recommend using a Mopar® Engine Oil Filter. If a Mopar® Engine Oil Filter is unavailable only use filters that meet or exceed SAE/USCAR-36 Filter Performance Requirements.
Fuel Filters – 3.0L Diesel Engine	We recommend using Mopar® Fuel Filter. Must meet 3 micron rating. <b>Using a fuel filter that does not meet the manufacturer filtration and water separating requirements can severely impact fuel system life and reliability.</b>

Component	Fluid, Lubricant, or Genuine Part
Fuel Selection — 3.0L Diesel Engine	<p>Use good quality diesel fuel from a reputable supplier in your vehicle. Federal law requires that you must fuel this vehicle with Ultra Low Sulfur Highway Diesel fuel (15 ppm Sulfur maximum) and prohibits the use of Low Sulfur Highway Diesel fuel (500 ppm Sulfur maximum) to avoid damage to the emissions control system. For most year-round service, Number 2 diesel fuel meeting ASTM specification D-975 Grade S15 will provide good performance. We recommend you use a blend of up to 5% biodiesel, meeting ASTM specification D-975 with your diesel engine.</p> <p><b>This vehicle is compatible with biodiesel blends greater than 5% but no greater than 20% biodiesel meeting ASTM specification D-7467 provided the shortened maintenance intervals are followed as directed.</b></p>
Diesel Exhaust Fluid — 3.0L Diesel Engine	Mopar® Diesel Exhaust Fluid (DEF) (API Certified) or equivalent that has been API Certified to the ISO 22241 standard. Use of fluids not API Certified to ISO 22241 may result in system damage.

## CHASSIS FLUIDS AND LUBRICANTS

Component	Fluid, Lubricant, or Genuine Part
Automatic Transmission – If Equipped	Use only Mopar® ZF 8 & 9 Speed Automatic Transmission Fluid (ATF) or equivalent. Failure to use the correct fluid may affect the function or performance of your transmission.
Manual Transmission – If Equipped	We recommend using Mopar® ATF+4 Automatic Transmission Fluid.
Transfer Case	We recommend using Mopar® ATF+4 Automatic Transmission Fluid.
Front Axle Differential	We recommend using Mopar® Gear & Axle Lubricant (SAE 75W85) (API GL-5).

<b>Component</b>	<b>Fluid, Lubricant, or Genuine Part</b>
Rear Axle Differential (M200 Sales Code DRZ)	We recommend using Mopar® Gear & Axle Lubricant (SAE 75W140) (API GL-5).
Rear Axle Differential (M220 Sales Codes DRE/DRF)	We recommend using Mopar® Gear & Axle Lubricant (SAE 75W85) (API GL-5). Models equipped with Trac-Lok Limited Slip Differential require a friction modifier additive.
Brake Master Cylinder	We recommend using Mopar® DOT 3 Brake Fluid, SAE J1709.
Power Steering Reservoir	We recommend using Mopar® Electric Steering Pump Fluid.

# CUSTOMER ASSISTANCE

## SUGGESTIONS FOR OBTAINING SERVICE FOR YOUR VEHICLE

### PREPARE FOR THE APPOINTMENT

All work to be performed may not be covered by the warranty. Discuss additional charges with the service manager. Keep a maintenance log of your vehicle's service history. This can often provide a clue to the current problem.

### PREPARE A LIST

Make a written list of your vehicle's problems or the specific work you want done. If you've had an accident or work done that is not on your maintenance log, let the service advisor know.

### BE REASONABLE WITH REQUESTS

If you list a number of items and you must have your vehicle by the end of the day, discuss the situation with the service advisor and list the items in order of priority. At many authorized dealers, you may obtain a rental vehicle (additional charges may apply). If you need a rental, it is advisable to make these arrangements when you call for an appointment.

## IF YOU NEED ASSISTANCE

FCA US LLC and its authorized dealers are vitally interested in your satisfaction. We want you to be happy with our products and services.

Warranty service must be done by an authorized dealer. We strongly recommend that you take the vehicle to an authorized dealer. They know your vehicle the best, and are most concerned that you get prompt and high quality service. FCA US LLC's authorized dealers have the facilities, factory-trained technicians, special tools, and the latest information to ensure the vehicle is fixed correctly and in a timely manner.

This is why you should always talk to an authorized dealer's service manager first. If for some reason you are still not satisfied, talk to the general manager or owner of the authorized dealer. They want to know if you need assistance. If an authorized dealer is unable to resolve the concern, you may contact FCA US LLC's Customer Assistance center.

Any communication to FCA US LLC's customer center should include the following information:

- Owner's name and address
- Owner's telephone number (mobile, home and office)

- Authorized dealer name
- Vehicle Identification Number (VIN)
- Vehicle delivery date and mileage

### FCA US LLC CUSTOMER CENTER

P.O. Box 21-8004

Auburn Hills, MI 48321-8004

Phone: (877) 426-5337

### FCA CANADA INC. CUSTOMER CENTER

P.O. Box 1621

Windsor, Ontario N9A 4H6

Phone: (800) 465-2001 English /  
(800) 387-9983 French

### MEXICO

Av. Prolongacion Paseo de la Reforma, 1240

Sante Fe C.P. 05109

Mexico, D.F.

In Mexico City: (800) 505-1300

Outside Mexico City: +(52) 55 50817568

## PUERTO RICO AND US VIRGIN ISLANDS

FCA Caribbean LLC  
 P.O. Box 191857  
 San Juan 00919-1857  
 Phone: (877) 426-5337  
 Fax: (787) 782-3345

### CUSTOMER ASSISTANCE FOR THE HEARING OR SPEECH IMPAIRED (TDD/TTY)

To assist customers who have hearing difficulties, FCA US LLC has installed special Telecommunication Devices for the Deaf (TDD) equipment at its customer center. Any hearing or speech impaired customer, who has access to a TDD or a conventional teletypewriter (TTY) in the United States, can communicate with the manufacturer by dialing 1-800-380-2479.

Canadian residents with hearing difficulties that require assistance can use the special needs relay service offered by Bell Canada. For TTY teletypewriter users, dial 711 and for Voice callers, dial 1-800-855-0511 to connect with a Bell Relay Service operator.

## SERVICE CONTRACT

You may have purchased a service contract for a vehicle to help protect you from the high cost of unexpected repairs after FCA US LLC's New Vehicle Limited Warranty expires. The Mopar® Vehicle Protection plans are the ONLY vehicle extended protection plans authorized, endorsed and backed by FCA US LLC to provide additional protection beyond your vehicle's warranty. If you purchased a Mopar® Vehicle Protection Plan, you will receive Plan Provisions and an Owner Identification Card in the mail within three weeks of the vehicle delivery date. If you have any questions about the service contract, call the manufacturer's Service Contract National Customer Hotline at 1-800-521-9922 (Canadian residents, call (800) 465-2001 English / (800) 387-9983 French).

FCA US LLC is not responsible for any service contract you may have purchased from another manufacturer. If you require service after FCA US LLC's New Vehicle Limited Warranty expires, please refer to the contract documents, and contact the person listed in those documents.

We appreciate that you have made a major investment when you purchased the vehicle. An authorized dealer has also made a major investment in facilities, tools, and training to assure that you are absolutely delighted with the ownership experience.

### WARNING!

Engine exhaust (internal combustion engines only), some of its constituents, and certain vehicle components contain, or emit, chemicals known to the State of California to cause cancer and birth defects, or other reproductive harm. In addition, certain fluids contained in vehicles and certain products of component wear contain, or emit, chemicals known to the State of California to cause cancer and birth defects, or other reproductive harm.

## WARRANTY INFORMATION

See the Warranty Information for the terms and provisions of FCA US LLC warranties applicable to this vehicle and market. Refer to [www.mopar.com](http://www.mopar.com) for further information.

See the Warranty Information for the terms and provisions of FCA Canada Inc. warranties applicable to this vehicle and market.

Use this QR code to access your digital experience.



## MOPAR® PARTS

Mopar® original equipment parts & accessories and factory filled fluids are available from an authorized dealer. They are recommended for your vehicle to keep it operating at its best and maintain its original condition.

## REPORTING SAFETY DEFECTS

### IN THE 50 UNITED STATES AND WASHINGTON, D.C.

If you believe that your vehicle has a defect that could cause a crash or cause injury or death, you should immediately inform the National Highway Traffic Safety Administration (NHTSA) in addition to notifying FCA US LLC.

If NHTSA receives similar complaints, it may open an investigation, and if it finds that a safety defect exists in a group of vehicles, it may order a recall and remedy campaign. However, NHTSA cannot become involved in individual problems between you, an authorized dealer, or FCA US LLC.

To contact NHTSA, you may call the Vehicle Safety Hotline toll free at 1-888-327-4236 (TTY: 1-800-424-9153); or go to <http://www.safercar.gov>; or write to: Administrator, NHTSA, 1200 New Jersey Avenue, SE., West Building, Washington, D.C. 20590. You can also obtain other information about motor vehicle safety from <http://www.safercar.gov>.

### IN CANADA

If you believe that your vehicle has a safety defect, you should contact the Customer Service Department immediately. Canadian customers who wish to report a safety defect to the Canadian government should contact Transport Canada, Motor Vehicle Defect Investigations and Recalls at 1-800-333-0510 or go to [www.apps.tc.gc.ca/Saf-Sec-Sur/7/PCDB-BDPP](http://www.apps.tc.gc.ca/Saf-Sec-Sur/7/PCDB-BDPP).

## PUBLICATION ORDER FORMS

To order the following manuals, you may use either the website or the phone numbers listed below.

### Service Manuals

These comprehensive Service Manuals provide a complete working knowledge of the vehicle, system, and/or components and is written in straightforward language with illustrations, diagrams, and charts.

### Diagnostic Procedure Manuals

Diagnostic Procedure Manuals are filled with diagrams, charts and detailed illustrations. These manuals make it easy to find and fix problems on computer-controlled vehicle systems and features. They show exactly how to find and correct problems, using step-by-step troubleshooting and drivability procedures, proven diagnostic tests and a complete list of all tools and equipment.

To order a hard copy of your Service or Diagnostic Procedure manuals, visit:

[www.techauthority.com](http://www.techauthority.com) (US and Canada).



## Owner's Manuals

These Owner's Manuals have been prepared with the assistance of service and engineering specialists to acquaint you with specific FCA vehicles.

To access your Owner's Information online, visit [www.mopar.com/om](http://www.mopar.com/om) (US) or [www.owners.mopar.ca](http://www.owners.mopar.ca) (Canada).

Or

Call Tech Authority toll free at:

- **1-800-890-4038 (US)**

Owner's Manuals, Radio Manuals and Warranty Information Books can be ordered through Archway at:

- **1-800-387-1143 (Canada)**

## GENERAL INFORMATION

The following regulatory statement applies to all Radio Frequency (RF) devices equipped in this vehicle:

This device complies with Part 15 of the FCC Rules and with Innovation, Science and Economic Development Canada license-exempt RSS standard(s). Operation is subject to the following two conditions:

1. This device may not cause harmful interference, and
2. This device must accept any interference received, including interference that may cause undesired operation.

Le présent appareil est conforme aux CNR d'Innovation, Science and Economic Development applicables aux appareils radio exempts de licence. L'exploitation est autorisée aux deux conditions suivantes:

1. l'appareil ne doit pas produire de brouillage, et
2. l'utilisateur de l'appareil doit accepter tout brouillage radioélectrique subi, même si le brouillage est susceptible d'en compromettre le fonctionnement.



La operación de este equipo está sujeta a las siguientes dos condiciones:

1. es posible que este equipo o dispositivo no cause interferencia perjudicial y
2. este equipo o dispositivo debe aceptar cualquier interferencia, incluyendo la que pueda causar su operación no deseada.

### NOTE:



Changes or modifications not expressly approved by the party responsible for compliance could void the user's authority to operate the equipment.

# INDEX

- A**
- About Your Brakes ..... 417
  - Adaptive Cruise Control (ACC) (Cruise Control)..... 169, 171
  - Adding Engine Coolant (Antifreeze) ..... 372
  - Adding Fuel..... 186, 187
  - Additives, Fuel ..... 418
  - Advance Phone Connectivity ..... 248
  - Air Bag
    - Air Bag Operation ..... 304
    - Air Bag Warning Light ..... 302, 305
    - Enhanced Accident Response ..... 313, 346
    - Event Data Recorder (EDR) ..... 346
    - Front Air Bag ..... 303, 305
    - If Deployment Occurs ..... 312
    - Knee Impact Bolsters ..... 310
    - Maintaining Your Air Bag System ..... 313
    - Maintenance ..... 313
    - Redundant Air Bag Warning Light ..... 303
    - Transporting Pets ..... 327
  - Air Bag Light ..... 128, 302, 327
  - Air Cleaner, Engine (Engine Air Cleaner Filter) ..... 360
  - Air Conditioner Maintenance ..... 366
  - Air Conditioner Refrigerant ..... 366, 367
  - Air Conditioner System ..... 366
  - Air Conditioning Filter..... 68, 367
  - Air Conditioning System ..... 67
  - Air Conditioning, Operating Tips..... 68
  - Air Filter ..... 360
  - Air Pressure
    - Tires ..... 398
  - Alarm
    - Arm The System ..... 24
    - Disarm The System ..... 24
    - Security Alarm ..... 24, 131
  - Alterations/Modifications
    - Vehicle..... 11
  - Android Auto ..... 250, 251
  - Android Auto™  ..... 250
  - Antifreeze (Engine Coolant) ..... 372, 423
    - Disposal ..... 373
  - Anti-Lock Brake System (ABS) ..... 275
  - Anti-Lock Warning Light ..... 131
  - Apple CarPlay..... 250, 253
  - Apple CarPlay®  ..... 252
  - Assist, Hill Start..... 280
  - Audio Settings..... 234
  - Audio Systems (Radio)..... 207
  - Auto Down Power Windows ..... 75
  - Automatic Dimming Mirror..... 51
  - Automatic Door Locks..... 28
  - Automatic Headlights..... 58
  - Automatic High Beams..... 58
  - Automatic Temperature Control (ATC)..... 67
  - Automatic Transmission..... 153
    - Adding Fluid ..... 377
    - Fluid And Filter Change..... 377
    - Fluid Change..... 377
    - Fluid Level Check..... 376, 377
    - Fluid Type ..... 377, 426
    - Gear Ranges..... 153
    - Special Additives ..... 376
  - Automatic Transmission Limp Home Mode... 156
  - AutoPark ..... 140
  - Auxiliary Electrical Outlet (Power Outlet) ..... 71
  - Auxiliary Power Outlet ..... 71
  - Auxiliary Switches ..... 73
  - Axle Fluid..... 426
  - Axle Lock..... 161, 162
- B**
- Battery ..... 129, 358
    - Charging System Light ..... 129
    - Keyless Key Fob Replacement ..... 17
  - Belts, Seat ..... 327
  - Blind Spot Monitoring ..... 284



Bluetooth			
Connecting To A Particular Mobile Phone			
Or Audio Device After Pairing .....	243		
Body Mechanism Lubrication .....	368		
B-Pillar Location.....	395		
Brake Assist System .....	276		
Brake Control System.....	276		
Brake Fluid .....	375, 426		
Brake System .....	374, 417		
Anti-Lock (ABS).....	417		
Fluid Check .....	375		
Master Cylinder .....	375		
Parking.....	148		
Warning Light.....	128		
Brake/Transmission Interlock .....	153		
Bulb Replacement.....	387, 389		
Bulbs, Light.....	329, 387		
Bumper End Cap Removal.....	201		
<b>C</b>			
Camera, Rear .....	184		
Capacities, Fluid .....	423		
Caps, Filler			
Fuel .....	186		
Oil (Engine).....	355		
Radiator (Coolant Pressure).....	373		
Car Washes .....	409		
Carbon Monoxide Warning .....	329		
Cargo Area Cover.....	114		
Cargo Load Floor .....	114		
Cargo Tie-Downs .....	114		
Carpeting .....	411		
CD .....	236		
Cellular Phone .....	272		
Center High Mounted Stop Light.....	390		
Certification Label.....	191		
Chains, Tire.....	405		
Chart, Tire Sizing.....	392		
Check Engine Light (Malfunction Indicator Light).....	138		
Checking Your Vehicle For Safety .....	327		
Checks, Safety .....	327		
Child Restraint .....	314		
Child Restraints			
Booster Seats.....	317		
Child Seat Installation .....	324		
How To Stow An unused ALR Seat Belt ....	322		
Infant And Child Restraints.....	316		
Locating The LATCH Anchorages .....	320		
Lower Anchors And Tethers For Children..	318		
Older Children And Child Restraints .....	316		
Seating Positions.....	317		
Clean Air Gasoline.....	418		
Cleaning			
Wheels .....	404		
Climate Control			
Automatic .....	62		
Manual .....	65		
Cold Weather Operation .....	141		
Compact Spare Tire .....	403		
Connected Services .....	254		
Connected Services FAQ .....	267		
Connected Services Features .....	257		
Connected Services, Getting Started .....	256		
Connected Services, Introduction .....	254		
Connector			
UCL .....	69		
Universal Consumer Interface (UCI).....	69		
Console .....	69		
Floor .....	69		
Contract, Service.....	429		
Controls .....	227		
Cooling Pressure Cap (Radiator Cap).....	373		
Cooling System .....	371		
Adding Coolant (Antifreeze) .....	372		
Coolant Level .....	373		
Cooling Capacity .....	423		
Disposal Of Used Coolant .....	373		
Drain, Flush, And Refill .....	372		
Inspection .....	371, 373		
Points To Remember .....	374		
Pressure Cap .....	373		
Radiator Cap.....	373		
Selection Of Coolant (Antifreeze).....	372, 423, 424		
Corrosion Protection .....	408		
Cruise Control (Speed Control).....	169, 171		
Cruise Light.....	136, 137		

Customer Assistance .....	428	Door Frame .....	106	Emergency, In Case Of	
Customer Programmable Features.....	208	Installation .....	106	Jacking.....	333
Cybersecurity.....	207	Removal .....	106	Jump Starting .....	338
<b>D</b>		Door Locks		Tow Hooks .....	345
Daytime Running Lights.....	58	Automatic .....	28	Emission Control System Maintenance.....	138
Dealer Service .....	359	Door Off Mirror Kit .....	34	Engine.....	355
Defroster, Windshield .....	327	Door Off Mirror Kit — If Equipped  .....	34	Air Cleaner .....	360
Delay (Intermittent) Wipers.....	60	Doors .....	25	Block Heater .....	143
Deleting A Phone .....	243	Removal .....	29, 32	Break-In Recommendations .....	147
Diagnostic System, Onboard .....	137	Removal, Front.....	29	Checking Oil Level .....	358
Diesel		Removal, Rear.....	32	Compartment .....	355, 356, 357
Display Messages .....	126, 127	Drag & Drop.....	225	Compartment Identification.....	355, 356, 357
Diesel Fuel.....	420	Draining Fuel/Water Separator Filter.....	362	Coolant (Antifreeze) .....	424
Diesel Fuel Requirements .....	420	Driver Memory Presets .....	233	Cooling.....	371
Bulk Storage Of .....	188	Driver's Seat Back Tilt.....	43, 44	Exhaust Gas Caution .....	329
Diesel Fuel System, Re-Priming .....	364	Driving .....	200	Fails To Start.....	142
Dimmer Switch		<b>E</b>		Flooded, Starting .....	142
Headlight.....	58	Electric Brake Control System.....	276	Fuel Requirements .....	418, 423
Dipsticks		Anti-Lock Brake System.....	275	Idling.....	145
Oil (Engine).....	358	Electronic Roll Mitigation.....	276, 284	Jump Starting .....	338
Disable Vehicle Towing.....	344	Electric Remote Mirrors .....	53	Oil .....	360, 423, 424
Disc Drive .....	236	Electrical Outlet, Auxiliary (Power Outlet) .....	71	Oil Filler Cap .....	355
Disconnecting.....	243	Electrical Power Outlets .....	71	Oil Filter .....	360
Disposal		Electronic Stability Control (ESC) .....	277	Oil Reset .....	121
Antifreeze (Engine Coolant).....	373	Electronic Throttle Control Warning Light.....	129	Oil Selection.....	360, 423
Disturb.....	246	Emergency		Oil Synthetic.....	360
Door Ajar.....	129, 130	In Case Of.....	330	Overheating .....	341
Door Ajar Light.....	129, 130	SOS Emergency Call .....	330	Starting.....	139
		Emergency Brake.....	148	Enhanced Accident Response	
				Feature .....	313, 346

Ethanol .....	419	Fluid Level Checks .....	375	Materials Added .....	418
Exhaust Gas Caution .....	329	Brake.....	375	Methanol .....	419
Exhaust Gas Cautions.....	329	Engine Oil .....	358	Octane Rating.....	418, 424
Exhaust System .....	329, 370	Fluid, Brake .....	426	Requirements .....	420, 423
Exterior Lights.....	57, 329	Fog Lights .....	389	Specifications .....	421, 424
<b>F</b>		Fog Lights, Service.....	389	Tank Capacity .....	423
Fabric Care .....	409	Fold And Tumble Rear Seat .....	45	Fueling .....	186, 187
Fabric Top.....	409	Fold-Flat Seats .....	43	Fuses .....	377
Family Alerts.....	266	Folding Rear Seats.....	45	<b>G</b>	
Filters		Folding Windshield .....	109	Garage Door Opener (HomeLink) .....	53
Air Cleaner.....	360	Forward Collision Warning .....	288	Gas Cap (Fuel Filler Cap).....	186, 187
Air Conditioning.....	68, 367	Four Wheel Drive .....	157	Gasoline, (Fuel).....	418
Engine Fuel .....	362	Operation .....	157	Gasoline, Clean Air.....	418
Engine Oil .....	360, 424	Shifting.....	157	Gasoline, Reformulated .....	418
Engine Oil Disposal .....	360	System .....	157	Gauges	
Flashers		Four Wheel Drive Operation.....	159	Voltage.....	144
Hazard Warning.....	330	Four-Way Hazard Flasher .....	330	Gear Ranges .....	150, 153
Turn Signal .....	329	Freedom Panels.....	96	Glass Cleaning .....	416
Turn Signals .....	136, 389, 390	Freeing A Stuck Vehicle .....	343	Gross Vehicle Weight Rating .....	192
Flash-To-Pass .....	58	Front Axle (Differential) .....	375	GVWR .....	191
Flat Tire Changing.....	391, 402	Fuel.....	418, 420		
Flat Tire Stowage .....	391, 402	Adding .....	186, 187	<b>H</b>	
Flooded Engine Starting .....	142	Additives.....	418	Half-Door Installation .....	36
Fluid Capacities .....	423	Clean Air .....	418	Half-Door Installation — If Equipped  .....	36
Fluid Leaks .....	329	Ethanol.....	419	Hard Top .....	76
Fluid Level		Filler Cap (Gas Cap).....	186	Hard Top Front Panel(s) Removal  .....	93
Manual Transmission.....	376	Filter .....	362	Hazard Warning Flashers .....	330
		Gasoline .....	418	Head Restraints .....	48

Headlights	Instrument Cluster .....	116	Keyless Enter'n Go™ .....	26
Automatic.....	Descriptions .....	136	Passive Entry .....	26
Bulb Replacement.....	Display.....	120	Keys .....	16
Cleaning.....	Engine Oil Reset .....	121	Replacement .....	18
High Beam/Low Beam Select Switch .....	Menu Items .....	122	<b>L</b>	
Lights On Reminder.....	Instrument Panel Lens Cleaning.....	416	Lane Change Assist.....	59
Passing.....	Integrated Power Module (Fuses).....	378	Lap/Shoulder Belts .....	296
Replacing .....	Interior And Instrument Lights .....	59	Latches .....	329
Heated Mirrors .....	Interior Appearance Care .....	411	Hood .....	112, 130
Heated Seats.....	Interior Lights.....	59	Leaks, Fluid.....	329
Heated Steering Wheel.....	Intermittent Wipers (Delay Wipers) .....	60	Life Of Tires.....	400
High Beam/Low Beam Select (Dimmer)	Intervention Regeneration Strategy .....	365	Light Bulbs .....	329, 387
Switch.....	Inverter		Lights .....	329
Hill Descent Control.....	Power .....	72	Air Bag.....	128, 302, 327
Hill Descent Control Indicator .....	<b>J</b>		Automatic Headlights .....	58
Hill Start Assist .....	Jack Location .....	334	Brake Assist Warning.....	279
Hitches	Jack Operation .....	335	Brake Warning.....	128
Trailer Towing.....	Jacking Instructions .....	335	Bulb Replacement .....	387, 389
HomeLink (Garage Door Opener) .....	Jump Starting .....	338	Center Mounted Stop .....	390
Hood Prop.....	<b>K</b>		Cruise .....	136, 137
Hood Release .....	Key Fob		Daytime Running.....	58
<b>I</b>	Arm The System .....	24	Dimmer Switch, Headlight .....	58
Ignition .....	Disarm The System .....	24	Electric Power Steering.....	129
Switch .....	Programming Additional Key Fobs.....	18	Electronic Stability Program (ESP)	
In Case Of Emergency .....	Key Fob Battery Service (Remote Keyless		Indicator .....	130, 131
Inside Rearview Mirror.....	Entry) .....	17	Exterior .....	57, 329
	Key Fob Programming (Remote Keyless		Fog.....	389
	Entry) .....	18	Fuel Filler Cap.....	132
			Hazard Warning Flasher .....	330

Headlights.....	389	Loading Vehicle .....	191	Mirrors .....	51
High Beam .....	58	Tires .....	395	Automatic Dimming .....	51
High Beam/Low Beam Select .....	58	Locking .....		Electric Powered .....	53
Hill Descent Control Indicator.....	279	Axle.....	161, 162	Electric Remote .....	53
Interior .....	59	Locks .....		Heated.....	53
Lights On Reminder.....	59	Automatic Door.....	28	Outside .....	52
Low Fuel.....	132	Child Protection .....	28	Rearview.....	51
Low Washer Fluid.....	132	Power Door.....	26	Vanity.....	52
Malfunction Indicator (Check Engine) .....	132	Low Tire Pressure System.....	290	Mobile App.....	256
Oil Temperature .....	130	Lowering The Soft Top Into Sunrider®		Modifications/Alterations	
Park.....	136	Position  .....	76	Vehicle.....	11
Passing.....	58	Lubrication, Body.....	368	Monitor, Tire Pressure System .....	290
Rear Servicing.....	390	Lug Nuts/Bolts.....	417	Mopar Parts .....	430
Rear Tail Lamps .....	390	Luggage Carrier .....	114		
Seat Belt Reminder.....	130			<b>N</b>	
Security Alarm .....	131			New Vehicle Break-In Period .....	147
Service .....	387, 389	<b>M</b>			
Side Marker.....	390	Maintenance.....	102	<b>O</b>	
Tire Pressure Monitoring (TPMS).....	290	Maintenance Free Battery .....	358	Occupant Restraints .....	295
Traction Control.....	279	Maintenance Schedule.....	347, 351	Octane Rating, Gasoline (Fuel).....	418, 424
Transmission Temperature .....	131	Malfunction Indicator Light (Check		Off Road Pages .....	272
Turn Signal .....	329	Engine) .....	132, 138	Accessory Gauges.....	272, 274
Turn Signals .....	136, 389, 390	Manual .....		Drivetrain.....	272, 273
Warning Instrument Cluster		Park Release .....	341	Pitch And Roll .....	272, 274
Descriptions.....	130, 136	Service .....	430	Status Bar.....	272, 273
Load Floor, Cargo .....	114	Manual Transmission .....	149, 376	Oil Filter, Change.....	360
Load Shed Battery Saver Mode .....	125	Fluid Level Check .....	376	Oil Filter, Selection .....	360
Load Shed Battery Saver On.....	125	Lubricant Selection .....	376, 426	Oil Pressure Light.....	130
Load Shed Electrical Load Reduction .....	125	Shift Speeds.....	150	Oil Reset .....	121
Load Shed Intelligent Battery Sensor .....	125	Media Mode.....	236	Oil, Engine.....	360, 424
		Methanol .....	419		

Capacity .....	423	Placard, Tire And Loading Information.....	395	Rear Axle (Differential) .....	375
Checking .....	358	Power		Rear Camera .....	184
Dipstick .....	358	Brakes .....	417	Rear Cross Path .....	287
Disposal .....	360	Door Locks .....	26	Rear ParkSense System.....	180
Filter.....	360, 424	Inverter.....	72	Rear Seat Reminder Alert .....	282
Filter Disposal .....	360	Mirrors.....	53	Rear Swing Gate .....	113
Identification Logo.....	360	Steering.....	164	Rear Wiper/Washer .....	61
Materials Added To .....	360	Windows.....	75	Recreational Towing.....	198
Pressure Warning Light .....	130	Power Sliding Top .....	102	Shifting Into Transfer Case Neutral (N).....	199
Recommendation.....	360, 423	Operation .....	102	Shifting Out Of Transfer Case	
Synthetic .....	360	Pinch Protect.....	102	Neutral (N).....	200
Viscosity .....	423	Quarter Window Removal.....	104	Reformulated Gasoline .....	418
Onboard Diagnostic System .....	137	Power Steering Fluid.....	426	Refrigerant.....	367
Operating Precautions .....	137	Power Top Quarter Windows.....	104	Registering SiriusXM Guardian .....	255
Operator Manual		Pregnant Women And Seat Belts.....	300	Release, Hood.....	112
Owner's Manual .....	430	Preparation For Jacking .....	333	Reminder, Seat Belt.....	296
Outside Rearview Mirrors .....	52	Presets .....	233	Remote Control	
Overheating, Engine .....	341	Pretensioners		Starting System .....	21
		Seat Belts.....	300	Remote Features, Door Lock/Unlock...	261, 267
<b>P</b>		<b>R</b>		Remote Features, Horn And Lights .....	262
Paddle Shifters .....	156	Radial Ply Tires .....	399	Remote Features, Starting.....	261, 269
Paint Care .....	408	Radiator Cap (Coolant Pressure Cap) .....	373	Remote Keyless Entry	
Pair (Link) Uconnect Phone To A Mobile		Radio		Arm The Alarm .....	24
Phone  .....	241	Presets .....	233	Disarm The Alarm .....	24
Parking Brake.....	148	Radio Controls .....	227	Programming Additional Key Fobs.....	18
ParkSense System, Rear .....	180	Radio Mode .....	227	Remote Sound System (Radio) Control.....	226
Passive Entry .....	26	Radio Operation.....	227, 272	Remote Start (Diesel).....	23
Personalized Main Menu Bar .....	225	Radio Remote Controls.....	226	Remote Start (Gas) .....	21
Pets .....	327	Raising The Soft Top  .....	87		
Phone Mode .....	239				



Remote Starting			
Exit Remote Start Mode .....	22		
Uconnect Customer Programmable			
Features.....	22		
Uconnect Settings.....	22		
Remote Starting System.....	21, 23		
Removable Doors .....	29, 32		
Front.....	29		
Rear .....	32		
Removable Top.....	102		
Removing The Soft Top  .....	90		
Replacement Bulbs .....	387		
Replacement Keys.....	18		
Replacement Tires.....	401		
Reporting Safety Defects.....	430		
Restraints, Child .....	314		
Restraints, Head.....	48		
Roadside Assistance .....	262, 268		
Roll Over Warning.....	10		
Roof Type Carrier.....	114		
Rotation, Tires .....	406		
<b>S</b>			
Safety .....	225		
Safety Checks Inside Vehicle.....	327		
Safety Checks Outside Vehicle .....	329		
Safety Defects, Reporting.....	430		
Safety Features .....	225		
Safety Information, Tire .....	391		
Safety Tips.....	327		
Safety, Exhaust Gas.....	329		
Satellite Radio .....	228		
Saved Radio Stations .....	233		
Schedule, Maintenance.....	347, 351		
Seat Belt Reminder.....	130		
Seat Belts .....	296, 327		
Adjustable Shoulder Belt.....	299		
Adjustable Upper Shoulder Anchorage.....	299		
Adjustable Upper Shoulder Belt			
Anchorage.....	299		
Automatic Locking Retractor (ALR).....	300		
Child Restraints.....	314		
Energy Management Feature .....	300		
Extender .....	300		
Front Seat.....	296, 298		
Inspection.....	327		
Lap/Shoulder Belt Operation.....	298		
Lap/Shoulder Belt Untwisting.....	299		
Lap/Shoulder Belts .....	296		
Operating Instructions .....	298		
Pregnant Women.....	300		
Pretensioners .....	300		
Rear Seat .....	296		
Reminder.....	296		
Seat Belt Extender.....	300		
Seat Belt Pretensioner .....	300		
Untwisting Procedure .....	299		
Seat Belts Maintenance .....	415		
Seats.....	43		
Adjustment .....	43		
Fold And Tumble Rear .....	45		
Heated.....	47		
Height Adjustment.....	43		
Rear Folding .....	43		
Tilting.....	43		
Security Alarm.....	24, 131		
Arm The System.....	24		
Disarm The System.....	24		
Selec - Speed Control.....	282		
Selection Of Coolant (Antifreeze) .....	424		
Send & Go.....	263, 268		
Sentry Key (Immobilizer) .....	18		
Sentry Key Replacement.....	18		
Service Assistance .....	428		
Service Contract.....	429		
Service Manuals .....	430		
Settings.....	207		
Settings, Audio .....	234		
Shifting.....	151		
Automatic Transmission .....	151, 153		
Manual Transmission .....	149		
Transfer Case, Shifting Into Transfer			
Case Neutral (N).....	199		
Transfer Case, Shifting Out Of Transfer			
Case Neutral (N).....	200		
Shoulder Belts .....	296		
Side Step Removal.....	200		

Signals, Turn.....	136, 329, 389, 390	Engine Fails To Start.....	142	<b>T</b>	
Sirius Satellite Radio .....	228	Manual Transmission.....	139	Telescoping Steering Column.....	42
Favorites .....	231	Remote.....	21	Temperature Control, Automatic (ATC).....	67
Replay .....	230	Starting And Operating.....	139	Tie Down Hooks, Cargo .....	114
SiriusXM Satellite Radio		Starting Procedures .....	139, 142	Tilt Steering Column.....	42
Browse in SXM .....	231	Starting Procedures (Diesel Engines) .....	142	Tire And Loading Information Placard .....	395
Favorites .....	231	Steering .....	42	Tire Markings .....	391
Replay .....	230	Power .....	164	Tire Safety Information.....	391
Smart Watch.....	267	Tilt Column .....	42	Tires .....	329, 398, 402, 406
Snow Chains (Tire Chains).....	405	Wheel, Heated.....	42	Aging (Life Of Tires).....	400
Snow Tires.....	402	Wheel, Tilt.....	42	Air Pressure .....	398
Soft Top .....	76, 84	Steering Wheel Audio Controls .....	226	Chains .....	405
Soft Top Windows.....	84	Steering Wheel Mounted Sound System .....	226	Changing .....	333
SOS Call.....	257, 267	Stolen Vehicle Assistance .....	264, 269	Compact Spare.....	403
Spare Tires .....	335, 402, 403	Stop/Start.....	165, 167	General Information .....	398, 402
Specifications		Storage .....	69, 84, 104	High Speed .....	399
Fuel (Gasoline).....	424	Behind the Seat.....	69	Inflation Pressure .....	398
Oil.....	424	Storage, Vehicle .....	407	Life Of Tires .....	400
Speed Control		Store Radio Presets .....	233	Load Capacity.....	395
Accel/Decel.....	171	Storing Your Vehicle.....	407	Pressure Monitoring System	
Accel/Decel (ACC Only) .....	175	Stuck, Freeing.....	343	(TPMS).....	133, 290
Cancel .....	171	Sun Roof.....	102	Quality Grading .....	406
Resume.....	171	Sunrider® For Hard Top.....	99	Radial .....	399
Speed Control (Cruise Control) .....	171	Sway Bar Disconnect		Replacement .....	401
Starting.....	139, 142	Electronic .....	162	Rotation .....	406
Automatic Transmission.....	139, 143	Sway Control, Trailer .....	284	Safety .....	391, 398
Button .....	19	Swing Gate, Rear .....	113	Sizes .....	392
Cold Weather .....	141	Synthetic Engine Oil.....	360	Snow Tires .....	402
Engine Block Heater.....	143	System, Remote Starting.....	21	Spare Tires .....	335, 402, 403

Spinning.....	400	Trailer Weight.....	194	Call Continuation .....	248
Tread Wear Indicators.....	400	Transfer Case .....	376	Call Controls .....	245
Wheel Nut Torque .....	417	Fluid .....	426	Call Termination .....	247
To Open Hood.....	112	Four-Wheel-Drive-Operation .....	157, 159	Cancel Command .....	241
Tongue Weight/Trailer Weight .....	194	Maintenance .....	376	Connecting To A Particular Mobile	
Top		Transmission .....	153	Phone Or Audio Device After Pairing.....	243
Dual.....	76	Automatic.....	153, 376	Help Command.....	240
Hard .....	76	Fluid .....	426	Join Calls .....	247
Power Sliding .....	102	Maintenance .....	376	Making A Phone Or Audio Device A	
Removable.....	76	Manual.....	149	Favorite .....	243
Soft .....	76	Shifting.....	151	Making A Second Call While Current	
Tow Hooks		Transporting Pets.....	327	Call Is In Progress.....	247
Emergency .....	345	Tread Wear Indicators .....	400	Managing Your Favorites .....	244
Towing.....	192, 194, 344	Turn Signals.....	136, 389, 390	Natural Speech.....	240
Disabled Vehicle.....	344	<b>U</b>		Operation.....	240
Recreational.....	198	UCI Connector.....	69	Overview .....	239
Weight.....	194	Uconnect		Pair (Link) Uconnect Phone To A Mobile	
Towing Behind A Motorhome.....	198	Phone Call Features .....	244	Phone.....	241
Trac-Lok		Things You Should Know About Your		Pair A Bluetooth Streaming Audio	
Rear Axle .....	161	Uconnect Phone.....	248	Device .....	242
Traction Control .....	284	Uconnect Settings .....	22	Phonebook Download.....	244
Trailer Sway Control (TSC) .....	284	Uconnect Phone .....	240, 241, 242	Place/Retrieve A Call From Hold.....	247
Trailer Towing .....	192	Answer Or Ignore An Incoming Call —		Power-Up .....	250
Hitches.....	193	Call Currently In Progress.....	246	Recent Calls.....	245
Minimum Requirements.....	195	Answer Or Ignore An Incoming Call —		Redial .....	247
Trailer And Tongue Weight .....	194	No Call Currently In Progress.....	246	To Remove A Favorite .....	244
Wiring.....	196	Bluetooth Communication Link .....	250	Toggleing Between Calls.....	247
Trailer Towing Guide .....	194			Touch-Tone Number Entry .....	245
				Transfer Call To And From Mobile Phone..	248
				Voice Command .....	248

Uconnect Settings .....	207, 208
Customer Programmable	
Features.....	22, 26, 208
Passive Entry Programming.....	26
Uconnect System.....	222
Uniform Tire Quality Grades.....	406
Universal Consumer Interface (UCI) Connector .....	69
Universal Garage Door Opener (HomeLink®) – If Equipped  .....	53
Untwisting Procedure, Seat Belt .....	299
USB .....	69
USB Port .....	69

**V**

Vanity Mirrors .....	52
Vehicle Finder .....	263, 268
Vehicle Health Alert .....	265
Vehicle Health Report .....	265
Vehicle Identification Number (VIN) .....	417
Vehicle Loading .....	191, 395
Vehicle Maintenance .....	359
Vehicle Modifications/Alterations .....	11
Vehicle Notifications .....	265
Vehicle Settings .....	207
Vehicle Storage.....	407
Voice Command.....	50, 251, 253
Climate.....	67
Voice Recognition .....	50
Voice Recognition System (VR) .....	50

**W**

Warning Lights (Instrument Cluster Descriptions).....	132
Warnings, Roll Over.....	10
Warranty Information .....	429
Washers, Windshield .....	358
Washing Vehicle.....	409
Water Separator	
Diesel Fuel.....	362
Wheel And Wheel Tire Care.....	404
Wheel And Wheel Tire Trim .....	404
Wi-Fi.....	263
Wind Buffeting .....	76
Window Fogging.....	68
Window Storage.....	84
Windows .....	75
Power.....	75
Windshield	
Folding.....	109
Windshield Defroster .....	327
Windshield Washers .....	60, 358
Fluid.....	358
Windshield Wiper Blades .....	368
Windshield Wipers .....	60
Wipers Blade Replacement.....	368
Wipers, Rear .....	61



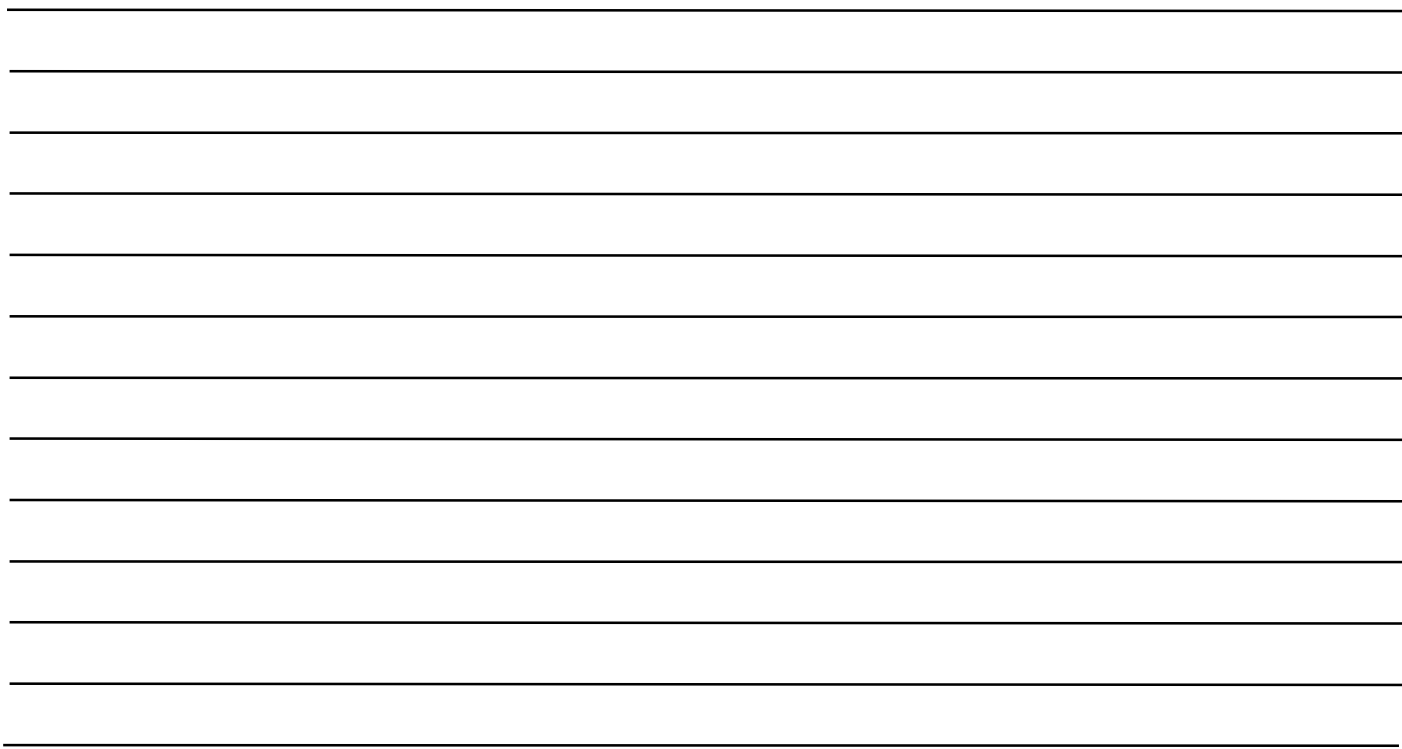

The driver's primary responsibility is the safe operation of the vehicle. Driving while distracted can result in loss of vehicle control, resulting in an accident and personal injury. FCA US LLC strongly recommends that the driver use extreme caution when using any device or feature that may take their attention off the road. Use of any electrical devices, such as cellular telephones, computers, portable radios, vehicle navigation or other devices, by the driver while the vehicle is moving is dangerous and could lead to a serious accident. Texting while driving is also dangerous and should never be done while the vehicle is moving. If you find yourself unable to devote your full attention to vehicle operation, pull off the road to a safe location and stop your vehicle. Some states or provinces prohibit the use of cellular telephones or texting while driving. It is always the driver's responsibility to comply with all local laws.

This Owner's Manual has been prepared to help you get acquainted with your new Jeep® brand vehicle and to provide a convenient reference source for common questions.

Not all features shown in this manual may apply to your vehicle. For additional information, visit [mopar.com/om](https://mopar.com/om) (U.S.), [owners.mopar.ca](https://owners.mopar.ca) (Canada) or your local Jeep® brand dealer.

## DRIVING AND ALCOHOL

Drunk driving is one of the most frequent causes of accidents. Your driving ability can be seriously impaired with blood alcohol levels far below the legal minimum. If you are drinking, don't drive. Ride with a designated non-drinking driver, call a cab, a rideshare, a friend or use public transportation.

## WARNING

Driving after drinking can lead to an accident. Your perceptions are less sharp, your reflexes are slower and your judgment is impaired when you have been drinking. Never drink and then drive.



**Jeep**  
VEHICLE OWNERS

Whether it's providing information about specific product features, taking a tour through your vehicle's heritage, knowing what steps to take following an accident or scheduling your next appointment, we know you'll find the app an important extension of your Jeep® brand vehicle. Simply download the app, select your make and model and enjoy the ride. To get this app, go directly to the App Store® or Google Play® Store and enter the search keyword "JEEP" (U.S. residents only).

U. S.



[mopar.com/om](https://mopar.com/om)

**DOWNLOAD THE MOST UP-TO-DATE OWNER'S MANUAL,  
RADIO AND WARRANTY BOOKS**

Canada



[owners.mopar.ca](https://owners.mopar.ca)