



2024 CHRYSLER PACIFICA | **OWNER'S MANUAL**

## ROADSIDE ASSISTANCE

24 HOURS, 7 DAYS A WEEK AT YOUR SERVICE.

CALL 1-800-521-2779 OR VISIT [CHRYSLER.RSAHELP.COM](http://CHRYSLER.RSAHELP.COM) (USA)  
CALL 1-800-363-4869 OR VISIT [FCA.ROADSIDEAID.COM](http://FCA.ROADSIDEAID.COM) (CANADA)

**SERVICES: Flat Tire Service, Out Of Gas/Fuel Delivery, Battery Jump Assistance, Lockout Service and Towing Service**

Please see the Customer Assistance chapter in this Owner's Manual for further information.

FCA US LLC reserves the right to modify the terms or discontinue the Roadside Assistance Program at any time. The Roadside Assistance Program is subject to restrictions and conditions of use, that are determined solely by FCA US LLC.

Vehicle images are for illustration purposes only. Actual products sold may vary.

This Owner's Manual illustrates and describes the operation of features and equipment that are either standard or optional on this vehicle. This manual may also include a description of features and equipment that are no longer available or were not ordered on this vehicle. Please disregard any features and equipment described in this manual that are not on this vehicle. FCA US LLC reserves the right to make changes in design and specifications, and/or make additions to or improvements to its products without imposing any obligation upon itself to install them on products previously manufactured.

With respect to any vehicles sold in Canada, the name FCA US LLC shall be deemed to be deleted and the name FCA Canada Inc. used in substitution therefore.

This Owner's Manual is intended to familiarize you with the important features of your vehicle. Your most up-to-date Owner's Manual, Radio Instruction Manual and Warranty Booklet can be found by visiting the website on the back cover.

**⚠ WARNING:** Operating, servicing and maintaining a passenger vehicle or off-highway motor vehicle can expose you to chemicals including engine exhaust, carbon monoxide, phthalates, and lead, which are known to the State of California to cause cancer and birth defects or other reproductive harm. To minimize exposure, avoid breathing exhaust, do not idle the engine except as necessary, service your vehicle in a well-ventilated area and wear gloves or wash your hands frequently when servicing your vehicle. For more information go to [www.P65Warnings.ca.gov/passenger-vehicle](http://www.P65Warnings.ca.gov/passenger-vehicle).



# TABLE OF CONTENTS

1	INTRODUCTION.....	7
2	GETTING TO KNOW YOUR VEHICLE.....	13
3	GETTING TO KNOW YOUR INSTRUMENT PANEL .....	99
4	STARTING AND OPERATING .....	119
5	MULTIMEDIA .....	169
6	SAFETY.....	194
7	IN CASE OF EMERGENCY.....	241
8	SERVICING AND MAINTENANCE .....	264
9	TECHNICAL SPECIFICATIONS.....	309
10	CUSTOMER ASSISTANCE .....	315
11	INDEX .....	320

1

2

3

4

5

6

7

8

9

10

11

## INTRODUCTION

<b>SYMBOLS KEY</b> . . . . .	<b>8</b>
<b>VEHICLE MODIFICATIONS/ALTERATIONS</b> . . . . .	<b>8</b>
<b>SYMBOL GLOSSARY</b> . . . . .	<b>8</b>

## GETTING TO KNOW YOUR VEHICLE

<b>HIGH VOLTAGE BATTERY</b> . . . . .	<b>13</b>
Battery Conditioning . . . . .	14

<b>HIGH VOLTAGE CHARGING OPERATION</b> . . . . .	<b>15</b>
SAE J1772 Charging Inlet . . . . .	15
AC Level 1 Charging (120 Volt, 12 Amp) . . . . .	15
AC Level 2 Charging (240 Volt, 32 Amp) . . . . .	16
Vehicle Charge Indicators . . . . .	17
Hybrid Electric App . . . . .	18

<b>KEYS</b> . . . . .	<b>20</b>
Key Fob . . . . .	20

<b>SENTRY KEY</b> . . . . .	<b>22</b>
-----------------------------	-----------

<b>IGNITION SWITCH</b> . . . . .	<b>23</b>
Keyless Enter 'n Go™ Ignition . . . . .	23
Keyless Enter 'n Go™ Ignition — Hybrid Models Only . . . . .	24

<b>REMOTE START — IF EQUIPPED</b> . . . . .	<b>25</b>
How To Use Remote Start . . . . .	25
To Exit Remote Start Mode . . . . .	26
Remote Start Front Defrost Activation — If Equipped . . . . .	26
Remote Start Comfort Systems — If Equipped . . . . .	26
Remote Start Windshield Wiper . . . . .	26
De-Icer Activation — If Equipped . . . . .	27
Remote Start Cancel Message . . . . .	27

<b>REMOTE START SYSTEM (BEV) — IF EQUIPPED</b> . . . . .	<b>27</b>
How To Use Remote Start . . . . .	27
To Exit Remote Start Mode . . . . .	28
Scheduled Cabin Conditioning (SCC) . . . . .	28

<b>VEHICLE SECURITY SYSTEM — IF EQUIPPED</b> . . . . .	<b>29</b>
To Arm The System . . . . .	30
To Disarm The System . . . . .	30
Rearming Of The System . . . . .	30
Security System Manual Override . . . . .	30

<b>DOORS</b> . . . . .	<b>30</b>
Manual Door Locks . . . . .	30
Power Door Locks — If Equipped . . . . .	31
Keyless Enter 'n Go™ — Passive Entry . . . . .	31
Automatic Unlock Doors On Exit — If Equipped . . . . .	33
Manual Sliding Side Door . . . . .	33
Power Sliding Side Door — If Equipped . . . . .	34
Hands-Free Sliding Doors — If Equipped . . . . .	35
Child Protection Door Lock System — Rear Doors . . . . .	35

<b>STEERING WHEEL</b> . . . . .	<b>36</b>
Tilt/Telescoping Steering Column . . . . .	36
Heated Steering Wheel — If Equipped . . . . .	36

<b>DRIVER MEMORY SETTINGS — IF EQUIPPED</b> . . . . .	<b>37</b>
Programming The Memory Feature . . . . .	37
Linking And Unlinking The Key Fob To Memory . . . . .	37
Memory Position Recall . . . . .	38

<b>SEATS</b> . . . . .	<b>38</b>
Manual Adjustment Front Seats — If Equipped . . . . .	38
Manual Adjustment Rear Seats . . . . .	39
Power Adjustment Front Seats — If Equipped . . . . .	49
Power Adjustment Rear Seats — If Equipped . . . . .	50
Heated Seats . . . . .	52
Ventilated Seats — If Equipped . . . . .	53

Plastic Grocery Bag Retainer Hooks . . . . .	53
Head Restraints . . . . .	53

<b>Uconnect Voice Recognition — If Equipped</b> . . . . .	<b>55</b>
Introducing Voice Recognition . . . . .	55
Basic Voice Commands . . . . .	55
Get Started . . . . .	55
Additional Information . . . . .	56

<b>MIRRORS</b> . . . . .	<b>56</b>
Inside Rearview Mirror . . . . .	56
Illuminated Vanity Mirrors — If Equipped . . . . .	57
Outside Mirrors . . . . .	57
Outside Mirrors With Turn Signal And Approach Lighting — If Equipped . . . . .	57
Driver's Outside Automatic Dimming Mirror — If Equipped . . . . .	57
Conversation Mirror . . . . .	57
Power Mirrors — If Equipped . . . . .	57
Power Folding Outside Mirrors — If Equipped . . . . .	58
Automatic Power Folding Mirrors — If Equipped . . . . .	58
Outside Mirrors Folding Feature . . . . .	58
Heated Mirrors — If Equipped . . . . .	58
Tilt Side Mirrors In Reverse — If Equipped . . . . .	59

<b>UNIVERSAL GARAGE DOOR OPENER (HOMELINK®) — IF EQUIPPED</b> . . . . .	<b>59</b>
Before You Begin Programming HomeLink® . . . . .	59
Erasing All The HomeLink® Channels . . . . .	59
Identifying Whether You Have A Rolling Code Or Non-Rolling Code Device . . . . .	59
Programming HomeLink® To A Garage Door Opener . . . . .	60
Programming HomeLink® To A Miscellaneous Device . . . . .	60
Reprogramming A Single HomeLink® Button . . . . .	61

Canadian/Gate Operator Programming . . . . .	61	<b>INTERIOR STORAGE AND EQUIPMENT . . . . .</b>	<b>77</b>	<b>GETTING TO KNOW YOUR INSTRUMENT PANEL</b>	
Security . . . . .	61	Storage . . . . .	77	<b>INSTRUMENT CLUSTER . . . . .</b>	<b>99</b>
Troubleshooting Tips . . . . .	61	Lighted Cupholders — If Equipped . . . . .	79	Instrument Cluster Descriptions . . . . .	101
<b>EXTERIOR LIGHTS . . . . .</b>	<b>62</b>	Sun Screens — If Equipped . . . . .	79	<b>INSTRUMENT CLUSTER — HYBRID MODELS . . . . .</b>	<b>102</b>
Multifunction Lever . . . . .	62	USB/AUX Control . . . . .	80	Instrument Cluster Descriptions . . . . .	103
Headlight Switch . . . . .	62	Power Outlets . . . . .	81	<b>INSTRUMENT CLUSTER DISPLAY . . . . .</b>	<b>103</b>
Daytime Running Lights (DRLs) — If Equipped . . . . .	63	Power Inverter — If Equipped . . . . .	83	Instrument Cluster Display Location And Controls . . . . .	104
High/Low Beam Switch . . . . .	63	Wireless Charging Pad — If Equipped . . . . .	83	Stop Safely Vehicle Will Shut Off Soon . . . . .	104
Automatic High Beam — If Equipped . . . . .	63	<b>WINDOWS . . . . .</b>	<b>84</b>	Stop Safely And Leave The Vehicle As Soon As Possible . . . . .	104
Flash-To-Pass . . . . .	63	Power Windows . . . . .	84	Engine Oil Life . . . . .	105
Automatic Headlights — If Equipped . . . . .	64	Automatic Window Features . . . . .	85	Instrument Cluster Display Menu Items . . . . .	105
Headlights On With Wipers — If Equipped . . . . .	64	Reset Auto-Up . . . . .	85	Battery Saver On/Battery Saver Mode Message — Electrical Load Reduction Actions — If Equipped . . . . .	110
Headlight Time Delay — If Equipped . . . . .	64	Wind Buffeting . . . . .	85	<b>WARNING LIGHTS AND MESSAGES . . . . .</b>	<b>111</b>
Lights-On Reminder . . . . .	64	<b>PANORAMIC SUNROOF — IF EQUIPPED . . . . .</b>	<b>85</b>	Red Warning Lights . . . . .	111
Front Fog Lights — If Equipped . . . . .	64	Opening And Closing The Sunroof . . . . .	86	Yellow Warning Lights . . . . .	113
Turn Signals . . . . .	64	Opening And Closing The Power Sunshade — If Equipped . . . . .	86	Yellow Indicator Lights . . . . .	116
Lane Change Assist — If Equipped . . . . .	65	Pinch Protect Feature . . . . .	86	Green Indicator Lights . . . . .	116
Battery Saver . . . . .	65	Venting Sunroof . . . . .	87	White Indicator Lights . . . . .	117
<b>INTERIOR LIGHTS . . . . .</b>	<b>65</b>	Ignition Off Operation . . . . .	87	Blue Indicator Lights . . . . .	117
Interior Courtesy Lights . . . . .	65	Sunroof Maintenance . . . . .	87	<b>ONBOARD DIAGNOSTIC SYSTEM — OBD II . . . . .</b>	<b>117</b>
<b>WINDSHIELD WIPER AND WASHERS . . . . .</b>	<b>66</b>	<b>HOOD . . . . .</b>	<b>87</b>	Onboard Diagnostic System (OBD II) Cybersecurity . . . . .	118
Windshield Wiper Operation . . . . .	66	Opening . . . . .	87	<b>EMISSIONS INSPECTION AND MAINTENANCE PROGRAMS . . . . .</b>	<b>118</b>
Rain Sensing Wipers — If Equipped . . . . .	67	Closing . . . . .	88		
Rear Wiper And Washer . . . . .	67	<b>LIFTGATE . . . . .</b>	<b>88</b>		
<b>CLIMATE CONTROLS . . . . .</b>	<b>67</b>	To Unlock/Open The Liftgate . . . . .	88		
Automatic Climate Control Descriptions And Functions . . . . .	67	To Lock/Close The Liftgate . . . . .	88		
Manual Climate Control Descriptions And Functions . . . . .	72	Power Liftgate — If Equipped . . . . .	88		
Automatic Temperature Control (ATC) — If Equipped . . . . .	76	Hands-Free Liftgate — If Equipped . . . . .	89		
Climate Voice Commands . . . . .	76	Cargo Area Features . . . . .	91		
Operating Tips . . . . .	76	<b>STOW 'N PLACE ROOF RACK — IF EQUIPPED . . . . .</b>	<b>95</b>		
		Deploying The Crossbars . . . . .	95		
		Stowing The Crossbars . . . . .	96		

## STARTING AND OPERATING

<b>STARTING THE ENGINE</b> . . . . .	<b>119</b>	<b>ALL-WHEEL DRIVE (AWD) — IF EQUIPPED</b> . . . . .	<b>134</b>	LaneSense Warning Message . . . . .	153
Normal Starting . . . . .	119	<b>ACTIVE NOISE CANCELLATION</b> . . . . .	<b>134</b>	Changing LaneSense Status . . . . .	154
AutoPark . . . . .	119	<b>POWER STEERING</b> . . . . .	<b>134</b>	<b>PARKVIEW REAR BACK UP CAMERA</b> . . . . .	<b>154</b>
Extended Park Starting . . . . .	121	<b>STOP/START SYSTEM — IF EQUIPPED</b> . . . . .	<b>135</b>	<b>SURROUND VIEW CAMERA SYSTEM —</b>	
If Engine Fails To Start . . . . .	121	Autostop Mode . . . . .	135	<b>IF EQUIPPED</b> . . . . .	<b>155</b>
Cold Weather Operation		Possible Reasons The Engine Does Not		<b>FAMCAM SYSTEM — IF EQUIPPED</b> . . . . .	<b>157</b>
(Below -22°F Or -30°C) . . . . .	122	Autostop . . . . .	135	<b>REFUELING THE VEHICLE</b> . . . . .	<b>157</b>
After Starting — Warming Up The Engine . . . . .	122	To Start The Engine While In Autostop . . . . .	136	<b>REFUELING THE VEHICLE — HYBRID MODELS</b>	
To Turn Off The Engine Using The ENGINE		To Manually Turn Off The Stop/Start System . . . . .	136	<b>(IF EQUIPPED)</b> . . . . .	<b>158</b>
START/STOP Button . . . . .	122	To Manually Turn On The Stop/Start System . . . . .	136	<b>VEHICLE LOADING</b> . . . . .	<b>160</b>
<b>STARTING THE VEHICLE — HYBRID</b> . . . . .	<b>122</b>	System Malfunction . . . . .	136	Certification Label . . . . .	160
Normal Starting . . . . .	122	<b>CRUISE CONTROL SYSTEMS — IF EQUIPPED</b> . . . . .	<b>136</b>	<b>TRAILER TOWING</b> . . . . .	<b>160</b>
AutoPark . . . . .	123	Cruise Control . . . . .	137	Common Towing Definitions . . . . .	161
After Starting . . . . .	125	Adaptive Cruise Control (ACC) . . . . .	138	Trailer Hitch Classification . . . . .	162
To Turn Off The Vehicle Using ENGINE		<b>PARKSENSE FRONT/REAR PARK</b>		Trailer Towing Weights	
START/STOP Button . . . . .	125	<b>ASSIST SYSTEM — IF EQUIPPED</b> . . . . .	<b>145</b>	(Maximum Trailer Weight Ratings) . . . . .	162
<b>ENGINE BLOCK HEATER — IF EQUIPPED</b> . . . . .	<b>125</b>	ParkSense Sensors . . . . .	145	Vehicle Loading Chart . . . . .	163
<b>ENGINE BREAK-IN RECOMMENDATIONS</b> . . . . .	<b>126</b>	ParkSense Display . . . . .	145	Trailer And Tongue Weight . . . . .	164
<b>PARKING BRAKE</b> . . . . .	<b>126</b>	ParkSense Warning Display . . . . .	148	Towing Requirements . . . . .	164
Electric Park Brake (EPB) . . . . .	126	Enabling And Disabling ParkSense . . . . .	148	Towing Tips . . . . .	166
<b>AUTOMATIC TRANSMISSION</b> . . . . .	<b>128</b>	Service The ParkSense Park Assist System . . . . .	148	<b>TRAILER TOWING — HYBRID</b>	
Ignition Park Interlock . . . . .	129	Cleaning The ParkSense System . . . . .	148	<b>MODELS (IF EQUIPPED)</b> . . . . .	<b>166</b>
Brake/Transmission Shift Interlock (BTSI)		ParkSense System Usage Precautions . . . . .	148	<b>RECREATIONAL TOWING</b>	
System . . . . .	129	<b>PARKSENSE ACTIVE PARK ASSIST SYSTEM —</b>		<b>(BEHIND MOTORHOME)</b> . . . . .	<b>167</b>
9-Speed Automatic Transmission . . . . .	129	<b>IF EQUIPPED</b> . . . . .	<b>149</b>	Towing This Vehicle Behind Another Vehicle . . . . .	167
Gear Ranges . . . . .	129	Enabling And Disabling The ParkSense		<b>DRIVING TIPS</b> . . . . .	<b>168</b>
<b>AUTOMATIC TRANSMISSION — HYBRID</b> . . . . .	<b>131</b>	Active Park Assist System . . . . .	150	Driving On Slippery Surfaces . . . . .	168
Ignition Park Interlock . . . . .	132	Parallel/Perpendicular Parking Space		Driving Through Water . . . . .	168
Brake/Transmission Shift Interlock (BTSI)		Assistance Operation . . . . .	150		
System . . . . .	132	<b>LANESENSE — IF EQUIPPED</b> . . . . .	<b>152</b>		
Hybrid Transmission . . . . .	132	LaneSense Operation . . . . .	152		
Gear Ranges . . . . .	132	Turning LaneSense On Or Off . . . . .	153		

## MULTIMEDIA

<b>UCONNECT SYSTEMS</b> . . . . .	<b>169</b>
<b>CYBERSECURITY</b> . . . . .	<b>169</b>
<b>UCONNECT SETTINGS</b> . . . . .	<b>169</b>
Customer Programmable Features . . . . .	169
<b>STEERING WHEEL AUDIO CONTROLS</b> . . . . .	<b>185</b>
Radio Operation . . . . .	185
Media Mode . . . . .	185
<b>REAR SEAT ENTERTAINMENT (RSE) WITH AMAZON FIRE TV BUILT-IN — IF EQUIPPED</b> . . . . .	<b>185</b>
Overview . . . . .	185
Getting Started . . . . .	186
Accessing Rear Seat Entertainment with Fire TV built-in from the Front Radio Screen . . . . .	186
Accessing Rear Seat Entertainment with Fire TV built-in from the Rear Screens . . . . .	186
First Time Starting Up (Using the Rear Screens) . . . . .	186
Alexa Voice Control . . . . .	187
Listen Via Vehicle Speakers . . . . .	187
Quick Menu . . . . .	187
Parental Controls (Using the Rear Screens) . . . . .	187
Voice Remote with Alexa Pairing (Using the Rear Screens) . . . . .	187
Media Sources Input (Using the Front Radio and Rear Screens) . . . . .	188
Voice Remote with Alexa . . . . .	188
Rear Seat Entertainment with Fire TV built-in streaming (Using the Front Radio and Rear Screens) . . . . .	189
Play A Blu-ray™ or DVD — If Equipped . . . . .	190
Fire TV Apps/Games (Using the Rear Screens) . . . . .	190

Using The Video USB Port . . . . .	190
Play Video Games . . . . .	191
Headphones Operation . . . . .	191
Rear Climate Controls . . . . .	191
Legal & Compliance . . . . .	193
<b>RADIO OPERATION AND MOBILE PHONES</b> . . . . .	<b>193</b>
Regulatory And Safety Information . . . . .	193

## SAFETY

<b>SAFETY FEATURES</b> . . . . .	<b>194</b>
Anti-Lock Brake System (ABS) . . . . .	194
Regenerative Braking System (RBS) . . . . .	194
Audible Pedestrian Warning System . . . . .	195
Electronic Brake Control (EBC) System . . . . .	195
<b>AUXILIARY DRIVING SYSTEMS</b> . . . . .	<b>199</b>
Blind Spot Monitoring (BSM) — If Equipped . . . . .	199
Forward Collision Warning (FCW) With Mitigation — If Equipped . . . . .	202
Tire Pressure Monitoring System (TPMS) . . . . .	205
<b>OCCUPANT RESTRAINT SYSTEMS</b> . . . . .	<b>207</b>
Occupant Restraint Systems Features . . . . .	207
Important Safety Precautions . . . . .	207
Seat Belt Systems . . . . .	208
Supplemental Restraint Systems (SRS) . . . . .	216
Child Restraints . . . . .	225
<b>SAFETY TIPS</b> . . . . .	<b>238</b>
Transporting Passengers . . . . .	238
Transporting Pets . . . . .	238
Connected Vehicles . . . . .	238
Safety Checks You Should Make Inside The Vehicle . . . . .	238

Periodic Safety Checks You Should Make Outside The Vehicle . . . . .	239
Exhaust Gas . . . . .	240
Carbon Monoxide Warnings . . . . .	240

## IN CASE OF EMERGENCY

<b>HAZARD WARNING FLASHERS</b> . . . . .	<b>241</b>
<b>SOS AND ASSIST MIRROR — IF EQUIPPED</b> . . . . .	<b>241</b>
<b>JACKING AND TIRE CHANGING — IF EQUIPPED</b> . . . . .	<b>244</b>
Preparations For Jacking . . . . .	244
Jack And Spare Tire Location . . . . .	244
Equipment Removal . . . . .	244
Jacking Instructions . . . . .	245
Road Tire Installation . . . . .	248
Portable Air Compressor — If Equipped . . . . .	249
Return Inflatable Spare Tire . . . . .	250
<b>TIRE SERVICE KIT — IF EQUIPPED</b> . . . . .	<b>250</b>
<b>JUMP STARTING — GAS MODELS</b> . . . . .	<b>254</b>
Preparations For Jump Start — Gas Models . . . . .	255
Jump Starting Procedure — Gas Models . . . . .	255
<b>JUMP STARTING — HYBRID MODELS</b> . . . . .	<b>256</b>
Preparations For Jump Start — Hybrid Models . . . . .	257
Jump Starting Procedure — Hybrid Models . . . . .	258
<b>REFUELING IN EMERGENCY — IF EQUIPPED</b> . . . . .	<b>258</b>
<b>IF YOUR ENGINE OVERHEATS</b> . . . . .	<b>259</b>
<b>MANUAL PARK RELEASE</b> . . . . .	<b>260</b>
<b>FREEDING A STUCK VEHICLE</b> . . . . .	<b>261</b>
<b>TOWING A DISABLED VEHICLE</b> . . . . .	<b>261</b>
All Wheel Drive (AWD) Models . . . . .	263
<b>ENHANCED ACCIDENT RESPONSE SYSTEM (EARS)</b> . . . . .	<b>263</b>
<b>EVENT DATA RECORDER (EDR)</b> . . . . .	<b>263</b>

## SERVICING AND MAINTENANCE

<b>SCHEDULED SERVICING</b> . . . . .	<b>264</b>
Maintenance Plan . . . . .	264
<b>ENGINE COMPARTMENT</b> . . . . .	<b>266</b>
3.6L Engine . . . . .	266
ENGINE COMPARTMENT — HYBRID MODELS (IF EQUIPPED) . . . . .	267
Checking Oil Level . . . . .	268
Adding Washer Fluid . . . . .	268
Maintenance-Free Battery . . . . .	268
Pressure Washing . . . . .	269
<b>VEHICLE MAINTENANCE</b> . . . . .	<b>269</b>
Engine Oil . . . . .	269
Engine Oil Filter . . . . .	270
Engine Air Cleaner Filter . . . . .	270
Accessory Drive Belt Inspection . . . . .	270
Air Conditioner Maintenance . . . . .	271
Body Lubrication . . . . .	272
Windshield Wiper Blades . . . . .	273
Exhaust System . . . . .	275
Cooling System . . . . .	276
Cooling System — Hybrid Models (If Equipped) . . . . .	278
Brake System . . . . .	281
Automatic Transmission . . . . .	281
Fuses . . . . .	282
Bulb Replacement . . . . .	289
<b>TIRES</b> . . . . .	<b>291</b>
Tire Safety Information . . . . .	291
Tires — General Information . . . . .	297
Tire Types . . . . .	300
Spare Tires — If Equipped . . . . .	300
Wheel And Wheel Trim Care . . . . .	301

Snow Traction Devices . . . . .	302
Tire Rotation Recommendations . . . . .	304

### DEPARTMENT OF TRANSPORTATION UNIFORM

<b>TIRE QUALITY GRADES</b> . . . . .	<b>304</b>
Treadwear . . . . .	304
Traction Grades . . . . .	304
Temperature Grades . . . . .	305

### STORING THE VEHICLE . . . . . 305

#### STORING THE VEHICLE — HYBRID MODELS

##### (IF EQUIPPED) . . . . . 305

<b>BODYWORK</b> . . . . .	<b>306</b>
Protection From Atmospheric Agents . . . . .	306
Body And Underbody Maintenance . . . . .	306
Preserving The Bodywork . . . . .	306

<b>INTERIORS</b> . . . . .	<b>307</b>
Seats And Fabric Parts . . . . .	307
Plastic And Coated Parts . . . . .	307
Leather Surfaces . . . . .	308
Glass Surfaces . . . . .	308

## TECHNICAL SPECIFICATIONS

### VEHICLE IDENTIFICATION NUMBER (VIN) . . . . . 309

### BRAKE SYSTEM . . . . . 309

<b>WHEEL AND TIRE TORQUE SPECIFICATIONS</b> . . . . .	<b>309</b>
Torque Specifications . . . . .	309

### FUEL REQUIREMENTS . . . . . 310

3.6L Engine . . . . .	310
Reformulated Gasoline . . . . .	310
Gasoline/Oxygenate Blends . . . . .	310
Do Not Use E-85 In Non-Flex Fuel Vehicles . . . . .	311
CNG And LP Fuel System Modifications . . . . .	311
Methylcyclopentadienyl Manganese Tricarbonyl (MMT) In Gasoline . . . . .	311

Materials Added To Fuel . . . . .	311
Fuel System Cautions . . . . .	311

### FLUID CAPACITIES . . . . . 312

#### FLUID CAPACITIES — HYBRID . . . . . 312

#### ENGINE FLUIDS AND LUBRICANTS . . . . . 313

#### ENGINE FLUIDS AND LUBRICANTS — HYBRID . . . . . 313

#### CHASSIS FLUIDS AND LUBRICANTS . . . . . 314

#### CHASSIS FLUIDS AND LUBRICANTS — HYBRID . . . . . 314

## CUSTOMER ASSISTANCE

### SUGGESTIONS FOR OBTAINING SERVICE

<b>FOR YOUR VEHICLE</b> . . . . .	<b>315</b>
Prepare For The Appointment . . . . .	315
Prepare A List . . . . .	315
Be Reasonable With Requests . . . . .	315

### IF YOU NEED ASSISTANCE . . . . . 315

Roadside Assistance . . . . .	315
FCA US LLC Customer Center . . . . .	316
FCA Canada Customer Care . . . . .	316
Mexico . . . . .	316
Puerto Rico And US Virgin Islands . . . . .	316
Customer Assistance For The Hearing Or Speech Impaired (TDD/TTY) . . . . .	316
Service Contract . . . . .	317

### WARRANTY INFORMATION . . . . . 317

### MOPAR® PARTS . . . . . 317

### REPORTING SAFETY DEFECTS . . . . . 317

In The 50 United States And Washington, D.C. . . . .	317
In Canada . . . . .	318

### PUBLICATION ORDER FORMS . . . . . 318

### Change Of Ownership Or Address . . . . . 318

### GENERAL INFORMATION . . . . . 318



---

# INTRODUCTION

Dear Customer,



Congratulations on the purchase of your new Chrysler vehicle. Be assured that it represents precision workmanship, distinctive styling, and high quality.

This Owner's Manual has been prepared with the assistance of service and engineering specialists to acquaint you with the operation and maintenance of your vehicle. It is supplemented by customer-oriented documents. Within this information, you will find a description of the services that FCA US LLC offers to its customers as well as the details of the terms and conditions for maintaining its validity. Please take the time to read all of these publications carefully before driving your vehicle for the first time. Following the instructions, recommendations, tips, and important warnings in this manual will help ensure safe and enjoyable operation of your vehicle.

This Owner's Manual describes all versions of this vehicle. Options and equipment dedicated to specific markets or versions are not expressly indicated in the text. Therefore, you should only consider the information that is related to the trim level, engine, and version that you have purchased. Any content introduced throughout the Owner's Information, which may or may not be applicable to your vehicle, will be identified with the wording "If Equipped". All data contained in this publication are intended to help you use your vehicle in the best possible way. FCA US LLC aims at a constant improvement of the vehicles produced. For this reason, it reserves the right to make changes to the model described for technical and/or commercial reasons. For further information, contact an authorized dealer.

When it comes to service, remember that authorized dealers know your Chrysler vehicle best, have factory-trained technicians, genuine Mopar® parts, and care about your satisfaction.

## SYMBOLS KEY

<b>WARNING!</b>	These statements apply to operating procedures that could result in a collision, bodily injury and/or death.
<b>CAUTION!</b>	These statements apply to procedures that could result in damage to your vehicle.
<b>NOTE:</b>	A suggestion which will improve installation, operation, and reliability. If not followed, may result in damage.
<b>TIP:</b>	General ideas/solutions/suggestions on easier use of the product or functionality.
<b>PAGE REFERENCE ARROW</b> 	Follow this reference for additional information on a particular feature.
<b>FOOTNOTE</b> 	Supplementary and relevant information pertaining to the topic.

If you do not read the entire Owner's Manual, you may miss important information. Observe all Cautions and Warnings.

## VEHICLE MODIFICATIONS/ALTERATIONS

### WARNING!



Any modifications or alterations to this vehicle could seriously affect its roadworthiness and safety and may lead to a collision resulting in serious injury or death.







## SYMBOL GLOSSARY







Some car components have colored labels with symbols indicating precautions to be observed when using this component. It is important to follow all warnings when operating your vehicle. See below for the definition of each symbol → page 111.



### NOTE:





Warning and Indicator lights are different based upon equipment options and current vehicle status. Some telltales are optional and may not appear.







Red Warning Lights	
	Air Bag Warning Light → page 111
	Battery Charge Warning Light → page 111
	Brake Warning Light → page 111





Red Warning Lights	
	Door Open Warning Light ⇨ page 111
	Electric Power Steering Fault Warning Light ⇨ page 112
	Electronic Throttle Control (ETC) Warning Light ⇨ page 112
	Engine Coolant Temperature Warning Light ⇨ page 112
	Hood Open Warning Light ⇨ page 112
	Liftgate Open Warning Light ⇨ page 112

Red Warning Lights	
	Oil Pressure Warning Light ⇨ page 112
	Oil Temperature Warning Light ⇨ page 112
	Seat Belt Reminder Warning Light ⇨ page 113
	Transmission Temperature Warning Light ⇨ page 113
	Vehicle Security Warning Light ⇨ page 113
	Hybrid Electric Vehicle System Service Warning Light ⇨ page 113







Red Warning Lights	
	Plug Status Fault Warning Light ↔ page 113
	Torque Limited Warning Light ↔ page 113





Yellow Warning Lights	
	Adaptive Cruise Control (ACC) Fault Warning Light ↔ page 114
	Electric Park Brake Warning Light ↔ page 114
	Anti-Lock Brake System (ABS) Warning Light ↔ page 113
	Electronic Stability Control (ESC) Active Warning Light ↔ page 114

Yellow Warning Lights	
	Electronic Stability Control (ESC) OFF Warning Light ↔ page 114
	Engine Check/Malfunction Indicator Warning Light ↔ page 114
	Fuel Level Sensor Fail Warning Light ↔ page 115
	LaneSense Warning Light ↔ page 114
	Low Fuel Warning Light ↔ page 114
	Low Washer Fluid Warning Light ↔ page 115



Yellow Warning Lights	
	Service AWD Warning Light ⇨ page 115
	Service Forward Collision Warning (FCW) or Pedestrian Emergency Braking (PEB) Warning Light ⇨ page 115
	Service LaneSense Warning Light ⇨ page 115
	Service Stop/Start System Warning Light ⇨ page 115
	Tire Pressure Monitoring System (TPMS) Warning Light ⇨ page 115

Yellow Indicator Lights	
	Forward Collision Warning (FCW) or Pedestrian Emergency Braking (PEB) OFF Indicator Light ⇨ page 116

Green Indicator Lights	
	Adaptive Cruise Control (ACC) Set With Target Vehicle Detected Indicator Light ⇨ page 116
	Adaptive Cruise Control (ACC) Set With No Target Detected Indicator Light ⇨ page 116
	Cruise Control Set Indicator Light ⇨ page 116
	Front Fog Indicator Light ⇨ page 116
	LaneSense Indicator Light ⇨ page 116
	Stop/Start Active Indicator Light ⇨ page 116

Green Indicator Lights	
	Parking/Headlights On Indicator Light ↔ page 116
	Turn Signal Indicator Lights ↔ page 116
	Max Regeneration Indicator Light ↔ page 117
	Ready To Drive Indicator Light ↔ page 117
	Plug Status Indicator Light ↔ page 117

White Indicator Lights	
	Adaptive Cruise Control (ACC) Ready Light ↔ page 117

White Indicator Lights	
	Cruise Control Ready Indicator Light ↔ page 117
	LaneSense Indicator Light ↔ page 117
	Set Speed Display Indicator Light ↔ page 117

Blue Indicator Lights	
	High Beam Indicator Light ↔ page 117

# GETTING TO KNOW YOUR VEHICLE

## HIGH VOLTAGE BATTERY

Your vehicle is equipped with a Lithium-ion high voltage battery that is used to power the electric powertrain systems and the 12 Volt vehicle electrical system.

The high voltage battery is located under the middle section of the vehicle, below and in front of the second row seating. The high voltage battery is maintenance free and designed to last for the life of the vehicle.

Lithium-ion batteries provide the following benefits:

- Lithium-ion batteries are much lighter than other types of rechargeable batteries of the same size.
- Lithium-ion batteries hold their charge; they only lose approximately three percent of their charge per month.
- Lithium-ion batteries have no memory, which means that you do not have to completely discharge them before recharging, as with some other batteries.
- Lithium-ion batteries can be recharged and discharged thousands of times.

### High Voltage Battery Service Disconnect

The high voltage battery service disconnect is located under the access panel, in front of the second row passenger seating. Only a qualified service technician should access the high voltage battery service disconnect.

If your vehicle requires high voltage battery service, see an authorized dealer.

### WARNING!

- Never try to remove the high voltage battery service disconnect. The high voltage battery service disconnect is used when your vehicle requires service by a qualified technician at an authorized dealership. Failure to follow this warning can result in electrical shock, toxic emissions, fire, and other hazards which can cause death or serious injury including severe burns, respiratory injuries, and blindness.
- The high voltage battery and battery case have no parts that you or an unqualified technician can service. Under no circumstances should you or an unqualified technician open, disassemble, penetrate, or tamper with the high voltage battery, battery case, their cables, or connectors. Damage to these components can result in electrical shock, toxic emissions, fire, and other hazards which can cause death or serious injury including severe burns, respiratory injuries, and blindness. You should take the vehicle to an authorized dealership for any service or maintenance on these high voltage components.
- The high voltage system can be hot during and after starting, and when the vehicle is shut off or charging. Be careful of both the high voltage and the high temperature. Failure to do so can result in severe burns.

### Disposal of the High Voltage Battery

Your vehicle's high voltage battery is designed to last the life of your vehicle. See an authorized dealer for information on the disposal of the battery if it should require replacement.

### WARNING!

Your vehicle contains a sealed Lithium-ion high voltage battery. If the battery is disposed of improperly, there is a risk of electrical shock and toxic emissions which can cause severe burns, respiratory injuries, fires, and other hazards resulting in serious injury or death.

### General Information

The vehicle is also equipped with a Battery Management system that is designed to:

- Ensure safe operation
- Maximize driving range
- Maximize the life expectancy of the high voltage battery

**NOTE:**

- During vehicle start up and shut down, a clicking noise may be heard from within the vehicle. When the ignition is in the ON/RUN position, the high voltage battery contactors inside the battery are closed to make the stored electricity inside available for vehicle use. After the vehicle is shut down, the contactors open to electrically isolate the battery from other vehicle systems. The clicking noise is the sound of these contactors as they open and close during normal operation.
- The Audible Pedestrian Warning system will emit a noise from the front of the vehicle when driving forward at speeds below 22 mph (35 km/h). It will also emit a noise from the rear of the vehicle when in REVERSE, and from both the front and rear of the vehicle when in NEUTRAL. For more information on this system, see  page 195.

**WARNING!**

In the event of a collision:

- If your vehicle is still drivable, pull off to the side of the road, when safe to do so, and place the transmission in the PARK position, apply the parking brake, and turn the vehicle off.
- Beware of any exposed high-voltage parts or cables. To avoid electrical shock which can result in serious injury or death, never touch wiring, connectors, and other high-voltage parts, such as the inverter unit and the Lithium-ion battery.
- Leaks or damage to the Lithium-ion battery may result in a fire and toxic emissions which can cause severe burns, respiratory injuries, and other serious injuries or death. If you discover these leaks, contact emergency services immediately.

*(Continued)*

**WARNING!**

Since the fluid leak may be Lithium Manganate from the Lithium-ion battery, never touch the fluid leak inside or outside of the vehicle. If the fluid contacts your skin or eyes, wash these areas immediately with a large amount of water and obtain immediate medical attention to help avoid serious injury.

- If a fire occurs inside your vehicle, leave the vehicle as soon as possible. Only use a type ABC, BC, or C fire extinguisher that is meant for use on electrical fires. Using a small amount of water, or the incorrect fire extinguisher can result in serious injury or death from electrical shock.
- If you are not able to safely assess the vehicle due to vehicle damage, do not touch the vehicle. Leave the vehicle and contact emergency services. Advise first responders that this is a electric vehicle.
- In the event of an accident that requires bodywork, refer to an authorized dealership.

**BATTERY CONDITIONING**

In extreme temperatures, high or low, the high voltage battery may need to be conditioned, and therefore may require the vehicle to be plugged in.

If the ambient temperature is 5 °F (-15 °C) or below at vehicle shut down, the instrument cluster will display the message “Plug In Vehicle For Battery Conditioning”.

If the battery temperature is below -22 °F (-30 °C), or 131 °F (55 °C) or above, the vehicle will NOT start:

- If the vehicle is plugged in at these battery temperatures, the instrument cluster will display the message “Please Leave Key In RUN — Battery Conditioning Needed”.
- If the vehicle is not plugged in at these battery temperatures, the “Plug In Vehicle To Condition Battery” will be shown in the instrument cluster display.
- If the battery temperature is below -27 °F (-33 °C), the message “Please Leave Key In RUN — Battery Conditioning Needed” will be displayed whether the vehicle is plugged in or not.

**NOTE:**

- When the “Please Leave Key In RUN — Battery Conditioning Needed” message is displayed, keep the ignition in the RUN position for the battery to recover. Place the ignition back in the OFF position when the message disappears, and then start the vehicle. When this message is displayed, do not operate any air conditioning controls.
- Under these high or low temperatures, if the vehicle is plugged in, and the ignition is in the OFF position, the vehicle may “wake up” to precondition the high voltage battery for use.
- It is recommended that the vehicle be plugged in overnight when possible to maximize the electric range of the vehicle.

The messages will only be displayed when the ignition is in the ON/RUN position and the high voltage battery is not ready to provide propulsion power. The message also displays if there is a failed attempt to achieve READY state when the high voltage battery cell temperatures are either too cold or too hot.



## HIGH VOLTAGE CHARGING OPERATION

### SAE J1772 CHARGING INLET

Your vehicle uses an industry standard SAE J1772 charge inlet (vehicle charge inlet) for both AC Level 1 (120 V), and AC Level 2 (240 V) charging.

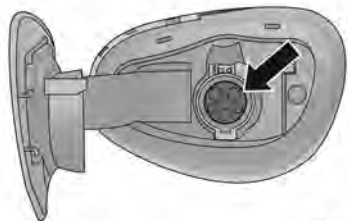

A0202000038US

Vehicle Charge Inlet

Open the charge port door by pushing near the rear outer edge of the door, near the center to unlatch. To close the charge port door, engage the door latch by pushing on the rear outer edge near the center.

### AC LEVEL 1 CHARGING (120 VOLT, 12 AMP)

Your vehicle may be equipped with a 120 Volt AC, SAE J1772 Level 1 Electric Vehicle Supply Equipment (EVSE), also referred to as a Portable Charging Cordset (EVSE). AC Level 1 charging requires a conventional NEMA 5-15R 120 Volt AC grounded wall outlet along with the Portable Charging Cordset (EVSE) provided with the vehicle.

#### WARNING!

Please be sure to follow these warnings. Failure to do so may result in serious injury or death.

- Discontinue use of the Portable Charging Cordset (EVSE) immediately if the plug or outlet becomes hot to the touch or if you notice any unusual odors.
- Do not use the Portable Charging Cordset (EVSE) in building structures that use fuse-based circuit protection. Use only with electrical circuits protected by circuit breakers.
- Do not use the Portable Charging Cordset (EVSE) if other devices are plugged into the same circuit.
- When unplugging the Portable Charging Cordset (EVSE) from the wall outlet, be sure to pull by the plug, and not the cord.
- Do not pull, twist, bend, step on or drag the cord of the Portable Charging Cordset (EVSE).
- Stop using the Portable Charging Cordset (EVSE) immediately if charging stops before it's completed when the plug or cord is moved or adjusted.
- Do not use the Portable Charging Cordset (EVSE) if the plug has a loose connection with the wall outlet or if the wall outlet is damaged or rusted.
- If in any doubt about the wall outlet and/or circuit, contact a qualified electrician.
- Do not use if a malfunction occurs or if the Portable Charging Cordset has been damaged in any manner. It is recommended that you contact an authorized dealership.
- There are no user serviceable parts inside the Portable Charging Cordset (EVSE). Do not attempt to repair or service the Portable Charging Cordset (EVSE), doing so will void the New Vehicle Warranty.



A0202000008US

Portable Charging Cordset (EVSE)

#### WARNING!

**INSTRUCTIONS PERTAINING TO A RISK OF FIRE OR ELECTRIC SHOCK:** Electrical shock, fire, and other serious hazards can occur if the Portable Charging Cordset (EVSE) is not used properly. This vehicle uses a high voltage current. Failure to follow the proper charging instructions in this publication can cause serious injury or death. There are no serviceable parts in the Portable Charging Cordset (EVSE). Do not open, disassemble, penetrate, or tamper with the Portable Charging Cordset (EVSE). Failure to follow this warning can result in electrical shock, fire, property damage, and death or serious injury.

To access the Portable Charging Cordset (EVSE), open the door of the cargo area storage bin if equipped, on the driver's side, and remove the Portable Charging Cordset (EVSE) from the storage bag.

**NOTE:**

After use, the Portable Charging Cordset (EVSE) should be placed in the storage bag and put back in the cargo area storage bin if equipped. If the Portable Charging Cordset (EVSE) will be left outside the vehicle, be sure to protect the connection end from moisture, dirt, and debris accumulation and contamination.

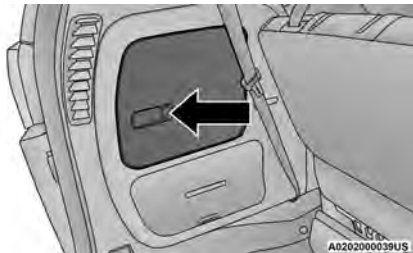

**Cargo Area Storage Bin**

**NOTE:**

The Portable Charging Cordset (EVSE) is used for AC Level 1 charging only.

**WARNING!**

**IMPORTANT SAFETY INSTRUCTIONS PERTAINING TO A RISK OF FIRE OR ELECTRIC SHOCK:** This publication contains important instructions and warnings that should be followed during charging operations. Failure to follow these warnings and instructions can result in electrical shock and fire which can cause death or serious injury.

- Read this entire publication before using the Portable Charging Cordset (EVSE).

*(Continued)*

**WARNING!**

- Do not put fingers or objects into the Portable Charging Cordset (EVSE) connector.
- Do not use the Portable Charging Cordset (EVSE) if the flexible power cord is frayed, broken, has cracked insulation, or any other signs of damage.
- Do not use the Portable Charging Cordset (EVSE) if the enclosure or the connector is broken, cracked, open, or shows any other indication of damage.
- Do not use the Portable Charging Cordset (EVSE) with an extension cord or plug adapters.
- The Portable Charging Cordset (EVSE) may attempt to reset and run after a power interruption.
- There are no user serviceable parts inside the Portable Charging Cordset (EVSE). Do not attempt to repair or service the Portable Charging Cordset (EVSE) yourself – personal injury may result.
- When using a charging station with the Portable Charging Cordset (EVSE) attached, ensure the charging station's cable is not visibly damaged before plugging into the vehicle.
- Do not allow children to operate the Portable Charging Cordset (EVSE). Adult supervision is mandatory when children are in proximity to the charge station that is in use.
- Do not use a charge station or vehicle charge inlet that is worn or damaged with the AC Level 2 charging cable. Plugging into worn or damaged receptacles may cause damage to the Portable Charging Cordset (EVSE) and vehicle.

*(Continued)*

**WARNING!**

- Ensure that the Portable Charging Cordset (EVSE) is always stored in a safe place. Do not expose the EVSE J1772 vehicle connector to rain or wet conditions. Avoid allowing water or other liquids to pour or drip onto the vehicle connection end of the J1772 EVSE connector. If water penetrates the electrical device, the risk of electrical shock increases. Ensure that all plugs and cables are free of moisture before using the Portable Charging Cordset (EVSE).
- In a collision, a loose Portable Charging Cordset (EVSE) in the vehicle could cause injury. It could fly around in a sudden stop and strike someone in the vehicle. Do not store the Portable Charging Cordset (EVSE) on the cargo load floor, or in the passenger compartment.
- The Portable Charging Cordset (EVSE) has been tested for use in temperatures ranging from -40° F to 122° F (-40° C to 50° C).
- The Portable Charging Cordset (EVSE) should be stored at temperatures between -40° F and 176° F (-40° C and 80° C).
- **SAVE THESE INSTRUCTIONS.**

## AC LEVEL 2 CHARGING (240 VOLT, 32 AMP)

AC Level 2 (240 V) charging requires a 240 V, Level 2 Electric Vehicle Supply Equipment (EVSE) charging station. A 32 Amp Level 2 EVSE for home installation is recommended. The Level 2 EVSE connects to a 40 Amp circuit breaker and delivers 32 Amp maximum to the vehicle.

When using public charging stations, ensure the charging station is ready to provide charge and the vehicle is in PARK before the Level 2 EVSE is plugged into the vehicle's charge inlet. You will hear a "click" when the charge connector is inserted correctly and is coupled with the vehicle's charge inlet.

#### NOTE:

The vehicle should start charging automatically. If not, please check the following:

- **Charging Station** — Check the indications and instructions at the charging station.
- **Charging Schedule** — Check whether the charging schedule is enabled and if so, whether the vehicle is currently within the scheduled charge time/day (weekday/weekend). If the charging schedule is enabled within the vehicle, you may override it for this charging event by plugging in the charge connector, unplugging it, and then plugging it back into the vehicle charge inlet. Complete the double plug sequence within 10 seconds for it to override the set schedule.
- **Hood Ajar** — Check whether the hood is open. Charging is disabled while the hood is open, and will resume when the hood closes.

To stop the charging process:

- Press the button located on the Level 2 EVSE vehicle connector.
- Remove the connector from the vehicle charge inlet.
- Plug the charge handle into the Level 2 EVSE station and coil the charging cord onto its holder. Do not leave the charging cord lying on the ground.

## VEHICLE CHARGE INDICATORS

### Instrument Cluster High Voltage Battery Display

There is a battery display indicator located on the instrument cluster. The battery display will indicate the current State Of Charge (SOC) for the high voltage battery; with the percentage value located to the right of the symbol. When plugged in, the battery symbol also indicates the battery level along with messages about the charge or whether the system is waiting to charge due to the charge schedule. These will appear unless there is a charging fault. A green plug telltale will be shown in the cluster, as well as applicable messaging when charging.

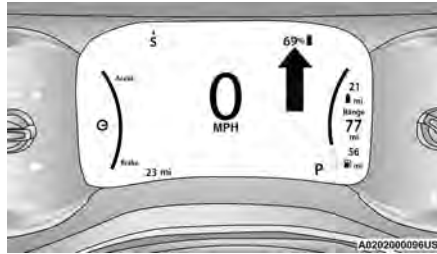

**High Voltage Battery Display**

### Instrument Panel State Of Charge Indicator

In addition to the battery display in the instrument cluster, your vehicle is equipped with a visual SOC indicator. The SOC indicator is made up of five lights that are mounted to the top center of the instrument panel, which will illuminate when the vehicle is plugged into the charging system.

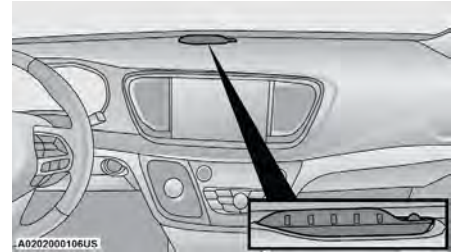

**State Of Charge Indicator**

The SOC indicator provides a visual indication of the high voltage battery's charge status during charging. It is also used to indicate a charging problem as well as waiting for a scheduled charge to begin.

#### NOTE:

The lights scroll one at a time when the vehicle is plugged in outside of its charging schedule time/day of the week, and it is waiting on the schedule to begin charging.

In extreme hot or cold environments, the lights on the SOC indicator may not illuminate. Charge status is available in the instrument cluster display. In the event of an error in the charging process, the outer two lights will blink.

When the hood is open, the lights on the SOC indicator will not be illuminated.

Number Of Indicator Lights Illuminated	Percent Of Battery Charge
1st light blinks	0 – 20%
1st light on, 2nd light blinks	21 – 40%
1st and 2nd lights on, 3rd light blinks	41 – 60%
1st, 2nd, and 3rd lights on, 4th light blinks	61 – 80%
1st, 2nd, 3rd, and 4th lights on, 5th light blinks	81 – 99%
All 5 lights on	100%
Two outer lights are blinking	Indicates an error in the charging process
Lights turn on one at a time from left to right (when looking at the front of the vehicle)	Indicates system is waiting for scheduled time in charge schedule to begin charging
All lights turn on, then immediately turn off	Indicates a successful plug-in

**NOTE:**

For each segment of lights illuminated indicating the percent of battery charge, two different blink rates are used. A blink rate of 1 second on/1 second off indicates that the first half is charging. The blink rate will increase to 0.5 second on/0.5 second off to indicate that the second half is charging. When the battery is fully charged, the blinking stops and the lights remain illuminated as charging continues.

## HYBRID ELECTRIC APP

Within the Uconnect system is the Hybrid Electric App that allows you to see your vehicle's power flow, understand your driving history, and set a charging schedule for your vehicle's high voltage battery. To access this App, press the Apps or Vehicle button on the main menu bar of the radio's touchscreen, and locate the Hybrid Electric App. Accessing the app brings you to a set of three pages: Power Flow, Driving History, and Schedules.

**Hybrid Electric App Location**

## Power Flow

The Power Flow screen shows the current power readings for all of the following:

- **Engine** - Shows the amount of power (in kW) the engine is generating. Based on vehicle operating conditions, this power is used to: propel the vehicle, provide passenger compartment heating, power vehicle electrical loads, and charge the high voltage battery. Engine operation is controlled to maximize fuel economy.

- **Battery** - Shows the amount of power (in kW) the high voltage battery is currently providing/absorbing. A negative kW indicates the vehicle's high voltage battery is charging.
- **Climate** - Shows the amount of power (in kW) the Climate Control system is using to maintain the current interior temperature.

Power Flow paths are indicated by the direction of the arrows on the touchscreen.

**Power Flow Screen**

## Driving History

The Driving History screen shows the miles (km) driven in both Full Electric and Hybrid (battery and engine powered) modes for both the previous week and the current week. The data is displayed in a bar graph: Electric mode in teal and Hybrid mode in blue.

On the bar graph, miles (km) driven on the same day in Electric mode (battery only) are always shown below miles (km) driven in Hybrid mode. When one day of the week exceeds 100 miles (160 km) driven, the values for miles (km) driven in Electric and Hybrid modes will be listed above the bar graph in respective colors (teal for Electric and blue for Hybrid).



Driving History Screen

## Charging Schedule

To set a charging schedule, select the Hybrid Electric App in the touchscreen and follow these steps:

1. Select "Schedules".



Schedules Screen

2. Select the schedule to be set (1, 2, or 3) by pressing the appropriate arrow on the right side of the screen.
3. Select "Charge Schedule".



Select Charge Schedule

4. Select if Scheduled Charging should "Charge Until Full".
5. Set the Charge Start Time: Hours, Minutes, and AM/PM.

### NOTE:

This is to occur every week (as long as the vehicle is connected to an EVSE).



Set Charge Schedule

6. When done, press the X in the upper right hand corner, then select "yes" to save the charge schedule. The active schedule will be indicated by the check mark to the right of the schedule event line. The event action and time will be displayed.
7. To add another Scheduled Charging event, repeat these steps.

### NOTE:

A maximum of three independent Scheduled Charging events can be scheduled at a given time.

### NOTE:

- If the charging schedule is not enabled, the vehicle will charge whenever plugged in. It is not necessary to set up the charging schedule to charge the vehicle.
- If the vehicle is plugged in outside of the charging schedule set in the Uconnect system (and Charge Until Full is not selected), the vehicle's battery will not charge. Charging will only begin immediately if the vehicle is plugged in within the time and day of

the week set in the schedule. Otherwise, charging will automatically begin when the selected charge time/day of the week occurs or whenever the vehicle is plugged in with no charge schedule set.

- If the vehicle is turned off outside of the charging window, a radio pop-up message will be displayed, which provides an option to begin charging the vehicle immediately. The pop-up message asks the driver if they would like to “Charge Now?” and provides other information, including the next charging schedule start time and estimated time to charge the battery to 100%. If within one hour of selecting “Yes,” the vehicle is connected to a powered EVSE, the vehicle will immediately begin to charge (temporarily ignoring any set charge schedule). To fully deactivate the charge schedule, refer to the “Schedules” feature within the Hybrid Electric App.
- The charging schedule can also be overridden if an EVSE is plugged in, unplugged, and then plugged in a second time to the vehicle. This “double plug sequence” will override the schedule that is set in the radio, and begin charging the vehicle immediately. The double plug sequence must be completed within 10 seconds for it to override the programmed schedule.
- If “Charge Until Full” is selected, and the vehicle is plugged in after the start time of the schedule, the vehicle will start charging when it reaches the start time the next day. If you would like to begin charging immediately, and continue charging until the vehicle is fully charged, you can select the “Charge Now” option or use the double plug override option.

#### NOTE:

For information on jump starting your vehicle,  page 256.

## KEYS

### KEY FOB

Your vehicle is equipped with a key fob which supports Passive Entry, Remote Keyless Entry (RKE), Keyless Enter ‘n Go™ (if equipped), Remote Start (if equipped), and remote power liftgate operation. The key fob allows you to lock or unlock the doors and liftgate, optional power liftgate, left power sliding door, and right power sliding door, from distances up to approximately 66 ft (20 m). When any button on the key fob is pushed, or when any signal is being transferred between the key fob and the vehicle, an LED light on the key fob will flash as an indicator. The key fob does not need to be pointed at the vehicle to activate the system. The key fob also contains an emergency key, which is stored in the rear of the key fob.

The emergency key allows for entry into the vehicle should the battery in the vehicle or the key fob become depleted. The emergency key is also for locking/unlocking the glove compartment. You can keep the emergency key with you when valet parking.

#### NOTE:

- The key fob’s wireless signal may be blocked if the key fob is located next to a mobile phone, laptop, or other electronic device. This may result in poor performance.
- If your vehicle is equipped with a Wireless Charging Pad, the key fob may not be detected if it is placed within 6 inches (15 cm) of the pad  page 83.
- With the ignition in the ON position and the vehicle moving at 2 mph (4 km/h), all RKE commands are disabled.



Key Fob

- 1 — LED Light
- 2 — Unlock
- 3 — Liftgate
- 4 — Left Power Sliding Side Door
- 5 — Emergency Key
- 6 — Lock
- 7 — Remote Start
- 8 — Right Power Sliding Side Door
- 9 — Panic Alarm

In case the ignition switch does not change with the push of a button, the key fob may have a low or fully depleted battery. A low key fob battery can be verified by referring to the instrument cluster, which will display directions to follow.

**NOTE:**

- A low key fob battery condition may be indicated by a message in the instrument cluster display, or by the LED light on the key fob. If the LED key fob light no longer illuminates from key fob button pushes, then the key fob battery requires replacement.
- The key fob LED light brightness is designed for indoor light viewing, so the LED light may not be visible in direct sunlight ↪ page 318.

**To Lock/Unlock The Doors And Liftgate**

Push and release the unlock button on the key fob once to unlock the driver's front door and sliding door or twice within five seconds to unlock all doors and the liftgate. Push and release the lock button on the key fob to lock all doors and the liftgate.

When the doors are unlocked, the turn signals will flash and the illuminated entry system will be activated. When the doors are locked, the turn signals will flash and the horn will chirp. Settings in the Uconnect system can change to lights only, chirp only, or both.

**Vehicles Equipped With Keyless Enter 'n Go™ — Passive Entry**

If one or more doors are open, or the liftgate is open, the doors can be locked. The doors will unlock again only if the key fob is inside the passenger compartment.

All doors can be programmed to unlock on the first push of the unlock button within Uconnect Settings ↪ page 169.

**Key Left Vehicle Feature**

If a valid key fob is no longer detected inside the vehicle while the vehicle's ignition system is in the ON/RUN or START position, the message "Key Fob Has Left The Vehicle" will be shown in the instrument cluster display along with an interior chime. An exterior audible and visual alert will also be activated to warn the driver.

The vehicle's horn will rapidly chirp three times along with a single flash of the vehicle's exterior lights.

**NOTE:**

- The doors have to be open and then closed in order for the vehicle to detect a key fob. The Key Left Vehicle feature will activate when the first door is closed and no key fob is detected in the vehicle. If the warning has been activated, and the other doors are closed, no other warnings will be issued.
- These alerts will not be activated in situations where either the vehicle's engine is left running with the key fob inside, or the key fob's wireless signals are blocked.

**Replacing The Battery In The Key Fob**

The recommended replacement battery is one CR2032 battery.

**NOTE:**

- Customers are recommended to use a battery obtained from Mopar®. Aftermarket coin battery dimensions may not meet the original OEM coin battery dimensions.
- Batteries contain harmful chemicals. Dispose old batteries by placing them in correct containers according to the law or by taking them to a dealership, where they will be handled appropriately.

- Perchlorate Material — special handling may apply. See [www.dtsc.ca.gov/hazardouswaste/perchlorate](http://www.dtsc.ca.gov/hazardouswaste/perchlorate) for further information.

- Do not touch the battery terminals that are on the back housing or the printed circuit board.
1. Remove the emergency key by pushing the mechanical release button on the side of the key fob with your thumb and then pulling the key out with your other hand.

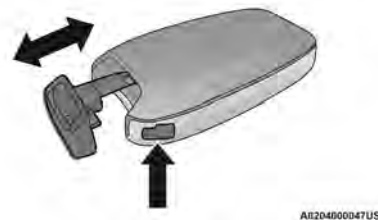
**Emergency Key Removal**

2. Insert a coin or a flat-blade screwdriver into the now exposed slot and carefully pry on both sides to disengage the snaps. Gently remove the back cover from the fob, being careful not to damage any of the snaps.
3. Remove the battery by sliding the battery rearward in its pocket until the battery lifts up. Remove the depleted battery from the battery pocket and dispose appropriately.

4. Fit a new battery ensuring that the positive (+) side is facing upwards. Push the battery into the pocket until it is firmly seated in place and secured under both tabs.
5. Align the back cover into its original position and snap it back in place by pushing it against the fob until it is seated all around.

**WARNING!**

- The integrated key fob contains a coin cell battery. Do not ingest the battery; there is a chemical burn hazard. If the coin cell battery is swallowed, it can cause severe internal burns in just two hours and can lead to death.
- If you think a battery may have been swallowed or placed inside any part of the body, seek immediate medical attention.
- Keep new and used batteries away from children. If the battery compartment does not close securely, stop using the product and keep it away from children.

## Programming And Requesting Additional Key Fobs

Programming the key fob may be performed by an authorized dealer.

**NOTE:**

- Once a key fob is programmed to a vehicle, it cannot be repurposed and reprogrammed to another vehicle.
- Only key fobs that are programmed to the vehicle electronics can be used to start and operate the vehicle.

**WARNING!**

- Always remove the key fobs from the vehicle and lock all doors when leaving the vehicle unattended.
- For vehicles equipped with Keyless Enter 'n Go™ Ignition, always remember to place the ignition in the OFF position when exiting the vehicle.

Duplication of key fobs may be performed at an authorized dealer. This procedure consists of programming a blank key fob to the vehicle electronics. A blank key fob is one that has never been programmed.

**NOTE:**

- When having the Sentry Key Immobilizer system serviced, bring all vehicle keys with you to an authorized dealer.
- Emergency keys must be ordered to the correct key cut to match the vehicle locks.
- It is not mandatory to replace the key fob if a new emergency key is needed, and vice versa.

## SENTRY KEY

The Sentry Key Immobilizer system prevents unauthorized vehicle operation by disabling the engine. The system does not need to be armed or activated. Operation is automatic, regardless of whether the vehicle is locked or unlocked.

The system uses a key fob, keyless push button ignition and a Radio Frequency (RF) receiver to prevent unauthorized vehicle operation. Therefore, only key fobs that

are programmed to the vehicle can be used to start and operate the vehicle. The system cannot reprogram a key fob obtained from another vehicle.

After placing the ignition in the ON/RUN position, the Vehicle Security Light will turn on for three seconds for a bulb check. If the light remains on after the bulb check, it indicates that there is a problem with the electronics. In addition, if the light begins to flash after the bulb check, it indicates that someone attempted to start the engine with an invalid key fob. If a valid key fob is used to start the engine but there is an issue with the vehicle electronics, the engine will start and shut off after two seconds.

If the Vehicle Security Light turns on during normal vehicle operation (vehicle running for longer than 10 seconds), it indicates that there is a fault in the electronics. Should this occur, have the vehicle serviced as soon as possible by an authorized dealer.

**CAUTION!**

The Sentry Key Immobilizer system is not compatible with some aftermarket Remote Start systems. Use of these systems may result in vehicle starting problems and loss of security protection.

All of the key fobs provided with your new vehicle have been programmed to the vehicle electronics  
 ➔ page 318.

**NOTE:**

A key fob that has not been programmed is also considered an invalid key.



## IGNITION SWITCH

### KEYLESS ENTER 'N GO™ IGNITION

If applicable, refer to the “Hybrid Supplement” for additional information.

This feature allows the driver to operate the ignition switch with the push of a button as long as the key fob is in the passenger compartment.

The START/STOP ignition button has four operating positions; three of which are labeled and will illuminate when in position. The three positions are OFF, ACC, and ON/RUN. The fourth position is START. During START, RUN will illuminate.

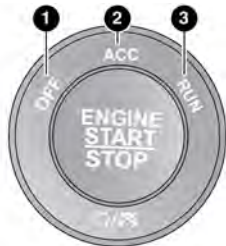

A0205000012US

Keyless Push Button Ignition

- 1 – OFF
- 2 – ACC
- 3 – ON/RUN

The push button ignition can be placed in the following modes:

#### OFF

- The engine is stopped
- Some electrical devices (e.g. power locks, alarm, etc.) are still available

#### ACC

- The engine is stopped
- Some electrical devices are available (e.g. power windows)

#### ON/RUN

- Driving position
- All electrical devices are available (e.g. climate controls, etc.)

#### START

- The engine will start (when foot is on the brake pedal)

The engine only runs with the ignition in the ON/RUN ignition position, or from a Remote Start request.

In case the ignition switch does not change with the push of a button, the key fob may have a low or depleted battery. In this situation, a backup method can be used to operate the ignition switch. Put the nose side (side opposite of the emergency key) of the key fob against the START/STOP ignition button and push to operate the ignition switch.



Backup Starting Method

#### WARNING!

- When leaving the vehicle, always remove the key fob from the vehicle and lock your vehicle.
- Never leave children alone in a vehicle, or with access to an unlocked vehicle.
- Allowing children to be in a vehicle unattended is dangerous for a number of reasons. A child or others could be seriously or fatally injured. Children should be warned not to touch the parking brake, brake pedal or the gear selector.
- Do not leave the key fob in or near the vehicle, or in a location accessible to children, and do not leave the Keyless Enter 'n Go™ Ignition in the ON/RUN position. A child could operate power windows, other controls, or move the vehicle.
- Do not leave children or animals inside parked vehicles in hot weather. Interior heat buildup may cause serious injury or death.

**CAUTION!**

An unlocked car is an invitation for thieves. Always remove the key fobs from the vehicle and lock all doors when leaving the vehicle unattended.

**NOTE:**

- The key fob may not be detected by the vehicle Keyless Enter 'n Go™ system if it is located next to a mobile phone, laptop or other electronic device; these devices may block the key fob's wireless signal and prevent the Keyless Enter 'n Go™ system from starting the vehicle.
- For the proper engine starting procedure, see  page 119.

## KEYLESS ENTER 'N GO™ IGNITION — HYBRID MODELS ONLY

This feature allows the driver to operate the ignition switch with the push of a button as long as the key fob is in the passenger compartment.

**NOTE:**

This vehicle is equipped with an automatic shutdown feature. If the vehicle is left in READY state (vehicle running) with the gear selector in the PARK position for 30 minutes, it will automatically turn off the vehicle. Notifications have been designed into this feature to raise awareness of the timed event. The instrument cluster display will display "Ready To Drive" accompanied with three audible chimes while exiting. The interior warnings will occur regardless of whether the key fob remains in the vehicle or is removed. The horn will sound three times if the fob is removed from the vehicle and the ignition state is in READY mode. To restart the vehicle, follow the normal process for starting your vehicle.

The START/STOP ignition button has four operating positions; three of which are labeled and will illuminate when in position. The three positions are OFF, ACC, and ON/RUN. The fourth position is START. During START, RUN will illuminate.

**NOTE:**

- Pushing the START/STOP ignition button may only activate the Electric Propulsion System and not start the vehicle's engine (if running the engine is not currently required by the Hybrid system). READY will show in the instrument cluster display whenever the vehicle is operating in Electric mode and the vehicle is stationary.
- If the vehicle's ignition is in either ACC or ON/RUN, the vehicle charge indicator may not display a value greater than 99% state of charge due to vehicle loads.

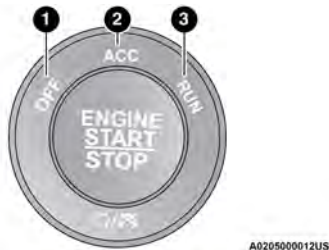

**Keyless Push Button Ignition**

- 1 — OFF  
2 — ACC  
3 — ON/RUN

The ignition can be placed in the following positions:

**OFF**

- The vehicle is stopped
- Some electrical devices (e.g. power locks, alarm system, etc.) are still available

**ACC**

- Some electrical devices are available (e.g. power windows)
- Mechanical power (vehicle propulsion) is not available

**ON/RUN**

- Driving position
- All electrical devices are available (e.g. climate controls, etc.)
- As long as the READY appears in the instrument cluster display, it does not matter if the engine is running, vehicle propulsion is available

**NOTE:**

Vehicle propulsion is only available after the vehicle has passed through the START position.

**Conditions Which May Cause The Engine To Run**

- While maintaining the Hybrid Battery State of Charge (SOC)
- When applying maximum vehicle acceleration
- When maximum passenger compartment heating has been turned on
- While maintaining the Exhaust System Catalyst Temperature (after engine start in current ignition cycle - emissions requirement)
- When the engine is temporarily operating in Fuel and Oil Refresh Mode

- When the hood is open with the ignition in ON/RUN, post-START mode (eliminates unexpected engine start-ups)

In case the ignition switch does not change with the push of the button, the key fob may have a low or depleted battery. In this situation, a backup method can be used to operate the ignition switch. Put the nose side (side opposite of the emergency key) of the key fob against the START/STOP ignition button and push to operate the ignition switch.



**Keyless Push Button Ignition**

#### WARNING!

- When leaving the vehicle, always remove the key fob from the vehicle and lock your vehicle.
- Never leave children alone in a vehicle, or with access to an unlocked vehicle.
- Allowing children to be in a vehicle unattended is dangerous for a number of reasons. A child or others could be seriously or fatally injured. Children should be warned not to touch the parking brake, brake pedal or the gear selector.

*(Continued)*

#### WARNING!

- Do not leave the key fob in or near the vehicle, or in a location accessible to children, and do not leave the Keyless Enter 'n Go™ Ignition in the ACC or ON/RUN position. A child could operate power windows, other controls, or move the vehicle.
- Do not leave children or animals inside parked vehicles in hot weather. Interior heat buildup may cause serious injury or death.

#### CAUTION!

An unlocked vehicle is an invitation for theft. Always turn the vehicle off, remove the key fobs from the vehicle, and lock all the doors when leaving the vehicle unattended.

If the brake is pressed and the ignition is placed in the RUN position with an EVSE connected to the vehicle, the instrument cluster display will not display the READY state. When the Electric Vehicle Supply Equipment (EVSE) is unplugged from the vehicle, the vehicle will go into the READY state. If the vehicle is not shifted out of PARK 30 minutes after being unplugged, the vehicle will disable the READY state and transition the ignition to OFF.

For more information on normal starting, see [page 122](#).

## REMOTE START — IF EQUIPPED

If applicable, refer to the “Hybrid Supplement” for additional information.



This system uses the key fob to start the engine conveniently from outside the vehicle while still maintaining security. The system has a range of approximately 328 ft (100 m).

Remote Start is used to defrost windows in cold weather, and to reach a comfortable climate in all ambient conditions before the customer enters the vehicle.

#### NOTE:

Obstructions between the vehicle and key fob may reduce this range [page 318](#).

#### WARNING!

- Do not start or run an engine in a closed garage or confined area. Exhaust gas contains carbon monoxide which is odorless and colorless. Carbon monoxide is poisonous and can cause serious injury or death when inhaled.
- Keep key fobs away from children. Operation of the Remote Start system, windows, door locks or other controls could cause serious injury or death.

## HOW TO USE REMOTE START

Push and release the Remote Start button on the key fob twice within five seconds. The vehicle doors will lock, the parking lights will flash, and the horn will chirp twice (if programmed). Then, the engine will start, and the vehicle will remain in the Remote Start mode for a 15 minute cycle.

Pushing the Remote Start button a third time shuts the engine off.

To drive the vehicle, push the unlock button, and place the ignition in the ON/RUN position.

#### NOTE:

- With Remote Start, the engine will only run for 15 minutes.
- Remote Start can only be used twice.
- If an engine fault is present or fuel level is low, the vehicle will start and then shut down after 10 seconds.
- The parking lights will turn on, and remain on, during Remote Start mode.
- For security, power window and power sunroof (if equipped) operation are disabled when the vehicle is in the Remote Start mode.
- The ignition must be placed in the ON/RUN position before the Remote Start sequence can be repeated for a third cycle.

All of the following conditions must be met before the engine will remote start:

- Gear selector in PARK
- Doors closed
- Hood closed
- Liftgate closed
- Hazard switch off
- Brake switch inactive (brake pedal not pressed)
- Battery at an acceptable charge level
- Panic button not pushed
- System not disabled from previous Remote Start event

- Vehicle Security Light flashing
- Ignition in OFF position
- Fuel level meets minimum requirement
- Vehicle Security system is not signaling an intrusion
- Malfunction Indicator Light (MIL) is not illuminated

#### WARNING!

- Do not start or run an engine in a closed garage or confined area. Exhaust gas contains carbon monoxide which is odorless and colorless. Carbon monoxide is poisonous and can cause serious injury or death when inhaled.
- Keep key fobs away from children. Operation of the Remote Start system, windows, door locks or other controls could cause serious injury or death.

## TO EXIT REMOTE START MODE

To drive the vehicle after starting the Remote Start system, either push and release the unlock button on the key fob to unlock the doors, or unlock the vehicle using Keyless Enter 'n Go™ — Passive Entry via the door handles, and disarm the Vehicle Security system (if equipped). Then, prior to the end of the 15 minute cycle, push and release the START/STOP ignition button.

The Remote Start system will turn the engine off with another push and release of the Remote Start button on the key fob, or if the engine is allowed to run for the entire 15 minute cycle. Once the ignition is placed in the ON/RUN position, the climate controls will resume previously set operations (temperature, blower control, etc.).

#### NOTE:

- For vehicles equipped with the Keyless Enter 'n Go™ — Passive Entry feature, the message “Remote Start Active — Push Start Button” will show in the instrument cluster display until you push the START/STOP ignition button.
- To avoid unintentional shutdowns, the system will disable for two seconds after receiving a valid Remote Start request.

## REMOTE START FRONT DEFROST ACTIVATION — IF EQUIPPED

When Remote Start is active, and the outside ambient temperature is 40°F (4.5°C) or below, the system will automatically activate front defrost for 15 minutes or less. The timing is dependent on the ambient temperature. Once the timer expires, the system will automatically adjust the settings depending on ambient conditions. See “Remote Start Comfort Systems — If Equipped” in the next section for detailed operation.

## REMOTE START COMFORT SYSTEMS — IF EQUIPPED

When Remote Start is activated, the front and rear defroster will automatically turn on in cold weather conditions. The heated steering wheel and driver heated seat feature will turn on if programmed in the Comfort menu screen within Uconnect Settings  page 169. In warm weather, the driver vented seat feature will automatically turn on when Remote Start is activated, if programmed in the Comfort menu screen. The vehicle will adjust the climate control settings depending on the outside ambient temperature.

**NOTE:**

If the vehicle is equipped with a rear climate system, it will remain off to allow for optimal front row performance.

**Automatic Temperature Control (ATC) — If Equipped**

The climate controls will automatically adjust to the optimal temperature and mode settings depending on the outside ambient temperature. This will occur until the ignition is placed in the ON/RUN position where the climate controls will resume their previous settings.

**Manual Temperature Control (MTC) — If Equipped**

- In ambient temperatures of 40°F (4.5°C) or below, the climate settings will default to maximum heat, with fresh air entering the cabin. If the front defrost timer expires, the vehicle will enter Mix mode.
- In ambient temperatures from 40°F (4.5°C) to 78°F (26°C), the climate settings will be based on the last settings selected by the driver.
- In ambient temperatures of 78°F (26°C) or above, the climate settings will default to MAX A/C, Bi-Level mode, with Recirculation on.

For more information on ATC, MTC, and climate control settings, see ↪ page 67.

**NOTE:**

These features will stay on through the duration of Remote Start, or until the ignition is placed in the ON/RUN position. The climate control settings will change, and exit the automatic defaults, if manually adjusted by the driver while the vehicle is in Remote Start mode. This includes turning the climate controls off using the OFF button.

**REMOTE START WINDSHIELD WIPER DE-ICER ACTIVATION — IF EQUIPPED**

When Remote Start is active and the outside ambient temperature is less than 33°F (0.6°C), the Windshield Wiper De-Icer will activate. Exiting Remote Start will resume its previous operation. If the Windshield Wiper De-Icer was active, the timer and operation will continue.

**REMOTE START CANCEL MESSAGE**

One of the following messages will display in the instrument cluster display if the vehicle fails to remote start or exits Remote Start prematurely:

- Remote Start Canceled — Door Open
- Remote Start Canceled — Hood Open
- Remote Start Canceled — Liftgate Open
- Remote Start Canceled — Fuel Low
- Remote Start Canceled — Time Expired
- Remote Start Canceled — System Fault
- Remote Start Disabled — Start Vehicle to Reset

The instrument cluster display message stays active until the ignition is placed in the ON/RUN position.

**REMOTE START SYSTEM (BEV) — IF EQUIPPED****NOTE:**

**Remote Start on BEV while plugged in may not always start the engine.**



This system uses the key fob to start the vehicle conveniently from outside the vehicle while still maintaining security. The system has a range of 328 ft (100 m).

The Remote Start system also activates the Climate Control system and vented seats (if equipped) in temperatures above 80°F (26.7°C). It activates the optional heated seats, optional heated steering wheel, optional heated mirrors and rear defroster in temperatures below 40°F (4.4°C).

**NOTE:**

Obstructions between the vehicle and key fob may reduce this range.

**HOW TO USE REMOTE START**

Push and release the Remote Start button on the key fob twice within five seconds. The vehicle doors will lock, the parking lights will flash, and the horn will chirp twice (if programmed). Then, the vehicle will start, and remain in the Remote Start mode for a 15 minute cycle. Pushing the Remote Start button a third time shuts the vehicle off.

**NOTE:**

- With Remote Start, the vehicle will only run for 15 minutes.
- Remote Start can only be used twice.
- If an engine fault is present or fuel level is low, the vehicle will start and then shut down in 10 seconds.
- The parking lights will turn on and remain on during Remote Start mode.
- For security, power window and power sunroof (if equipped) operations are disabled when the vehicle is in Remote Start mode.
- The ignition must be placed in the ON/RUN position before the Remote Start sequence can be repeated for a third cycle.

All of the following conditions must be met before the vehicle will remote start:

- Gear selector in PARK
- Doors closed
- Hood closed
- Liftgate closed
- Hazard switch off
- Brake switch inactive (brake pedal not pressed)
- 12 Volt battery at an acceptable charge level
- Key fob Panic button not pushed
- System not disabled from previous Remote Start event
- Vehicle Security system indicator flashing
- Ignition in the OFF position
- Fuel level meets minimum requirement

- Malfunction Indicator Light (MIL) is off while vehicle is in propulsion system active
- Electronic Throttle Control (ETC) Warning Light is not illuminated
- Electric Vehicle Service Light is not illuminated

**WARNING!**

- Do not start or run an engine in a closed garage or confined area. Exhaust gas contains carbon monoxide which is odorless and colorless. Carbon monoxide is poisonous and can cause serious injury or death when inhaled.
- Keep key fobs away from children. Operation of the Remote Start system, windows, door locks or other controls could cause serious injury or death.

**TO EXIT REMOTE START MODE**

Push and release the Remote Start button one time or allow the Remote Start cycle to complete the entire 15 minute cycle.

In addition, the ignition can be cycled to the RUN (Pre-Propulsion System Active) position by pressing the ignition button with the key fob in the vehicle, and then pushing the ignition button one more time to place the ignition in the OFF position.

**NOTE:**

To avoid unintentional shutdowns, the system will temporarily disable for two seconds after receiving a valid Remote Start request.

**SCHEDULED CABIN CONDITIONING (SCC)**

This feature allows the driver to pre-condition (warm up or cool down) the passenger cabin based on a planned departure time. The target temperature is preset to the same values used by the Remote Start feature. Unlike Remote Start, the driver does not need to initiate the cabin conditioning by pushing the Remote Start button, instead, a programmed departure time will be used. Also, all scheduled cabin conditioning will be powered by the vehicle's high voltage battery working in conjunction with any EVSE connected to the vehicle. Unlike Remote Start, in SCC the vehicle's gas engine will not start to provide power or heat for cabin conditioning.

In order to conserve the vehicle's high voltage battery power, the driver can choose between allowing the battery to be drained of power down to <1%, or to stop the SCC when the high voltage battery has been depleted to 25% State Of Charge (SOC). The battery percentages are displayed in the instrument cluster display.

A maximum of three independent schedule event timers are available for use by the SCC feature and Scheduled Charging feature for charging the high voltage battery. The timers may be used in any combination for SCC and Scheduled Charging, but only three total timers are available.

The SCC event times are used to wake up the vehicle so that the Climate Control system can condition the passenger cabin prior to the scheduled departure time. Based on vehicle operating conditions, ambient temperature, and the next programmed departure time, the vehicle will determine when to begin cabin conditioning. Cabin conditioning can begin up to 30 minutes prior to the scheduled departure time, provided the stated high voltage battery conditions are met.

The SCC will continue for a maximum of 15 minutes after the scheduled departure time.

Once a scheduled event has been created, it can be applied to one or more days of the week. The scheduled event can also be set to occur only during the current week, or repeat every week until the feature is turned off or the event is changed.

All of the following conditions must be met before the vehicle will initiate a scheduled SCC event:

- Gear selector in PARK
- Doors Closed
- Hood Closed
- Liftgate Closed
- Hazard switch off
- 12 Volt battery at an acceptable charge level
- Key fob not located inside the vehicle
- Ignition in the OFF position
- Remote Start has not been activated

#### Scheduling An SCC Event:

1. Select the Hybrid Electric App on the touchscreen.
2. Select “Schedules”.



Schedules Screen

3. Select the schedule to be set (1,2, or 3) by pressing the appropriate arrow on the right side of the touchscreen.
4. Choose “Climate Schedule”.



Select Climate Schedule

5. Select if SCC should stop when the high voltage battery drops to 25% or lower.
6. Set the Departure Time: Hours, Minutes, and AM/PM.



Set Climate Schedule

7. Select the days that this SCC event will occur. The “Repeat” indicator illuminates to indicate that SCC will occur every week on the selected day(s), at the selected time.  
If you uncheck the “Repeat” option, all the days of the week will be grayed out and the vehicle will perform only one SCC event, which will occur at the next available time that matches the SCC event time (regardless of what day it was originally set to occur before “Repeat” was unchecked).
8. To schedule another SCC event, press the X and repeat these steps.

## VEHICLE SECURITY SYSTEM — IF EQUIPPED

The Vehicle Security system monitors the vehicle doors for unauthorized entry and the ignition switch for unauthorized operation. When the alarm is activated, the interior switches for door locks, power sliding doors and power liftgate are disabled. The Vehicle Security system provides both audible and visible signals. If something triggers the alarm, the Vehicle Security system will provide the following audible and visible signals: the horn will pulse, the parking lights and/or turn signals will flash, and the Vehicle Security Light in the instrument cluster will flash.

## TO ARM THE SYSTEM

Follow these steps to arm the Vehicle Security system:

1. Make sure the vehicle's ignition is placed in the OFF position.
  - For vehicles equipped with Keyless Enter 'n Go™ — Passive Entry, make sure the vehicle ignition system is OFF.
2. Perform one of the following methods to lock the vehicle:
  - Push lock on the interior power door lock switch with the driver and/or passenger door open.
  - Push the lock button on the exterior Passive Entry door handle with a valid key fob available in the same exterior zone ↪ page 31.
  - Push the lock button on the key fob.
3. If any doors are open, close them.

## TO DISARM THE SYSTEM

The Vehicle Security system can be disarmed using any of the following methods:

- Push the unlock button on the key fob.
- Grab the Passive Entry door handle (if equipped) ↪ page 31.
- Hands-Free Liftgate Passive Entry activation (if equipped).
- Cycle the vehicle ignition system out of the OFF position.
  - For vehicles equipped with Keyless Enter 'n Go™ — Passive Entry, push the START/STOP ignition button (requires at least one valid key fob in the vehicle).

### NOTE:

- The driver's door key cylinder and the liftgate button on the key fob cannot arm or disarm the Vehicle Security system.
- The Vehicle Security system remains armed during power liftgate entry. Pushing the liftgate button will not disarm the Vehicle Security system. If someone enters the vehicle through the liftgate and opens any door, the alarm will sound.
- When the Vehicle Security system is armed, the interior power door lock switches will not unlock the doors.

The Vehicle Security system is designed to protect your vehicle. However, you can create conditions where the system will give you a false alarm. If one of the previously described arming sequences has occurred, the Vehicle Security system will arm regardless of whether you are in the vehicle or not. If you remain in the vehicle and open a door, the alarm will sound. If this occurs, disarm the Vehicle Security system.

If the Vehicle Security system is armed and the battery becomes disconnected, the Vehicle Security system will remain armed when the battery is reconnected; the exterior lights will flash, and the horn will sound. If this occurs, disarm the Vehicle Security system.

## REARMING OF THE SYSTEM

If something triggers the alarm and no action is taken to disarm it, the Vehicle Security system will turn the horn off after a 29 second cycle (with five seconds between cycles and up to 8 cycles if the trigger remains active) and then rearm itself.

## SECURITY SYSTEM MANUAL OVERRIDE

The Vehicle Security system will not arm if you lock the doors using the manual door lock.

## DOORS

### MANUAL DOOR LOCKS

To lock each door, rotate the door lock on each door trim panel forward. To unlock the front doors, pull the inside door handle to the first detent or rotate the door lock button until the ribbing is visible. To unlock the rear doors, rotate the door lock button until the red indicator is visible.

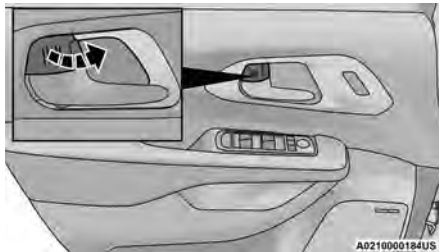

**Manual Front Door Lock**



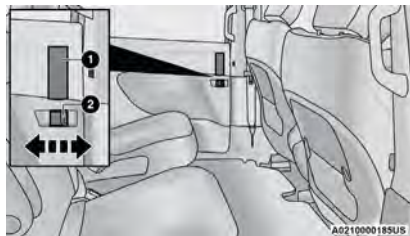

**Manual Rear Door Lock**

- 1 — Door Handle  
2 — Manual Door Lock

If the door lock is in the locked position (no ribbing is visible) when you shut the door, the door will lock. Therefore, make sure the key fob is not inside the vehicle before closing the door.

**NOTE:**

The manual door locks will not lock or unlock the liftgate.

**WARNING!**

- For personal security and safety in the event of a collision, lock the vehicle doors before you drive as well as when you park and leave the vehicle.
- Never use the PARK position as a substitute for the parking brake. Always apply the parking brake fully when parked to guard against vehicle movement and possible injury or damage.

*(Continued)*

**WARNING!**

- When exiting the vehicle, always make sure the ignition is in the OFF position, remove the key fob from the vehicle and lock the vehicle.
- Never leave children alone in a vehicle, or with access to an unlocked vehicle. Allowing children to be in a vehicle unattended is dangerous for a number of reasons. A child or others could be seriously or fatally injured. Children should be warned not to touch the parking brake, brake pedal or the gear selector.
- Do not leave the key fob in or near the vehicle, or in a location accessible to children, and do not leave the Keyless Enter 'n Go™ Ignition in the ACC or ON/RUN position. A child could operate power windows, other controls, or move the vehicle.

**POWER DOOR LOCKS —  
IF EQUIPPED**

A power door lock switch is on each front door trim panel. Use this switch to lock or unlock the doors.

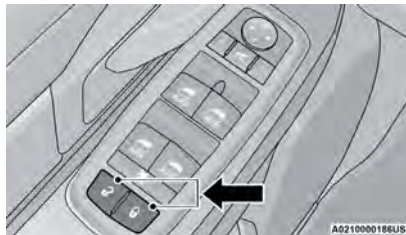

**Driver Power Door Lock Switches**

If you push the power door lock switch while the ignition is in the ACC or ON/RUN position, and any front door is open, the power locks will not operate. This prevents you from accidentally locking your key fob in the vehicle. Placing the ignition in the OFF position or closing the door will allow the locks to operate. A chime will sound if the ignition is in the ACC or ON/RUN position and a door is open, as a reminder to place the ignition in the OFF position and remove the key fob.

**KEYLESS ENTER 'N GO™ —  
PASSIVE ENTRY**

The Passive Entry system is an enhancement to the vehicle's Remote Keyless Entry system. This feature allows you to lock and unlock the vehicle's door(s) without having to push the key fob lock or unlock buttons.

**NOTE:**

- Passive Entry may be programmed on/off through the Uconnect system → page 169.
- The key fob may not be detected by the Passive Entry system if it is located next to a mobile phone, laptop, or other electronic device; these devices may block the key fob's wireless signal and prevent the Passive Entry handle from locking/unlocking the vehicle.
- If set by the customer in the Uconnect Settings, unlocking with Passive Entry will initiate illuminated approach (low beams, license plate light, parking lights) for the duration of 0, 30, 60 or 90 seconds. Passive Entry also initiates two flashes of the turn signals.

- If wearing gloves, if it has been raining/snowing, or there is salt/dirt covering the Passive Entry door handle, the unlock sensitivity can be affected, resulting in a slower response time.
- The doors may unlock when water is sprayed on the Passive Entry door handles, if the key fob is located outside of the vehicle within 5 ft (1.5 m) of the handle.
- If the vehicle is unlocked by Passive Entry and no door is opened within 60 seconds, the vehicle will relock and will arm the Vehicle Security system (if equipped).
- The sliding side doors can be unlocked from the outside using the hands-free or Passive Entry system.

#### To Unlock From The Driver Or Passenger Side:

With a valid key fob within 5 ft (1.5 m) of the door handle, grab the handle to unlock the vehicle. Grabbing the driver's door handle will unlock the driver's side doors (driver/sliding door) automatically. Grabbing the front passenger door handle will unlock all four doors and the liftgate automatically. The interior door panel lock knob will rotate when the door is unlocked.

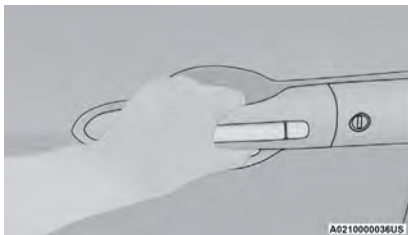

**Grab The Door Handle To Unlock**

#### NOTE:

- Either the driver door only or all doors will unlock when you grab hold of the front driver's door handle, depending on the selected setting in the Uconnect system → page 169.
- All doors will unlock when the front passenger door handle is grabbed regardless of the driver's door unlock preference setting.

#### Frequency Operated Button Integrated Key (FOBIK-Safe)

To minimize the possibility of unintentionally locking a key fob inside your vehicle, the Passive Entry system is equipped with an automatic door unlock feature.

There are three situations that trigger a FOBIK-Safe search in any Passive Entry vehicle:

- A lock request is made by a valid key fob while a door is open.
- A lock request is made by the Passive Entry door handle while a door is open.
- A lock request is made by the door panel switch while the door is open.

When any of these situations occur, after all open doors are shut, the FOBIK-Safe search will be executed. If it detects a key fob inside the car, and it does not detect any key fob outside the car, then the car will unlock and alert the customer.

#### NOTE:

The vehicle will only unlock the doors when a valid Passive Entry key fob is detected inside the vehicle, and no valid key fob is detected outside the vehicle. The vehicle will not unlock the doors when any of the following conditions are met:

- The doors are manually locked using the door lock knobs.
- Three attempts are made to lock the doors using the door panel switch and then the doors are closed.
- There is a valid Passive Entry key fob outside the vehicle and within 5 ft (1.5 m) of either Passive Entry door handle.

#### NOTE:

On the third attempt ALL doors will lock and the key fob can be locked in the vehicle.

#### To Lock The Vehicle's Doors And Liftgate

With one of the vehicle's key fobs within 5 ft (1.5 m) of the driver or passenger front door handle, push the door handle lock button to lock all four doors and the liftgate.

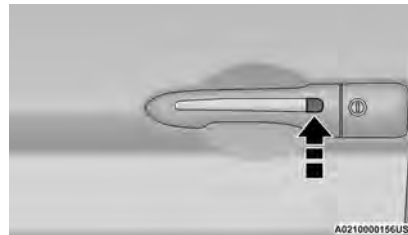

**Push The Door Handle Button To Lock**

Do NOT grab the door handle when pushing the door handle button. This could unlock the door(s).



#### Do NOT Grab The Door Handle When Locking

#### NOTE:

- After pushing the door handle lock button, you must wait two seconds before you can lock or unlock the doors, using either Passive Entry door handle. This is done to allow you to check if the vehicle is locked by pulling the door handle, without the vehicle unlocking.
- If Passive Entry is disabled using the Uconnect Settings, the key fob protection described in "Frequency Operated Button Integrated Key (FOBIK-Safe)" remains active/functional.
- The Passive Entry system will not operate if the key fob battery is depleted.

#### To Unlock/Enter The Liftgate

The liftgate Passive Entry unlock feature is built into the electronic liftgate release handle. With a valid Passive Entry key fob within 5 ft (1.5 m) of the liftgate, push the electronic liftgate release handle for a power open on vehicles equipped with Power Liftgate. Pull the electronic liftgate handle and lift for manual liftgate vehicles → page 318.



Electronic Liftgate Release Handle

#### AUTOMATIC UNLOCK DOORS ON EXIT — IF EQUIPPED

The Unlock Doors Automatically On Exit feature unlocks all of the vehicle doors when any door is opened. This will occur only after the gear selector has been placed into the PARK position, after the vehicle has been driven (the gear selector has been placed out of PARK and all doors closed).

The Unlock Doors Automatically On Exit feature will not operate if there is any manual operation of the door locks (lock or unlock).

This feature can be turned on or off in the Uconnect system → page 169.

## MANUAL SLIDING SIDE DOOR

The sliding door may be opened from the inside or the outside. Pull outward on the exterior handle to open the sliding door. The sliding door inside handle functions by rocking forward and back. Rocking the handle backwards opens the door and rocking forward releases the hold open latch in order to close the door.

#### NOTE:

If equipped with power sliding doors, using the manual door handle will activate the power opening/closing function. Allow the door to open or close fully on its own, without forcing it.

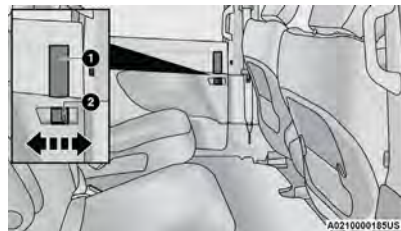

Side Door Handle And Lock Functions

- 1 — Door Handle
- 2 — Door Lock

To keep your door operating properly, observe the following guidelines:

- Always open the door smoothly.
- Avoid high impacts against the door stop when opening the door. This is very important when your vehicle is parked on an incline as the door will slide faster in the downhill direction.

- There is a hold-open latch that is activated when the sliding door is fully opened. This latch will keep your sliding door open on any incline. To close the sliding door after the hold-open latch is activated, you must rock the inside handle forward or pull outward on the exterior handle.

Always make sure that the sliding door is fully latched anytime the vehicle is in motion.

#### NOTE:

The left side sliding door cannot be opened while the fuel door is open. If attempted, a message will appear in the instrument cluster display, and the door will automatically return to the closed position.

## POWER SLIDING SIDE DOOR — IF EQUIPPED

The power sliding door may be power opened or closed in several ways:

- Key fob
- Inside or outside handles
- Buttons located:
  - In the overhead console
  - Just inside the sliding door
  - On the outside handle



Push the button on the key fob twice within five seconds to open, close, or reverse a power sliding door.

The key fob and the overhead console button will operate the door when the door is locked. All other ways require the sliding door to be unlocked. If the vehicle is equipped with Passive Entry, pushing the button on the outside handle or Hands-Free feature (if equipped) will unlock and open the sliding door, with a valid Passive Entry key fob within 5 ft (1.5 m) of the door handle.

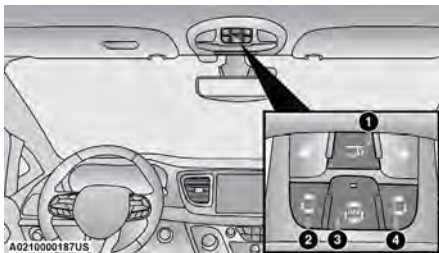

**Overhead Console Power Switches**

- 1 — Liftgate
- 2 — Left Sliding Door
- 3 — Sliding Door Power Off
- 4 — Right Sliding Door

There is a power sliding side door switch located on the B-pillar trim panel on the driver's and passenger's side, just in front of the power sliding door for the rear seat passengers.

To operate the sliding door manually with the handles or to avoid unintentional operation of the power sliding doors from the rear seats, push the power sliding door power off button, located in the overhead console, to remove power to the handles and buttons just inside the sliding doors. The power off LED, in the overhead console, will be lit when the handles are manual. When the LED is lit, pushing the power sliding door power off button will return the handles to power operation.

#### NOTE:

- If anything obstructs the power sliding side door while it is closing or opening, the door will automatically reverse to the closed or open position and an audible tone will sound, provided it meets sufficient resistance. The turn signals will flash with sliding door movements.
- If the power sliding door stops in the middle due to obstacles, it will power open on the next command.



**Power Sliding Side Door Switch (Left Side Shown)**

#### WARNING!

- Personal injury or cargo damage may occur if caught in the path of the sliding door. Make sure the door path is clear before closing the door.
- Before driving off, check the instrument cluster for a sliding door or door open message or warning indicator. Failure to do this could result in unintentionally leaving the sliding door open while driving.

## HANDS-FREE SLIDING DOORS — IF EQUIPPED

To open the Hands-Free Sliding Doors, use a straight in and out kicking motion, move your foot from side to side, or in a sweeping motion, under the vehicle in the general location below the door handle(s).

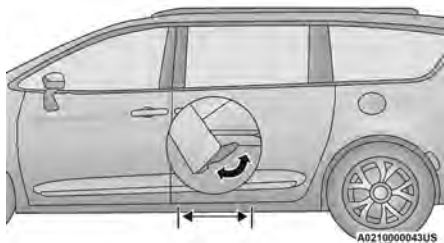

**Activation Zone**

When a valid kicking motion is completed, the sliding door will chime, the hazard lights will flash and the sliding door will open almost instantaneously. This assumes all options are enabled in the Uconnect Settings.

### NOTE:

- To open the Hands-Free Sliding Doors requires a valid Passive Entry key fob within 5 ft (1.5 m) of the door handle. If a valid Passive Entry key fob is not within 5 ft (1.5 m), the door will not respond to any kicks.
- The Hands-Free Sliding Doors will only operate when the gear selector is in PARK.

- With every movement of the Hands-Free Sliding Doors, an audible tone will sound and the turn signals will flash. You can turn these alerts on or off in the Uconnect system ↗ page 169.
- If anything obstructs the power sliding side door while it is closing or opening, the door will automatically reverse to the closed or open position and an audible tone will sound, provided it meets sufficient resistance. The turn signals will flash with sliding door movements.
- If the power sliding doors encounter multiple obstructions within the same cycle, the system will automatically stop.

The Hands-Free Sliding Doors feature may be turned off through Uconnect Settings ↗ page 169.

### NOTE:

The Hands-Free Sliding Doors feature should be turned off during jacking, tire changing, and vehicle service.

## CHILD PROTECTION DOOR LOCK SYSTEM — REAR DOORS

To provide a safer environment for small children riding in the rear seats, the sliding doors are equipped with a Child Protection Door Lock system.

### To Engage The Child Protection Door Lock

1. Open the sliding side door.
2. On the rear of the sliding door, slide the Child Protection Door Lock control inward (toward the vehicle) to engage the Child Protection Door Lock.

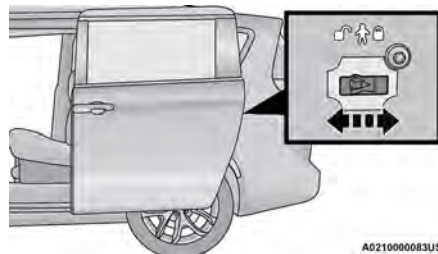

**Child Protection Door Locks**

3. Repeat Steps 1 and 2 on the opposite sliding door.

### NOTE:

- After engaging the Child Protection Door Lock, always test the inside door handle with the sliding door closed to make certain the Child Protection Door Lock is in the locked position.
- After disengaging the Child Protection Door Lock, always test the inside door handle with the sliding door closed to make certain the Child Protection Door Lock is in the unlocked position.
- The inside door handle will not open the sliding door when the Child Protection Door Lock is engaged.
- The power sliding door will operate from the switch located just inside the sliding door, regardless of the Child Protection Door Lock lever position.

- To avoid unintentional operation of the power sliding door from the rear seats, push the Sliding Door Power Off button, located in the overhead console. When the overhead console power OFF LED is illuminated, the sliding door may not be power opened or closed by pushing the buttons just inside the sliding doors or pulling on the handles.

**WARNING!**

Avoid trapping anyone in the vehicle in a collision. Remember that the sliding doors cannot be opened from the inside door handle when the Child Protection Door Locks are engaged.

**To Disengage The Child Protection Door Lock**

1. Open the sliding side door.
2. Slide the Child Protection Door Lock control outward (away from the vehicle) to disengage the Child Protection Door Lock.
3. Repeat Steps 1 and 2 on the opposite sliding door.

**NOTE:**

After disengaging (or engaging) the Child Protection Door Lock, always test the inside door handle with the sliding door closed to make certain the Child Protection Door Lock is in the desired position. The inside door handle will open the sliding door when the Child Protection Door Lock is disengaged.

**STEERING WHEEL****TILT/TELESCOPING STEERING COLUMN**

This feature allows you to tilt the steering column upward or downward. It also allows you to lengthen or shorten the steering column. The tilt/telescoping lever is located left of the steering wheel at the end of the steering column.

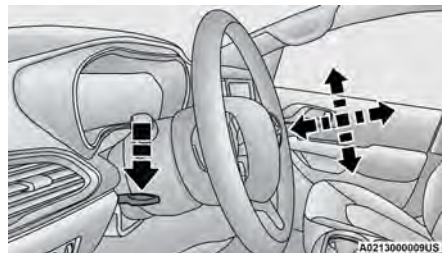
**Tilt/Telescoping Lever**

To unlock the steering column, push the lever downward (toward the floor). To tilt the steering column, move the steering wheel upward or downward as desired. To lengthen or shorten the steering column, pull the steering wheel outward or push it inward as desired. To lock the steering column in position, push the lever upward until fully engaged.

**WARNING!**

Do not adjust the steering column while driving. Adjusting the steering column while driving or driving with the steering column unlocked, could cause the driver to lose control of the vehicle. Failure to follow this warning may result in serious injury or death.

**HEATED STEERING WHEEL — IF EQUIPPED**

The steering wheel contains a heating element that helps warm your hands in cold weather. The heated steering wheel has only one temperature setting. Once the heated steering wheel has been turned on, it will stay on until the operator turns it off. The heated steering wheel may not turn on when it is already warm.

The heated steering wheel button is located within the Uconnect system and, if equipped, on the instrument panel below the radio. You can access the button through the Climate or Controls menu of the touchscreen.

- Press the heated steering wheel button once to turn the heating element on.
- Press the heated steering wheel button a second time to turn the heating element off.

**NOTE:**

The engine must be running for the heated steering wheel to operate.

For information on use with the Remote Start system, see page 26.

**WARNING!**

- Persons who are unable to feel pain to the skin because of advanced age, chronic illness, diabetes, spinal cord injury, medication, alcohol use, exhaustion, or other physical conditions must exercise care when using the steering wheel heater. It may cause burns even at low temperatures, especially if used for long periods.
- Do not place anything on the steering wheel that insulates against heat, such as a blanket or steering wheel covers of any type of material. This may cause the steering wheel heater to overheat.

## DRIVER MEMORY SETTINGS — IF EQUIPPED

This feature allows the driver to save up to two different memory profiles for easy recall through a memory switch. Each memory profile saves desired position settings for the following features:

- Driver's seat
- Easy Entry/Exit seat operation (if equipped)
- Side mirrors (if equipped)
- A set of desired radio station presets

**NOTE:**

- Your vehicle is equipped with two key fobs, each can be linked to either memory position 1 or 2.
- Memory settings will be linked to the driver profiles in the Uconnect system, in addition to several other features (radio presets, home screens, settings, navigation, phone, etc.) ↪ page 169.

The Driver Memory Settings switch is located on the driver door, next to the door handle, and consists of three buttons:

- The set (S) button, which is used to activate the memory save function.
- The (1) and (2) buttons which are used to recall either of two saved memory profiles.

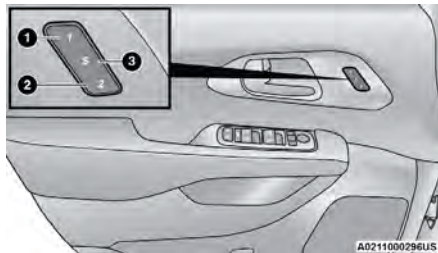

**Driver Memory Switch**

- 1 — Memory Profile Button 1
- 2 — Memory Profile Button 2
- 3 — Set Button

## PROGRAMMING THE MEMORY FEATURE

To create a new memory profile, perform the following:

**NOTE:**

Saving a new memory profile will erase the selected profile from memory.

1. Place the vehicle's ignition in the ON/RUN position (do not start the engine).
2. Adjust all memory profile settings to desired preferences (i.e., driver's seat, outside mirrors and radio station presets).
3. Push the set (S) button on the memory switch, and then push the desired memory button (1 or 2) within five seconds. The instrument cluster display will show which memory position has been set.

**NOTE:**

Memory profiles can be set without the vehicle in PARK.

## LINKING AND UNLINKING THE KEY FOB TO MEMORY

Your key fob can be programmed to recall one of two saved memory profiles.

**NOTE:**

Before programming your key fob you must select the "Personal Settings Linked to Key Fob" feature through the Uconnect Settings ↪ page 169.

To program your key fob, perform the following:

1. Place the vehicle's ignition in the OFF position.
2. Select a desired memory profile 1 or 2.
3. Once the profile has been recalled, push and release the set (S) button on the memory switch.
4. Push and release button (1) or (2) accordingly. "Memory Profile Set" (1 or 2) will display in the instrument cluster.
5. Push and release the lock button on the key fob within 10 seconds.

**NOTE:**

Your key fob can be unlinked from your memory settings by pushing the set (S) button, and then, within 10 seconds, pushing the unlock button on the key fob.

**MEMORY POSITION RECALL****NOTE:**

- The vehicle speed must be less than or equal to 5 mph (8 km/h) to recall memory positions. If a recall is attempted when the vehicle speed is greater than 5 mph (8 km/h), a message will be displayed in the instrument cluster display.
- Memory settings can be linked to driver profiles in the Uconnect system. Changing driver profiles will also recall the linked memory settings if the conditions are met ↪ page 169.

To recall the memory settings for driver one or two, push the desired memory button (1 or 2) on the driver's door or the unlock button on the key fob linked to the desired memory position.

A recall can be canceled by pushing any of the memory buttons on the driver's door during a recall (S, 1, or 2). When a recall is canceled, the driver's seat stops moving. A delay of one second will occur before another recall can be selected.

**NOTE:**

Pushing the mirror adjust switch will cancel the memory mirror recall.

**SEATS**

Seats are a part of the Occupant Restraint system of the vehicle.

**WARNING!**

- It is dangerous to ride in a cargo area, inside or outside of a vehicle. In a collision, people riding in these areas are more likely to be seriously injured or killed.
- Do not allow people to ride in any area of your vehicle that is not equipped with seats and seat belts. In a collision, people riding in these areas are more likely to be seriously injured or killed.
- Be sure everyone in your vehicle is in a seat and using a seat belt properly.

**MANUAL ADJUSTMENT FRONT SEATS — IF EQUIPPED****WARNING!**

- Adjusting a seat while the vehicle is moving is dangerous. The sudden movement of the seat could cause you to lose control. The seat belt might not be adjusted properly and you could be injured. Adjust the seat only while the vehicle is parked.
- Do not ride with the seatback reclined so that the shoulder belt is no longer resting against your chest. In a collision you could slide under the seat belt and be seriously or even fatally injured. Use the recliner only when the vehicle is parked.

**Manual Front Adjuster**

Both front seats are adjustable forward or rearward. The manual seat adjustment handle is located under the seat cushion at the front edge of each seat.

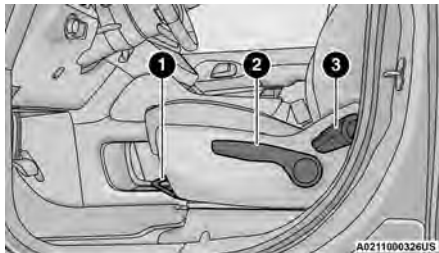
**Manual Seat Adjustment**

- 1 — Forward/Rearward Adjustment Bar  
2 — Height Adjustment  
3 — Recline Lever

While sitting in the seat, pull up on the handle and slide the seat forward or rearward. Release the bar once you have reached the desired position. Then, using body pressure, move forward and rearward on the seat to be sure that the seat adjusters have latched.

**WARNING!**

- Adjusting a seat while driving may be dangerous. Moving a seat while driving could result in loss of control which could cause a collision and serious injury or death.

(Continued)



**WARNING!**

- Seats should be adjusted before fastening the seat belts and while the vehicle is parked. Serious injury or death could result from a poorly adjusted seat belt.

**Manual Seat Height Adjustment**

The driver's seat height can be raised or lowered by using a lever, located on the outboard side of the seat. Pump the lever upward to raise the seat height or pump the lever downward to lower the seat height.

**Manual Front Seat Recline Adjustment**

For models equipped with manual seats, the recline lever is located on the outboard side of the seat.

To recline, lean forward slightly, lift the lever and push back to the desired position and release the lever. Lean forward and lift the lever to return the seatback to its normal position. Using body pressure, lean forward and rearward on the seat to be sure the seatback has latched.

**WARNING!**

Do not ride with the seatback reclined so that the shoulder belt is no longer resting against your chest. In a collision you could slide under the seat belt, which could result in serious injury or death.

**MANUAL ADJUSTMENT REAR SEATS****WARNING!**

- Adjusting a seat while the vehicle is moving is dangerous. The sudden movement of the seat could cause you to lose control. The seat belt might not be adjusted properly and you could be injured. Adjust the seat only while the vehicle is parked.
- Do not ride with the seatback reclined so that the shoulder belt is no longer resting against your chest. In a collision you could slide under the seat belt and be seriously or even fatally injured. Use the recliner only when the vehicle is parked.

**Manual Forward/Rearward Adjustment — Quad Seats (If Equipped)**

Both second row seats are adjustable forward or rearward. The manual seat adjustment handle is located under the seat cushion at the front edge of each seat.

**Manual Rear Seat Adjuster**

While sitting in the seat, pull up on the handle and slide the seat forward or rearward. Release the bar once you have reached the desired position. Then, using body pressure, move forward and rearward on the seat to be sure that the seat adjusters have latched.

**WARNING!**

- Adjusting a seat while driving may be dangerous. Moving a seat while driving could result in loss of control which could cause a collision and serious injury or death.
- Seats should be adjusted before fastening the seat belts and while the vehicle is parked. Serious injury or death could result from a poorly adjusted seat belt.

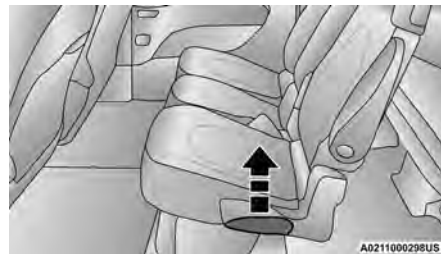
**Manual Recline — Quad Seats****Recline Lever**

To recline, lean forward slightly, lift the lever, and push back to the desired position and release the lever. Lean forward and lift the lever to return the seatback to its normal position. Using body pressure, lean forward and rearward on the seat to be sure the seatback has latched.

**WARNING!**

Do not ride with the seatback reclined so that the shoulder belt is no longer resting against your chest. In a collision you could slide under the seat belt, which could result in serious injury or death.

### Second Row Removable 8th Seat — If Equipped

While the 8th seat does not stow in the floor, it is fold-able and removable for added cargo space.



**Second Row 8th Seat Fold Flat Strap**

The release strap is located on the front of the seat, near the floor. To remove the seat, pull the release strap to release the rear latches. The seat assembly can now be removed from the vehicle by moving it in a rearward direction from the detent positions in the floor.



**Release Strap**

**NOTE:**

The seat can be removed easier with one outboard seat stowed in the load floor.

To reinstall the seat, align the seat into the detent positions on the floor. Tilt seat rearward to lock the seatback into its original position.

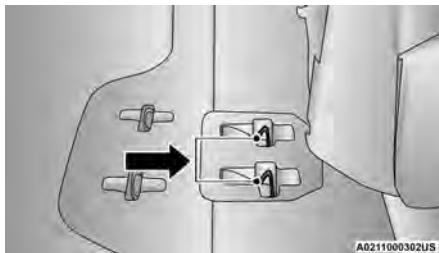

**In Floor Detent Guides**

**WARNING!**

If not properly latched, the seat could become loose. Personal injuries could result.

### Fold-Flat Quad Seats And Stow 'n Go Seats

**NOTE:**

- You may experience deformation in the seat cushion from the seat belt buckles, or wrinkling of the seat fabric if the seats are left folded for an extended period of time. This is normal and by simply unfolding the seats to the open position, over time the seat cushion may return to its normal shape. Having an occupant sit in the seat, or massaging the fabric by hand may smooth away any excess wrinkling.

- Permanent wrinkles may still result.

To fold the seat, lift the recliner lever to the full upward position and push the seatback forward until it rests on the seat cushion.

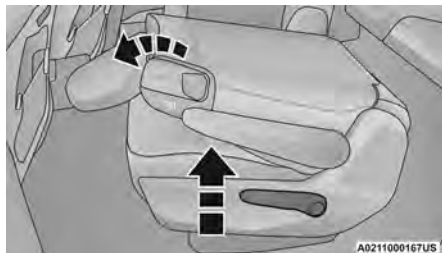

**Fold-Flat Seat Recline Lever**

**NOTE:**

- The seatback may lock into the fold-flat position. Use the recline lever to unlock the seatback.
- If equipped with Stow 'n Go seating: when returning the seat to the original position, the headrest must be folded back to the original position.



**Stow 'n Go Seating Head Restraint**

## Easy Entry

### Easy Tilt Seat — With Or Without Child Seat Installed

The second row seats can be tilted forward for easy entry into the third row with or without a child seat installed.

1. Located in the seatback of the second row seat is a lever (or handle for Stow 'n Go seats) that provides easier access to the third row by tilting the seat forward.
2. Slide the lever upwards, or if equipped, pull the handle forward, to unlock the seatback.



**Lift Easy Tilt Seat Lever (If Equipped)**



**Pull Easy Tilt Seat Handle (If Equipped)**

3. Push on seatback to slide seat forward to access the third row.



**Easy Tilt Seat**

**Easy Tilt With Child Seat Installed**

4. To put the seat back into original position, just pull back on the seatback and lock the seat into position.

**WARNING!**

Do not use this feature with a child in seat. Serious injury or death may occur.

**Easy Entry — With The Seat Folded Flat**

The seats can be folded and tilted for more accessibility for passengers to enter and exit the third row.

1. Without a child seat installed, you can fold the seat by pulling the recliner handle on the bottom part of the seat. Before pulling the recliner lever, make sure the arm rests are folded up.

**Recliner Lever**

2. To put it back into position, pull back on the folded seat and make sure that it locks into position. Then, pull the seatback toward the back and fold down the arm rests.

**Exit For Third Row Passengers — Stow 'n Go Seats Only**

If the second row is equipped with Stow 'n Go, third row passengers can pull on the strap and push the seat forward for folding the seatback down and tilting the seat to the floor for an easy exit.

**Pull Strap For Third Row Passengers****NOTE:**

This process is for when there is no child seat installed. Use the easy entry lever if a child seat is installed.

**Second Row Removable Quad Seat**

The second row quad seats, not equipped with the Stow 'n Go feature, are removable for added cargo space.

**Removing Seat**

1. Adjust seat to the full rearward position.
2. Lift the recline lever to fold the seatback flat against the seat cushion.

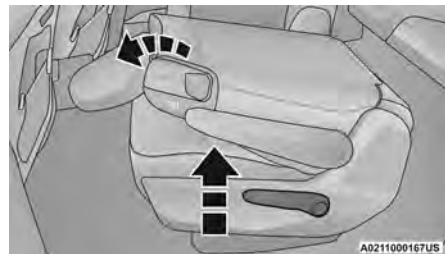
**Lift Recline Lever And Fold Seatback Flat****NOTE:**

Push downward on the seatback to make sure it is in the locked position.

3. The release strap is located on the front of the seat, near the floor.

**Seat Release Strap**

4. To remove the seat, pull the release strap to release the rear latches.
5. Tilt the back of the seat to the upward position.

**Tilt Seat Forward**

6. The seat assembly can now be removed from the vehicle. Grab the front seatback edge located near the head restraint and the grab the bar on the rear side of the seat cushion for easy removal.

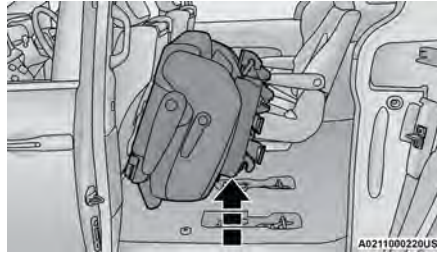
**Seat Removal****Reinstalling Seat**

1. To reinstall the seat: With the seat tilted forward, align the seat's front attachments into the detent positions on the floor.

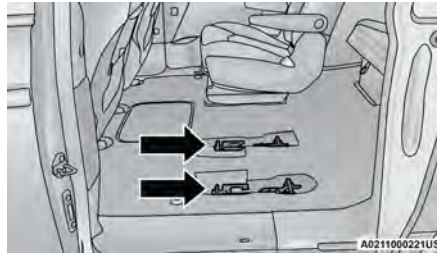
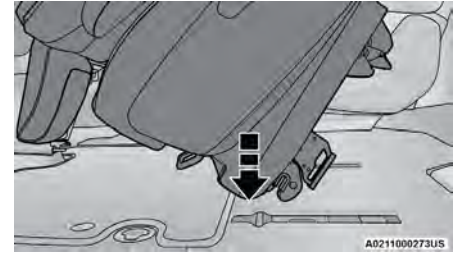
**In Floor Seat Detents****Installing Seat**

2. Tilt seat rearward to lock the seat back into its original position.

**NOTE:**

Push downward to ensure the rear latches are in the locked position.

3. Lift the recline handle and return the seat back to the seating position.

**WARNING!**

If not properly latched, the seat could become loose. Personal injuries could result.

## Manually Folding Third Row Seats — If Equipped

### NOTE:

- You may experience deformation in the seat cushion from the seat belt buckles, or wrinkling of the seat fabric if the seats are left folded for an extended period of time. This is normal and by simply unfolding the seats to the open position, over time the seat cushion may return to its normal shape. Having an occupant sit in the seat, or massaging the fabric by hand may smooth away any excess wrinkling.
- Permanent wrinkles may still result.

- Lower the center head restraint down to the seatback by pushing the button on the guide and pushing the head restraint down.
- Pull release strap marked “1” to release the anchors.

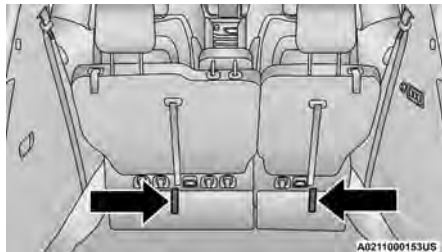

Release Strap “1”

- Pull release strap marked “2” and tumble the seat rearward into the storage bin.

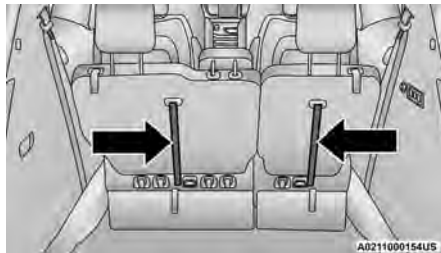

Strap “2”

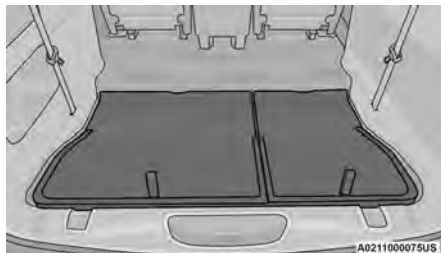

Stowed Third Row Seat

## To Unfold Third Row Seats

- Pull up on the assist strap to lift the seat out of the storage bin and push the seat forward until the anchors latch.

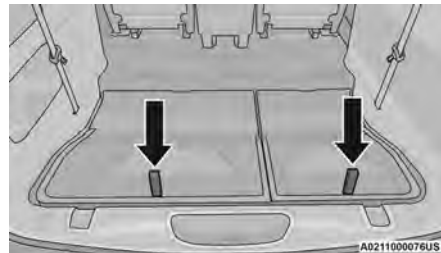

Assist Straps

- Pulling strap “2” releases the seatback to return to its full upright position.

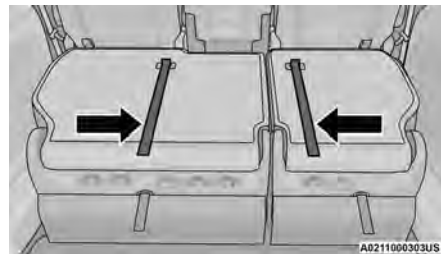

Strap “2”

- Raise the head restraint to its upright position.

**WARNING!**

- In a collision, you or others in your vehicle could be injured if seats are not properly latched to their floor attachments. Always be sure the seats are fully latched.
- Sitting in a seat with the head restraint in its lowered position could result in serious injury or death in a collision. Always make sure the head restraints are in their upright positions when the seat is to be occupied.

**Stow 'n Go Seating**

On vehicles equipped with Stow 'n Go seating, the second and third row seats can be folded into the floor for convenient storage.

**AUTO ADVANCE 'n RETURN — IF EQUIPPED**

On vehicles equipped with the Auto Advance 'n Return feature, the front seat will move forward automatically to a location that will allow the second row Stow 'n Go seat movement, without interference by the front seat. After the second row seat is stowed, the front seat will move back to the previous location once the Auto Advance 'n Return button is pushed again.

The Auto Advance 'n Return feature is available to both the front driver and passenger power seats (if equipped).

**WARNING!**

During power seat operation, personal injury or cargo damage may occur. Ensure the front seat is not occupied and the seat travel path is clear when operating the power seat.

A one-touch Auto Advance 'n Return button is located on the B-pillar trim panel, just in front of the power sliding door.

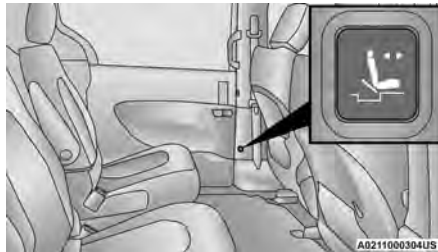

**Auto Advance 'n Return Button (Left Side Shown)**

**Using the Auto Advance 'n Return Feature****NOTE:**

- The button is only functional when the power sliding door is open and the vehicle is in PARK. If the door is not open or the vehicle is not in PARK when the button is pushed, the front seat will not move and a message will be displayed in the instrument cluster display.
- If the power sliding door is closing when the button is pushed, the front seat will not move and a message will be displayed in the instrument cluster display.
- The Auto Advance 'n Return feature will not function if the front doors are open.

1. Push and release the Auto Advance 'n Return button.
2. Perform the second row Stow 'n Go seat movement  page 46.
3. Push and release the Auto Advance 'n Return button a second time. The front seat cushion and seatback will return to the original starting location.

**NOTE:**

- To abort seat operation while seat is in motion, push the Auto Advance 'n Return button, or push the front power seat button to stop the seat movement. Pushing the Auto Advance 'n Return button again will return the front seat to the original starting location.
- The Auto Advance 'n Return system includes obstacle detection. When the system detects an obstacle, the seat will stop, reverse direction, and return to the previous location. A message will be displayed in the instrument cluster indicating that an obstacle has been detected.
- If the front seat is already in a location that will allow space for Stow 'n Go of the second row seat, the front seat will not move and a message will be displayed in the instrument cluster.
- If calibration of the front seat is lost, the seat will automatically recalibrate when the Auto Advance 'n Return button is pushed. This may result in the seat cushion moving forward and downward, before moving to the location that will allow space for the second row Stow 'n Go seat movement.

## SECOND ROW STOW 'N GO

**For Manual Seats:** To stow the seat in the floor, move the front seat all the way forward using the manual seat adjustment bar. Move the seatback all the way forward using the recliner handle located on the outboard side of the cushion. Move the seat height to at least mid position using the height adjuster handle in the outboard side of the cushion.

**For Power Seats:** Push the Auto Advance 'n Return button located on the B-pillar trim (if equipped) ↪ page 45.

1. To access the storage area, remove the floor mat (if equipped) and place the lock rod in the locked position.

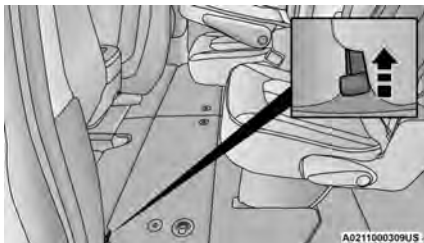

**Lock Rod**

### NOTE:

- Push the lock rod inward for the unlocked position.
- Pull outward on the lock rod for the locked position.
- For information on storage bin function with the seats rearward ↪ page 78.

2. Pull the latch located near the second row seat to open the floor panel.

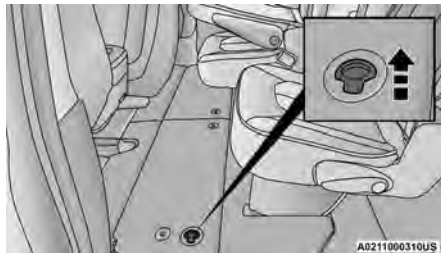

**Floor Latch**

3. Pull the floor panel and position it toward the front seats while folding the top half down, and rest it against the front seats.



**Push Panel Forward**

4. Remove the plastic storage bin (if equipped) from the storage area, and store in a safe location.

5. Fold the armrest upward and stow the seat by grabbing the strap on the lower part of the seatback, and guide the seat into the storage area.

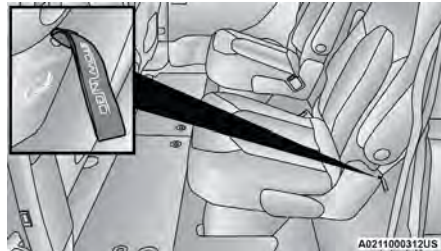

**Pull Strap**

6. Push down on the seatback to lock the seat into the storage area.

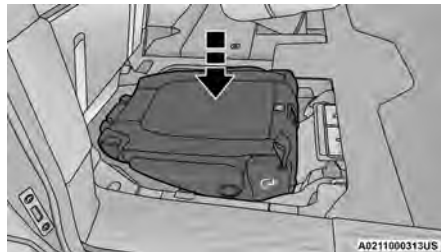

**Push To Lock**



7. Close the floor by pulling the floor panel backwards by the bottom corner edge of the panel.



**Extend Floor Panel**

8. Push down on floor panel to lock into place.

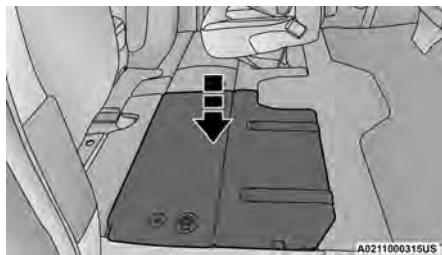

**Push To Lock**

9. Readjust the front seat as needed, and replace the floor mat (if equipped).

**WARNING!**

In a collision, serious injury could result if the seat storage bin covers are not properly latched:

- Do not drive the vehicle with the storage bin covers open.
- Keep the storage bin covers closed and latched while the vehicle is in motion.
- Do not use a storage bin latch as a tie down.

**CAUTION!**

- The storage bin cover must be latched and flat to avoid damage from contact with the front seat tracks, which have minimal clearance to the cover.
- Do not sit on the second row seat when it is in the stowed position with the seatback upright otherwise damage to the seat may occur.

**TO UNSTOW SECOND ROW SEATS**

**For Manual Seats:** To unstow the seat from the floor, move the front seat all the way forward using the manual seat adjustment bar.

**For Power Seats:** Push the Auto Advance 'n Return button located on the B-pillar trim (if equipped)

↩ page 45.

1. To access the storage area, remove the floor mat (if equipped) and place the lock rod in the unlocked position.

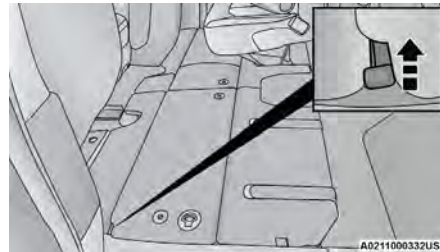

**Lock Rod**

**NOTE:**

- Push the lock rod inward for the unlocked position.
- Pull outward on the lock rod for the locked position.

2. Pull the latch located near the second row seat to open the floor panel.

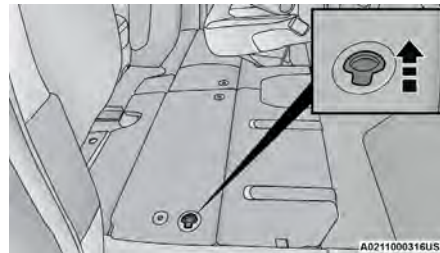

**Floor Latch**

3. Pull the floor panel and position it toward the front seats while folding the top half down and rest it against the front seats.

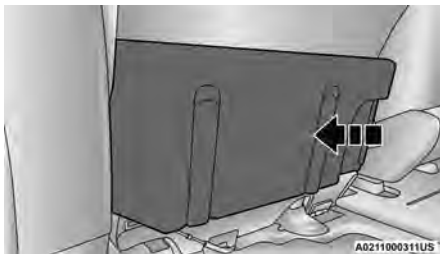

**Push Panel Forward**

4. Pull the strap located on the seat and pull the seat out of the storage area. Push the seat rearward making sure that it locks into the floor. Fold the seatback into the upright position and pull the headrest up.

**NOTE:**

If the seatback is locked, it will be necessary to use the recliner handle to unlock the back before folding into the upright position.

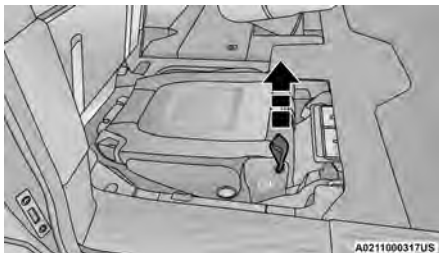

**Pull Strap**

5. Replace the plastic storage bin into the storage area.
6. To position the floor panel back into its original state, grab the bottom corner and extend it outward.

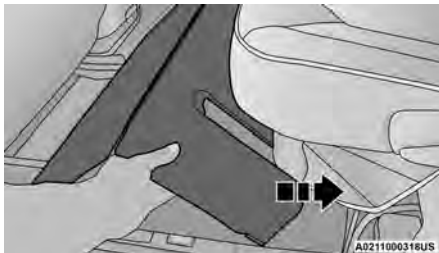

**Extend Panel**

7. Lay the floor panel flat and push down until it clicks into position.

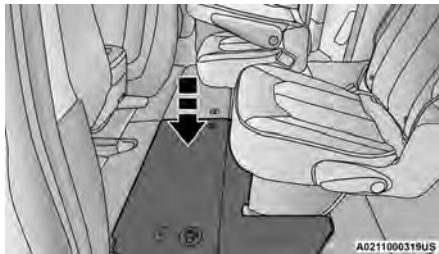

**Push Down To Lock**

8. Readjust the front seat as needed, and replace the floor mat (if equipped).

**WARNING!**

- In a collision, you or others in your vehicle could be injured if seats are not properly latched to their floor attachments. Always be sure the seats are fully latched.
- Sitting in a seat with the head restraint in its lowered position could result in serious injury or death in a collision. Always make sure the head restraints are in their upright positions when the seat is to be occupied.

## POWER ADJUSTMENT FRONT SEATS — IF EQUIPPED

Some models may be equipped with eight-way power seats for the driver and front passenger. The power seat switches are located on the outboard side of the seat. The switches control the movement of the seat cushion and the seatback.

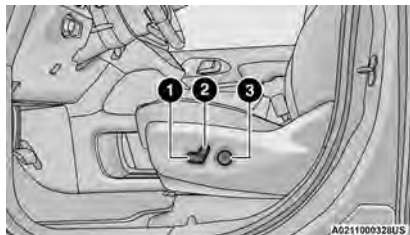

**Driver Power Seat Switches**

- 1 — Seat Switch
- 2 — Seatback Switch
- 3 — Lumbar Switch

### WARNING!

- Adjusting a seat while driving may be dangerous. Moving a seat while driving could result in loss of control which could cause a collision and serious injury or death.
- Seats should be adjusted before fastening the seat belts and while the vehicle is parked. Serious injury or death could result from a poorly adjusted seat belt.

*(Continued)*

### WARNING!

- Do not ride with the seatback reclined so that the shoulder belt is no longer resting against your chest. In a collision you could slide under the seat belt, which could result in serious injury or death.

### CAUTION!

Do not place any article under a power seat or impede its ability to move as it may cause damage to the seat controls. Seat travel may become limited if movement is stopped by an obstruction in the seat's path.

## Adjusting The Seat Forward Or Rearward

The seat can be adjusted both forward and rearward by using the seat switch. The seat will move in the direction of the switch. Release the switch when the desired position has been reached.

## Adjusting The Seat Up Or Down

The height of the seats can be adjusted up or down. Pull upward or push downward on the rear of seat switch, the seat will move in the direction of the switch. Release the switch when the desired position has been reached.

## Tilting The Seat Up Or Down

The angle of the seat cushion can be adjusted in two directions. Pull upward or push downward on the front of the seat switch, the front of the seat cushion will move in the direction of the switch. Release the switch when the desired position has been reached.

## Reclining The Seatback

The angle of the seatback can be adjusted forward or rearward. Push the seatback switch forward or rearward, the seat will move in the direction of the switch. Release the switch when the desired position is reached.

### WARNING!

- Adjusting a seat while driving may be dangerous. Moving a seat while driving could result in loss of control which could cause a collision and serious injury or death.
- Seats should be adjusted before fastening the seat belts and while the vehicle is parked. Serious injury or death could result from a poorly adjusted seat belt.
- Do not ride with the seatback reclined so that the shoulder belt is no longer resting against your chest. In a collision you could slide under the seat belt, which could result in serious injury or death.

### CAUTION!

Do not place any article under a power seat or impede its ability to move as it may cause damage to the seat controls. Seat travel may become limited if movement is stopped by an obstruction in the seat's path.

## Power Lumbar — If Equipped

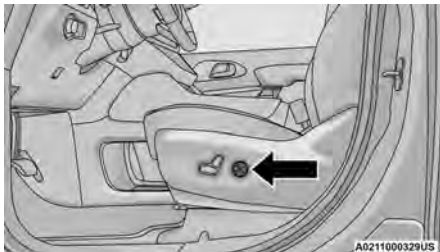

**Power Lumbar Switch Location**

The front driver's seat may be equipped with a four way lumbar adjustment. The power lumbar switch is located on the outboard side of the equipped power seat. Push the switch forward or rearward to increase or decrease the lumbar support. Push the switch upward or downward to raise or lower the lumbar support.

The front passenger's seat may be equipped with either a two way or a four way lumbar adjustment. Push the switch forward or rearward to increase or decrease the lumbar support, and if equipped, push the switch upward or downward to raise or lower the lumbar support.

## Easy Entry/Exit Seat — If Equipped

This feature provides automatic driver seat positioning to enhance driver mobility when entering and exiting the vehicle.

The distance the driver seat moves depends on where you have the driver seat positioned when you place the vehicle's ignition in the OFF position.

- When the ignition is placed in the OFF position, the driver seat will move about 2.4 inches (6.8 cm) rearward if the driver seat position is greater than or equal to 2.7 inches (6 cm) forward of the rear stop. The seat will return to its previously set position when the ignition is cycled out of the OFF position.
- When the ignition is placed in the OFF position, the driver seat will move to a position 0.3 inches (0.7 cm) forward of the rear stop if the driver seat position is between 0.9 – 2.7 inches (2.3 – 6.8 cm) forward of the rear stop. The seat will return to its previously set position when the ignition is cycled out of the OFF position.
- The Easy Entry/Easy Exit feature is disabled when the driver seat position is less than 0.9 inches (2.3 cm) forward of the rear stop. At this position, there is no benefit to the driver by moving the seat for Easy Exit or Easy Entry.

When enabled within Uconnect Settings, Easy Entry and Easy Exit positions are stored in each memory setting profile (if equipped) ↗ page 37.

### NOTE:

The Easy Entry/Exit feature is enabled or disabled within the Uconnect system ↗ page 169.

## POWER ADJUSTMENT REAR SEATS — IF EQUIPPED

### WARNING!

- Adjusting a seat while driving may be dangerous. Moving a seat while driving could result in loss of control which could cause a collision and serious injury or death.

*(Continued)*

### WARNING!

- Seats should be adjusted before fastening the seat belts and while the vehicle is parked. Serious injury or death could result from a poorly adjusted seat belt.
- Do not ride with the seatback reclined so that the shoulder belt is no longer resting against your chest. In a collision you could slide under the seat belt, which could result in serious injury or death.
- Do not place the seat belt webbing behind the third row stow clip when using the seat belt to restrain an occupant. The seat belt will not be positioned properly on the occupant and they could be more seriously injured in an accident as a result.

### CAUTION!

Do not place any article under a power seat or impede its ability to move as it may cause damage to the seat controls. Seat travel may become limited if movement is stopped by an obstruction in the seat's path.

## Third Row Power Recline — If Equipped

The power recline feature, located on the trim panel next to the seat, adjusts the seatback angle forward/rearward for occupant comfort.

### Reclining The Seatback

The angle of the seatback can be adjusted forward or rearward. Push and hold the forward or rearward button, the seat will move in the direction of the button push. Release the button when the desired position is reached.

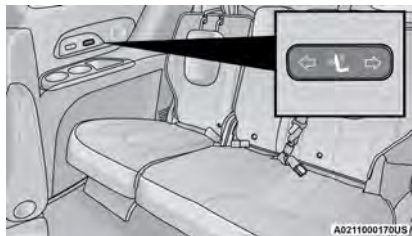

**Third Row Power Seat Switch**

**NOTE:**

The third row power recline buttons can be locked out using the Third Row Lockout setting within the Uconnect system → page 169.

**Third Row Power Stow 'n Go Seat — If Equipped**

A one-touch power folding seat switch is located in the right rear trim panel as part of a switch bank.

**NOTE:**

The third row outboard seat belts may interfere with the power folding of the seat. Place the seat belt webbing behind the stow clip before stowing or opening the seat. When the seat is in the desired position, remove the webbing from the stow clip so that it is ready for use. Never leave the seat belt in the stow clip when it is used to restrain an occupant.

**NOTE:**

- The outer head restraints will lower automatically as necessary when the power seat begins to move.
- The center head restraint raises and lowers manually but will not lower automatically.
- The head restraint can also be lowered manually using the pull strap located at the back of the seat → page 55.

The switch is only functional when the liftgate is open and the vehicle is in PARK.

The rear switch bank allows multiple power folding and unfolding positions for the third row seats.

Left and right third row seats can be folded individually or together. The third row power folding seat adjusts to the following positions using the switch bank located on the left rear trim panel:

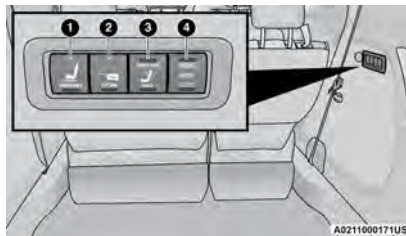

**Rear Panel Power Switch Bank**

- 1 — Open To Normal
- 2 — Stow
- 3 — Fold Forward/Rearward
- 4 — Right/Left Seats/Both Seats

To move the selected seat(s) to the normal (seated) position, push and release the “Normal” button. The seat will automatically stop when the Normal position is reached.

To move the selected seat(s) to the stow position, push and release the “Stow” button. The seat will automatically stop when the Stow position is reached.

To move the selected seat(s) back in the forward or reverse direction, push and hold the “Fold Forward/Back” button. Release the button when the desired position is reached.

1. Disconnect the center shoulder belt from the mini-buckle before attempting to fold/stow the power third row seats.
2. Before pushing the “Normal” or “Stow” button, place the outboard seat belt webbing behind the stow clips, located on the rear trim panel. When the seat reaches the desired position, remove the webbing from the clip so it is ready for use to restrain an occupant.

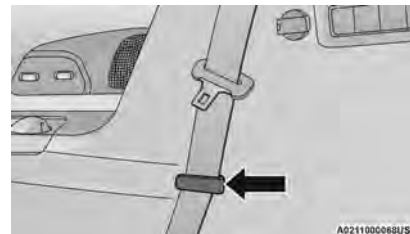

**Seat Belt Stowage Clip**

- To abort seat operation while seat is in motion, push a different seat position selector switch to stop the seat. Once the seat stops moving, then the desired position can be selected.
- The third row power seat system includes obstacle detection. When the system detects an obstacle, the motors will stop and reverse direction. Should this occur, remove the obstacle before pushing the button again.

**NOTE:**

- You may experience deformation in the seat cushion from the seat belt buckles, or wrinkling of the seat fabric if the seats are left folded for an extended period of time. This is normal and by simply unfolding the seats to the open position, over time the seat cushion may return to its normal shape. Having an occupant sit in the seat, or massaging the fabric by hand may smooth away any excess wrinkling.
- Permanent wrinkles may still result.

**HEATED SEATS****Front Heated Seats — If Equipped**

The front heated seats control buttons are located in the touchscreen.

You can choose from HI, LO or off heat settings. The indicator lights in each switch indicate the level of heat in use. Two indicator lights will illuminate for HI, one for LO and none for off.

- Press the heated seat button once to turn the HI setting on.
- Press the heated seat button a second time to turn the LO setting on.

- Press the heated seat button a third time to turn the heating elements off.

The level of heat selected will stay on until the operator changes it.

**NOTE:**

- Once a heat setting is selected, heat will be felt within two to five minutes.
- The engine must be running for the heated seats to operate.

For information on use with the Remote Start system, see page 26.

**WARNING!**

- Persons who are unable to feel pain to the skin because of advanced age, chronic illness, diabetes, spinal cord injury, medication, alcohol use, exhaustion or other physical condition must exercise care when using the seat heater. It may cause burns even at low temperatures, especially if used for long periods of time.
- Do not place anything on the seat or seatback that insulates against heat, such as a blanket or cushion. This may cause the seat heater to overheat. Sitting in a seat that has been overheated could cause serious burns due to the increased surface temperature of the seat.

**Rear Heated Seats — If Equipped**

On some models, the second row seats are equipped with heaters. There are two heated seat switches that allow the second row passengers to operate the seats independently. The heated seat switches are located on the sliding side door handle trim panels.

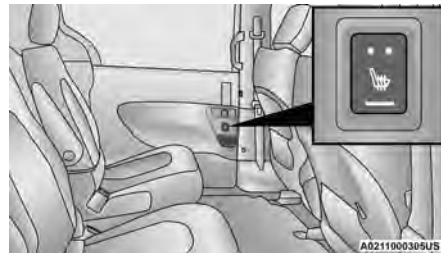
**Second Row Heated Seat Switch (Left Side Shown)**

You can choose from HI, LO or off heat settings. Amber indicator lights in each switch indicate the level of heat in use. Two indicator lights will illuminate for HI, one for LO and none for off.

Push the switch once to select HI-level heating. Push the switch a second time to select LO-level heating. Push the switch a third time to shut the heating elements off.

**NOTE:**

Once a heat setting is selected, heat will be felt within two to five minutes.

When the HI-level setting is selected, the heater will provide a boosted heat level during the initial stages of operation. Then, the heat output will drop to the normal HI-level. The level of heat selected will stay on until the operator changes it.

## VENTILATED SEATS — IF EQUIPPED



Located in the first row seat cushions are small fans that draw the air from the passenger compartment and move air through fine perforations in the seat cover to help keep the driver and front passenger cooler in higher ambient temperatures. The fans operate at two speeds: HI and LO.

The front ventilated seats control buttons are located in the touchscreen.

- Press the ventilated seat button once to choose HI.
- Press the ventilated seat button a second time to choose LO.
- Press the ventilated seat button a third time to turn the ventilated seat off.

### NOTE:

The engine must be running for the ventilated seats to operate.

For information on use with the Remote Start system, see page 26.

## PLASTIC GROCERY BAG RETAINER HOOKS

Retainer hooks which will hold plastic grocery bag handles are built into the seatbacks of the second row rear seats, and if equipped, the backs of the front row seats. The floor supports the partial weight of the bagged goods.

## HEAD RESTRAINTS

Head restraints are designed to reduce the risk of injury by restricting head movement in the event of a rear impact. Head restraints should be adjusted so that the top of the head restraint is located above the top of your ear.

### WARNING!

- All occupants, including the driver, should not operate a vehicle or sit in a vehicle's seat until the head restraints are placed in their proper positions in order to minimize the risk of neck injury in the event of a crash.
- Head restraints should never be adjusted while the vehicle is in motion. Driving a vehicle with the head restraints improperly adjusted or removed could cause serious injury or death in the event of a collision.

## Head Restraints — Front Seats

The front driver and passenger seats are equipped with four-way head restraints.

To raise the head restraint, pull upward on the head restraint. To lower the head restraint, push the adjustment button, located at the base of the head restraint, and push downward. The front head restraints are also adjustable forward and rearward. To tilt forward, pull the top of the head restraint toward the front of the vehicle to the desired position. To adjust the head restraint rearward, continue pulling forward on the top of the head restraint to the farthest forward position and the head restraint will return to the upright position.

### NOTE:

To remove the head restraint, raise it as far as it can go. Then, push the release button and the adjustment button at the base of each post while pulling the head restraint up. Seatback angle may need to be adjusted to fully remove the head restraint. To reinstall the head restraint, put the head restraint posts into the holes and push downward. Then, adjust the head restraint to the appropriate height.

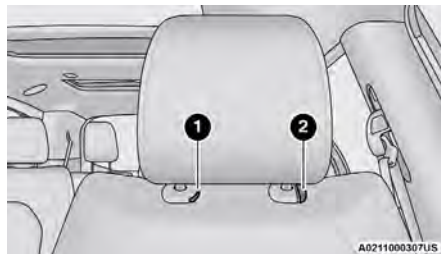

Front Head Restraint

- 1 — Release Button  
2 — Adjustment Button



Normal Position



Forward Adjustment

**WARNING!**

- A loose head restraint thrown forward in a collision or hard stop could cause serious injury or death to occupants of the vehicle. Always securely stow removed head restraints in a location outside the occupant compartment.

(Continued)

**WARNING!**

- ALL the head restraints **MUST** be reinstalled in the vehicle to properly protect the occupants. Follow the reinstallation instructions prior to operating the vehicle or occupying a seat.

**Head Restraints — Second Row Quad Seats**

The second row outboard head restraints, as well as the removable 8th passenger seat (if equipped), may have adjustable head restraints.

**NOTE:**

If equipped with Stow 'n Go seating, the head restraints are non-adjustable and non-removable. **Do not** pull on non-adjustable head restraints when folding the seat.

To raise the head restraint, pull upward on the head restraint. To lower the head restraint, push the adjustment button, located at the base of the head restraint, and push downward.

To remove the head restraint, raise it as far as it can go. Then, push the release button and the adjustment button at the base of each post while pulling the head restraint up. Seatback angle may need to be adjusted to fully remove the head restraint. To reinstall the head restraint, put the head restraint posts into the holes and push downward. Then, adjust the head restraint to the appropriate height.

**Head Restraints — Third Row**

The outboard head restraints can be manually folded forward for improved rearward visibility. Pull the release strap to fold them forward.

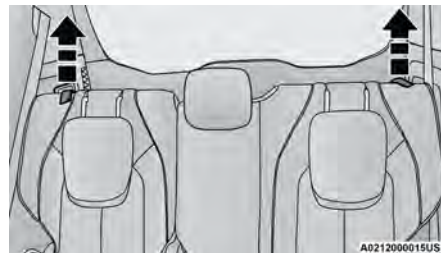

Release Straps

**NOTE:**

- The head restraints must be raised manually when occupying the third row.
- Do not fold if there are passengers seated in the third row seats.

The head restraint in the center position can be raised and lowered for tether routing or height adjustment  
 ⇨ page 207.

**NOTE:**

To remove the center head restraint, raise it as far as it can go. Then, push the release button and the adjustment button at the base of each post while pulling the head restraint up. To reinstall the head restraint, put the head restraint posts into the holes and push downward. Then, using the adjustment button, adjust the head restraint to the appropriate height.



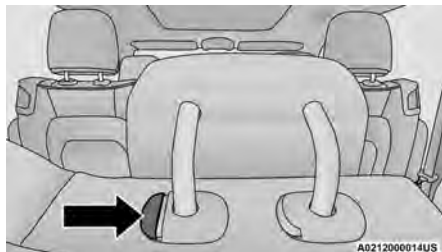

Adjustment Button

**WARNING!**

ALL the head restraints **MUST** be reinstalled in the vehicle to properly protect the occupants. Follow the re-installation instructions prior to operating the vehicle or occupying a seat.

## POWER FOLDING THIRD ROW HEAD RESTRAINTS — IF EQUIPPED

For improved visibility, the third row outboard head restraints can be folded using the Uconnect system.

Press Vehicle, then Controls located on the bottom of the Uconnect display.



Press the Head Restraint Fold button to power fold the third row head restraints.

**NOTE:**

- The head restraints can be folded downward using the Head Restraint button or using the manual release strap. The head restraints must be raised manually when occupying the third row.
- Do not fold if there are passengers seated in the third row seats.

## Uconnect Voice Recognition — If Equipped

### INTRODUCING VOICE RECOGNITION

Start using Uconnect Voice Recognition (VR) with these helpful quick tips. It provides the key Voice Commands and tips you need to know to control your system.

### BASIC VOICE COMMANDS

The following basic Voice Commands can be given at any point while using your Uconnect system.

Push the VR button on the steering wheel. After the beep, say:

- **“Cancel”** to stop a current voice session.
- **“Help”** to hear a list of suggested Voice Commands.
- **“Repeat”** to listen to the system prompts again.

Notice the visual cues that inform you of your Voice Recognition system’s status.

Use this QR code to access your digital experience.



2

## GET STARTED

The VR button is used to activate/deactivate your Voice Recognition system.

Helpful hints for using Voice Recognition:

- Reduce background noise. Wind noise and passenger conversations are examples of noise that may impact recognition.
- Speak clearly at a normal pace and volume while facing straight ahead.
- Each time you give a Voice Command, first push the VR button, wait until after the beep, then say your Voice Command. You can also say the vehicle “Wake Up” word and state your command.

**NOTE:**

The factory default Wake Up word is set to “Hey Uconnect” and can be reprogrammed through the Uconnect Settings. After the beep, say:

- A passenger can press the VR button shortcut on the radio status bar to also issue a command.
- You can interrupt the help message or system prompts by pushing the VR button and saying a Voice Command or saying the vehicle’s “Wake Up” word and saying a command from the current category.

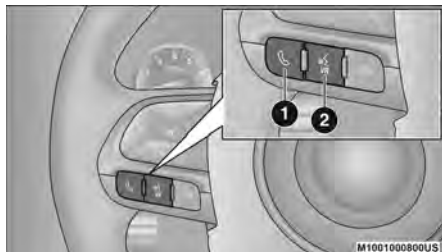

### Uconnect Voice Command Buttons

- 1 – Push To Answer An Incoming Phone Call  
 2 – For Vehicles Equipped With Navigation: Push The Voice Recognition Button To Begin Radio, Media, Navigation, Climate, Start Or Answer A Phone Call, And Send Or Receive A Text  
 2 – For Vehicles Not Equipped With Navigation: Push The Phone Button To Answer An Incoming Phone Call

### ADDITIONAL INFORMATION

© 2023 FCA US LLC. All rights reserved. Mopar and Uconnect are registered trademarks and Mopar Owner Connect is a trademark of FCA US LLC. SiriusXM® and all related marks and logos are trademarks of SiriusXM® Radio Inc. ↩ page 318.

For Uconnect system support, call 1-877-855-8400 (24 hours a day 7 days a week) or visit [DriveUconnect.com](http://DriveUconnect.com) (US) or [DriveUconnect.ca](http://DriveUconnect.ca) (Canada).

## MIRRORS

### INSIDE REARVIEW MIRROR

#### Manual Mirror — If Equipped

A single ball joint mirror is used to allow the driver to adjust up, down and left, right. The mirror should be adjusted to center on the view through the rear window.

Headlight glare can be reduced by moving the small control under the mirror to the night position (toward the rear of the vehicle). The mirror should be adjusted while set in the day position (toward the windshield).



Manual Rearview Mirror

#### Automatic Dimming Mirror — If Equipped

The mirror head can be adjusted up, down, left, and right. The mirror should be adjusted to center on the view through the rear window.

This mirror automatically adjusts for headlight glare from vehicles behind you.

#### NOTE:

The Automatic Dimming Mirror feature is disabled when the vehicle is in REVERSE to improve the driver's view.

You can turn the feature on or off through the Uconnect system ↩ page 169.



Automatic Dimming Mirror

#### CAUTION!

To avoid damage to the mirror during cleaning, never spray any cleaning solution directly onto the mirror. Apply the solution onto a clean cloth and wipe the mirror clean.

## ILLUMINATED VANITY MIRRORS — IF EQUIPPED

To access an illuminated vanity mirror, flip down one of the visors and lift the cover.

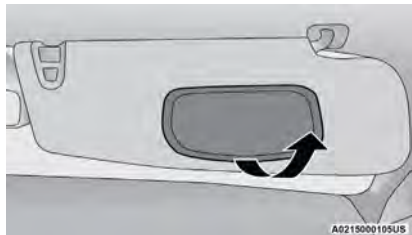

**Illuminated Mirror**

## OUTSIDE MIRRORS

The outside mirror(s) can be adjusted to the center of the adjacent lane of traffic to achieve the optimal view.

### WARNING!

Vehicles and other objects seen in an outside convex mirror will look smaller and farther away than they really are. Relying too much on side convex mirrors could cause you to collide with another vehicle or other object. Use your inside mirror when judging the size or distance of a vehicle seen in a side convex mirror.

## OUTSIDE MIRRORS WITH TURN SIGNAL AND APPROACH LIGHTING — IF EQUIPPED

Driver and passenger outside mirrors with turn signal and approach lighting contain four LEDs, which are located in the upper outer corner of each mirror.

Three of the LEDs are turn signal indicators, which flash with the corresponding turn signal lights in the front and rear of the vehicle. Turning on the Hazard Warning flashers will also activate these LEDs.

The fourth LED supplies illuminated entry lighting, which turns on in both mirrors when you use the key fob or open any door. This LED shines outward to illuminate the front and rear door handles. It also shines downward to illuminate the area in front of the doors.

The illuminated entry lighting fades to off after about 30 seconds or it will fade to off immediately once the ignition is placed into the ON/RUN position.

### NOTE:

The approach lighting will not function when the gear selector is moved out of the PARK position.

## DRIVER'S OUTSIDE AUTOMATIC DIMMING MIRROR — IF EQUIPPED

The driver's outside mirror will automatically adjust for glare from vehicles behind you. This feature is controlled by the inside automatic dimming mirror and will automatically adjust for headlight glare when the inside mirror adjusts.

## CONVERSATION MIRROR

Located in the overhead console there is a conversation mirror to view all the passengers in the vehicle. Push the panel to release the drop down mirror. Raise the mirror and push to latch it back in the stowed position.

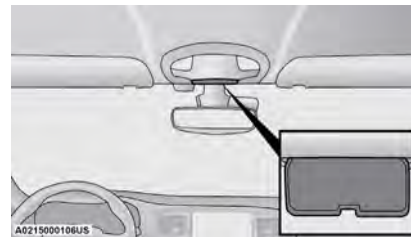

**Conversation Mirror**

## POWER MIRRORS — IF EQUIPPED

The power mirror controls are located on the driver-side door trim panel.

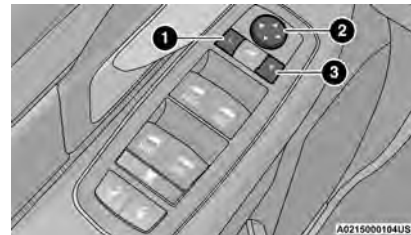

**Power Mirror Controls**

- 1 — Left Mirror Select
- 2 — Mirror Control Switch
- 3 — Right Mirror Select

The power mirror controls consist of mirror select buttons and a four-way mirror control switch. To adjust a mirror, push either the L (left) or R (right) to select the mirror that you want to adjust.

**NOTE:**

A light in the selected button will illuminate indicating the mirror is activated and can be adjusted.

Using the mirror control switch, push on any of the four arrows for the direction that you want the mirror to move.

Left and Right side power mirror positions can be saved as part of the driver memory profile (if equipped)

↪ page 37.

## POWER FOLDING OUTSIDE MIRRORS — IF EQUIPPED

The switch for the power folding mirrors is located between the power mirror switches L (left) and R (right). Push the switch once and the mirrors will fold in, pushing the switch a second time will return the mirrors to the normal driving position.

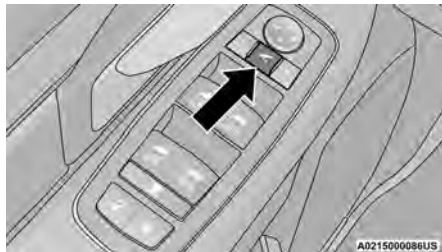

**Power Folding Mirror Switch**

**NOTE:**

If the vehicle speed is greater than 10 mph (16 km/h), the folding feature will be disabled.

If the mirrors are in the folded position, and vehicle speed is equal to or greater than 10 mph (16 km/h), they will automatically unfold.

**Resetting The Power Folding Outside Mirrors**

You may need to reset the power folding mirrors if the following occurs:

- The mirrors are accidentally blocked while folding
- The mirrors are accidentally manually folded/unfolded (by hand or by pushing the power folding mirror switch)
- The mirrors come out of the unfolded position
- The mirrors shake and vibrate at normal driving speeds

To reset the power folding mirrors: fold and unfold them by pushing the button (this may require multiple button pushes). This resets them to their normal position.

## AUTOMATIC POWER FOLDING MIRRORS — IF EQUIPPED

When enabled within Uconnect Settings ↪ page 169, the exterior mirrors will automatically fold when the vehicle's ignition is placed in the OFF position, and after the doors are locked and closed.

The exterior mirrors will auto-fold in the following situations after the ignition is placed in the OFF position:

- Pushing the lock button on the door panel before the door is opened.

**NOTE:**

If the doors are already locked, push the lock button again.

- Opening the door, then pushing the lock button on the door panel, followed by closing the door.
- After exiting the vehicle, close the doors then push the lock button on the key fob.
- After exiting the vehicle, close the doors then touch the lock icon on the Passive Entry door handle.

If the exterior mirrors were folded automatically, they will unfold when the ignition is placed in the ON/RUN position.

**NOTE:**

If the mirrors were folded manually (pushing the mirror head inward by hand), OR by using the power folding mirror switch on the driver's door panel, they will not automatically unfold.

## OUTSIDE MIRRORS FOLDING FEATURE

All outside mirrors are hinged and may be moved either forward or rearward to resist damage. The hinges have two detent positions:

- Full forward position
- Full rearward position

## HEATED MIRRORS — IF EQUIPPED



These mirrors are heated to melt frost or ice. This feature will be activated whenever you turn on the rear window defroster (if equipped) ↪ page 67.

## TILT SIDE MIRRORS IN REVERSE — IF EQUIPPED

Tilt Side Mirrors In Reverse provides automatic outside mirror positioning which will aid the driver's view of the ground rearward of the front doors. The driver's outside mirror will move slightly downward from the present position when the vehicle is shifted into REVERSE. The driver's outside mirror will then return to the original position when the vehicle is shifted out of the REVERSE position. Each stored memory setting will have an associated Tilt Side Mirrors In Reverse position.

### NOTE:

The Tilt Side Mirrors In Reverse feature can be enabled or disabled through the Uconnect system  page 169.

## UNIVERSAL GARAGE DOOR OPENER (HOMELINK®) — IF EQUIPPED

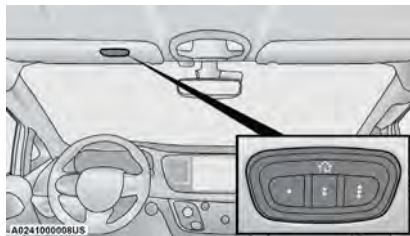

HomeLink® Buttons And Indicator Light

Use this QR code to access your digital experience.



- HomeLink® replaces up to three hand-held transmitters that operate devices such as garage door openers, motorized gates, lighting, or home security systems. The HomeLink® unit is powered by your vehicle's 12 Volt battery.
- The HomeLink® buttons that are located in the overhead console or sun visor designate the three different HomeLink® channels.
- To operate HomeLink®, push and release any of the programmed HomeLink® buttons. These buttons will activate the devices they are programmed to with each press of the corresponding HomeLink® button.
- The HomeLink® indicator light is located above the center button.

### NOTE:

HomeLink® is disabled when the Vehicle Security system is active  page 318.

## BEFORE YOU BEGIN PROGRAMMING HOMELINK®

For efficient programming and accurate transmission of the Radio Frequency (RF) signal, it is recommended that a new battery be placed in the hand-held transmitter of the device that is being programmed to the HomeLink® system. Make sure your hand-held transmitter is programmed to activate the device you are trying to program your HomeLink® button to.

Ensure that your vehicle is parked outside of the garage before you begin programming.

It is recommended that you erase all the channels of your HomeLink® before you use it for the first time.

## ERASING ALL THE HOMELINK® CHANNELS

To erase the channels, follow this procedure:

1. Place the ignition switch in the ON/RUN position.
2. Push and hold the two outside HomeLink® buttons (I and III) for up to 20 seconds, or until the HomeLink® indicator light flashes.

### NOTE:

Erasing all channels should only be performed when programming HomeLink® for the first time. Do not erase channels when programming additional buttons.

## IDENTIFYING WHETHER YOU HAVE A ROLLING CODE OR NON-ROLLING CODE DEVICE

Before programming a device to one of your HomeLink® buttons, you must determine whether the device has a rolling code or non-rolling code.

### Rolling Code Devices

To determine if your device has a rolling code, a good indicator is its manufacturing date. Typically, devices manufactured after 1995 have rolling codes. A device with a rolling code will also have a "LEARN" or "TRAIN" button located where the antenna is attached to the device. The button may not be immediately visible when looking at the device. The name and color of the button may vary slightly by manufacturer.

**NOTE:**

The "LEARN" or "TRAIN" button is not the button you normally use to operate the device.

**Non-rolling Code Devices**

Most devices manufactured before 1995 will not have a rolling code. These devices will also not have a "LEARN" or "TRAIN" button.

## PROGRAMMING HOMELINK® TO A GARAGE DOOR OPENER

To program any of the HomeLink® buttons to activate your garage door opener motor, proceed as follows:

**NOTE:**

All HomeLink® buttons are programmed using this procedure. You do not need to erase all channels when programming additional buttons.

1. Place the ignition switch in the ON/RUN position.
2. Place the garage door opener transmitter 1 to 3 inches (3 to 8 cm) away from the HomeLink® button you wish to program, while keeping the HomeLink® indicator light in view.
3. Push and hold the HomeLink® button you want to program while you push and hold the garage door opener transmitter button you are trying to replicate.
4. Continue to hold both buttons and observe the HomeLink® indicator light. The HomeLink® indicator light will flash slowly and then rapidly. Once this happens, release both buttons.

**NOTE:**

Make sure the garage door opener motor is plugged in before moving on to the rolling code/non-rolling code final steps.

### Rolling Code Garage Door Opener Final Steps

**NOTE:**

You have 30 seconds in which to initiate rolling code final step 2, after completing rolling code final step 1.

1. At the garage door opener motor (in the garage), locate the "LEARN" or "TRAIN" button. This can usually be found where the hanging antenna wire is attached to the garage door opener motor. Firmly push and release the "LEARN" or "TRAIN" button.
2. Return to the vehicle and push the programmed HomeLink® button three times (holding the button for two seconds each time). If the garage door opener motor operates, programming is complete.
3. Push the programmed HomeLink® button to confirm that the garage door opener motor operates. If the garage door opener motor does not operate, repeat the final steps for the rolling code procedure.

### Non-Rolling Code Garage Door Opener Final Steps

1. Push and hold the programmed HomeLink® button and observe the HomeLink® indicator light. If the HomeLink® indicator light stays on constantly, programming is complete.
2. Push the programmed HomeLink® button to confirm that the garage door opener motor operates. If the garage door opener motor does not operate, repeat the steps from the beginning.

**WARNING!**

- Your motorized door or gate will open and close while you are programming the universal transmitter. Do not program the transmitter if people or pets are in the path of the door or gate.

(Continued)

**WARNING!**

- Do not run your vehicle in a closed garage or confined area while programming the transmitter. Exhaust gas from your vehicle contains carbon monoxide which is odorless and colorless. Carbon monoxide is poisonous when inhaled and can cause you and others to be severely injured or killed.

## PROGRAMMING HOMELINK® TO A MISCELLANEOUS DEVICE

The procedure on how to program HomeLink® to a miscellaneous device follows the same procedure as programming to a garage door opener ↪ page 60. Be sure to determine if the device has a rolling code or non-rolling code before beginning the programming process.

**NOTE:**

Canadian Radio Frequency (RF) laws require transmitter signals to time-out (or quit) after several seconds of transmission, which may not be long enough for HomeLink® to pick up the signal during programming. Similar to this Canadian law, some U.S. gate operators are designed to time-out in the same manner. The procedure may need to be performed multiple times to successfully pair the device to your HomeLink® buttons.

## REPROGRAMMING A SINGLE HOMELINK® BUTTON

To reprogram a single HomeLink® button that has been previously trained, without erasing all the channels, proceed as follows. Be sure to determine whether the new device you want to program the HomeLink® button to has a rolling code, or non-rolling code.

1. Place the ignition in the ON/RUN position, without starting the engine.
2. Push and hold the desired HomeLink® button until the HomeLink® indicator light begins to flash after 20 seconds. **Do not release the button.**
3. **Without releasing the button**, proceed with Step 2 in "Programming HomeLink® To A Garage Door Opener" and follow all remaining steps.

## CANADIAN/GATE OPERATOR PROGRAMMING

For programming transmitters in Canada/United States that require the transmitter signals to "time-out" after several seconds of transmission:

Canadian Radio Frequency (RF) laws require transmitter signals to time-out (or quit) after several seconds of transmission, which may not be long enough for HomeLink® to pick up the signal during programming. Similar to this Canadian law, some U.S. gate operators are designed to time-out in the same manner.

It may be helpful to unplug the device during the cycling process to prevent possible overheating of the garage door or gate motor.

1. Place the ignition in the ON/RUN position.

### NOTE:

For vehicles equipped with Keyless Enter 'n Go™, place the ignition in the RUN position. Make sure while programming HomeLink® with the engine on that your vehicle is outside of your garage, or that the garage door remains open at all times.

2. Place the hand-held transmitter 1 to 3 inches (3 to 8 cm) away from the HomeLink® button you wish to program while keeping the HomeLink® indicator light in view.
3. Continue to push and hold the HomeLink® button while you push and release (cycle) your hand-held transmitter every two seconds until HomeLink® has successfully accepted the frequency signal. The indicator light will flash slowly and then rapidly when fully trained.
4. Watch for the HomeLink® indicator to change flash rates. When it changes, it is programmed. It may take up to 30 seconds or longer in rare cases. The garage door may open and close while you are programming.
5. Push and hold the programmed HomeLink® button and observe the indicator light.

### NOTE:

- If the indicator light stays on constantly, programming is complete and the garage door/device should activate when the HomeLink® button is pushed.
- To program the two remaining HomeLink® buttons, repeat each step for each remaining button. **DO NOT** erase the channels.

If you unplugged the garage door opener/device for programming, plug it back in at this time.

## Reprogramming A Single HomeLink® Button (Canadian/Gate Operator)

To reprogram a channel that has been previously trained, follow these steps:

1. Place the ignition in the ON/RUN position.
2. Press and hold the desired HomeLink® button until the indicator light begins to flash after 20 seconds. Do not release the button.
3. Without releasing the button, proceed with "Canadian/Gate Operator Programming" Step 2 and follow all remaining steps.

## SECURITY

It is advised to erase all channels before you sell or turn in your vehicle.

To do this, push and hold the two outside buttons for 20 seconds until the indicator flashes. Note that all channels will be erased. Individual channels cannot be erased.

The HomeLink® universal transmitter is disabled when the Vehicle Security system is active.

## TROUBLESHOOTING TIPS

If you are having trouble programming HomeLink®, here are some of the most common solutions:

- Replace the battery in the garage door opener hand-held transmitter.
- Push the LEARN button on the garage door opener to complete the training for a rolling code.
- Did you unplug the device for programming and remember to plug it back in?

If you have any problems, or require assistance, please call toll-free 1-800-355-3515 or visit HomeLink.com for information or assistance.

**WARNING!**

- Vehicle exhaust contains carbon monoxide, a dangerous gas. Do not run your vehicle in the garage while programming the transmitter. Exhaust gas can cause serious injury or death.
- Your motorized door or gate will open and close while you are programming the universal transmitter. Do not program the transmitter if people, pets or other objects are in the path of the door or gate. Only use this transmitter with a garage door opener that has a "stop and reverse" feature as required by Federal safety standards. This includes most garage door opener models manufactured after 1982. Do not use a garage door opener without these safety features.

**EXTERIOR LIGHTS****MULTIFUNCTION LEVER**

The multifunction lever is located on the left side of the steering column. The multifunction lever controls the turn signals, headlight high/low beams, and flash-to-pass functions.



A0216000092US

**Multifunction Lever****HEADLIGHT SWITCH**

The headlight switch is located on the left side of the instrument panel. The switch controls the operation of the headlights, parking lights, instrument panel lights, interior lights, and the fog lights.

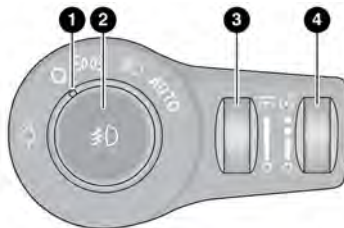

A0216000105US

**Headlight Switch**

- 1 — Rotate Headlight Control
- 2 — Push Fog Light Control
- 3 — Ambient Light Dimmer Control
- 4 — Instrument Panel Dimmer Control

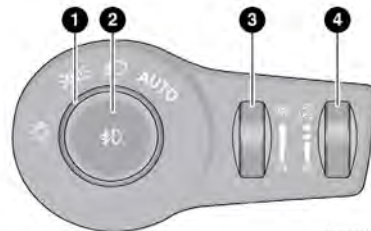

A0216000197US

**Headlight Switch (Vehicles Sold In Canada Only)**

- 1 — Rotate Headlight Control
- 2 — Push Fog Light Control
- 3 — Ambient Light Dimmer Control
- 4 — Instrument Panel Dimmer Control

**NOTE:**

Vehicles sold in Canada are equipped with a headlight switch with an AUTO and ON detent but without an OFF detent. Headlights will be deactivated when the headlight switch is placed in the parking lights position. However, the Daytime Running Lights (DRLs) will be activated along with the front and rear marker lights. The DRLs may be deactivated when the parking brake is engaged.

From the O (off) position, rotate the headlight switch clockwise to the first detent for parking light and instrument panel light operation. Rotate the headlight switch to the second detent for headlight, parking light and instrument panel operation.



**NOTE:**

For vehicles sold in Canada, rotate the headlight switch clockwise from the parking light and instrument panel light position to the first detent to turn on the headlights also. Rotate to the second detent, AUTO position, to turn on automatic headlights, parking lights, and instrument panel lights.

## DAYTIME RUNNING LIGHTS (DRLS) — IF EQUIPPED

The headlights or LED light bars on your vehicle will illuminate when the engine is started. This provides a constant lights on condition until the ignition is placed in the OFF position. If the parking brake is applied, the Daytime Running Lights (DRLs) will turn off.

**NOTE:**

- For vehicles sold in Canada, the Daytime Running Lights will automatically deactivate when the front fog lights are turned on.
- If allowed by law in the country in which the vehicle was purchased, the Daytime Running Lights can be turned on or off using the Uconnect system  page 169.
- On some vehicles, the Daytime Running Lights may deactivate, or reduce intensity, on one side of the vehicle (when a turn signal is activated on that side), or on both sides of the vehicle (when the hazard warning lights are activated).

## HIGH/LOW BEAM SWITCH

Push the multifunction lever toward the instrument panel to switch the headlights to high beams. Pulling the multifunction lever back will turn the low beams on.

## AUTOMATIC HIGH BEAM — IF EQUIPPED

The Automatic High Beam system provides increased forward lighting at night by automatically controlling the high beams through the use of a camera mounted on the windshield. This camera detects vehicle specific light and automatically switches from high beams to low beams until the approaching vehicle is out of view.

**NOTE:**

Broken, muddy, or obstructed headlights and taillights of vehicles in the field of view will cause headlights to remain on longer (closer to the vehicle). Also, dirt, film and other obstructions on the windshield or camera lens will cause the system to function improperly.

### To Activate

1. Select “Auto Dim High Beams” through the Uconnect system to enable the feature  page 169.
2. Rotate the headlight switch clockwise to the AUTO position.
3. Push the multifunction lever away from you to switch the headlights to the high beam position. Refer to “Multifunction Lever” in this section for further information.

**NOTE:**

This system will not activate until the vehicle is at, or above 16 mph (25 km/h).

### To Deactivate

Perform either of the following steps to deactivate the Automatic High Beam system.

1. Deselect “Auto Dim High Beams” through the Uconnect system  page 169.
2. Pull the multifunction lever toward you to switch the headlights from the high beam to the low beam position.
3. Rotate the headlight switch counterclockwise from the AUTO to the on position.

**NOTE:**

Once active, the Automatic High Beam system will stop functioning below 12 mph (20 km/h).

## FLASH-TO-PASS

You can signal another vehicle with your headlights by lightly pulling the multifunction lever toward you. This will cause the high beam headlights to turn on, and remain on, until the lever is released.

## AUTOMATIC HEADLIGHTS — IF EQUIPPED

This system automatically turns your headlights on or off based on ambient light levels. To turn the system on, turn the headlight switch to the extreme clockwise position aligning the indicator with the AUTO on the headlight switch. When the system is on, the Headlight Time Delay feature is also on. This means your headlights will stay on for up to 90 seconds after the ignition is placed in the OFF position. To turn the automatic system off, move the headlight switch out of the AUTO position.

### NOTE:

The engine must be running before the headlights will come on in the Automatic mode.

## HEADLIGHTS ON WITH WIPERS — IF EQUIPPED

When your headlights are in the AUTO mode and the engine is running, the headlights will automatically turn on when the wiper system is also turned on. Headlights on when windshield wipers are on may be found on vehicles equipped with an automatic headlight system.

### NOTE:

The Headlights with Wipers feature can be turned on or off through the Uconnect system ↪ page 169.

## HEADLIGHT TIME DELAY — IF EQUIPPED

This feature provides the safety of headlight illumination for up to 90 seconds after exiting your vehicle.

To activate the delay feature, place the ignition in the OFF position while the headlights are still on. The 90 second delay interval begins when headlight switch is turned off. If the headlights or parking lights are turned back on or the ignition is placed in the ON position, the delay will be cancelled.

When exiting the vehicle the driver can choose to have the headlights remain on for 30, 60, or 90 seconds or not remain on. You can change the timer setting through the Uconnect system ↪ page 169.

If the headlights are turned off before the ignition, they will turn off in the normal manner.

### NOTE:

The headlights must be turned off within 45 seconds of placing the ignition in the OFF position to activate this feature.

## LIGHTS-ON REMINDER

If the headlights or the parking lights are left on after the ignition is placed in the OFF position, the vehicle will chime when the driver's door is opened.

## FRONT FOG LIGHTS — IF EQUIPPED

To activate the front fog lights, turn on the parking lights or the low beam headlights and push the headlight switch control knob. Pushing the headlight switch control knob a second time will turn the front fog lights off.



A0216000198US

Fog Light Switch

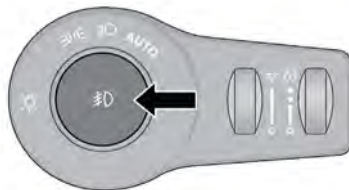

A0216000198US

Fog Light Switch (Vehicles Sold In Canada Only)

## TURN SIGNALS

Move the multifunction lever up or down to activate the turn signals. The arrows on each side of the instrument cluster flash to show proper operation.

### NOTE:

If either light remains on and does not flash, or there is a very fast flash rate, check for a defective outside light bulb.

## Turn Signal Warning

If the vehicle electronics sense that the vehicle has traveled for about 1 mile (1.6 km) with the turn signals on, a chime will sound and a message will display in the cluster to alert the driver.

## LANE CHANGE ASSIST — IF EQUIPPED

Tap the multifunction lever up or down once, without moving beyond the detent, and the turn signal (right or left) will flash three times then automatically turn off.

## BATTERY SAVER

Timers are set to both the interior and exterior lights to protect the life of your vehicle's battery.

After 10 minutes, if the ignition is in the OFF position, and any door is left open or the dimmer control is rotated all the way up to the dome light on position, the interior lights will automatically turn off.

### NOTE:

Battery saver mode is canceled if the ignition is placed in the ON position.

If the headlights remain on while the ignition is placed in the OFF position, the exterior lights will automatically turn off after eight minutes. If the headlights are turned on and left on for eight minutes while the ignition is OFF, the exterior lights will automatically turn off.

## INTERIOR LIGHTS

### INTERIOR COURTESY LIGHTS

The courtesy light switches are used to turn the courtesy lights on/off.



Courtesy Light Switches

To operate the courtesy lights, push either the driver or passenger light switch.

### NOTE:

- Before exiting the vehicle, make sure that the interior lights are turned off. This will prevent the battery from discharging once the doors are closed.
- If a light is left on, it will automatically be turned off approximately 10 minutes after the ignition is placed in the OFF position.

## Rear Courtesy/Reading Lights — If Equipped

Located above the rear passengers are courtesy/reading lights. The lights turn on when a front door, a sliding door or the liftgate is opened. If your vehicle is equipped with Remote Keyless Entry (RKE) the lights will also turn on when the unlock button on the key fob is pushed.

The courtesy lights also function as reading lights. Push the lens to turn these lights on while inside the vehicle. Push the lens a second time to turn each light off.

## Dimmer Controls

The dimmer controls are part of the headlight switch, and are located on the driver's side of the instrument panel.

With the parking lights or headlights on, rotating the right dimmer control upward will increase the brightness of the instrument cluster lights. Rotating the left dimmer control will adjust the interior light levels of the ambient lighting on the instrument panel and doors.

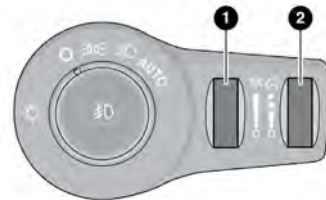

Dimmer Controls

- 1 — Ambient Light Dimmer Control  
2 — Instrument Panel Dimmer Control

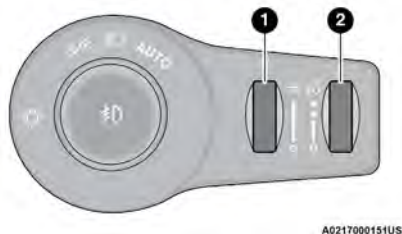

**Dimmer Controls (Vehicles Sold In Canada Only)**

- 1 – Ambient Light Dimmer Control
- 2 – Instrument Panel Dimmer Control

At the top detent of the instrument panel dimmer, all the interior lights will illuminate. At the bottom most setting (extreme bottom) interior lights are turned off (dome off), and the cluster, radio and instrument lighting go to their lowest dimmable setting.

## WINDSHIELD WIPER AND WASHERS

The windshield wiper/washer controls are located on the right side of the steering column. The front wipers are operated by rotating a switch, located on the end of the lever.

### WINDSHIELD WIPER OPERATION

The wipers and washers are operated by a switch within the wiper lever. Rotate the switch at the end of the lever upward, to the first detent past the intermittent settings for low-speed wiper operation. Rotate the switch at the end of the lever upward to the second detent past the

intermittent settings for high-speed wiper operation. To turn the windshield wipers off, rotate the switch within the lever all the way down to OFF.

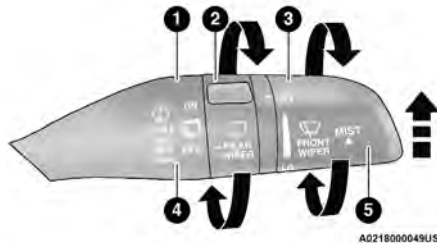

**Windshield Wiper Operation**

- 1 – Pull For Front Washer
- 2 – Rotate For Rear Wiper Operation
- 3 – Rotate For Front Wiper Operation
- 4 – Push Forward For Rear Washer
- 5 – Push Up For Mist

#### CAUTION!

Always remove any buildup of snow that prevents the windshield wiper blades from returning to the parked position. If the windshield wiper switch is turned off, and the blades cannot return to the parked position, damage to the wiper motor may occur.

#### Intermittent Wipers

Use the intermittent wiper when weather conditions make a single wiping cycle with a variable pause between cycles desirable. Rotate the switch at the end of the wiper lever to the first detent position, and then

turn the switch at the end of the lever to select the desired delay interval. There are four delay settings, which allow you to regulate the wipe interval from a minimum of one cycle every second to a maximum of approximately 36 seconds between cycles. The delay intervals will double in duration when the vehicle speed is 10 mph (16 km/h) or less.

#### Windshield Washers

To use the washer, pull the lever rearward toward you and hold. If the lever is pulled while on the intermittent setting, the wipers will turn on and operate for several wipe cycles after the lever is released, and then resume the intermittent interval previously selected. If the lever is pulled while the wipers are in the off position, the wipers will operate several cycles, then turn off.

#### WARNING!

Sudden loss of visibility through the windshield could lead to a collision. You might not see other vehicles or other obstacles. To avoid sudden icing of the windshield during freezing weather, warm the windshield with the defroster before and during windshield washer use.

#### Mist

Push the lever upward to the MIST position and release for a single wiping cycle.

#### NOTE:

The Mist feature does not activate the washer pump; therefore, no washer fluid will be sprayed on the windshield. The washer function must be used in order to spray the windshield with washer fluid.

For information on wiper care and replacement, see page 273.

## RAIN SENSING WIPERS — IF EQUIPPED

This feature senses rain or snowfall on the windshield and automatically activates the wipers. Rotate the end of the windshield wiper lever to one of the four detent positions to activate this feature.

The sensitivity of the system is adjustable from the windshield wiper lever. Wiper sensitivity position 1 is the least sensitive, and wiper sensitivity position 4 is the most sensitive.

### NOTE:

- The Rain Sensing feature will not operate when the wiper switch is in the low or high position.
- The Rain Sensing feature may not function properly when ice or dried saltwater is present on the windshield.
- Use of products containing wax or silicone may reduce rain sensor performance.
- The Rain Sensing feature can be turned on or off through the Uconnect system → page 169.

The Rain Sensing system has protective features for the wiper blades and arms. It will not operate under the following conditions:

- **Low Temperature Wipe Inhibit** — The Rain Sensing feature will not operate when the ignition is first placed in the ON position, when the vehicle is stationary and the outside temperature is below 32° F (0° C), unless the wiper control on the windshield wiper lever is moved, the vehicle speed becomes greater than 3 mph (5 km/h) or the outside temperature rises above freezing.

- **Neutral Wipe Inhibit** — The Rain Sensing feature will not operate when the ignition is ON, when the transmission gear selector is in the NEUTRAL position and the vehicle speed is less than 3 mph (5 km/h), unless the wiper control on the windshield wiper lever is moved, the vehicle speed is greater than 3 mph (5 km/h) or the gear selector is moved out of the NEUTRAL position.
- **Remote Start Mode Inhibit** — On vehicles equipped with the Remote Start system, Rain Sensing wipers are not operational when the vehicle is in the Remote Start mode. Once the operator is in the vehicle and has placed the ignition switch in the ON/RUN position, rain sensing wiper operation can resume, if it has been selected, and no other inhibit conditions (mentioned previously) exist.

## REAR WIPER AND WASHER

The rear wiper/washer is operated by rotating a switch, located at the middle of the lever.



Rotate the center portion of the lever upward to the first detent for intermittent operation and to the second detent for continuous rear wiper operation.

### Rear Window Washer Operation



Pushing the windshield wiper lever forward activates the rear window washer. If the lever is pushed while on the intermittent setting, the wiper will turn on and operate for several wipe cycles after the lever is released, and then resume the intermittent interval previously selected. If the lever is pushed while the wiper is in the off position, the wiper will operate several wipe cycles, then turn off.

## CLIMATE CONTROLS

The Climate Control system allows you to regulate the temperature, air flow, and direction of air circulating throughout the vehicle. The controls are located on the touchscreen and on the instrument panel below the radio.

2

## AUTOMATIC CLIMATE CONTROL DESCRIPTIONS AND FUNCTIONS



Uconnect 5 With 7-inch Display Automatic Temperature Controls



**Uconnect 5/5 NAV With 10.1-inch Display Automatic Temperature Controls**

## Max A/C Button



Press and release the MAX A/C button on the touchscreen to change the current setting to the coldest output of air. The MAX A/C indicator illuminates when MAX A/C is on.

Pressing the button again will cause the MAX A/C operation to exit.

### NOTE:

The MAX A/C setting is only available on the touchscreen.

## A/C Button



Press and release the button on the touchscreen, or push the button on the faceplate to change the current setting. The indicator illuminates when A/C is on.

### NOTE:

- If the system is in Mix or Defrost Mode, the A/C can be turned off, but the A/C system shall remain active to prevent fogging of the windows.
- If not operating in AUTO mode, the system will not automatically sense the presence of fog, mist or ice on the windshield. Defrost Mode must be manually selected to clear the windshield and side glass.
- If fog or mist appears on the windshield or side glass, select Defrost Mode and adjust blower speed if needed.

## Recirculation Button



Press and release the Recirculation button on the touchscreen, or press the button on the faceplate, to change the system between recirculation mode and outside air. The

Recirculation indicator and the A/C indicator illuminate when the Recirculation button is pressed. Recirculation can be used when outside conditions such as smoke, odors, dust, or high humidity are present. Recirculation can be used in all modes. Recirculation may be unavailable (button on the touchscreen grayed out) if conditions exist that could create fogging on the inside of the windshield. The A/C can be deselected manually without disturbing the mode control selection. Continuous use of Recirculation mode may make the inside air stuffy and window fogging may occur. Extended use of this mode is not recommended. Recirculation mode may automatically adjust to optimize customer experience for warming, cooling, dehumidification, etc.

## AUTO Button



Set your desired temperature and press the AUTO button on the touchscreen, or push the button on the faceplate. AUTO will achieve and maintain your desired temperature by automatically adjusting the blower speed and air distribution. Air Conditioning (A/C) may be active during AUTO operation to improve performance. AUTO mode is highly recommended for efficiency. You can turn AUTO on in one of two ways:

- Press and release this button on the touchscreen
- Push the button on the faceplate

Toggle this function will cause the system to switch between manual mode and automatic mode

↩ page 76.

## Front Defrost Button



Press and release the Front Defrost button on the touchscreen, or push the button on the faceplate to change the current airflow setting to Defrost mode. The indicator illuminates when this feature is on. Air comes from the windshield and side window demist outlets. When the defrost button is selected, the blower level may increase. Use Defrost mode with maximum temperature settings for best windshield and side window defrosting and defogging. Performing this function will cause the Automatic Temperature Control (ATC) to switch into manual mode. If the Front Defrost mode is turned off the climate system will return to the previous setting.

## Rear Defrost Button



Press and release the Rear Defrost Control button on the touchscreen or push and release the button on the faceplate to turn on the rear window defroster and the heated outside mirrors (if equipped). An indicator will illuminate when the rear window defroster is on. The rear window defroster automatically turns off after 15 minutes.

### CAUTION!

Failure to follow these cautions can cause damage to the heating elements:

- Use care when washing the inside of the rear window. Do not use abrasive window cleaners on the interior surface of the window. Use a soft cloth and a mild washing solution, wiping parallel to the heating elements. Labels can be peeled off after soaking with warm water.
- Do not use scrapers, sharp instruments, or abrasive window cleaners on the interior surface of the window.
- Keep all objects a safe distance from the window.

## Front Temperature Control

These buttons provide the driver and passenger with independent temperature control.



Push the red button on the faceplate or touchscreen or press and slide the temperature bar towards the red arrow button on the touchscreen for warmer temperature settings.



Push the blue button on the faceplate or touchscreen or press and slide the temperature bar towards the blue arrow button on the touchscreen for cooler temperature settings.

### NOTE:

The temperature can also be adjusted by pressing the Temperature readout on the top left and right corners of the status bar.

## SYNC Button



Press the SYNC button on the touchscreen to toggle the SYNC feature on/off. The SYNC indicator is illuminated when this feature is enabled. SYNC is used to synchronize the front and rear passenger temperature settings with the driver temperature setting. Changing the front or rear passenger temperature setting while in SYNC will automatically exit this feature.

### NOTE:

The SYNC setting is only available on the touchscreen.

## Blower Control



Blower Control regulates the amount of air forced through the climate control system. There are seven blower speeds available. Adjusting the blower will cause automatic mode to switch to manual operation. The speeds can be selected using either the blower control knob on the faceplate or the buttons on the touchscreen.

- **Faceplate:** The blower speed increases as you turn the blower control knob clockwise from the lowest blower setting. The blower speed decreases as you turn the blower control knob counterclockwise.

- **Touchscreen:** Blower speed can be selected by pressing the blower bar area between the icons. Press the desired blower speed from 1-7.

## Mode Control



The airflow distribution mode can be adjusted so air comes from the instrument panel outlets, floor outlets, defrost outlets and demist outlets.

**Faceplate:** Push the button in the center of the knob to change the airflow distribution mode.

**Touchscreen:** Select Mode by pressing one of the Mode Buttons on the touchscreen.

## Panel Mode



Air comes from the outlets in the instrument panel. Each of these outlets can be individually adjusted to direct the flow of air. The air vanes of the center outlets and outboard outlets can be moved up and down or side to side to regulate airflow direction. There is a shut-off wheel located below the air vanes to shut off or adjust the amount of airflow from these outlets.

## Bi-Level Mode



Air comes from the instrument panel outlets and floor outlets. A slight amount of air is directed through the defrost and side window demister outlets.

### NOTE:

Bi-Level mode is designed under comfort conditions to provide cooler air out of the panel outlets and warmer air from the floor outlets.

## Floor Mode



Air comes from the floor outlets. A slight amount of air is directed through the defrost and side window demister outlets.

## Mix Mode



Air is directed through the floor, defrost, and side window demister outlets. This setting works best in cold or snowy conditions that require extra heat to the windshield. This setting is good for maintaining comfort while reducing moisture on the windshield.

## Climate Control OFF Button



Press and release this button on the touchscreen or push and release the button on the faceplate to turn the Climate Control ON/OFF.

## Controlling The Rear Climate Controls From The Front ATC Panel—If Equipped

The Three-Zone Automatic Temperature Control (ATC) system allows for adjustment of the rear climate controls from the front ATC panel.

### To change the rear system settings:

- Press the Rear Climate button on the touchscreen to display the rear climate controls. Control functions now operate the rear system.
- To return to the Front screen on the Uconnect system, press the Front Climate or Done button on the touchscreen.

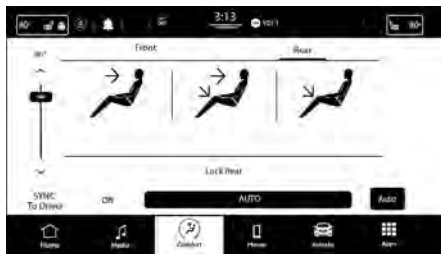

Uconnect 5 With 10.1-in Display Rear Control Screen

## REAR CLIMATE CONTROL BUTTON



Press and release the Rear button to access the rear climate controls. The indicator will illuminate when the rear climate controls are on.

## REAR AUTO BUTTON



Press and release the AUTO button on the touchscreen, within the Rear screen, to change the current setting. The REAR AUTO indicator will illuminate when REAR AUTO is on. This feature automatically controls the rear interior cabin temperature by adjusting airflow distribution and amount. Toggling this function will cause the rear system to switch between manual mode and automatic modes ↔ page 76.

## REAR LOCK BUTTON



Press and release this button to lock out the rear manual temperature controls from adjusting the rear temperature and blower settings.

## FRONT CLIMATE BUTTON



Press and release the Front button to change the display on the Uconnect system back to the Front Climate Controls.

## REAR TEMPERATURE CONTROL

These buttons provide the front occupants with the ability to control the rear temperature.



Push the up arrow button on the touchscreen to increase the temperature.



Push the down arrow button on the touchscreen to decrease the temperature.

### NOTE:

When the SYNC feature is active, the passenger's temperature will move up and down with the driver's temperature.

## SYNC BUTTON



Press the SYNC To Driver button on the touchscreen to toggle the SYNC feature on/off. The SYNC indicator is illuminated when this feature is enabled. SYNC is used to synchronize the front and rear passenger temperature settings with the driver temperature setting. Changing the front or rear passenger temperature/mode/blower settings while in SYNC will automatically exit this feature.

### NOTE:

The SYNC setting is only available on the touchscreen.



## BLOWER CONTROL



Blower Control is used to regulate the amount of air forced through the Climate Control system. There are seven blower speeds available. Adjusting the blower causes automatic mode to switch to manual operation. The speeds can be selected using the buttons on the touchscreen.

## PANEL MODE



Press this button on the touchscreen to change the air distribution mode to Panel Mode. In Panel Mode, air comes from the outlets in the headliner. Each of these outlets can be individually adjusted to direct the flow of air. Moving the air vanes of the outlets to one side will shut off the airflow.

## BI-LEVEL MODE



Press this button on the touchscreen to change the air distribution mode to Bi-Level Mode. In Bi-Level Mode, air comes from both the headliner outlets and the floor outlets.

### NOTE:

Bi-Level mode is designed under comfort conditions to provide cooler air out of the panel outlets and warmer air from the floor outlets.

## FLOOR MODE



Press this button on the touchscreen to change the air distribution mode to Floor Mode. In Floor Mode, air comes from the floor outlets.

## REAR PASSENGER CLIMATE CONTROL OFF BUTTON



Press and release the OFF button to turn the Rear Climate Controls off.

## Rear Automatic Temperature Control (ATC) — If Equipped

The rear Automatic Temperature Control (ATC) system has floor air outlets underneath the passengers' seats, and overhead outlets at each outboard rear seating position. The system provides heated air through the floor outlets or cool, dehumidified air through the headliner outlets.

Rear second row occupants can only adjust the rear ATC control when the Rear Temperature Lock button is turned off.

The rear ATC system is located in the headliner, on the passenger side of the vehicle.

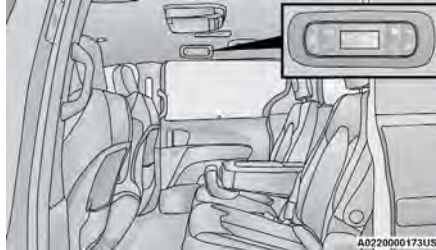

Rear Automatic Climate Controls

1. Adjust the rear blower, rear temperature and the rear modes to suit your comfort needs.
2. ATC is selected by pushing the AUTO button.

Once the desired temperature is displayed, the ATC System will automatically achieve and maintain that comfort level. When the system is set up for your comfort level, it is not necessary to change the settings. You will experience the greatest efficiency by simply allowing the system to function automatically.

### NOTE:

It is not necessary to move the temperature settings. The system automatically adjusts the temperature, mode and fan speed to provide comfort as quickly as possible.

## AUTO BUTTON



The AUTO button automatically controls the interior cabin temperature by adjusting distribution and amount of airflow. Performing this function will cause the system to switch between manual mode and automatic modes



page 76.

## REAR TEMPERATURE CONTROL



To change the temperature in the rear of the vehicle, push temperature control up button to raise the temperature. The rear temperature settings are displayed in control head.



To change the temperature in the rear of the vehicle, push temperature control down button to lower the temperature. The rear temperature settings are displayed in control

head.

## REAR BLOWER CONTROL



The rear blower control can be manually set to off, or any fixed blower speed by pushing the blower control buttons. This allows the rear seat occupants to control the volume of air circulated in the rear of the vehicle. The larger of the two icons increases blower speed, whereas the smaller of the two icons decreases the blower speed.

## REAR MODE CONTROL



Push this button on the Rear Climate Controls to change the air distribution mode for the rear passengers.

## PANEL MODE



Air comes from the outlets in the headliner. Each of these outlets can be individually adjusted to direct the flow of air. Moving the air vanes of the outlets to one side will shut off the airflow.

## BI-LEVEL MODE



Air comes from both the headliner outlets and the floor outlets.

### NOTE:

In many temperature positions, the Bi-Level mode is designed to provide cooler air out of the headliner outlets and warmer air from the floor outlets.

## FLOOR MODE



Air comes from the floor outlets.

## REAR CLIMATE CONTROL/BLOWER OFF



To manually set the rear blower controls to off, press the Rear Climate Control/Blower Off button.

## MANUAL CLIMATE CONTROL DESCRIPTIONS AND FUNCTIONS



Uconnect 5 With 7-inch Display Manual Temperature Controls

## MAX A/C Button



Press and release the MAX A/C button to change the current setting. The indicator illuminates when MAX A/C is on. Performing this function again will cause the MAX A/C operation to switch into manual mode and the MAX A/C indicator will turn off.

### NOTE:

The MAX A/C setting is only available on the touchscreen.

## A/C Button



Press and release the A/C button to change the current setting. The indicator illuminates when A/C is on.

### NOTE:

- For Manual Climate Controls, if the system is in Mix, Floor or Defrost Mode, the A/C can be turned off, but the A/C system shall remain active to prevent fogging of the windows.
- If fog or mist appears on the windshield or side glass, select Defrost mode, and increase blower speed if needed.
- If your air conditioning performance seems lower than expected, check the front of the A/C condenser (located in front of the radiator), for an accumulation of dirt or insects. Clean with a gentle water spray from the front of the radiator and through the condenser.

## Recirculation Button



Press and release this button to change the system between recirculation mode and outside air mode. The Recirculation indicator and the A/C indicator illuminate when the Recirculation button is pressed. Recirculation can be used when outside conditions such as smoke, odors, dust, or high humidity are present. Recirculation can be used in all modes except for Defrost. Recirculation may be unavailable (button on the touchscreen grayed out) if conditions exist that could create fogging on the inside of the windshield. The A/C (Air Conditioning) can be deselected manually without disturbing the mode control selection.

Continuous use of the Recirculation mode may make the inside air stuffy and window fogging may occur. Extended use of this mode is not recommended. On systems with Manual Climate Controls, the Recirculation mode (if equipped) is not allowed in Defrost mode to improve window clearing operation. Recirculation is disabled automatically if this mode is selected. Attempting to use Recirculation while in this mode causes the LED on the control button to blink and then turn off.

### Front Defrost Button



Press and release the Front Defrost button to change the current airflow setting to Defrost mode. The indicator illuminates when this feature is on. Air comes from the windshield and side window demist outlets. When the defrost button is selected, the blower level may increase. Use Defrost mode with maximum temperature settings for best windshield and side window defrosting and defogging. Performing this function will cause the Automatic Temperature Control (ATC) to switch into manual mode. If the Front Defrost mode is turned off the climate system will return the previous setting.

### Rear Defrost Button



Push and release the Rear Defrost Control button to turn on the rear window defroster and the heated outside mirrors (if equipped). An indicator will illuminate when the rear window defroster is on. The rear window defroster automatically turns off after 15 minutes.

### CAUTION!

Failure to follow these cautions can cause damage to the heating elements:

- Use care when washing the inside of the rear window. Do not use abrasive window cleaners on the interior surface of the window. Use a soft cloth and a mild washing solution, wiping parallel to the heating elements. Labels can be peeled off after soaking with warm water.
- Do not use scrapers, sharp instruments, or abrasive window cleaners on the interior surface of the window.
- Keep all objects a safe distance from the window.

### Front Temperature Control

These buttons provide the driver and passenger with independent temperature control.



Push the red button on the faceplate or touchscreen or press and slide the temperature bar towards the red arrow button on the touchscreen for warmer temperature settings.



Push the blue button on the faceplate or touchscreen or press and slide the temperature bar towards the blue arrow button on the touchscreen for cooler temperature settings.

### SYNC Button



Press the SYNC button on the touchscreen to toggle the Sync feature on/off. The SYNC indicator is illuminated when this feature is enabled. SYNC is used to synchronize the front and rear passenger temperature settings with the driver temperature setting. Changing the front or rear passenger temperature setting while in SYNC will auto-

matically exit this feature. Pressing SYNC on the touchscreen while in the Front Climate screen synchronizes the driver and passenger temperatures only. In order to SYNC rear temperature to driver temperature, the touchscreen must be on the Rear Climate screen.

### NOTE:

The SYNC setting is only available on the touchscreen.

### Blower Control



Blower Control is used to regulate the amount of air forced through the Climate Control system. There are seven blower speeds available. The speeds can be selected using either the blower control knob on the faceplate or the buttons on the touchscreen.

- **Faceplate:** The blower speed increases as you turn the blower control knob clockwise from the lowest blower setting. The blower speed decreases as you turn the blower control knob counterclockwise.
- **Touchscreen:** Use the small blower icon to reduce the blower setting and the large blower icon to increase the blower setting. Blower speed can also be selected by pressing the blower bar area between the icons.

### Mode Control



The airflow distribution mode can be adjusted so air comes from the instrument panel outlets, floor outlets, defrost outlets and demist outlets.

**Faceplate:** Push the button in the center of the knob to change the airflow distribution mode.

**Touchscreen:** Select Mode by pressing one of the Mode Buttons on the touchscreen.

## Panel Mode



Air comes from the outlets in the instrument panel. Each of these outlets can be individually adjusted to direct the flow of air. The air vanes of the center outlets and outboard outlets can be moved up and down or side to side to regulate airflow direction. There is a shut-off wheel located below the air vanes to shut off or adjust the amount of airflow from these outlets.

## Bi-Level Mode



Air comes from the instrument panel outlets and floor outlets. A slight amount of air is directed through the defrost and side window demister outlets.

### NOTE:

Bi-Level mode is designed under comfort conditions to provide cooler air out of the panel outlets and warmer air from the floor outlets.

## Floor Mode



Air comes from the floor outlets. A slight amount of air is directed through the defrost and side window demister outlets.

## Mix Mode



Air is directed through the floor, defrost, and side window demister outlets. This setting works best in cold or snowy conditions that require extra heat to the windshield. This setting is good for maintaining comfort while reducing moisture on the windshield.

## Climate Control OFF Button



Press and release this button to turn the Climate Control ON/OFF.

## Controlling The Rear Climate Controls From The Front MTC Display/ Touchscreen

The Three-Zone Manual Temperature Control (MTC) system allows for adjustment of the rear climate controls from the front MTC display/touchscreen.

### To change the rear system settings:

- Press the Rear Climate button on the touchscreen to display the rear climate controls. The control functions now operate the rear system.
- Press the Front Climate button on the touchscreen to return to the front climate controls.

## REAR CLIMATE CONTROL BUTTON



Press and release this button to access the rear climate controls. The indicator will illuminate when the rear climate controls are on.

## REAR LOCK BUTTON



Press and release this button to lock out the rear manual temperature controls from adjusting the rear temperature and blower settings.

## FRONT CLIMATE BUTTON



Press and release this button to change the display on the Uconnect system back to the Front Climate Controls.

## REAR TEMPERATURE CONTROL

These buttons provide the rear passengers with independent temperature control.



Push the up arrow button on the touchscreen to increase the temperature.



Push the down arrow button on the touchscreen to decrease the temperature.

### NOTE:

When the SYNC feature is active, the passenger's temperature moves up and down with the driver's temperature.

## SYNC BUTTON



Press the SYNC To Driver button on the touchscreen to toggle the SYNC feature on/off. The SYNC indicator is illuminated when this feature is enabled. SYNC is used to synchronize the front and rear passenger temperature settings with the driver temperature setting. Changing the front or rear passenger temperature setting while in SYNC exits this feature.

### NOTE:

The SYNC setting is only available on the touchscreen.

## BLOWER CONTROL



Blower Control is used to regulate the amount of air forced through the Climate Control system. There are seven blower speeds available. Adjusting the blower causes automatic mode to switch to manual operation. The speeds can be selected using the buttons on the touchscreen.

## PANEL MODE



Press this button on the touchscreen to change the air distribution mode to Panel Mode. In Panel Mode, air comes from the outlets in the headliner. Each of these outlets can be individually adjusted to direct the flow of air. Moving the air vanes of the outlets to one side will shut off the airflow.

## BI-LEVEL MODE



Press this button on the touchscreen to change the air distribution mode to Bi-Level Mode. In Bi-Level Mode, air comes from the headliner and floor outlets.

### NOTE:

Bi-Level Mode is designed under comfort conditions to provide cooler air out of the panel outlets and warmer air from the floor outlets.

## FLOOR MODE



Press this button on the touchscreen to change the air distribution mode to Floor Mode. In Floor Mode, air comes from the floor outlets.

## REAR PASSENGER CLIMATE CONTROL OFF BUTTON



Press and release this button to turn the Rear Climate Controls off.

## Rear Manual Temperature Control (MTC)

The rear Manual Temperature Control (MTC) system has floor air outlets at the rear right side of the third row seats and overhead outlets at each outboard rear seating position. The system provides heated air through the floor outlets or cool, dehumidified air through the headliner outlets.

The rear system temperature control buttons are located on the headliner on the passenger side of the vehicle.

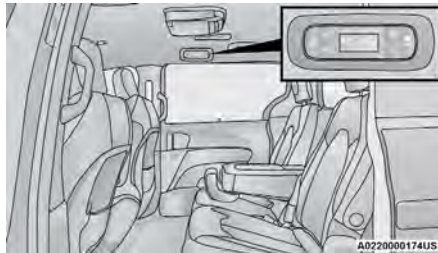

Rear Manual Climate Controls

### CAUTION!

Interior air enters the Rear Automatic Temperature Control system through an intake grille, located in the floor under the passengers' seats. Do not block or place objects directly in front of the inlet grille or heater outlets. The electrical system could overload causing damage to the blower motor.

## REAR TEMPERATURE CONTROL



To change the temperature in the rear of the vehicle, push temperature control up button to raise the temperature. The rear temperature settings are displayed in control head.



To change the temperature in the rear of the vehicle, push temperature control down button to lower the temperature. The rear temperature settings are displayed in control head.

2

## REAR BLOWER CONTROL



The rear blower control can be manually set to off, or any fixed blower speed by pushing the blower control buttons. This allows the rear seat occupants to control the volume of air circulated in the rear of the vehicle. The larger of the two icons increases blower speed, whereas the smaller of the two icons decreases the blower speed.

## REAR MODE CONTROL



Push this button on the Rear Climate Controls to change the air distribution mode for the rear passengers.

## PANEL MODE



Air comes from the outlets in the headliner. Each of these outlets can be individually adjusted to direct the flow of air. Moving the air vanes of the outlets to one side will shut off the airflow.

## BI-LEVEL MODE



Air comes from both the headliner outlets and the floor outlets.

**NOTE:**

In many temperature positions, the Bi-Level mode is designed to provide cooler air out of the headliner outlets and warmer air from the floor outlets.

**FLOOR MODE**

Air comes from the floor outlets.

**REAR CLIMATE CONTROL/BLOWER OFF**

To manually set the rear blower controls to off, press the Rear Climate Control/Blower Off button.

**AUTOMATIC TEMPERATURE CONTROL (ATC) — IF EQUIPPED****Automatic Operation**

1. Push the AUTO button on the faceplate, or the AUTO button on the touchscreen on the Automatic Temperature Control (ATC) Panel.
2. Next, adjust the temperature you would like the system to maintain by adjusting the driver and passenger temperature control buttons. Once the desired temperature is displayed, the system will achieve and automatically maintain that comfort level.
3. When the system is set up for your comfort level, it is not necessary to change the settings. You will experience the greatest efficiency by simply allowing the system to function automatically.

**NOTE:**

- It is not necessary to move the temperature settings for cold or hot vehicles. The system automatically adjusts the temperature, mode, and blower speed to provide comfort as quickly as possible.
- The temperature can be displayed in U.S. or Metric units by selecting the U.S./Metric customer-programmable feature within the Uconnect system [↩](#) page 169.

To provide you with maximum comfort in the Automatic mode during cold start-ups, the blower fan will remain on low until the engine warms up. The blower will increase in speed and transition into Auto mode.

**Manual Operation Override**

This system offers a full complement of manual override features. The AUTO symbol in the front Automatic Temperature Control (ATC) display will be turned off when the system is being used in the manual mode.

**CLIMATE VOICE COMMANDS**

Adjust vehicle temperatures hands-free and keep everyone comfortable while you keep moving ahead (If vehicle is equipped with climate control).

Push the VR button on the steering wheel. After the beep, say one of the following commands:

- “Set driver temperature to 70 degrees”
- “Set passenger temperature to 70 degrees”

**Did you know:** Voice Command for Climate may only be used to adjust the interior temperature of your vehicle. Voice Command will not work to adjust the heated seats or steering wheel if equipped.

**OPERATING TIPS**

Refer to the chart at the end of this section for suggested control settings for various weather conditions.

**Summer Operation**

The engine cooling system must be protected with a high-quality antifreeze coolant to provide proper corrosion protection and to protect against engine overheating.

**Winter Operation**

To ensure the best possible heater and defroster performance, make sure the engine cooling system is functioning properly and the proper amount, type, and concentration of coolant is used. Use of the Air Recirculation mode during Winter months is not recommended, because it may cause window fogging.

**Vacation/Storage**

For information on maintaining the Climate Control system when the vehicle is being stored for an extended period of time, see [↩](#) page 305.

**Window Fogging**

Vehicle windows tend to fog on the inside in mild, rainy, and/or humid weather. To clear the windows, select Defrost or Mix mode and increase the front blower speed. Do not use the Recirculation mode without A/C for long periods, as fogging may occur.

**Outside Air Intake**

Make sure the air intake, located directly in front of the windshield, is free of obstructions, such as leaves. Leaves collected in the air intake may reduce airflow, and if they enter the air distribution box, they could plug the water drains. In Winter months, make sure the air intake is clear of ice, slush, and snow.







## Cabin Air Filter

The Climate Control system filters out dust and pollen from the air. Contact an authorized dealer to service your cabin air filter, and to have it replaced when needed.

## Stop/Start System — If Equipped

While in an Autostop, the Climate Control system may automatically adjust airflow to maintain cabin comfort. Customer settings will be maintained upon return to an engine running condition.

## Operating Tips Chart

WEATHER	CONTROL SETTINGS
Hot Weather And Vehicle Interior Is Very Hot	Set the mode control to  (Panel Mode), <b>A/C</b> (A/C) on, and blower on high. Roll down the windows for a minute to flush out the hot air. Adjust the controls as needed to achieve comfort.
Warm Weather	Turn <b>A/C</b> (A/C) on and set the mode control to  (Panel Mode).
Cool Sunny	Operate in  (Bi-Level Mode).
Cool & Humid Conditions	Set the mode control to  (Floor Mode) and turn <b>A/C</b> (A/C) on to keep windows clear.
Cold Weather	Set the mode control to  (Floor Mode). If windshield fogging starts to occur, move the control to  (Mix Mode).

## INTERIOR STORAGE AND EQUIPMENT

### STORAGE

#### Glove Compartment

The glove compartment is located on the passenger side of the instrument panel.

To open the glove compartment, pull the release handle.



Release Handle

#### Front Door Storage

Both interior front door panels have multiple pockets for storage.

#### WARNING!

If containers of hot liquid are placed in the bottle holder, they can spill when the door is closed, burning the occupants. Be careful when closing the doors to avoid injury.

2

#### Overhead Sunglass Storage

At the front of the overhead console, a compartment is provided for the storage of one pair of sunglasses.

From the closed position, push the indentation to open the compartment.

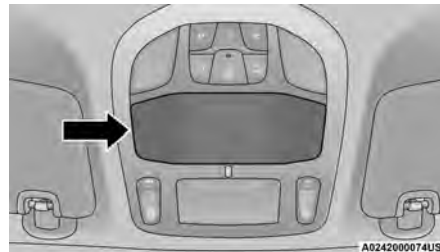

Overhead Sunglass Door Latch

The door will slowly rotate to the full open position.

## Storage Drawers — If Equipped

There may be a storage drawer located in the lower center of the instrument panel, or as part of the center console. It can be released by pushing the access button above the drawer. The drawer is actuator assisted once the access button is pushed. Pull drawer outward to the fully open position.



**Instrument Panel Storage Drawer**

### CAUTION!

The storage drawer must be closed while driving. If left open during a collision, additional damage may occur to property or the drawer mechanism.

## Front Seatback Storage — If Equipped

The front seatbacks have a storage pocket on some models.

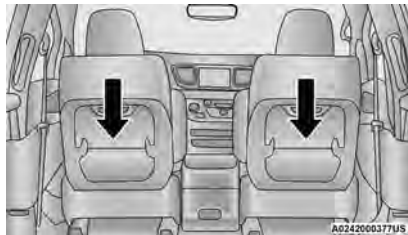

**Front Seatback Storage**

## Second Row Floor Storage Bins

There are removable storage bins (if equipped) located in the areas below the load floor, located in front of the second row seats.

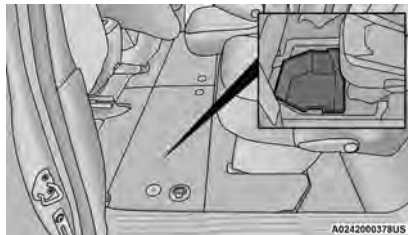

**In Floor Storage Bin**

1. To access the storage bins with front seats in the rearward position, place the lock rod in the unlocked position so the load floor can fold upwards towards the seatback.

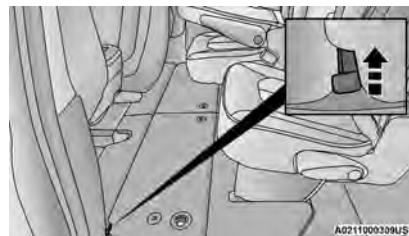

**Lock Rod**

### NOTE:

- Push the lock rod inward for the locked position.
  - Pull outward on the lock rod for the unlocked position.
2. Pull the latch located near the second row seat to open the floor panel.

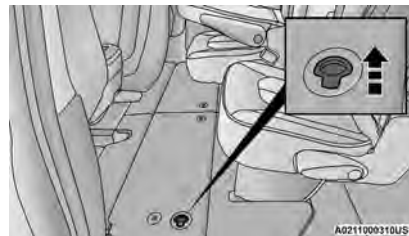

**Floor Latch**



**WARNING!**

In a collision, serious injury could result if the seat storage bin covers are not properly latched.

- Do not drive the vehicle with the storage bin covers open.
- Keep the storage bin covers closed and latched while the vehicle is in motion.
- Do not operate the storage bin covers while the vehicle is in motion.
- Do not use a storage bin latch as a tie down.

**CAUTION!**

The storage bin cover must lie flat and be latched to avoid damage from contact with the front seat tracks, which have minimal clearance to the cover. If the storage bin cover is left in the open position, front seat adjustment may damage the cover.

**STORAGE BIN SAFETY WARNING**

Carefully follow these warnings to help prevent personal injury or damage to your vehicle:

**WARNING!**

- Always close the storage bin covers when your vehicle is unattended.
- Do not allow children to have access to the second row seat storage bins. Once in the storage bin, young children may not be able to escape. If trapped in the storage bin, children can die from suffocation or heat stroke.
- In a collision, serious injury could result if the seat storage bin covers are not properly latched.

(Continued)

**WARNING!**

- Do not drive the vehicle with the storage bin covers open. Keep the storage bin covers closed and latched while the vehicle is in motion.
- Do not operate the storage bin covers while the vehicle is in motion.
- Do not use a storage bin latch as a tie down.

**CAUTION!**

The storage bin cover must lie flat and be latched to avoid damage from contact with the front seat tracks, which have minimal clearance to the cover. If the storage bin cover is left in the open position, front seat adjustment may damage the cover.

**SEAT STORAGE BIN COVER EMERGENCY RELEASE LEVER**

As a security measure, the Seat Storage Bin Cover has an Emergency Release Lever built into the latching mechanism.

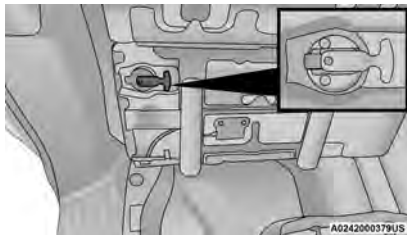

**Storage Bin Cover Emergency Release Lever**

**NOTE:**

In the event of an individual being locked inside the storage bin, the storage bin cover can be opened from inside of the bin by pushing on the glow-in-the-dark lever attached to the storage bin cover latching mechanism.

**LIGHTED CUPHOLDERS — IF EQUIPPED**

On some vehicles, the front cupholders are equipped with a light ring that illuminates the cupholders for the front passengers. The light ring is controlled by the Dimmer Controls ➔ page 65.

**SUN SCREENS — IF EQUIPPED**

Sun screens are available for second and third row seating windows. The screens store in the sill trim panels, and the tops of the windows are equipped with hooks that the sun screens attach to when pulled out.

Gently pull up on the tab to raise the sun screen. Continue pulling the sun screen until the tab is near the top of the window.

Once the screen is completely to the top of the window, extend the top bar of the sun screen over the two hooks attached to the top of the window.

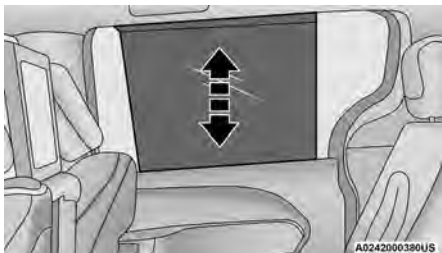
**Sun Screen Extended**

To lower the sun screen, gently lift the tab upward to disengage the hooks, and feed the screen back into the base sill.

## USB/AUX CONTROL

There are numerous USB ports located throughout the vehicle that allow an external USB device to be plugged into the USB port.

### NOTE:

- If a smartphone is plugged into a video USB port, the device will only have charging capability and allow for files/media to be stored, if equipped with Uconnect Theater.
- Once a device is connected to the USB port, it will begin charging and is ready for use with the system. Type C and Type A charge-only USB ports can be used at the same time but cannot be used simultaneously while playing media. When both Type C and Type A charge-only USB ports are in use they will be charged at a reduced rate.

For example, if a device is plugged into the Type A USB port and another device is plugged into the Type C USB port, a message will appear and allow you to select which device to use.

**Front Center Stack AUX Jack And USB Ports**

- 1 – Type C And Type A USB Ports 1
- 2 – Type C And Type A USB Ports 2
- 3 – AUX Port

There are multiple USB “Charge Only” ports in this vehicle.

- In the center console
- On the instrument panel
- On the back of the front row seats in the Uconnect Theater Media Hubs (if equipped)
- On the back of the front row seats
- Above the rear cup holder in the third row of seats

**Charge Only USB In The Center Console**

### NOTE:

The USB outlet in the bottom of the instrument panel can be switched from ignition only to constant battery powered all the time. See an authorized dealer for details.

**Rear Seat USB Charging Port Without Uconnect Theater**

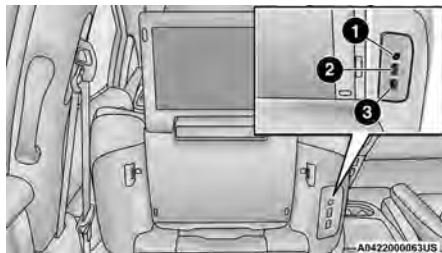

**Rear Seat USB Media Hub With Uconnect Theater**

- 1 – Headphone Jack (Headphone Output Only)  
 2 – HDMI Port  
 3 – USB Port (Charge Only)

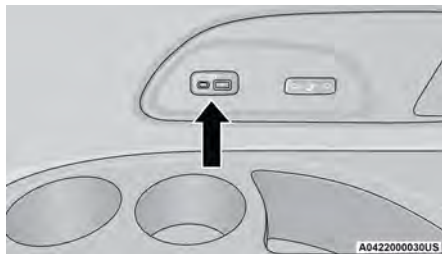

**3rd Row USB Charging Port – If Equipped**

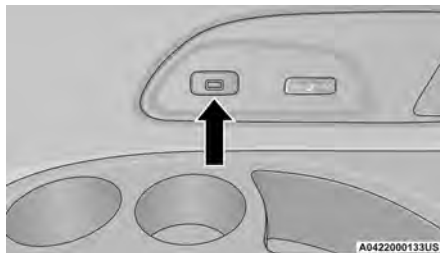

**3rd Row USB Charging Port – If Equipped**

**NOTE:**

The USB “Charge Only” ports will recharge battery operated USB devices when connected.

The following list is of different scenarios when a non-phone device is plugged into the smaller and larger USB ports:

- “A new device is now connected. Previous connection was lost.”
- “(Phone Name) now connected. Previous connection was lost.”
- “Another device is in use through the same USB port. Please disconnect the first device to use the second device.”

Plugging in a phone or another USB device may cause the connection to a previous device to be lost.

**NOTE:**

Charge unsupported devices with the Charge Only USB ports. If an unsupported device is plugged into a Media USB port, a message will display on the touchscreen that the device is not supported by the system.

## POWER OUTLETS

Your vehicle is equipped with 12 Volt (15 Amp) power outlets that can be used to power cellular phones, small electronics and other low powered electrical accessories. The power outlets can be labeled with either a “key” or a “battery” symbol to indicate how the outlet is powered. Power outlets labeled with a key symbol are powered when the ignition is in the ACC or ON/RUN position, while the outlets labeled with a battery symbol are connected directly to the battery and powered at all times.

**NOTE:**

All accessories connected to the battery powered outlets should be removed or turned off when the vehicle is not in use to protect the battery against discharge.

**CAUTION!**

Power outlets are designed for accessory plugs only. Do not insert any other object in the power outlets as this will damage the outlet and blow the fuse. Improper use of the power outlet can cause damage not covered by your New Vehicle Limited Warranty.

Depending on the type of center console your vehicle is equipped with, there is a front power outlet located either on the bottom of the instrument panel or inside the center console.



**12 Volt Front Power Outlet (In Floor Tray) - If Equipped**



**12 Volt Front Power Outlet (In Center Console)**

In addition to the front power outlet, there is also a power outlet located in the rear cargo area.

The rear power outlet is located in the right rear cargo area.

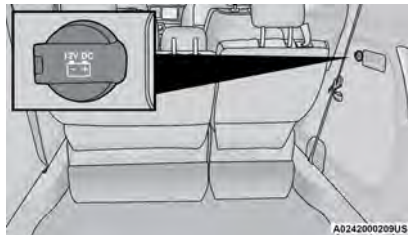

**Rear Power Outlet**

**NOTE:**

The front power outlet can be changed to battery powered at all times by switching the power outlet fuse in the Power Distribution Center panel from fuse location F95A to F95B.

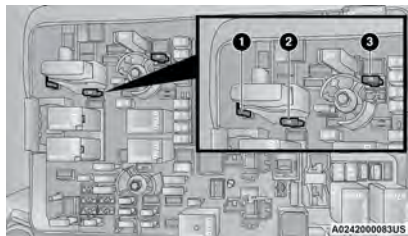

**Power Outlet Fuse Locations**

- 1 – F95A (Ignition)/F95B (Battery) Front Power Outlet 10A
- 2 – F85 Cigar Lighter 20A
- 3 – F60 RR Cargo Power Outlet 20A

**WARNING!**

To avoid serious injury or death:

- Only devices designed for use in this type of outlet should be inserted into any 12 Volt outlet.
- Do not touch with wet hands.
- Close the lid when not in use and while driving the vehicle.
- If this outlet is mishandled, it may cause an electric shock and failure.

**CAUTION!**

- Many accessories that can be plugged in draw power from the vehicle's battery, even when not in use (i.e., cellular phones, etc.). Eventually, if plugged in long enough, the vehicle's battery will discharge sufficiently to degrade battery life and/or prevent the engine from starting.
- Accessories that draw higher power (i.e., coolers, vacuum cleaners, lights, etc.) will degrade the battery even more quickly. Only use these intermittently and with greater caution.
- After the use of high power draw accessories, or long periods of the vehicle not being started (with accessories still plugged in), the vehicle must be driven a sufficient length of time to allow the generator to recharge the vehicle's battery.

## POWER INVERTER — IF EQUIPPED

There is a 115 Volt, 150 W Power Inverter outlet located on the right side of the vehicle, before the third row of seats to convert DC current to AC current. The Power Inverter can power cellular phones, electronics and other low power devices requiring up to 150 W. Certain video game consoles will exceed this power limit, as will most power tools.

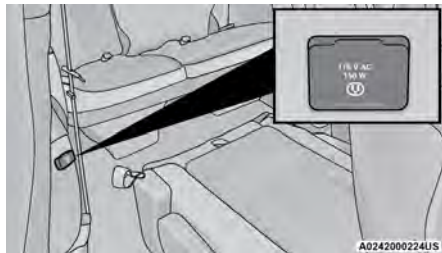

**Power Inverter**

The Power Inverter turns on when the device is plugged in, and the ignition is in ON/RUN position. It turns off when the device is unplugged or the ignition is no longer in ON/RUN position.

The Power Inverter is designed with built-in overload protection. If the power rating of 150 W is exceeded, the Power Inverter shuts down. Once the electrical device has been removed from the Power Inverter, it resets. To avoid overloading the circuit, check the power ratings on electrical devices prior to using the Power Inverter.

### WARNING!

To avoid serious injury or death:

- Do not insert any objects into the receptacles.
- Do not touch with wet hands.
- Close the lid when not in use.
- If this outlet is mishandled, it may cause an electric shock and failure.

## WIRELESS CHARGING PAD — IF EQUIPPED



**Wireless Charging Pad Location**

Your vehicle may be equipped with a 15W 3A Qi® wireless charging pad located below the center stack, within the storage compartment. This charging pad is designed to wirelessly charge your Qi® enabled mobile phone. Qi® is a standard that allows wireless charging of your mobile phone.

Your mobile phone must be designed for Qi® wireless charging. If the phone is not equipped with Qi® wireless charging functionality, an aftermarket sleeve or a specialized back plate can be purchased from your mobile phone provider or a local electronics retailer. Please see your phone's Owner's Manual for further information.

The wireless charging pad is equipped with an anti-slip mat to hold your mobile phone in place, and an LED indicator light.

Place the device inside the prepared area delimited in the mat as shown in the image. Incorrect positioning will prevent the phone from charging.

### LED Indicator Status:

- No Light: Charging pad is idle or searching for a device. Device may not be compatible with the Qi® standard.
- Blue Light: Device is detected and is charging.
- Red Light/Flashing: Internal error, or foreign object is detected.
- Green Light: Device has completed battery charging (if device is equipped to transmit this information).

### Important Notes Regarding This Vehicle's Wireless Charging Pad:

- The presence of the Near-Field Communication (NFC) function active on a smartphone could signal malfunction anomalies.
- The ignition must be in the ON/RUN position in order for the phone to charge.
- To avoid interference with the key fob search, the wireless charging pad will stop charging when any door or liftgate is opened, even if the engine is running.
- Be sure to place the mobile device correctly (display facing upward, and phone not covering the LED) on the wireless charging pad.

- If the phone moves on the pad causing the red light to illuminate, the phone will have to be picked up and placed back on the charging pad to resume charging.
- Wireless charging is not as fast as when the phone is connected to a wired charger.
- The phone's protective case must be removed when placed on the wireless charging pad.
- iPhone® 12 (including iPod®) is equipped with software to protect the device from overheating. When the software is active, the rate of charge is slowed down to protect the device.
- Phones must always be placed on the wireless charging pad within the outline shown on the pad so that its charging parts connect with the charging coils of the system. Movement of the phone during charging may prevent or slow the rate of charge.
- Having multiple applications open on the phone while charging will reduce the charging efficiency, and may even shut down an application that is actively running (i.e. Apple CarPlay®). This may also cause the phone to overheat.
- Wireless chargers may implement certain methods to prevent the phone from overheating during charging such as slowing down the rate of charge. In certain instances, the device may shut down for a brief period of time (when the device reaches a certain temperature). If this happens, it does not mean there is a fault with the wireless charging pad. This may just be a protective measure to prevent damage to the phone.
- The use of multiple wireless functions at the same time (wireless charging, Apple CarPlay®, Android Auto™) could cause the device to overheat, resulting in limitation of the functions or it turning off. In this case, it is recommended to connect the system using the USB port.

- Do not place the key fob or any other type of metal/magnetized object inside the mobile phone housing or near the wireless charging pad.
- With a compatible device placed on the charging pad, and the ignition is cycled to the OFF position, a reminder message may appear on the instrument cluster display to warn the driver.

#### CAUTION!

The key fob should not be placed on the charging pad or within 6 inches (15 cm) of it. Doing so can cause excessive heat buildup and damage to the fob. Placing the fob in close proximity of the charging pad blocks the fob from being detected by the vehicle and prevents the vehicle from starting.

## WINDOWS

### POWER WINDOWS

The window switches on the driver's door trim panel control all of the door windows.

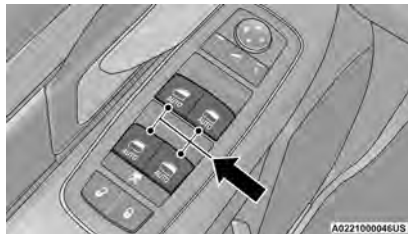

Driver's Power Window Controls

The driver may lock out the rear power windows by pushing the bar control just below the power window controls.

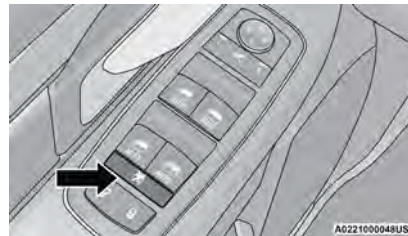

Window Lockout Switch

The window switches will operate only when the ignition is in the ACC or ON/RUN position and during power accessory delay.

#### NOTE:

Power Window controls will also remain active for up to 10 minutes after the ignition has been placed in the OFF position, depending upon the accessory delay setting. Opening a front door will cancel this feature.

There is a single control on the front passenger's door trim panel which operates the passenger door window and a set of controls that lock and unlock all doors. The controls will operate only when the ignition is in the ACC or ON/RUN position and during power accessory delay.

**Sliding Side Door Power Window Control — If Equipped**  
Second row passengers may open and close the sliding door window by a single control on the door handle assembly.

The controls will operate only when the ignition switch is in the ACC or ON/RUN position and during power accessory delay.

**NOTE:**

The controls will not operate if the driver has activated the Power Window Lockout.

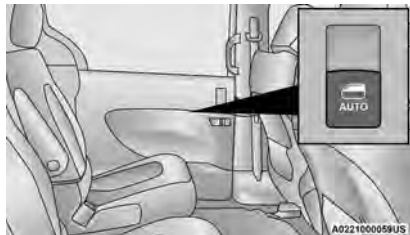

**Sliding Door Power Window Control (Left Side Shown)**

**NOTE:**

The sliding door windows do not fully open, stopping several inches above the window sill.

## AUTOMATIC WINDOW FEATURES

### Auto-Down Feature

The driver and front passenger door power window switches have an Auto-Down feature. Push the window switch down to the second detent, release, and the window will go down automatically.

To stop the window from going all the way down during the Auto-Down operation, pull up or push down on the switch briefly.

### Auto-Up Feature With Anti-Pinch Protection

Lift the window switch up to the second detent, and release; the window will go up automatically.

To stop the window from going all the way up during the Auto-Up operation, push down on the switch briefly.

To close the window part way, lift the window switch briefly and release it when you want the window to stop. If the window runs into any obstacle during auto-closure, it will reverse direction and then go back down. Remove the obstacle and use the window switch again to close the window.

**NOTE:**

Any impact due to rough road conditions may trigger the auto-reverse function unexpectedly during auto-closure. If this happens, pull the switch lightly and hold to close the window manually.

### WARNING!

There is no anti-pinch protection when the window is almost closed. To avoid personal injury be sure to clear your arms, hands, fingers and all objects from the window path before closing.

## RESET AUTO-UP

Should the Auto-Up feature stop working, the window may need to be reset. To reset Auto-Up:

1. Pull the window control up to close the window completely and continue to hold the control up for an additional two seconds after the window is closed.
2. Push the window switch down firmly to open the window completely and continue to hold the switch down for an additional two seconds after the window is fully open.

## WIND BUFFETING

Wind buffeting can be described as the perception of pressure on the ears or a helicopter-type sound in the ears. Your vehicle may exhibit wind buffeting with the windows down, or the sunroof/Power Sliding Top (if equipped) in certain open or partially open positions. This is a normal occurrence and can be minimized. If the buffeting occurs with the rear windows open, open the front and rear windows together to minimize the buffeting. If the buffeting occurs with the sunroof open, adjust the sunroof opening to minimize the buffeting or open any window.

## PANORAMIC SUNROOF — IF EQUIPPED

The Panoramic Sunroof switch is located to the left between the sun visors on the overhead console.

The Power Shade switch is located to the right between the sun visors on the overhead console.

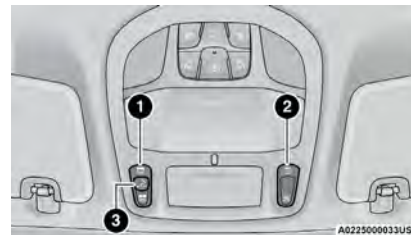

**Panoramic Sunroof And Power Shade Switches**

- 1 — Sunroof Switch
- 2 — Power Shade Switch
- 3 — Vent Button

**WARNING!**

- Never leave children unattended in a vehicle, or with access to an unlocked vehicle. Never leave the key fob in or near the vehicle, or in a location accessible to children. Do not leave the Keyless Enter 'n Go™ Ignition in the ACC or ON/RUN position. Occupants, particularly unattended children, can become entrapped by the power sunroof while operating the power sunroof switch. Such entrapment may result in serious injury or death.
- In a collision, there is a greater risk of being thrown from a vehicle with an open sunroof. You could also be seriously injured or killed. Always fasten your seat belt properly and make sure all passengers are also properly secured.
- Do not allow small children to operate the sunroof. Never allow your fingers, other body parts, or any object, to project through the sunroof opening. Injury may result.

## OPENING AND CLOSING THE SUNROOF

### Express Open/Close

Push the open switch and release it within one second. The sunroof will open automatically from any position and stop at the full open position. This is called Express Open.

Push the close switch and release it within one second and the sunroof will close automatically from any position. The sunroof will close fully and stop automatically. This is called Express Close.

### NOTE:

- During Express Open or Express Close operation, any other actuation of the switch will stop the sunroof.
- If the sunshade is in the closed position when the open switch is pushed, the sunshade will automatically cycle to the halfway open position prior to the sunroof opening.

### Manual Open/Close

Push and hold the open switch and the sunroof will open to the full open position.

To close the sunroof, push and hold the close switch.

Any release of the switch during open or close operation will stop the movement and the sunroof will remain in a partially open condition until the sunroof switch is pushed again.

## OPENING AND CLOSING THE POWER SUNSHADE – IF EQUIPPED

The sunshade has two programmed open positions: half-open and full-open. When opening the sunshade from the closed position, the sunshade will always stop at the half-open position regardless of express or manual open operation. The switch must be actuated again to continue to the full-open position.

### Express Open/Close

Push the sunshade open switch and release it within one second and the sunshade will open to the half-open position and stop automatically. Push and release the sunshade open switch again from the half-open position and the sunshade will open to the full-open position and stop automatically. This is called Express Open.

Push the sunshade close switch and release it within one second and the sunshade will close automatically from any position. If the sunroof is completely closed, the shade will close fully and stop automatically. This is called Express Close.

### NOTE:

- During Express Open or Express Close operation, any movement of the sunshade switch will stop the shade.
- If the sunroof is open, the shade will close to the half-open position. Pushing the shade close button again will automatically close both the sunroof and shade completely.

### Manual Open/Close

Push and hold the sunshade open switch and the shade will open to the half-open position and stop automatically. Push and hold the sunshade open switch again and the shade will open automatically to the full-open position.

To close the shade, push and hold the sunshade close switch.

Any release of the switch will stop the movement and the sunshade will remain in a partially opened condition until the switch is pushed again.

## PINCH PROTECT FEATURE

This feature will detect an obstruction in the closing of the sunroof during the Express Close operation. If an obstruction in the path of the sunroof is detected, the sunroof will automatically retract. Remove the obstruction if this occurs.



**NOTE:**

If three consecutive sunroof close attempts result in Pinch Protect reversals, Pinch Protect will disable and the sunroof must be closed in Manual Mode.

**VENTING SUNROOF**

Push and release the Vent button within one second and the sunroof will open to the vent position. This is called Express Vent, and it will occur regardless of sunroof position.

**NOTE:**

If the sunshade is in the closed position when the vent switch is pushed, the sunshade will automatically cycle to the halfway open position prior to the sunroof opening to the Vent position.

**IGNITION OFF OPERATION**

The power sunroof switch will remain active for up to approximately 10 minutes after the ignition switch is placed in the OFF position. Opening either front door will cancel this feature.

**NOTE:**

Ignition off timing is programmable through the Uconnect system → page 169.

**SUNROOF MAINTENANCE**

Use only a non-abrasive cleaner and a soft cloth to clean the glass panel. Periodically check for and clear out any debris that may have collected in the tracks.

**HOOD****OPENING****WARNING!**

**For Hybrid models:** Always place the ignition in the OFF position before opening the hood. If the ignition is in the RUN position and the Propulsion System is active when the hood is opened, the electric motor could automatically start, and persons not clear of the vehicle could be injured by the electric motor's moving parts.

The hood release lever (to open the primary latch) and safety latch (to open the secondary latch) must be released to open the hood.

1. Pull the hood release lever located under the driver's side of the instrument panel.

**Hood Release Lever**

2. Move to the outside of the front of the vehicle.

3. Push the safety latch release lever toward the passenger side of the vehicle. The safety latch is located behind the center front edge of the hood.

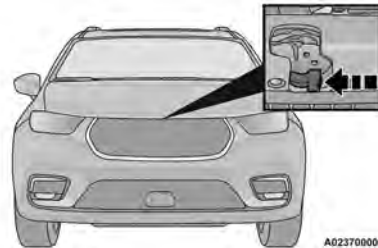

A0237000050US

**Safety Latch Release Lever Location**

4. Remove the support rod from the locking tab and insert it into the seat located on the underside of the hood.

**NOTE:**

- Vehicle must be at a stop and the gear selector must be in PARK.
- You may have to push down slightly on the hood before pushing the safety latch.
- While lifting the hood, use both hands.
- Before lifting the hood, check that the wiper arms are not in motion and not in the lifted position.
- **For Hybrid models:** If the vehicle was actively charging the high voltage battery when the hood was opened, the vehicle will stop charging until the hood is closed.

- **For Hybrid models:** Electric drive mode will not be available while the hood is open. A message will show in the instrument cluster display to alert the driver.

## CLOSING

1. Hold up the hood with one hand and with the other hand remove the support rod from its seat and reinsert it into the locking tab.
2. Lower the hood to approximately 12 inches (30 cm) from the engine compartment and drop it. Make sure that the hood is completely closed.

### NOTE:

**For PHEV models:** If the vehicle stopped charging the high voltage battery when the hood was opened, the vehicle will resume charging when the hood closes.

### WARNING!

Be sure the hood is fully latched before driving your vehicle. If the hood is not fully latched, it could open when the vehicle is in motion and block your vision. Failure to follow this warning could result in serious injury or death.

### CAUTION!

To prevent possible damage, do not slam the hood to close it. Lower hood to approximately 12 inches (30 cm) and drop the hood to close. Make sure hood is fully closed for both latches. Never drive vehicle unless hood is fully closed, with both latches engaged.

## LIFTGATE

### TO UNLOCK/OPEN THE LIFTGATE

The liftgate may be released in several ways:

- Key fob
- Liftgate Release Handle
- Button on overhead console

Push the liftgate button on the key fob twice within five seconds to release the liftgate.

The key fob and the overhead console button will release the liftgate when the liftgate is locked. The outside handle requires the liftgate to be unlocked. If the vehicle is equipped with Passive Entry, pulling the electronic liftgate release handle will unlock and release the liftgate, with a valid Passive Entry key fob within 5 ft (1.5 m) of the liftgate.



**Electronic Liftgate Release Handle**

### NOTE:

When you pull the electronic liftgate release handle, either only the liftgate will unlock, or all the doors and the liftgate will unlock, depending on the selected setting in the Uconnect system → page 169.

### TO LOCK/CLOSE THE LIFTGATE

To manually close the liftgate, grab the liftgate closing handle and pull in a downward motion.

### WARNING!

- Driving with the liftgate open can allow poisonous exhaust gases into your vehicle. You and your passengers could be injured by these fumes. Keep the liftgate closed when you are operating the vehicle.
- If you are required to drive with the liftgate open, make sure that all windows are closed, and the climate control blower switch is set at high speed. Do not use the recirculation mode.

### POWER LIFTGATE — IF EQUIPPED

The power liftgate may be opened or closed in several ways:

- Overhead console liftgate button
- Key fob
- Outside handle (open or reset liftgate latch)
- Rear Interior Power Liftgate button (when liftgate is open)
- Hands-Free Liftgate (if equipped) — opens liftgate only

Using the previously listed ways to open or close the liftgate:

- When the liftgate is fully closed, the liftgate will open
- When the liftgate is fully open, the liftgate will close
- When the liftgate is moving, the liftgate will reverse

Push the Power Liftgate button on the overhead console to open or close the liftgate.

Push the liftgate button on the key fob twice within five seconds to open or close the liftgate.



**Overhead Console Power Switches**

- 1 – Liftgate
- 2 – Left Sliding Door
- 3 – Sliding Door Power Off
- 4 – Right Sliding Door

The key fob and the overhead console button will operate the liftgate when the liftgate is locked. The outside handle requires the liftgate to be unlocked. If the vehicle is equipped with Passive Entry, pressing the touch pad on the outside handle or Hands-Free Liftgate foot activation (if equipped) will unlock and open the liftgate, with a valid Passive Entry key fob within 5 ft (1.5 m) of the liftgate handle.

**NOTE:**

- To open the liftgate, the Hands-Free Liftgate foot activation (if equipped) requires a valid Passive Entry key fob within 5 ft (1.5 m) of the door handle.
- When you pull the electronic liftgate release handle, either only the liftgate will unlock, or all the doors and the liftgate will unlock, depending on the selected setting in the Uconnect system.
- Tones are sounded and the turn signals are flashed with liftgate movements. These alerts can be turned on or off in Uconnect Settings ↩ page 169.

**To Close The Liftgate**

The liftgate can also be closed using the Rear Interior Power Liftgate button (if equipped), located in the upper left trim in the liftgate opening.

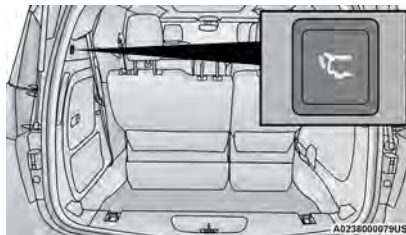

**Rear Interior Power Liftgate Button**

**NOTE:**

If the power liftgate will not fully open or latch close, check the latch for damage or obstacles that may be preventing the closing operation. If the problem persists, proceed as follows:

1. Press the electronic liftgate release handle on the outside of the liftgate to home/reset the latch mechanism.
2. Manually close the liftgate by pulling downward using the closing handle.
3. Resume normal power liftgate open or closing operation.

If the home/reset procedure is unsuccessful, see an authorized dealer for service.

**HANDS-FREE LIFTGATE – IF EQUIPPED**

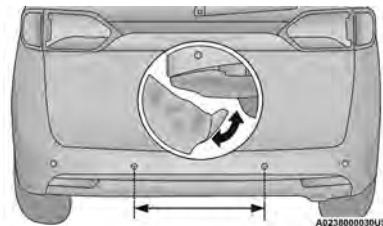

**Hands-Free Liftgate Activation Zone**

To open the liftgate using hands-free activation, use a straight in and out kicking motion under the vehicle activation zone in the general location below the liftgate door handle. You may also move your foot sideways or in a sweeping motion.

## Vehicles Equipped With A Trailer Tow Package

**NOTE:**

If your vehicle is equipped with the Trailer Tow Package, the hands-free activation zone(s) for the Power Liftgate will be located on the left and right side of the receiver. Use a straight kicking motion under either activation zone to open the Hands-Free Liftgate.

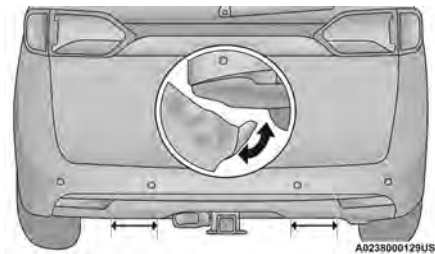

**Hands-Free Liftgate Trailer Tow Activation Zones**

When a valid kicking motion is completed, the liftgate will chime, the hazard lights will flash and the liftgate will open after approximately one second. This assumes all options are enabled in the Uconnect system.

**NOTE:**

To open the Hands-Free Liftgate requires a valid Passive Entry key fob within 5 ft (1.5 m) of the door handle. If a valid Passive Entry key fob is not within 5 ft (1.5 m), the liftgate will not respond to any kicks.

**CAUTION!**

The Hands-Free Liftgate feature may be turned on or off in Uconnect Settings. The Hands-Free Liftgate feature should be turned off during jacking, tire changing, and vehicle service → page 169.

**NOTE:**

- The Hands-Free Liftgate will only operate when the transmission is in PARK.
- If anything obstructs the Hands-Free Liftgate while it is opening or closing, the liftgate will automatically reverse to the closed position, provided it meets sufficient resistance.
- There are pinch sensors attached to the side of the liftgate opening. Light pressure anywhere along these strips will cause the liftgate to return to the open position.
- If the power liftgate encounters multiple obstructions within the same cycle, the system will automatically stop. If this occurs, the liftgate must be operated manually.
- The power liftgate will release, but not power open, in temperatures below  $-12^{\circ}\text{F}$  ( $-24^{\circ}\text{C}$ ). Be sure to remove any buildup of snow or ice from the liftgate before opening the liftgate.
- If the liftgate is left open for an extended period of time, the liftgate may need to be closed manually to reset power liftgate functionality.
- The Hands-Free Liftgate only works to open the liftgate.

**WARNING!**

- Driving with the liftgate open can allow poisonous exhaust gases into your vehicle. You and your passengers could be injured by these fumes. Keep the liftgate closed when you are operating the vehicle.
- If you are required to drive with the liftgate open, make sure that all windows are closed, and the climate control blower switch is set at high speed. Do not use the recirculation mode.

Gas props support the liftgate in the open position. However, because the gas pressure drops with temperature, it may be necessary to assist the props when opening the liftgate in cold weather.

**NOTE:**

Allow the power system to open the liftgate. Manually pushing or pulling the liftgate may activate the liftgate obstacle detection feature and stop the power operation or reverse its direction.

**WARNING!**

During power operation, personal injury or cargo damage may occur. Ensure the liftgate travel path is clear. Make sure the liftgate is closed and latched before driving away.

## CARGO AREA FEATURES

### Cargo Area Storage

When the third row seats are not in the stowed position, there is a large area for cargo storage.



Rear Cargo Area

#### NOTE:

With all rear seats stowed or removed, 4 x 8 ft (1.2 x 2.4 m) sheets of building material will fit on the vehicle floor with the liftgate closed. The front seats must be moved slightly forward of the rearmost position.

### Stow 'n Vac Integrated Vacuum — If Equipped

Your vehicle may be equipped with an integrated vacuum system. This vacuum is for in-vehicle use only and should only be used on dry materials and on in-vehicle surfaces. It is located in the rear trim panel behind the sliding door on the driver's side of the vehicle.

### IMPORTANT SAFETY INSTRUCTIONS

Read all instructions before using. When using your vacuum, basic precautions should be followed, including the following:

#### WARNING!

- Never leave children alone in a vehicle, or with access to an unlocked vehicle. Allowing children to be in a vehicle unattended is dangerous for a number of reasons. A child or others could be seriously or fatally injured. Children should be warned not to touch the parking brake, brake pedal or the gear selector.
- Do not leave the key fob in or near the vehicle, or in a location accessible to children, and do not leave the Keyless Enter 'n Go™ Ignition in either the ACC position, or engine running (ON), unless you are using the vacuum system. Be aware a child could operate power windows, other controls, or move the vehicle when the vacuum system is in use. ALWAYS push ignition button to place ignition in the OFF position when finished using the vacuum system.

#### WARNING!

To reduce the risk of fire, serious injury or death:

- Do not use vacuum while vehicle is in motion or while driving.
- Do not vacuum wet surfaces or any liquids.
- Do not use to vacuum up anything outside of the vehicle.



(Continued)

#### WARNING!

- Do not vacuum any flammable liquids, such as gasoline, or use around explosive vapors. Vapors from flammable liquids may form an explosive mixture with air and can be ignited by heat, sparks, or flames. Vapors may travel to a source of ignition and explode.
- Do not vacuum anything that is burning or smoking, such as cigarettes, matches, or hot ashes/embers.
- Do not allow to be used as a toy. Close attention is necessary when used by or near children.
- Do not leave the vacuum running while unattended.
- Use only as described in this manual. Use only attachments provided with your vehicle.
- Do not put any object into openings. Do not use with any opening blocked; keep free of dust, lint, hair, and anything that may reduce air flow.
- Do not vacuum toxic material such as chlorine bleach, ammonia, drain cleaner, etc.
- Do not vacuum hard or sharp objects such as glass, nails, screws, coins, etc.
- Keep hair, loose clothing, fingers, and all parts of body away from openings and moving parts.
- Only use with filter in place. Periodically check that the filter is in place and in good condition.



**WARNING!**

This equipment incorporates parts such as switches, motors, or the like that tend to produce arcs or sparks that can cause an explosion. When using your vacuum near gasoline-dispensing equipment or service stations, park vehicle at least 20 ft (6 m) away from the exterior enclosure of any dispensing pump. The vacuum is mounted more than 18 inches (45 cm) above ground level in your vehicle.

The vacuum will operate in two modes:

- **Ignition in the ACC position:** Engine remains off, and vacuum usage is limited to 10 minutes.
- **Ignition in the START position:** Engine is running, and vacuum usage is unlimited until the vehicle's battery level falls below 60%.

**NOTE:**

The vacuum will not operate when the ignition is in the OFF position, or in the ON/RUN position with the engine off. For more information on ignition positions, see  page 23.

## 1. Before Using Vacuum:

**Accessory (ACC) Mode Operation - For up to 10 minutes of operation**

Always apply the parking brake, shift the transmission into PARK, and push ignition button to place ignition in Accessory (ACC) mode. The engine will not be running in this mode. Do not leave the key fob in or near the vehicle, or in a location accessible to children.

**NOTE:**

The vacuum system will run for 10 minutes off battery power and then the vacuum will shut down. A low battery indication light (LOW PWR) located below the vacuum nozzle storage location will come on one minute before the vacuum shuts down.

**Engine Running (START) Operation - For more than 10 minutes of operation**

- Position vehicle outdoors and fully open all side windows.
- Always apply the parking brake, shift the transmission into PARK, and leave engine running.

**WARNING!**

Carbon monoxide (CO) in exhaust gases can cause serious injury or death. Follow these precautions to prevent carbon monoxide poisoning:

- Do not inhale exhaust gases.
- Do not start or run an engine in a closed garage or confined area. Always position vehicle outdoors and fully open all side windows before using vacuum system with the engine running.
- Guard against carbon monoxide with proper maintenance. Have the exhaust system inspected every time the vehicle is raised. Have any abnormal conditions repaired promptly.

2. Unclip the vacuum nozzle and pull to extend vacuum hose from the storage location.

**NOTE:**

The hose can reach every corner of the vehicle floor.

3. Install desired attachment if needed.

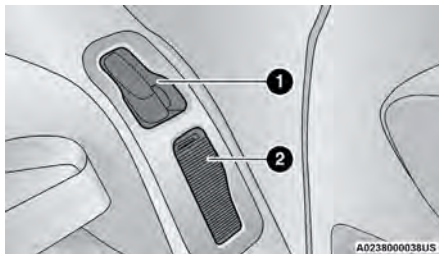
**Front Storage Compartments**

- 1 – Vacuum Nozzle Storage Location
- 2 – Attachment Compartment

**NOTE:**

To access crevice or upholstery attachments, open the front Attachment Compartment.

- **Crevice Tool** – Able to reach into tight spaces including the seat latches located in the floor.
- **Upholstery Tool** – Use to agitate dirt and debris from carpets and seats. This tool can also be used to pick up pet hair.
- **Hose Extension** – Use to add another 12 ft (3.6 m) of usable length to the vacuum hose. Hose extension is provided in a bag attached to a grocery hook behind the third row seat on the driver's side.

4. Push the vacuum on/off button  located under the vacuum nozzle storage location. Use vacuum as needed.

**NOTE:**

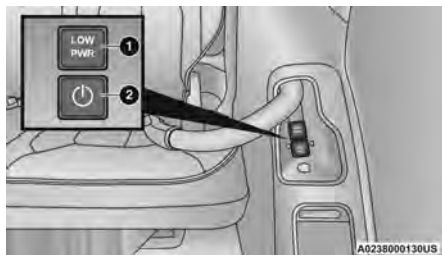

- When the vacuum is ON, the LED indicator on the on/off button will illuminate.
- When the vacuum is OFF, the LED indicator will also be off.
- After nine minutes of operation in ACC mode (engine not running), the Low Power Indicator Light (LOW PWR) will illuminate.

**Power Buttons**

- 1 — Low Power Indicator Light  
2 — On/Off Button

**WARNING!**

For in vehicle use ONLY. To reduce the risk of fire, serious injury or death:

- Do not use vacuum while vehicle is in motion or while driving. 
- Do not vacuum wet surfaces or any liquids.
- Do not use to vacuum up anything outside of the vehicle.
- Do not vacuum any flammable liquids, such as gasoline, or use around explosive vapors. Vapors from flammable liquids may form an explosive mixture with air and can be ignited by heat, sparks, or flames. Vapors may travel to a source of ignition and explode.
- Do not vacuum anything that is burning or smoking, such as cigarettes, matches, or hot ashes/embers. 
- Do not allow to be used as a toy. Close attention is necessary when used by or near children.
- Do not leave the vacuum running while unattended.
- Use only as described in this manual. Use only attachments provided with your vehicle.
- Do not put any object into openings. Do not use with any opening blocked; keep free of dust, lint, hair, and anything that may reduce air flow.
- Do not vacuum toxic material such as chlorine bleach, ammonia, drain cleaner, etc.
- Do not vacuum hard or sharp objects such as glass, nails, screws, coins, etc.

*(Continued)***WARNING!**

- Keep hair, loose clothing, fingers, and all parts of body away from openings and moving parts.
- Only use with filter in place. Periodically check that the filter is in place and in good condition.

**2****WARNING!**

This equipment incorporates parts such as switches, motors, or the like that tend to produce arcs or sparks that can cause an explosion. When using your vacuum near gasoline-dispensing equipment or service stations, park vehicle at least 20 ft (6 m) away from the exterior enclosure of any dispensing pump. The vacuum is mounted more than 18 inches (45 cm) above ground level in your vehicle.

5. When finished, push power button to turn vacuum off and store vacuum hose and any attachments.
6. Before exiting the vehicle:
  - If the ignition is in the ACC position, push the START/STOP ignition button to place ignition in the OFF position, remove key fob from the vehicle, and lock the vehicle.
  - If the engine is running, raise all of the windows, push the START/STOP ignition button to place ignition in the OFF position, remove key fob from the vehicle, close all of the doors and the lift-gate and lock the vehicle.

**Vacuum Troubleshooting**

- DO NOT use with any opening blocked. If an object becomes lodged in the hose, attempt to fully extend the hose in a straight line while the vacuum motor is running. If this does not dislodge the object, turn the vacuum OFF and remove the hose from the vehicle using the subsequent removal instructions. If the filter is clogged, follow the emptying debris bin procedure and lightly tap the filter on the collection bin to remove any collected debris from the filter. Both the bin and the filter can be rinsed with water if needed. To avoid mold and stale odors, allow both to dry completely before reinstalling in your vehicle. If the filter has tears, holes or other damage and needs to be replaced, please contact an authorized dealer.
- If there are any other issues with your vacuum, contact an authorized dealer. Your vacuum has no user serviceable parts.

**Debris Bin**

The debris bin is located behind the access panel behind the third row seat on the driver's side.

**To Empty**

1. Push power button to turn vacuum OFF.
2. Open the access panel by pulling the finger grip towards you and then pull downward.

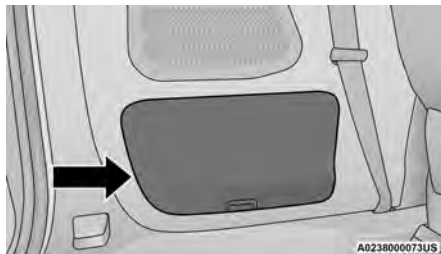
**Vacuum System Access Panel**

3. Twist the release knob counterclockwise and pull the bin towards you.

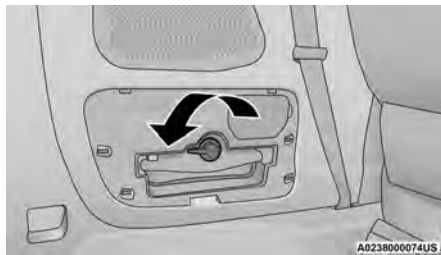
**Debris Bin Release Knob**

4. Remove the filter and dump the debris in a trash can. Lightly tap the filter on the collection bin to remove loose debris from the filter. If the filter is clogged from extended use, have the filter replaced by an authorized dealer.
5. Reverse the procedure to reinstall.

**NOTE:**

The debris bin must be fully installed and locked for the vacuum to function properly.

**Hose Access Port**

The hose access port is located behind the access panel behind the third row seat on the driver's side.

**To Remove Vacuum Hose For Cleaning**

1. Open the access panel.

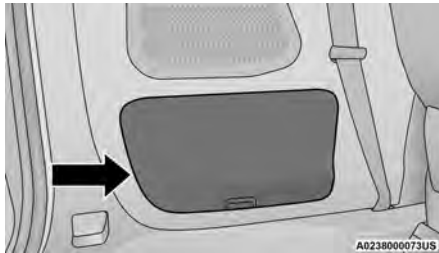
**Vacuum System Access Panel**



- Open the small access panel on the upper right side, and unclip the hose from the hose access port by pushing the yellow vacuum hose release lever with right thumb and lifting the hose with index finger.

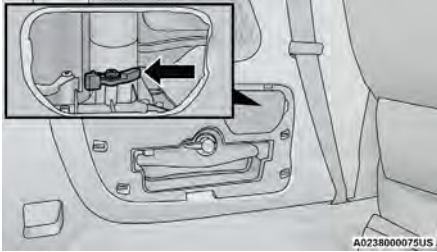

**Vacuum Hose Release Lever**

- Return to vacuum nozzle storage location located behind the sliding door.
- Grab the vacuum nozzle and gently pull the hose out through vacuum nozzle storage location.
- Shake the hose to remove any objects stuck in the hose. Take care not to perforate the hose while attempting to dislodge any objects.
- Reverse the procedure to reinstall and clip the hose into place.

## STOW 'N PLACE ROOF RACK — IF EQUIPPED

The crossbars and side rails are designed to carry weight on vehicles equipped with a luggage rack. **The load must not exceed 150 lb (68 kg), and should be uniformly distributed over the luggage rack crossbars.**

The crossbars on your vehicle are delivered stowed within the roof rack side rails. Crossbars should always be used whenever cargo is placed on the roof rack. Check the straps frequently to be sure that the load remains securely attached.

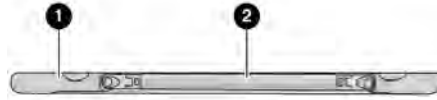

**Roof Rack**

- Side Rail
- Crossbar

The Stow 'n Place roof rack does not increase the total load carrying capacity of the vehicle. Be sure the total load of cargo inside the vehicle plus that on the external rack does not exceed the maximum vehicle load capacity.

## DEPLOYING THE CROSSBARS

- To deploy the crossbars, completely loosen the thumb screws at both ends of the crossbar and lift the crossbar from its stowed position in the side rail. Repeat with crossbar on the opposite side.

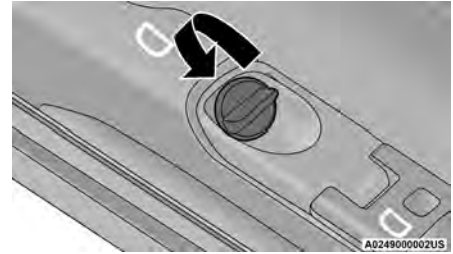

**Thumb Screw**

### NOTE:

The thumb screws cannot be fully removed.

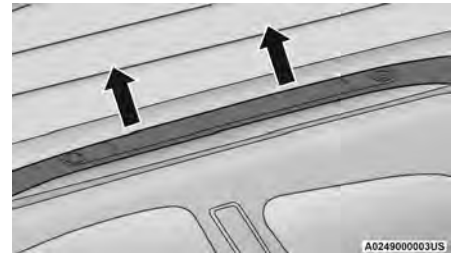

**Removing Crossbars**

**CAUTION!**

Use care when removing and handling the crossbars to prevent damage to the vehicle.

- Bend the crossbar supports at each end, taking care to keep hand clear of pivoting joint. Slide the thumb screw down.



A0249000004US

**Bending Pivot**

- Position the crossbars across the roof making sure the letters on the crossbars align with the matching letters on the side rail.

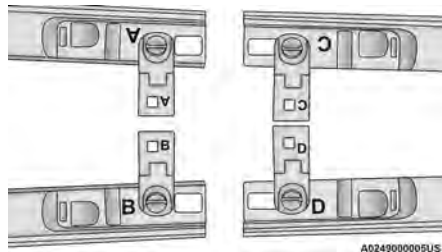

A0249000005US

**Positioning Crossbars**

- Once the crossbar is in place, tighten both thumb screws completely.

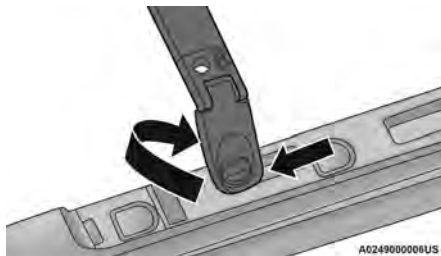

A0249000006US

**Installing Crossbars**

- Deploy and tighten the second crossbar to complete the deployment of the crossbars.

**NOTE:**

The crossbars are not identical and have fixed deployment positions. Rear crossbar can be deployed in two different positions.

**STOWING THE CROSSBARS**

- Starting with one crossbar, completely loosen the thumb screws at both ends. Lift the crossbar away from the matching letter to remove it from the deployed position. Repeat with the other crossbar.

**CAUTION!**

Use care when removing and handling the crossbars to prevent damage to the vehicle.

- Starting with the one crossbar, bend up the pivot supports at each end.



A0249000004US

**Crossbar Pivot**

3. Then, position the crossbar along the correct side rail. Make sure the letters on the crossbar align with the matching letters on the side rail.

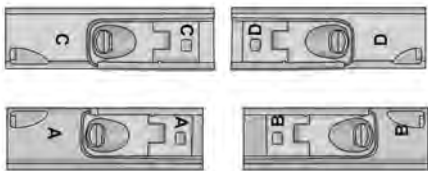

A0249000009US

#### Stowing Crossbars

4. The crossbar will nest fully within the side rail.

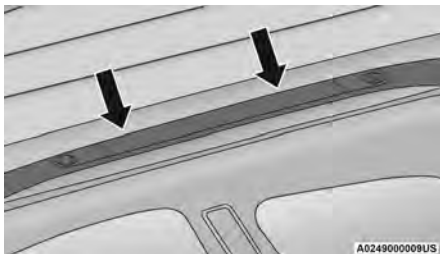

A0249000009US

#### Crossbar To Side Rail

5. Once the driver's side crossbar is in place, tighten the thumb screws completely.

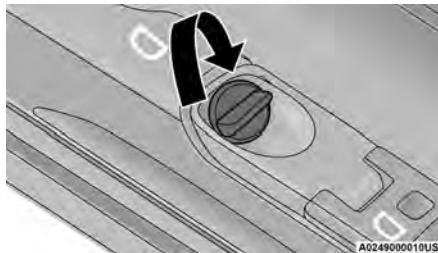

A0249000010US

#### Tightening Crossbar

6. Repeat the procedure to stow the second crossbar on the opposite side.



A0249000011US

#### Stowed Crossbars

#### NOTE:

- To help control wind noise, stow the crossbars in the side rails when they are not in use.
- If any metallic object is placed over the satellite radio antenna (if equipped), you may experience interruption of satellite radio reception.

#### WARNING!

Cargo must be securely tied down before driving your vehicle. Anything improperly secured to the roof rack, crossbars, or the roof itself can fly off the vehicle, particularly at high speeds, resulting in collisions, personal injury, or property damage. Follow the roof rack cautions when carrying anything on your roof rack.

#### CAUTION!

- To prevent damage to the roof of your vehicle, DO NOT carry any loads on the roof rack without the crossbars deployed. The load should be secured and placed on top of the crossbars, not directly on the roof. If it is necessary to place the load on the roof, place a blanket or other protective layer between the load and the roof surface.
- To avoid damage to the roof rack and vehicle, do not exceed the maximum roof rack load capacity of 150 lb (68 kg). Always distribute heavy loads as evenly as possible and appropriately secure the load and any protective layer placed between the load and the roof surface.

(Continued)

**CAUTION!**

- Load should always be secured to cross bars first, with tie down loops used as additional securing points if needed. Tie loops are intended as supplementary tie down points only. Do not use ratcheting mechanisms with the tie loops. Check the straps and thumb wheels frequently to be sure that the load remains securely attached.
- Long loads that extend over the windshield, such as wood panels or surfboards, or loads with large frontal area should be secured to both the front and rear of the vehicle.
- Travel at reduced speeds and turn corners carefully when carrying large or heavy loads on the roof rack. Wind forces, due to natural causes or nearby truck traffic, can add sudden upward lift to a load. This is especially true on large flat loads and may result in damage to the cargo or your vehicle.

# GETTING TO KNOW YOUR INSTRUMENT PANEL

## INSTRUMENT CLUSTER

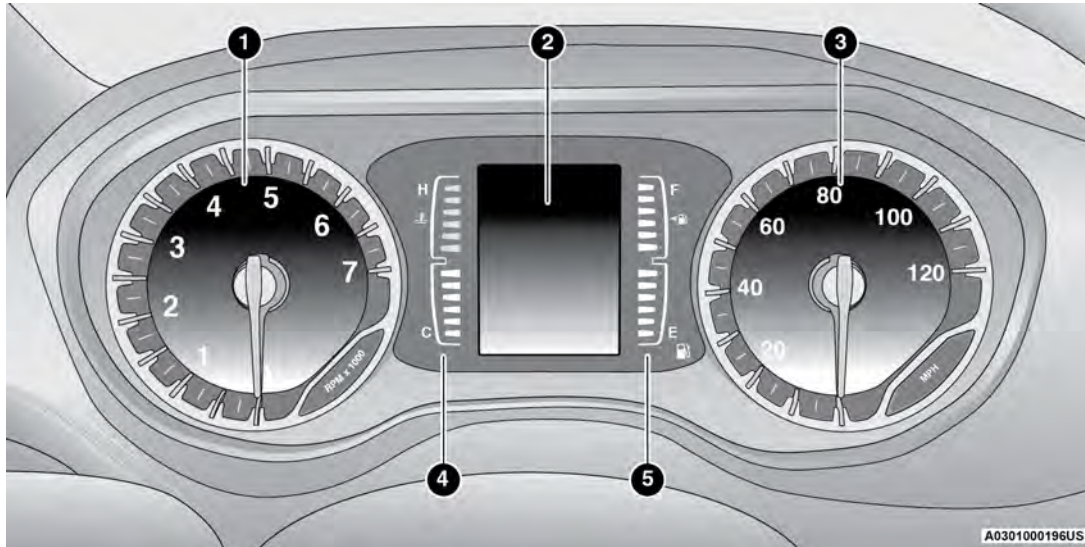

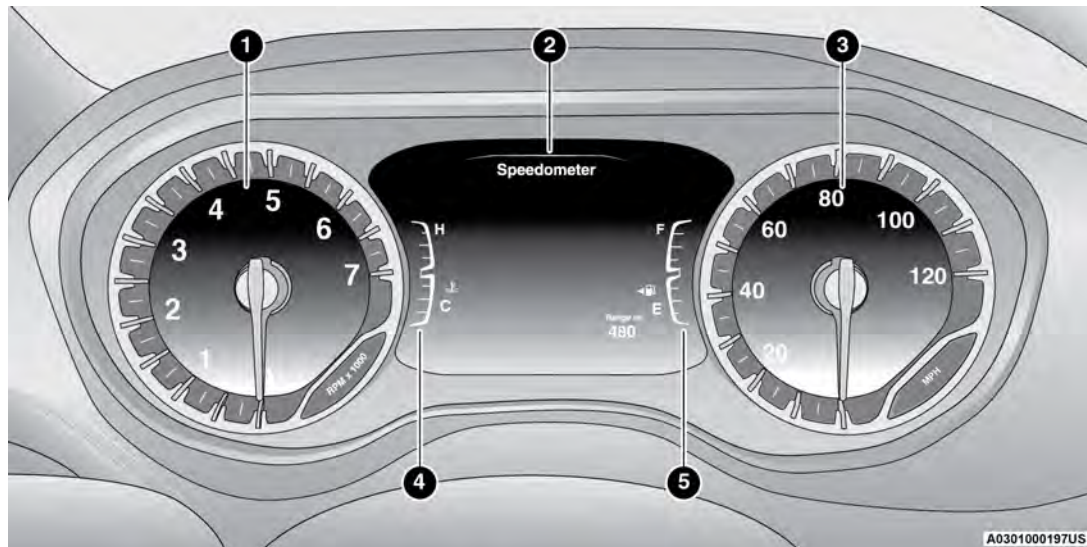

Use this QR code to access your digital experience.



## INSTRUMENT CLUSTER DESCRIPTIONS

1. Tachometer
  - Indicates the engine speed in revolutions per minute (RPM x 1000).
2. Instrument Cluster Display
  - When the appropriate conditions exist, this display shows the instrument cluster display messages → page 103.
  - The display shows one of the main menu items after the ignition is turned/placed on.
3. Speedometer
  - Indicates vehicle speed.
4. Temperature Gauge
  - The temperature gauge shows engine coolant temperature. Any reading within the normal range indicates that the engine cooling system is operating satisfactorily.
  - The gauge can indicate a higher temperature when driving in hot weather or up mountain grades. It should not be allowed to exceed the upper limits of the normal operating range.

### WARNING!

A hot engine cooling system is dangerous. You or others could be badly burned by steam or boiling coolant. You may want to call an authorized dealer for service if your vehicle overheats → page 276.

### CAUTION!

Driving with a hot engine cooling system could damage your vehicle. If the temperature gauge reaches "H" pull over and stop the vehicle. Idle the vehicle with the air conditioner turned off until the gauge drops back into the normal range and is no longer red. If the gauge remains on the "H", turn the engine off immediately and call an authorized dealer for service.

### 5. Fuel Gauge

- The gauge shows the level of fuel in the fuel tank when the ignition switch is in the ON/RUN position.
- The fuel pump symbol points to the side of the vehicle where the fuel door is located.



### NOTE:

The hard telltales will illuminate for a bulb check when the ignition is first cycled.

## INSTRUMENT CLUSTER — HYBRID MODELS

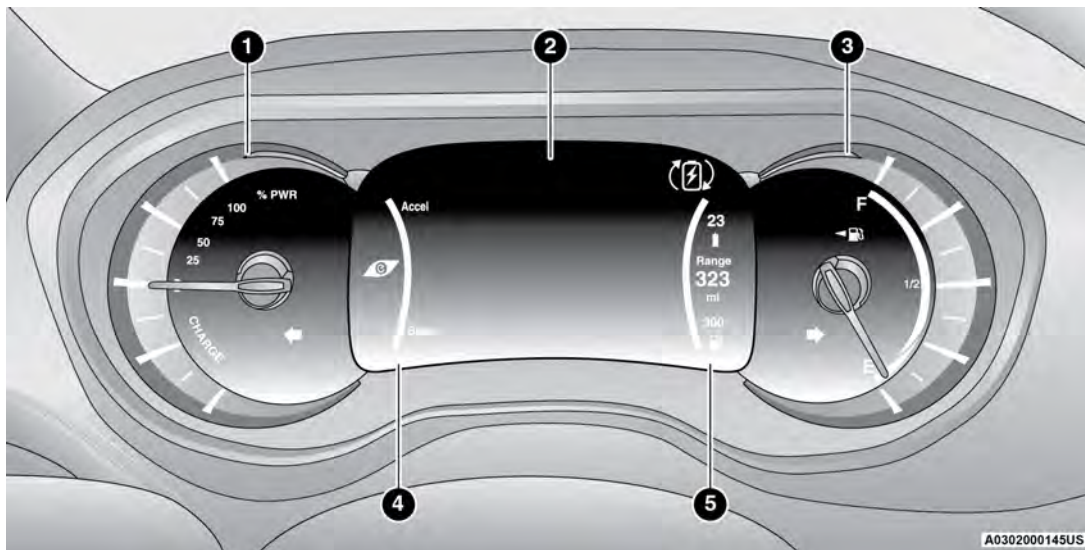





## INSTRUMENT CLUSTER DESCRIPTIONS

### 1. % Power Gauge

- Indicates vehicle power. The upper half of the gauge is a summation of the engine and high voltage battery power applied to move the vehicle. Bottom half indicates when the high voltage battery is charging via regenerative braking, while slowing the vehicle down.

### 2. Instrument Cluster Display

- The instrument cluster display features a driver interactive display. When the appropriate conditions exist, this display shows messages  page 103.
- Max Regeneration symbol appears in the upper right corner of the Instrument Cluster Display when you are driving at the maximum efficiency  page 117.



### 3. Fuel Gauge

- The gauge shows the level of fuel in the fuel tank when the ignition switch is in the ON/RUN position.
- The fuel pump symbol points to the side of the vehicle where the fuel door is located.



### 4. Left Reconfigurable Screen With Four Customer Programmable Options

- Efficiency Coach: This gauge provides visual awareness on how to achieve maximum energy efficiency while driving. When accelerating and braking, the most efficient operation will be represented with the gauge color being green. Less efficient operation will be represented by yellow, followed by orange, as the level of efficiency decreases.
- Charge/Power: This gauge represents the source of the power utilized to accelerate the vehicle. The teal outer ring represents the High Voltage (HV) battery output during acceleration, and input power during regeneration. The blue inner ring represents the engine output power.
- Energy Economy: this gauge represents the combined MPG (or km/L, or L/100km) obtained through engine use and MPG (or km/L, or L/100km) equivalent obtained through HV battery use. The outer ring represents current energy economy. The white inner ring represents average energy economy.
- NONE

### 5. Right Reconfigurable Screen With Four Customer Programmable Options

- EV Range & Battery %: shows values for electric range and battery %, along with a teal gauge showing battery % (state of charge <1 to 100%).
- Electric Range: shows the vehicle's electric range capability, based on the High Voltage Battery State of Charge (state of charge <1 to 100%).

- All Range Values: shows values for electric, hybrid and total range, along with a white gauge showing the total range.
- NONE

## INSTRUMENT CLUSTER DISPLAY

Your vehicle is equipped with an instrument cluster display, which offers useful information to the driver. With the ignition in the OFF position (and the key removed, for vehicles with mechanical key), opening/closing of a door will activate the display for viewing, and display the total miles or kilometers in the odometer. Your instrument cluster display is designed to display important information about your vehicle's systems and features. Using a driver interactive display located on the instrument panel, your instrument cluster display can show you how systems are working and give you warnings when they are not. The steering wheel mounted controls allow you to scroll through and enter the main menus and submenus. You can access the specific information you want and make selections and adjustments.

## INSTRUMENT CLUSTER DISPLAY LOCATION AND CONTROLS

The Instrument Cluster Display is located in the center of the instrument cluster.

The system allows the driver to select information by pushing the following buttons mounted on the steering wheel:

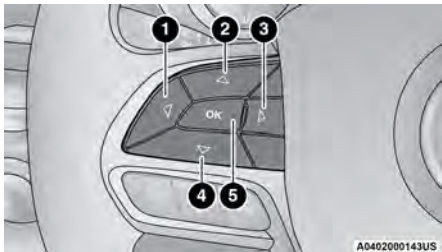

**Instrument Cluster Display Control Buttons**

- 1 – Left Arrow Button
- 2 – Up Arrow Button
- 3 – Right Arrow Button
- 4 – Down Arrow Button
- 5 – OK Button

- **Back/Left Arrow Button**

Push and release the **left** ◀ arrow button to access the information screens or submenu screens of a main menu item.

- **Up Arrow Button**

Push and release the **up** ▲ arrow button to scroll upward through the Main Menu items.

- **Right Arrow Button**

Push and release the **right** ▶ arrow button to access the information screens or submenu screens of a main menu item.

- **Down Arrow Button**

Push and release the **down** ▼ arrow button to scroll downward through the Main Menu items.

- **OK Button**

Push the **OK** button to access/select the information screens or submenu screens of a Main Menu item. Push and hold the **OK** arrow button for one second to reset displayed/selected features that can be reset.

### STOP SAFELY VEHICLE WILL SHUT OFF SOON



#### **Stop Safely Vehicle Will Shut Off Soon Warning Message**

This warning will be displayed on the instrument panel display when the vehicle has determined an operational issue will occur shortly, which will cause the vehicle's propulsion system to turn off.

If the light turns on while driving, stop the vehicle in a safe location as soon as possible. Have the vehicle transported to an authorized dealer.

- This is a high priority message
- This message will be displayed continuously
- Cannot be cleared with button press
- A single chime will sound

### STOP SAFELY AND LEAVE THE VEHICLE AS SOON AS POSSIBLE



#### **Stop Safely And Leave The Vehicle As Soon As Possible Warning Message**

A warning will appear on the instrument panel display if the system detects the high voltage battery has overheated. This can result in a vehicle fire, and the release of toxic and/or flammable gases. To reduce the risk of a larger fire, the vehicle's high voltage propulsion system will turn off within thirty seconds of displaying this warning. At that time, the vehicle may not accelerate. You can still steer and brake the vehicle.

- This message will be displayed continuously
- Cannot be cleared with button press
- A continuous and rapid chime will sound. Stop and park the vehicle in an open area. Have all passengers exit the vehicle as soon as possible and move to a safe distance away from the vehicle. After all passengers safely exit the vehicle, call emergency responders immediately. Even if you do not see flames, a fire may start at any moment, so do not attempt to re-enter or start the vehicle.

## ENGINE OIL LIFE

Use this QR code to access your digital experience.



- Your vehicle is equipped with an engine oil change indicator system. The “Oil Change Required” message will display for approximately five seconds after a single chime has sounded, to indicate it is time to change the engine oil. The engine oil change indicator system is duty cycle based, which means the engine oil change interval may fluctuate, dependent upon your personal driving style.
- Unless reset, this message will continue to display each time the ignition is cycled to the ON/RUN position.
- To reset the oil change indicator after performing the scheduled maintenance, refer to the following procedure.

### NOTE:

This procedure should only be performed after scheduled maintenance is completed. Resetting oil life other than when associated with a scheduled maintenance may result in damage due to not properly maintaining the engine oil.

#### Oil Life Reset

1. Without pressing the brake pedal, push the ENGINE START/STOP button and place the ignition in the ON/RUN position (do not start the vehicle.)
2. Push the **OK** button to enter the instrument cluster display menu screen.
3. Push and release the **down** ▾ arrow button to access the “Vehicle Info” menu screen.
4. Push the **left** ◀ arrow button or **right** ▶ arrow button to access the “Oil Life” submenu.
5. Hold the **OK** button to reset the “Oil Life” to 100%.
6. Push the **up** ▲ arrow button to exit the instrument cluster display menu screen.

#### Secondary Method For Oil Life Reset Procedure

1. Without pushing the brake pedal, place the ignition in the ON/RUN position (do not start the engine).
2. Fully press the accelerator pedal, slowly, three times within 10 seconds.
3. Without pushing the brake pedal, place the ignition in the OFF position.

### NOTE:

If the indicator message illuminates when you start the vehicle, the oil change indicator system did not reset. If necessary, repeat this procedure.

## INSTRUMENT CLUSTER DISPLAY MENU ITEMS

The instrument cluster display can be used to view the main menu items for several features. Use the **up** ▲ and **down** ▾ arrow buttons to scroll through the driver interactive display menu options until the desired menu is reached ↪ page 103.

### NOTE:

The instrument cluster display menu items display in the center of the instrument cluster. Menu items may vary depending on your vehicle features.

## Speedometer

Push and release the **up** ▲ or **down** ▾ arrow button until Speedometer is highlighted in the instrument cluster display. Push and release the **OK** button to toggle between MPH and km/h.

## Vehicle Info

Push and release the **up** ▲ or **down** ▾ arrow button until Vehicle Info is highlighted in the instrument cluster display. Push the **left** ◀ or **right** ▶ arrow button to scroll through the following information submenus:

### Tire Pressure Monitor

If tire pressure is correct for all tires, a vehicle icon is displayed with tire pressure values in each corner of the ICON.

If one or more tires have low pressure, “Inflate Tire To XX” is displayed with the vehicle ICON, and the tire pressure values in each corner of the ICON with the pressure value of the low tire displayed in a different color than the other tire pressure value.

If the Tire Pressure system requires service, “Service Tire Pressure System” is displayed.

Tire PSI is an information only function and cannot be reset ↩ page 205.

#### Coolant Temp

Displays the actual coolant temperature.

#### Transmission Temp

Displays the actual transmission temperature.

#### Oil Temp — If Equipped

Displays the actual oil temperature.

#### Oil Pressure

Displays the actual oil pressure.

#### Oil Life

Displays the remaining engine oil life as a percentage.

To reset the Oil Life, you must hold the **OK** button. The “Hold OK to Reset” instruction will be displayed at all times, but the following conditions will need to be met in order to reset Oil Life:

- The ignition must be in the ON/RUN position.

If the conditions are met, holding the **OK** button will reset the gauge and the numeric display will return to 100%.

If the conditions are not met, a pop-up message will display for five seconds, describing the required conditions, and then the Oil Life screen will reappear.

#### Battery Voltage

Displays the actual battery voltage.

#### Engine Hours — If Equipped

Displays the number of hours of engine operation.

## Driver Assist — If Equipped

Push and release the **up**  $\triangle$  or **down**  $\nabla$  arrow button until Driver Assist is highlighted in the instrument cluster display.

#### Adaptive Cruise Control and LaneSense:

- Driver Assist Screen shows the current status of both the ACC and the LaneSense systems
- Pop-up messages also indicate the status of the system and/or the conditions that need to be met

#### Adaptive Cruise Control (ACC) Feature

The instrument cluster display will show the current ACC system settings. The information displayed depends on ACC system status. Push the Adaptive Cruise Control (ACC) on/off button (located on the steering wheel) until one of the following displays in the instrument cluster display:

- Adaptive Cruise Control Off: when ACC is deactivated, the display will read “Adaptive Cruise Control Off.”
- Adaptive Cruise Control Ready: when ACC is activated but the vehicle speed setting has not been selected, the display will read “Adaptive Cruise Control Ready.” Push the SET + or the SET- button (located on the steering wheel).

#### ACC SET

When ACC is set, the set speed will display in the instrument cluster.

The ACC screen may display once again if any ACC activity occurs, which may include any of the following:

- Distance Setting Change
- System Cancel
- Driver Override

- System Off
- ACC Proximity Warning
- ACC Unavailable Warning

For further information, refer to “Adaptive Cruise Control (ACC) — If Equipped” in “Starting And Operating” in the Owner’s Manual.

#### LaneSense — If Equipped

The instrument cluster displays the current LaneSense system settings. The information displayed depends on LaneSense system status and the conditions that need to be met.

For further information, refer to “LaneSense — If Equipped” in “Starting And Operating” in the Owner’s Manual.

## Hybrid Info

Push and release the **up**  $\triangle$  or **down**  $\nabla$  arrow button until Hybrid Info is highlighted in the instrument cluster display. Push the **left**  $\triangleleft$  or **right**  $\triangleright$  arrow button to scroll through the following information submenus:

#### Energy Economy

- Average MPG gauge + value (hold OK to reset)
- Current Energy Economy gauge + value
- Total Range

#### Range to Empty

- Electric Range
- Hybrid Range
- Total Range

### Efficiency Coach

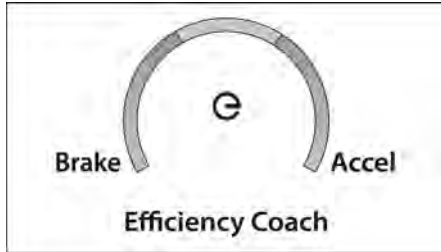

**Efficiency Coach Gauge**

Efficiency Coach will monitor your current driving to help you drive as efficient as possible.

- “Accel” is based on amount of acceleration (Different from MPG).
  - The gauge will only move up when accelerator pedal is pushed (or accelerating with Cruise Control or ACC).
  - Above a certain rate of change will be considered inefficient.
  - The color of the gauge bar will change from green to yellow to orange.
- “Brake” is based on amount of deceleration (slowing down).
  - The gauge will only move down when brake pedal is pushed (or decelerating with Cruise Control or ACC).
  - The color of the gauge bar will change from green to yellow to orange.

- The gauge bar color will transition smoothly up and down, and have a gradual change based on efficiency.
  - Center of gauge is 0% Accel and 0% Brake.
  - +/-0-35% of gauge fills green, +/-36-80% yellow, and +/-81-100% orange (with a blend between each color).
- When Rotary Shifter is shifted to L:
  - Max Regen Telltale is displayed in the upper right hand corner of the instrument cluster
  - Max Regeneration ON' Message is displayed for 5 seconds

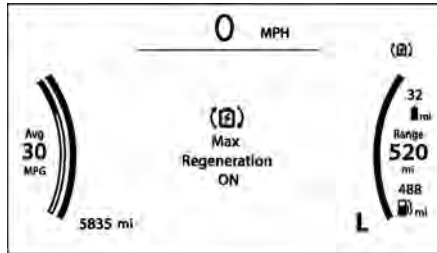

**Max Regen Cluster Message**

#### NOTE:

While attempting to shift into L, if “vehicle speed is too high to shift to L” message is displayed, the Max Regen ON/OFF message/TT should not be Displayed ↪ page 103

- When Rotary Shifter is shifted back to P/R/N/D:
  - Max Regen Telltale goes away
  - Max Regeneration OFF Message is displayed for 5 seconds

#### NOTE:

While attempting to shift out of L, if “vehicle speed is too High to shift to P (or R)” message is displayed, the Max Regen OFF/ON message should not be displayed. The Telltale should continue to display as long as the vehicle is in L gear.

### Charge/Power

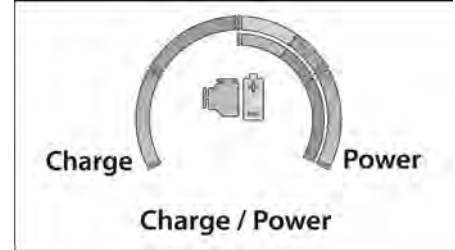

**Charge/Power Gauge**

- Charging is represented by the gauge filling on the left hand side.
- Power is represented by the gauge filling on the right hand side.

## Fuel Economy

Push and release the **up**  $\triangle$  or **down**  $\nabla$  arrow button until the Fuel Economy Menu item is highlighted in the instrument cluster display. The Fuel Economy Menu will display the following:

- Two submenu pages that can be toggled between using the **left**  $\triangleleft$  and **right**  $\triangleright$  arrow buttons; one with Current Value displayed and one without the Current Value displayed:
  - Average Fuel Economy (MPG, L/100 km, or km/L)
  - Range To Empty (miles or km)
  - Current Fuel Economy (MPG, L/100 km, or km/L)
  - The Max and Min values will correspond to the particular engine requirements
- Hold **OK** to reset average fuel economy information.

## Trip Info

### TRIP INFO GASOLINE

Push and release the **up**  $\triangle$  or **down**  $\nabla$  arrow button until the Trip Menu item is highlighted in the instrument cluster display. Push the **left**  $\triangleleft$  or **right**  $\triangleright$  arrow button to scroll through the Trip A and Trip B submenus. The Trip information will display the following:

- Distance
- Average Fuel Economy
- Elapsed Time

Hold the **OK** button to reset feature information.

### TRIP INFO PHEV

Push and release the **up**  $\triangle$  or **down**  $\nabla$  arrow button until Trip Info is highlighted in the instrument cluster display. Push the **left**  $\triangleleft$  or **right**  $\triangleright$  arrow button to scroll through the Trip A and Trip B submenus. The Trip information will display the following:

#### Trip A

- Distance Electric
- Distance Hybrid
- Distance Total
- Average Energy Economy
- Elapsed Time

Hold the **OK** button to reset feature information.

#### Trip B

- Distance Electric
- Distance Hybrid
- Distance Total
- Average Energy Economy
- Elapsed Time

Hold the **OK** button to reset feature information.

## Stop / Start – If Equipped

Push and release the **up**  $\triangle$  or **down**  $\nabla$  arrow button until the Stop/Start menu title is displayed in the instrument cluster display.

## Audio

Push and release the **up**  $\triangle$  or **down**  $\nabla$  arrow button until the Audio Menu displays in the instrument cluster display.

## Messages

Push and release the **up**  $\triangle$  or **down**  $\nabla$  arrow button until Messages is highlighted in the instrument cluster display. This feature shows the number of stored warning messages. Pushing the **right**  $\triangleright$  arrow button will allow you to see what the stored messages are.

### NOTE:

The pop-up messages indicate the status of the system and/or the conditions that need to be met. Messages remain in the stored stack until condition is cleared.

## Screen Setup

Push and release the **up**  $\triangle$  or **down**  $\nabla$  arrow button until the Screen Setup Menu displays in the instrument cluster display. Push and release the **OK** button to enter the submenus. The Screen Setup feature allows you to change what information is displayed in the instrument cluster as well as the location that information is displayed.

### BASE INSTRUMENT CLUSTER DISPLAY SCREEN SETUP OPTIONS

Push and release the **up**  $\triangle$  or **down**  $\nabla$  arrow button until the Screen Setup Menu displays in the instrument cluster display. Push and release the **OK** button to enter the submenus. The Screen Setup feature allows you to change what information is displayed in the instrument cluster as well as the location that information is displayed.

Upper Left or Upper Right		
None	Compass (If Equipped)	Outside Temp
Average (MPG, L/100km, or km/L)	Time	Range
Current (MPG, L/100km, or km/L)		

Center		
None	Compass (If Equipped)	Outside Temp
Average (MPG, L/100km, or km/L)	Range	Time
Current (MPG, L/100km, or km/L)	Trip A Distance	Trip B Distance
Audio	Menu Title	Digital Speed

**Defaults**

- Restore
- Cancel

### PREMIUM INSTRUMENT CLUSTER DISPLAY SCREEN SETUP OPTIONS

Lower Left or Lower Right		
None	Compass (If Equipped)	Outside Temp
Time	Range to Empty	Average (MPG, L/100km, or km/L)
Trip A Distance	Trip B Distance	Current (MPG, L/100km, or km/L)

Upper Center		
None	Compass (If Equipped)	Outside Temp
Time	Range to Empty	Average (MPG, L/100km, or km/L)
Trip A Distance	Trip B Distance	Current (MPG, L/100km, or km/L)
Audio/Phone	Digital Speed	Menu Title

**Odometer**

- Show
- Hide

**Defaults**

- Restore
- Cancel

### PHEV INSTRUMENT CLUSTER DISPLAY SCREEN SETUP OPTIONS

Left Side		
None	Energy Economy	Efficiency Coach
Charge/ Power		

Right Side		
None	Battery % & Range	Electric Range
Charge/ Power	All (3) Range Values	

Upper Left and Upper Right		
None	Compass (If Equipped)	Outside Temp
Time	Average MPG (or "L/100km", or "km/L")	Current MPG (or "L/100km", or "km/L")
Trip A (Total Distance)	Trip B (Total Distance)	Battery %
Total Range	Electric Range	Hybrid Range

**Odometer**

- Show
- Hide (unless door open)

**Defaults**

- Restore
- Cancel

## BATTERY SAVER ON/BATTERY SAVER MODE MESSAGE — ELECTRICAL LOAD REDUCTION ACTIONS — IF EQUIPPED

This vehicle is equipped with an Intelligent Battery Sensor (IBS) to perform additional monitoring of the electrical system and status of the vehicle battery.

In cases when the IBS detects charging system failure, or the 12 Volt vehicle battery conditions are deteriorating, electrical load reduction actions will take place to extend the driving time and distance of the vehicle. This is done by reducing power to or turning off non-essential 12 Volt electrical loads. Load reduction will be functional when the vehicle propulsion system is active.

The vehicle may not be running depending on the High Voltage (HV) battery State Of Charge (SOC) or temperature. It will display a message if there is a risk of battery depletion to the point where the vehicle may stall due to lack of electrical supply, or will not restart after the current drive cycle.

When 12 Volt load reduction is activated, the message "Battery Saver On" or "Battery Saver Mode" will appear in the instrument cluster display.

These messages indicate the vehicle battery has a low state of charge and continues to lose electrical charge at a rate that the charging system cannot sustain.

### NOTE:

- The charging system is independent from load reduction. The charging system performs a diagnostic on the charging system continuously.
- If the Battery Charge Warning Light is on it may indicate a problem with the charging system  
↪ page 111.

The following are electrical loads that may be switched off (if equipped), and vehicle functions which can be affected by load reduction:

- Heated Seat/Vented Seats/Heated Wheel
- Heated/Cooled Cup Holders — If Equipped
- Rear Defroster And Heated Mirrors
- HVAC System
- 115 Volts AC Power Inverter System
- Audio and Telematics System

Loss of the battery charge may indicate one or more of the following conditions:

- The charging system cannot deliver enough electrical power to the vehicle system because the electrical loads are larger than the capability of charging system. The charging system is still functioning properly.
- Turning on all possible vehicle electrical loads (e.g. HVAC to max settings, exterior and interior lights, overloaded power outlets +12 Volts, 150W, USB ports) during certain driving conditions (city driving, towing, frequent stopping).
- Installing options like additional lights, upfitter electrical accessories, audio systems, alarms and similar devices.
- Unusual driving cycles (short trips separated by long parking periods).
- The vehicle was parked for an extended period of time (weeks, months).
- The battery was recently replaced and was not charged completely.
- The battery was discharged by an electrical load left on when the vehicle was parked.

- The battery was used for an extended period with the engine not running to supply radio, lights, chargers, +12 Volt portable appliances like vacuum cleaners, game consoles and similar devices.

### What to do when an electrical load reduction action message is present ("Battery Saver On" or "Battery Saver Mode")

During a trip:

- Reduce power to unnecessary loads if possible:
  - Turn off redundant lights (interior or exterior)
  - Check what may be plugged in to power outlets +12 Volts, 150W, USB ports
  - Check HVAC settings (blower, temperature)
  - Check the audio settings (volume)

After a trip:

- Check if any aftermarket equipment was installed (additional lights, upfitter electrical accessories, audio systems, alarms) and review specifications if any (load and Ignition Off Draw currents).
- Evaluate the latest driving cycles (distance, driving time and parking time).
- The vehicle should have service performed if the message is still present during consecutive trips and the evaluation of the vehicle and driving pattern did not help to identify the cause.



## WARNING LIGHTS AND MESSAGES

The warning/indicator lights will illuminate in the instrument panel together with a dedicated message and/or acoustic signal when applicable. These indications are indicative and precautionary and as such must not be considered as exhaustive and/or alternative to the information contained in the Owner's Manual, which you are advised to read carefully in all cases. Always refer to the information in this chapter in the event of a failure indication. All active telltales will display first if applicable. The system check menu may appear different based upon equipment options and current vehicle status. Some telltales are optional and may not appear.

### RED WARNING LIGHTS

#### Air Bag Warning Light



This warning light will illuminate to indicate a fault with the air bag, and will turn on for four to eight seconds as a bulb check when the ignition is placed in the ON/RUN or ACC/ON/RUN position. This light will illuminate with a single chime when a fault with the air bag has been detected, it will stay on until the fault is cleared. If the light is either not on during startup, stays on, or turns on while driving, have the system inspected at an authorized dealer as soon as possible.

#### Battery Charge Warning Light



This warning light will illuminate when the battery is not charging properly. If it stays on while the engine is running, there may be a malfunction with the charging system. Contact an authorized dealer as soon as possible.

This indicates a possible problem with the electrical system or a related component.

#### Brake Warning Light



This warning light monitors various brake functions, including brake fluid level and parking brake application. If the brake light turns on it may indicate that the parking brake is applied, that the brake fluid level is low, or that there is a problem with the Anti-Lock Brake System reservoir.

If the light remains on when the parking brake has been disengaged, and the fluid level is at the full mark on the master cylinder reservoir, it indicates a possible brake hydraulic system malfunction or that a problem with the Brake Booster has been detected by the Anti-Lock Brake System (ABS) / Electronic Stability Control (ESC) system. In this case, the light will remain on until the condition has been corrected. If the problem is related to the brake booster, the ABS pump will run when applying the brake, and a brake pedal pulsation may be felt during each stop.

The dual brake system provides a reserve braking capacity in the event of a failure to a portion of the hydraulic system. A leak in either half of the dual brake system is indicated by the Brake Warning Light, which will turn on when the brake fluid level in the master cylinder has dropped below a specified level.

The light will remain on until the cause is corrected.

#### NOTE:

The light may flash momentarily during sharp cornering maneuvers, which change fluid level conditions. The vehicle should have service performed, and the brake fluid level checked.

If brake failure is indicated, immediate repair is necessary.

#### WARNING!

Driving a vehicle with the red brake light on is dangerous. Part of the brake system may have failed. It will take longer to stop the vehicle. You could have a collision. Have the vehicle checked immediately.

Vehicles equipped with the Anti-Lock Brake System (ABS) are also equipped with Electronic Brake Force Distribution (EBD). In the event of an EBD failure, the Brake Warning Light will turn on along with the ABS Light. Immediate repair to the ABS system is required.

Operation of the Brake Warning Light can be checked by turning the ignition switch from the OFF position to the ON/RUN position. The light should illuminate for approximately two seconds. The light should then turn off unless the parking brake is applied or a brake fault is detected. If the light does not illuminate, have the light inspected by an authorized dealer.

The light also will turn on when the parking brake is applied with the ignition switch in the ON/RUN position.

#### NOTE:

This light shows only that the parking brake is applied. It does not show the degree of brake application.

#### Door Open Warning Light — If Equipped



This warning light will illuminate when a door is ajar/open and not fully closed. This indicator will reflect which doors are open.

#### NOTE:

If the vehicle is moving, there will also be a single chime.

## Electric Power Steering Fault Warning Light



This warning light will turn on when there's a fault with the Electric Power Steering (EPS) system → page 134.

### WARNING!

Continued operation with reduced assist could pose a safety risk to yourself and others. Service should be obtained as soon as possible.

## Electronic Throttle Control (ETC) Warning Light



This warning light will illuminate to indicate a problem with the ETC system. If a problem is detected while the vehicle is running, the light will either stay on or flash depending on the nature of the problem. Cycle the ignition when the vehicle is safely and completely stopped and the transmission is placed in the PARK (P) position. The light should turn off. If the light remains on with the vehicle running, your vehicle will usually be drivable; however, see an authorized dealer for service as soon as possible.

### NOTE:

This light may turn on if the accelerator and brake pedals are pressed at the same time.

If the light continues to flash when the vehicle is running, immediate service is required and you may experience reduced performance, an elevated/rough idle, or engine stall and your vehicle may require towing.

The light will come on when the ignition is placed in the ON/RUN or ACC/ON/RUN position and remain on briefly as a bulb check. If the light does not come on during starting, have the system checked by an authorized dealer.

## Engine Coolant Temperature Warning Light



This warning light warns of an overheated engine condition. If the engine coolant temperature is too high, this indicator will illuminate and a single chime will sound. If the temperature reaches the upper limit, a continuous chime will sound for four minutes or until the engine is able to cool; whichever comes first.

If the light turns on while driving, safely pull over and stop the vehicle. If the Air Conditioning (A/C) system is on, turn it off. Also, shift the transmission into NEUTRAL (N) and idle the vehicle. If the temperature reading does not return to normal, turn the engine off immediately and call for service → page 259.

## Hood Open Warning Light



This warning light will illuminate when the hood is left open and not fully closed.

### NOTE:

If the vehicle is moving, there will also be a single chime.

## Liftgate Open Warning Light



This warning light will illuminate when the liftgate is open.

### NOTE:

If the vehicle is moving, there will also be a single chime.

## Oil Pressure Warning Light



This warning light will illuminate to indicate low engine oil pressure. If the light turns on while driving, stop the vehicle, shut off the engine as soon as possible, and contact an authorized dealer. A chime will sound when this light turns on.

Do not operate the vehicle until the cause is corrected. This light does not indicate how much oil is in the engine. The engine oil level must be checked under the hood.

## Oil Temperature Warning Light



This warning light will illuminate to indicate the engine oil temperature is high. If the light turns on while driving, stop the vehicle and shut off the engine as soon as possible. Wait for oil temperature to return to normal levels.

## Seat Belt Reminder Warning Light



This warning light indicates when the driver or passenger seat belt is unbuckled. When the ignition is first placed in the ON/RUN or ACC/ON/RUN position and if the driver's seat belt is unbuckled, a chime will sound and the light will turn on. When driving, if the driver or front passenger seat belt remains unbuckled, the Seat Belt Reminder Light will flash or remain on continuously and a chime will sound → page 207.

## Transmission Temperature Warning Light



This warning light will illuminate to warn of a high transmission fluid temperature. This may occur with strenuous usage such as trailer towing. If this light turns on, stop the vehicle and run the engine at idle or slightly faster, with the transmission in PARK (P) or NEUTRAL (N), until the light turns off. Once the light turns off, you may continue to drive normally.

### WARNING!

If you continue operating the vehicle when the Transmission Temperature Warning Light is illuminated you could cause the fluid to boil over, come in contact with hot engine or exhaust components and cause a fire.

### CAUTION!

Continuous driving with the Transmission Temperature Warning Light illuminated will eventually cause severe transmission damage or transmission failure.

## Vehicle Security Warning Light — If Equipped



This warning light will flash at a fast rate for approximately 15 seconds when the vehicle security system is arming, and then will flash slowly until the vehicle is disarmed.

## Hybrid Electric Vehicle System Service Warning Light



This warning light will illuminate when service to the hybrid electric system is needed. It will be accompanied by a "Service Hybrid Electric Vehicle System" warning message in the cluster. If the telltale stays on or continues to come on, contact an authorized dealer as soon as possible.

## Plug Status Fault Warning Light



This warning light will illuminate when a plug status fault is detected (when vehicle not in motion). It will be accompanied by a cluster message indicating the type of fault. You may receive one of the following messages if a fault is detected:

- "Service Charging System" – If you see this message, it is recommended to unplug and plug in again, or try a different charging station. If an issue continues, contact an authorized dealer to service your high voltage charging system.
- "Issue Detected Check External Charging Station" – If you see this message, the charging station maybe powered off, having internal fault or being scheduled to charge later. It is recommended to try a different charging station. If an issue continues, then contact an authorized dealer.

### NOTE:

- Older or non-compliant J1772 EVSE models may not support charging of this vehicle. If this vehicle does not charge, it may be connected to a non-compliant Level 2 EVSE, and will flash indicators. Please identify this failure to the site operator and/or EVSE provider.
- Before this vehicle can be driven, the EVSE Charging Cord must be disconnected from the vehicle.

## Torque Limited Warning Light



This warning light illuminates when vehicle acceleration is limited due to a reduction in engine or electric motor performance. Contact an authorized dealer for service if illumination persists.

## YELLOW WARNING LIGHTS

### Anti-Lock Brake System (ABS) Warning Light



This warning light monitors the ABS. The light will turn on when the ignition is placed in the ON/RUN or ACC/ON/RUN position and may stay on for as long as four seconds.

If the ABS light remains on or turns on while driving, then the Anti-Lock portion of the brake system is not functioning and service is required as soon as possible. However, the conventional brake system will continue to operate normally, assuming the Brake Warning Light is not also on.

If the ABS light does not turn on when the ignition is placed in the ON/RUN or ACC/ON/RUN position, have the brake system inspected by an authorized dealer.

### Adaptive Cruise Control (ACC) Fault Warning Light — If Equipped



This warning light will illuminate to indicate a fault in the ACC system. Contact a local authorized dealer for service → page 138.

### Electric Park Brake Warning Light



This warning light will illuminate to indicate the Electric Park Brake is not functioning properly and service is required. Contact an authorized dealer.

### Electronic Stability Control (ESC) Active Warning Light — If Equipped



This warning light will indicate when the ESC system is Active. The ESC Indicator Light in the instrument cluster will come on when the ignition is placed in the ON/RUN or ACC/ON/RUN position, and when ESC is activated. It should go out with the engine running. If the ESC Indicator Light comes on continuously with the engine running, a malfunction has been detected in the ESC system. If this warning light remains on after several ignition cycles, and the vehicle has been driven several miles (kilometers) at speeds greater than 30 mph (48 km/h), see an authorized dealer as soon as possible to have the problem diagnosed and corrected.

- The ESC OFF Indicator Light and the ESC Indicator Light come on momentarily each time the ignition is placed in the ON/RUN or ACC/ON/RUN position.
- The ESC system will make buzzing or clicking sounds when it is active. This is normal; the sounds will stop when ESC becomes inactive.
- This light will come on when the vehicle is in an ESC event.

### Electronic Stability Control (ESC) OFF Warning Light — If Equipped



This warning light indicates the ESC is off. Each time the ignition is turned to ON/RUN or ACC/ON/RUN, the ESC system will be on, even if it was turned off previously.

### Engine Check/Malfunction Indicator Warning Light



The Engine Check/Malfunction Indicator Light (MIL) is a part of an Onboard Diagnostic System called OBD II that monitors engine and automatic transmission control systems. This warning light will illuminate when the ignition is in the ON/RUN position before engine start. If the bulb does not come on when turning the ignition switch from OFF to ON/RUN, have the condition checked promptly.

Certain conditions, such as a loose or missing gas cap, poor quality fuel, etc., may illuminate the light after engine start. The vehicle should be serviced if the light stays on through several typical driving styles. In most situations, the vehicle will drive normally and will not require towing.

When the engine is running, the MIL may flash to alert serious conditions that could lead to immediate loss of power or severe catalytic converter damage. The vehicle should be serviced by an authorized dealer as soon as possible if this occurs.

<b>WARNING!</b>
A malfunctioning catalytic converter can reach higher temperatures than in normal operating conditions. This can cause a fire if you drive slowly or park over flammable substances such as dry plants, wood, cardboard, etc. This could result in death or serious injury to the driver, occupants or others.

<b>CAUTION!</b>
Prolonged driving with the Malfunction Indicator Light (MIL) on could cause damage to the vehicle control system. It also could affect fuel economy and drivability. If the MIL is flashing, severe catalytic converter damage and power loss will soon occur. Immediate service is required.

### Fuel Level Sensor Failure Warning Light



This light illuminates when there is a fuel level sensor failure. If this light illuminates, take it to an authorized dealer and have them inspect it.

### LaneSense Warning Light — If Equipped



The LaneSense Warning Light will be solid yellow when the vehicle is approaching a lane marker. The warning light will flash when the vehicle is crossing the lane marker

→ page 152.

### Low Fuel Warning Light



When the fuel level reaches approximately 1.85 gal (7 L) this warning light will turn on, and remain on until fuel is added.

A single warning chime will sound with Low Fuel Warning.

### Low Washer Fluid Warning Light — If Equipped



This warning light will illuminate and a single chime will sound when the windshield washer fluid is low.

### Service AWD Warning Light — If Equipped



This telltale will turn on to indicate that the All Wheel Drive (AWD) system is not functioning properly and that service is required. Contact an authorized dealer.

### Service Forward Collision Warning (FCW) or Pedestrian Emergency Braking (PEB) Warning Light — If Equipped



This warning light will illuminate to indicate a fault in the FCW or PEB Warning System. Contact an authorized dealer for service  
 ⇨ page 202.

### Service LaneSense Warning Light — If Equipped



This warning light will illuminate when the LaneSense system is not operating and requires service. Please see an authorized dealer.

### Service Stop/Start System Warning Light — If Equipped



This warning light will illuminate when the Stop/Start system is not functioning properly and service is required. Contact an authorized dealer for service ⇨ page 135.

### Tire Pressure Monitoring System (TPMS) Warning Light



The warning light switches on and a message is displayed to indicate that the tire pressure is lower than the recommended value and/or that slow pressure loss is occurring. In these cases, optimal tire duration and fuel consumption may not be guaranteed.

Should one or more tires be in the condition previously mentioned, the display will show the indications corresponding to each tire.

#### CAUTION!

Do not continue driving with one or more flat tires as handling may be compromised. Stop the vehicle, avoiding sharp braking and steering. If a tire puncture occurs, repair immediately using the dedicated tire repair kit and contact an authorized dealer as soon as possible.

Each tire, including the spare (if provided), should be checked monthly when cold and inflated to the inflation pressure recommended by the vehicle manufacturer on the vehicle placard or tire inflation pressure label. If your vehicle has tires of a different size than the size indicated on the vehicle placard or tire inflation pressure label, you should determine the proper tire inflation pressure for those tires.

As an added safety feature, your vehicle has been equipped with a TPMS that illuminates a low tire pressure telltale when one or more of your tires is significantly underinflated. Accordingly, when the low tire pressure telltale illuminates, you should stop and check your tires as soon as possible, and inflate them to the proper pressure. Driving on a significantly underinflated tire causes the tire to overheat and can lead to tire failure. Underinflation also reduces fuel efficiency and tire tread life, and may affect the vehicle's handling and stopping ability.

Please note that the TPMS is not a substitute for proper tire maintenance, and it is the driver's responsibility to maintain correct tire pressure, even if underinflation has not reached the level to trigger illumination of the TPMS low tire pressure telltale.

Your vehicle has also been equipped with a TPMS malfunction indicator to indicate when the system is not operating properly. The TPMS malfunction indicator is combined with the low tire pressure telltale. When the system detects a malfunction, the telltale will flash for approximately one minute and then remain continuously illuminated. This sequence will continue upon subsequent vehicle start-ups as long as the malfunction exists. When the malfunction indicator is illuminated, the system may not be able to detect or signal low tire pressure as intended.

TPMS malfunctions may occur for a variety of reasons, including the installation of replacement or alternate tires or wheels on the vehicle that prevent the TPMS from functioning properly. Always check the TPMS malfunction telltale after replacing one or more tires or wheels on your vehicle to ensure that the replacement or alternate tires and wheels allow the TPMS to continue to function properly.

**CAUTION!**

The TPMS has been optimized for the original equipment tires and wheels. TPMS pressures and warning have been established for the tire size equipped on your vehicle. Undesirable system operation or sensor damage may result when using replacement equipment that is not of the same size, type, and/or style. Aftermarket wheels can cause sensor damage. Using aftermarket tire sealants may cause the Tire Pressure Monitoring System (TPMS) sensor to become inoperable. After using an aftermarket tire sealant it is recommended that you take your vehicle to an authorized dealer to have your sensor function checked.

**YELLOW INDICATOR LIGHTS****Forward Collision Warning (FCW) or Pedestrian Emergency Braking (PEB) OFF Indicator Light — If Equipped**

This indicator light illuminates to indicate that Forward Collision Warning (FCW) or Pedestrian Emergency Braking (PEB) is off.

**GREEN INDICATOR LIGHTS****Adaptive Cruise Control (ACC) Set With Target Vehicle Detected Indicator Light — If Equipped**

This indicator light will illuminate when the Adaptive Cruise Control speed is SET and the vehicle in front is detected → page 138.

**Adaptive Cruise Control (ACC) Set With No Target Detected Indicator Light — If Equipped**

This indicator light will illuminate when the Adaptive Cruise Control speed is SET and there is no vehicle in front detected → page 138.

**Cruise Control Set Indicator Light — If Equipped**

This indicator light will illuminate when the cruise control is set to the desired speed → page 137.

**Front Fog Indicator Light — If Equipped**

This indicator light will illuminate when the front fog lights are on.

**LaneSense Indicator Light — If Equipped**

The LaneSense indicator light illuminates solid green when both lane markings have been detected and the system is armed and ready to provide visual and torque warnings if an unintentional lane departure occurs → page 152.

**Parking/Headlights On Indicator Light**

This indicator light will illuminate when the parking lights or headlights are turned on.

**Stop/Start Active Indicator Light — If Equipped**

This indicator light will illuminate when the Stop/Start function is in "Autostop" mode → page 135.

**Turn Signal Indicator Lights**

When the left or right turn signal is activated, the turn signal indicator will flash independently and the corresponding exterior turn signal lamps will flash. Turn signals can be activated when the multifunction lever is moved down (left) or up (right).

**NOTE:**

- A continuous chime will sound if the vehicle is driven more than 1 mile (1.6 km) with either turn signal on.
- Check for an inoperative outside light bulb if either indicator flashes at a rapid rate.

## Max Regeneration Indicator Light



This indicator light will illuminate to indicate that Max Regeneration is on and capable.

When the switch is pressed, the following instrument cluster messages will be seen:

- “Max Regeneration On” – appears when the feature is turned on.
- “Max Regeneration Off” – appears when the feature is turned off.
- “Max Regeneration Unavailable” – appears when the feature is requested, but the vehicle is unable to comply. LED will flash for five seconds to indicate unavailability ↪ page 106.

## Ready To Drive Indicator Light



This indicator light will illuminate to indicate that the vehicle has enough power to be driven, regardless of the speed of the vehicle.

## Plug Status Indicator Light



When plugged in, the green plug indicator light will illuminate if the EVSE charging plug is securely attached to the charging port.

This indicates that the plug is detected, but doesn't mean it is charging. It will be accompanied with a cluster message indicating the charge status:

- “Plugged In And Charging”
- “Plugged In And Waiting to Charge On A Set Schedule”
- “Plugged in and Charging Complete”

### NOTE:

The vehicle cannot be driven until it is unplugged.

## WHITE INDICATOR LIGHTS

### Adaptive Cruise Control (ACC) Ready Light — If Equipped



This indicator light will illuminate when the vehicle equipped with ACC has been turned on but not set ↪ page 138.

### Cruise Control Ready Indicator Light



This indicator light will illuminate when the cruise control is ready, but not set ↪ page 137.

### LaneSense Indicator Light — If Equipped



When the LaneSense system is ON, but not armed, the LaneSense indicator light illuminates solid white. This occurs when only left, right, or neither lane line has been detected.

If a single lane line is detected, the system is ready to provide only visual warnings if an unintentional lane departure occurs on the detected lane line ↪ page 152.

### Set Speed Display Indicator Light



The Set Speed Display indicator light indicates the set speed for the Cruise Control and Adaptive Cruise Control (ACC) settings.

## BLUE INDICATOR LIGHTS

### High Beam Indicator Light



This indicator light will illuminate to indicate that the high beam headlights are on. With the low beams activated, push the multifunction lever forward (toward the front of the vehicle) to turn on the high beams. Pull the multifunction lever rearward (toward the rear of the vehicle) to turn off the high beams. If the high beams are off, pull the lever toward you for a temporary high beam on, “flash to pass” scenario.

3

## ONBOARD DIAGNOSTIC SYSTEM — OBD II

Your vehicle is equipped with a sophisticated Onboard Diagnostic system called OBD II. This system monitors the performance of the emissions, engine, and automatic transmission control systems. When these systems are operating properly, your vehicle will provide excellent performance and fuel economy, as well as emissions well within current government regulations.

If any of these systems require service, the OBD II system will turn on the Malfunction Indicator Light (MIL). It will also store diagnostic codes and other information to assist your service technician in making repairs. Although your vehicle will usually be drivable and not need towing, see an authorized dealer for service as soon as possible.

**CAUTION!**

- Prolonged driving with the MIL on could cause further damage to the emission control system. It could also affect fuel economy and driveability. The vehicle must be serviced before any emissions tests can be performed.
- If the MIL is flashing while the vehicle is running, severe catalytic converter damage and power loss will soon occur. Immediate service is required.

## ONBOARD DIAGNOSTIC SYSTEM (OBD II) CYBERSECURITY

Your vehicle is required to have OBD II and a connection port to allow access to information related to the performance of your emissions controls. Authorized service technicians may need to access this information to assist with the diagnosis and service of your vehicle and emissions system → page 169.

**WARNING!**

- ONLY an authorized service technician should connect equipment to the OBD II connection port in order to read the VIN, diagnose, or service your vehicle.
- If unauthorized equipment is connected to the OBD II connection port, such as a driver-behavior tracking device, it may:
  - Be possible that vehicle systems, including safety related systems, could be impaired or a loss of vehicle control could occur that may result in an accident involving serious injury or death.

(Continued)

**WARNING!**

- Access, or allow others to access, information stored in your vehicle systems, including personal information.

## EMISSIONS INSPECTION AND MAINTENANCE PROGRAMS



In some localities, it may be a legal requirement to pass an inspection of your vehicle's emissions control system. Failure to pass could prevent vehicle registration.

For states that require an Inspection and Maintenance (I/M), this check verifies the Malfunction Indicator Light (MIL) is functioning and is not on when the engine is running, and that the OBD II system is ready for testing.

Normally, the OBD II system will be ready. The OBD II system may **not** be ready if your vehicle was recently serviced, recently had a depleted battery or a battery replacement. If the OBD II system should be determined not ready for the I/M test, your vehicle may fail the test.

Your vehicle has a simple ignition actuated test, which you can use prior to going to the test station. To check if your vehicle's OBD II system is ready, you must do the following:

1. Cycle the ignition switch to the ON position, but do not crank or start the engine.

**NOTE:**

If you crank or start the engine, you will have to start this test over.

2. As soon as you cycle the ignition switch to the ON position, you will see the Malfunction Indicator Light (MIL) symbol come on as part of a normal bulb check.
3. Approximately 15 seconds later, one of two things will happen:
  - The MIL will flash for about 10 seconds and then return to being fully illuminated until you turn OFF the ignition or start the engine. This means that your vehicle's OBD II system is **not ready** and you should **not** proceed to the I/M station.
  - The MIL will not flash at all and will remain fully illuminated until you place the ignition in the off position or start the engine. This means that your vehicle's OBD II system is **ready** and you can proceed to the I/M station.

If your OBD II system is **not ready**, you should see an authorized dealer or repair facility. If your vehicle was recently serviced or had a battery failure or replacement, you may need to do nothing more than drive your vehicle as you normally would in order for your OBD II system to update. A recheck with the previously mentioned test routine may then indicate that the system is **now ready**.

Regardless of whether your vehicle's OBD II system is ready or not, if the MIL is illuminated during normal vehicle operation you should have your vehicle serviced before going to the I/M station. The I/M station can fail your vehicle because the MIL is on with the engine running.



# STARTING AND OPERATING

## STARTING THE ENGINE

Before starting your vehicle, adjust your seat, adjust both inside and outside mirrors, and fasten your seat belts.

### WARNING!

- When exiting the vehicle, always remove the key fob from the vehicle and lock your vehicle.
- Never leave children alone in a vehicle, or with access to an unlocked vehicle.
- Allowing children to be in a vehicle unattended is dangerous for a number of reasons. A child or others could be seriously or fatally injured. Children should be warned not to touch the parking brake, brake pedal or the transmission gear selector.
- Do not leave the key fob in or near the vehicle, or in a location accessible to children, and do not leave the ignition of a vehicle equipped with Keyless Enter 'n Go™ in the ACC or ON/RUN position. A child could operate power windows, other controls, or move the vehicle.
- Do not leave children or animals inside parked vehicles in hot weather. Interior heat buildup may cause serious injury or death.

Start the engine with the gear selector in the NEUTRAL (N) or PARK (P) position. Apply the brake before shifting to any driving range.

## NORMAL STARTING

### To Turn On The Engine Using the ENGINE START/STOP Button

1. The transmission must be in PARK or NEUTRAL.
2. Press and hold the brake pedal while pushing the ENGINE START/STOP button once.
3. The system starts the vehicle. If the vehicle fails to start, the starter will disengage automatically after 10 seconds.
4. If you wish to stop the cranking of the engine prior to the engine starting, push the button again.

### ENGINE START/STOP Button Functions — With Driver's Foot Off The Brake Pedal (In PARK Or NEUTRAL Position)

The ENGINE START/STOP button operates similar to an ignition switch. It has three positions; OFF, ACC, and ON/RUN. To change the ignition positions without starting the vehicle and to use the accessories, follow these steps:

- Start with the ignition in the OFF position.
- Push the ENGINE START/STOP button once to place the ignition to the ACC position (instrument cluster will display "ACC").
- Push the ENGINE START/STOP button a second time to place the ignition to the ON/RUN position (instrument cluster will display "ON/RUN").
- Push the ENGINE START/STOP button a third time to return the ignition to the OFF position (instrument cluster will display "OFF").

### NOTE:

Only press one pedal at a time while driving the vehicle. Torque performance of the vehicle could be reduced if both pedals are pressed at the same time. If pressure is detected on both pedals simultaneously, a warning message will display in the instrument cluster  
 ➔ page 103.

## AUTOPARK

AutoPark is a supplemental feature to assist with placing the vehicle in PARK under certain situations. It is a back-up system and should not be relied upon as the primary method by which the driver shifts the vehicle into PARK.

The conditions under which AutoPark will engage are outlined on the following pages.

### WARNING!

- Driver inattention could lead to failure to place the vehicle in PARK. ALWAYS DO A VISUAL CHECK that your vehicle is in PARK by verifying that a solid (not blinking) "P" is indicated in the instrument cluster display and near the gear selector. If the "P" indicator is blinking, your vehicle is not in PARK. As an added precaution, always apply the parking brake when exiting the vehicle.
- AutoPark is a supplemental feature. It is not designed to replace the need to shift your vehicle into PARK. It is a back-up system and should not be relied upon as the primary method by which the driver shifts the vehicle into PARK.

**ALWAYS DO A VISUAL CHECK** that your vehicle is in PARK by looking for the “P” in the instrument cluster display and on the gear selector. As an added precaution, always apply the parking brake.

**If the vehicle is not in PARK and the driver attempts to turn off the engine, if certain conditions are met, the vehicle will AutoPark, automatically shifting the vehicle’s transmission to the PARK position. The gear selector will automatically reset itself to the PARK position. The vehicle’s ignition will then move to the OFF position (engine off). When AutoPark is activated the instrument cluster will display the message “AutoPark Engaged”.**

AutoPark will engage when all of these conditions are met:

- Vehicle is equipped with a gear selector
- Vehicle is not in PARK
- Vehicle speed is 1.2 mph (1.9 km/h) or less
- Driver has pushed the ENGINE START/STOP button

**If the vehicle is not in PARK and the driver exits the vehicle with the engine running, if certain conditions are met, the vehicle will AutoPark, automatically shifting the vehicle’s transmission to the PARK position. The Electric Park Brake SAFE HOLD feature will also activate in some conditions** ↪ page 127.

**CAUTION!**

Engine will remain running.

AutoPark will engage when all of these conditions are met:

- Vehicle is equipped with a gear selector
- Vehicle is not in PARK
- Vehicle speed is 1.2 mph (1.9 km/h) or less

- Driver’s door is ajar
- Driver’s seat belt is unbuckled
- Brake pedal is not pressed

The message “ **AutoPark Engaged**” will display in the instrument cluster.

**AutoPark In Stop/Start Autostop Mode**

AutoPark will engage when all of these conditions are met:

- Vehicle is equipped with a gear selector
- Vehicle is not in PARK
- Vehicle speed is 1.2 mph (1.9 km/h) or less
- Driver’s door is ajar
- Driver’s seat belt is unbuckled or brake pedal is not pressed

The message “ **AutoPark Engaged**” will display in the instrument cluster.

**WARNING!**

- Never use the PARK position as a substitute for the parking brake. Always apply the parking brake fully when exiting the vehicle to guard against vehicle movement and possible injury or damage.
- Your vehicle could move and injure you and others if it is not in PARK. Check by trying to move the transmission gear selector out of PARK with the brake pedal released. Make sure the transmission is in PARK before exiting the vehicle.
- The transmission may not engage PARK if the vehicle is moving. Always bring the vehicle to a complete stop before shifting to PARK, and verify that the transmission gear position indicator solidly indicates PARK (P) without blinking.

(Continued)

**WARNING!**

Ensure that the vehicle is completely stopped, and the PARK position is properly indicated, before exiting the vehicle.

- It is dangerous to shift out of PARK or NEUTRAL if the engine speed is higher than idle speed. If your foot is not firmly pressing the brake pedal, the vehicle could accelerate quickly forward or in reverse. You could lose control of the vehicle and hit someone or something. Only shift into gear when the engine is idling normally and your foot is firmly pressing the brake pedal.
- Unintended movement of a vehicle could injure those in or near the vehicle. As with all vehicles, you should never exit a vehicle while the engine is running. Before exiting a vehicle, always come to a complete stop, then apply the parking brake, shift the transmission into PARK, and turn the ignition OFF. When the ignition is in the OFF position, the transmission is locked in PARK, securing the vehicle against unwanted movement.
- When exiting the vehicle, always make sure the ignition is in the OFF position, remove the key fob from the vehicle, and lock the vehicle.
- Never leave children alone in a vehicle, or with access to an unlocked vehicle. Allowing children to be in a vehicle unattended is dangerous for a number of reasons. A child or others could be seriously or fatally injured. Children should be warned not to touch the parking brake, brake pedal or the transmission gear selector.

(Continued)

**WARNING!**

- Do not leave the key fob in or near the vehicle (or in a location accessible to children), and do not leave the ignition in the ACC or ON/RUN position. A child could operate power windows, other controls, or move the vehicle.

**CAUTION!**

Damage to the transmission may occur if the following precautions are not observed:

- Shift into or out of PARK or REVERSE only after the vehicle has come to a complete stop.
- Do not shift between PARK, REVERSE, NEUTRAL, or DRIVE when the engine is above idle speed.
- Before shifting into any gear, make sure your foot is firmly pressing the brake pedal.

**To Turn On The Engine Using ENGINE START/STOP Button**

- The transmission must be in PARK or NEUTRAL.
- Press and hold the brake pedal while pushing the ENGINE START/STOP button once.

To release the parking brake manually, the ignition switch must be in the ON/RUN position. Press on the brake pedal, then push the parking brake switch momentarily.

**If the driver shifts into PARK while moving, the vehicle may Park.**

PARK will engage **ONLY** when vehicle speed is 1.2 mph (1.9 km/h) or less.

The message "Vehicle Speed Is Too High To Shift To P" will display in the instrument cluster display if vehicle speed is above 1.2 mph (1.9 km/h).

The gear position indicator will blink continuously until the gear selector is returned to the proper position, or the requested shift can be completed.

**WARNING!**

If vehicle speed is not below 1.2 mph (1.9 km/h) when the driver shifts into PARK, the transmission will default to NEUTRAL until the vehicle speed drops below 1.2 mph (1.9 km/h) and the conditions are met, enabling AutoPark. A vehicle left in the NEUTRAL position can roll. As an added precaution, always apply the parking brake when exiting the vehicle.

**EXTENDED PARK STARTING****NOTE:**

Extended Park condition occurs when the vehicle has not been started or driven for at least 30 days.

- Install a battery charger or jumper cables to the battery to ensure a full battery charge during the crank cycle.
- Place the ignition to the START position and release it when the engine starts. For Keyless Enter 'n Go™ ignition systems, press and hold the brake pedal while pushing the ENGINE START/STOP button once.
- If the engine fails to start within 10 seconds, wait 10 to 15 seconds to allow the starter to cool, then repeat the Extended Park Starting procedure.
- If the engine fails to start after eight attempts, allow the starter to cool for at least 10 minutes, then repeat the Extended Park Starting procedure.

**CAUTION!**

To prevent damage to the starter, do not crank continuously for more than 10 seconds at a time. Wait 10 to 15 seconds before trying again.

**IF ENGINE FAILS TO START**

If the engine fails to start after you have followed the "Normal Starting" procedure and the vehicle has not experienced an Extended Park condition as previously defined, it may be flooded. Push the accelerator pedal all the way to the floor and hold it there while the engine is cranking. This should clear any excess fuel in case the engine is flooded.

The starter motor will engage automatically, run for 10 seconds, and then disengage. Once this occurs, release the accelerator pedal and the brake pedal, wait 10 to 15 seconds, then repeat the "Normal Starting" procedure

**WARNING!**

- Never pour fuel or other flammable liquid into the throttle body air inlet opening in an attempt to start the vehicle. This could result in flash fire causing serious personal injury.
- Do not attempt to push or tow your vehicle to get it started. Vehicles equipped with an automatic transmission cannot be started this way. Unburned fuel could enter the catalytic converter and once the engine has started, ignite and damage the converter and vehicle.

(Continued)

**WARNING!**

- If the vehicle has a discharged battery, booster cables may be used to obtain a start from a booster battery or the battery in another vehicle. This type of start can be dangerous if done improperly → page 254.

## COLD WEATHER OPERATION (BELOW $-22^{\circ}\text{F}$ OR $-30^{\circ}\text{C}$ )

To ensure reliable starting at these temperatures, use of an externally powered electric engine block heater (available from an authorized dealer) is recommended.

## AFTER STARTING — WARMING UP THE ENGINE

The idle speed is controlled automatically and it will decrease as the engine warms up.

## TO TURN OFF THE ENGINE USING THE ENGINE START/STOP BUTTON

1. Place the gear selector in PARK, then push and release the ENGINE START/STOP button.
2. The ignition switch will return to the OFF position.
3. If the gear selector is not in PARK, the ENGINE START/STOP button must be held for two seconds or three short pushes in a row with the vehicle speed above 5 mph (8 km/h) before the engine will shut off. The ignition switch position will remain in the ACC position until the gear selector is in PARK and the button is pushed twice to the OFF position.

If the gear selector is not in PARK and the ENGINE START/STOP button is pushed once, the instrument cluster will display a “Vehicle Not In Park” message and the engine will remain running. Never leave a vehicle out of the PARK position, or it could roll.

**NOTE:**

If the ignition switch is left in the ACC or ON/RUN (engine not running) position and the transmission is in PARK, the system will automatically time out after 30 minutes of inactivity and the ignition will switch to the OFF position.

## STARTING THE VEHICLE — HYBRID

Before starting your vehicle, adjust your seat, adjust both inside and outside mirrors, and fasten your seat belts.

**WARNING!**

- When exiting the vehicle, always remove the key fob from the vehicle and lock your vehicle.
- Never leave children alone in a vehicle, or with access to an unlocked vehicle.
- Allowing children to be in a vehicle unattended is dangerous for a number of reasons. A child or others could be seriously or fatally injured. Children should be warned not to touch the parking brake, brake pedal or the transmission gear selector.
- Do not leave the key fob in or near the vehicle, or in a location accessible to children, and do not leave the ignition of a vehicle equipped with Keyless Enter 'n Go™ in the ACC or ON/RUN position. A child could operate power windows, other controls, or move the vehicle.

(Continued)

**WARNING!**

- Do not leave children or animals inside parked vehicles in hot weather. Interior heat buildup may cause serious injury or death.

To achieve Propulsion System Active (PSA) or Ready to Drive mode, press the brake pedal while pushing the ENGINE START/STOP button.

In extreme temperatures, high or low, the high voltage battery may need to be conditioned, and therefore may require the vehicle to be plugged in → page 14.

**NOTE:**

In case the ignition switch does not change with the push of a button, the key fob may have a low or depleted battery. In this situation, a back-up method can be used to operate the ignition switch. Put the nose side of the key fob (side opposite of the Emergency Key) against the ENGINE START/STOP button and push to operate the ignition switch.

## NORMAL STARTING

**NOTE:**

Normal starting of either a cold or a warm engine is obtained without pumping or pressing the accelerator pedal.

### Achieving Vehicle READY Using The ENGINE START/STOP Button

1. The transmission must be in PARK or NEUTRAL.
2. Press and hold the brake pedal while pushing the ENGINE START/STOP button once.

- The READY indicator will appear in the cluster when the vehicle is in Ready to Drive mode, which may include the start of the engine depending on conditions such as battery state of charge and engine temperature.
- If you wish to terminate Ready to Drive mode, push the button again.

#### ENGINE START/STOP Button Functions – With Driver's Foot Off The Brake Pedal (In PARK Or NEUTRAL Position)

The ENGINE START/STOP button operates similar to an ignition switch by providing three positions: OFF, ACC and RUN. To change the ignition mode without starting the vehicle (to power certain accessories), follow these steps:

- Start with the ignition in the OFF position.
- Push the ENGINE START/STOP button once, without brake pedal being pressed, to place the ignition in the ACC position (instrument cluster will display "ACC").
- Push the ENGINE START/STOP button a second time, without brake pedal being pressed, to place the ignition in the RUN position (instrument cluster will display "Ignition or Accessory On").

#### NOTE:

- The vehicle is not able to be driven in the Ignition or Accessory On position, see "Achieving Vehicle READY Using The ENGINE START/STOP Button" previously defined in this section for further information.
- The rotary gear selector will turn but only PARK and NEUTRAL are accessible in the Ignition or Accessory On position.

- Push the ENGINE START/STOP button a third time, without brake pedal being pressed, to return the ignition to the OFF position (instrument cluster will display "OFF").

#### NOTE:

Only press one pedal at a time while driving the vehicle. Torque performance of the vehicle could be reduced if both pedals are pressed at the same time. If pressure is detected on both pedals simultaneously, a warning message will display in the instrument cluster.

## AUTOPARK

AutoPark is a supplemental feature to assist with placing the vehicle in PARK should the situations on the following pages occur. It is a back-up system and should not be relied upon as the primary method by which the driver shifts the vehicle into PARK.

The conditions under which AutoPark will engage are outlined on the following pages.

#### WARNING!

- Driver inattention could lead to failure to place the vehicle in PARK. ALWAYS DO A VISUAL CHECK that your vehicle is in PARK by verifying that a solid (not blinking) "P" is indicated in the instrument cluster display and near the gear selector. If the "P" indicator is blinking, your vehicle is not in PARK. As an added precaution, always apply the parking brake when exiting the vehicle.
- AutoPark is a supplemental feature. It is not designed to replace the need to shift your vehicle into PARK. It is a back-up system and should not be relied upon as the primary method by which the driver shifts the vehicle into PARK.

#### ALWAYS DO A VISUAL CHECK

that your vehicle is in PARK by looking for the "P" in the instrument cluster display and on the gear selector. As an added precaution, always apply the parking brake.

If the vehicle is not in PARK and the driver attempts to turn off the engine, if certain conditions are met, the vehicle will AutoPark, automatically shifting the vehicle's transmission to the PARK position. The rotary shifter will automatically reset itself to the PARK position. The vehicle's ignition will then move to the OFF position (Engine off). When AutoPark is activated the instrument cluster will display the message "AutoPark Engaged".

AutoPark will engage when all of these conditions are met:

- Vehicle is equipped with a gear selector
- Vehicle is not in PARK
- Vehicle speed is 1.2 mph (1.9 km/h) or less
- Driver has pushed the ENGINE START/STOP button

If the vehicle is not in PARK and the driver exits the vehicle with the engine running, if certain conditions are met, the vehicle will AutoPark, automatically shifting the vehicle's transmission to the PARK position. The Electric Park Brake SAFE HOLD feature will also activate in some conditions.

#### CAUTION!

Engine will remain running.

AutoPark will engage when all of these conditions are met:

- Vehicle is equipped with a gear selector
- Vehicle is not in PARK
- Vehicle speed is 1.2 mph (1.9 km/h) or less
- Driver's door is ajar
- Driver's seat belt is unbuckled
- Brake pedal is not pressed

The message "AutoPark Engaged" will display in the instrument cluster.

#### AutoPark In Stop/Start Autostop Mode

AutoPark will engage when all of these conditions are met:

- Vehicle is equipped with a gear selector
- Vehicle is not in PARK
- Vehicle speed is 1.2 mph (1.9 km/h) or less
- Driver's door is ajar
- Driver's seat belt is unbuckled or brake pedal is not pressed

The message "AutoPark Engaged" will display in the instrument cluster.

#### WARNING!

- Never use the PARK (P) position as a substitute for the parking brake. Always apply the parking brake fully when exiting the vehicle to guard against vehicle movement and possible injury or damage.
- Your vehicle could move and injure you and others if it is not in PARK. Check by trying to move the transmission gear selector out of PARK with the brake pedal released. Make sure the transmission is in PARK before exiting the vehicle.

(Continued)

#### WARNING!

- The transmission may not engage PARK if the vehicle is moving. Always bring the vehicle to a complete stop before shifting to PARK, and verify that the transmission gear position indicator solidly indicates PARK without blinking. Ensure that the vehicle is completely stopped, and the PARK position is properly indicated, before exiting the vehicle.
- It is dangerous to shift out of PARK or NEUTRAL if your foot is not firmly pressing the brake pedal. The vehicle could accelerate quickly forward or in reverse. You could lose control of the vehicle and hit someone or something. Only shift into gear when your foot is firmly pressing the brake pedal.
- Unintended movement of a vehicle could injure those in or near the vehicle. As with all vehicles, you should never exit a vehicle while the engine is running or the propulsion system is active. Before exiting a vehicle, always come to a complete stop, then apply the parking brake, shift the transmission into PARK, and turn the ignition OFF. When the ignition is in the OFF position, the transmission is locked in PARK, securing the vehicle against unwanted movement.
- When leaving the vehicle, always make sure the ignition is in the OFF position, remove the key fob from the vehicle, and lock the vehicle.
- Never leave children alone in a vehicle, or with access to an unlocked vehicle. Allowing children to be in a vehicle unattended is dangerous for a number of reasons. A child or others could be seriously or fatally injured. Children should be warned not to touch the parking brake, brake pedal or the transmission gear selector.

(Continued)

#### WARNING!

- Do not leave the key fob in or near the vehicle (or in a location accessible to children), and do not leave the ignition in the ACC or ON/RUN position. A child could operate power windows, other controls, or move the vehicle.

#### CAUTION!

Damage to the transmission may occur if the following precautions are not observed:

- Shift into PARK or into or out of REVERSE only after the vehicle has come to a complete stop.
- Before shifting into any gear, make sure your foot is firmly pressing the brake pedal with the exception of shifting between DRIVE and LOW. Shifting between DRIVE and LOW can occur without any brake application.

#### Achieving Propulsion System Active (PSA) Using ENGINE START/STOP Button

1. The transmission must be in PARK or NEUTRAL.
2. Press and hold the brake pedal while pushing the ENGINE START/STOP button once.

To release the parking brake manually, the ignition switch must be in the ON/RUN position. Press on the brake pedal, then push the parking brake switch momentarily.

If the driver shifts into PARK while moving, the vehicle may park.

Park will engage **ONLY** when vehicle speed is 1.2 mph (1.9 km/h) or less.

The message “ **Vehicle Speed is Too High to Shift to P** ” will display in the instrument cluster display if vehicle speed is above 1.2 mph (1.9 km/h). The gear position indicator will blink continuously until the selector is returned to the proper position, or the requested shift can be completed.

#### WARNING!

If vehicle speed is not below 1.2 mph (1.9 km/h) when the driver shifts into PARK, the transmission will default to NEUTRAL until the vehicle speed drops below 1.2 mph (1.9 km/h) and the previously stated condition is met, enabling AutoPark. A vehicle left in the NEUTRAL position can roll. As an added precaution, always apply the parking brake when exiting the vehicle.

## AFTER STARTING

To optimize energy efficiency, the vehicle will automatically control engine operation.

## TO TURN OFF THE VEHICLE USING ENGINE START/STOP BUTTON

- Place the gear selector in PARK, then push and release the ENGINE START/STOP button.
- The ignition button indicator will return to the OFF position.
- If the gear selector is not in PARK, with vehicle speed less than 5 mph (8 km/h), when the ENGINE START/STOP button is pushed, the instrument cluster display will display a “Vehicle Not In Park” message, and the vehicle will remain running.
- If the gear selector is not in PARK, with vehicle speed greater than 5 mph (8 km/h), when the ENGINE START/STOP button is pushed continuously for at least two seconds (or three short pushes in a row) the vehicle ignition mode will exit Drive Ready mode and enter Accessory mode. Never leave a vehicle out of the PARK position, or it could roll.

#### NOTE:

- This vehicle is equipped with an automatic shutdown feature. If the vehicle is left in a READY state (vehicle running) with the gear selector in PARK for one hour, the vehicle will automatically turn itself off.
- The vehicle provides automatic notification, using a three Horn Chirp Alert, cluster chiming, and a cluster message “Key Fob Has Left The Vehicle” if the vehicle was not turned OFF (still “Ready to Drive”) and a valid key fob for the vehicle is not detected within the passenger cabin, following the opening and closing of any passenger compartment door (requires all doors to be closed before the key fob check will occur). These automatic alerts are to remind the driver to turn off the vehicle before leaving it, as well as, to let the driver know that the vehicle's key fob may have been unintentionally removed from the vehicle by an exiting passenger. After providing the Horn Chirp Alert, additional auto chirps will be inhibited until the gear selector has been moved out of park or ignition cycled.

## ENGINE BLOCK HEATER — IF EQUIPPED

The engine block heater warms the engine and permits quicker starts in cold weather.

Connect the cord to a 110-115 Volt AC electrical outlet with a grounded, three-wire extension cord.

For ambient temperatures below 0°F (-18°C), the engine block heater is recommended. For ambient temperatures below -20°F (-29°C), the engine block heater is required.

The engine block heater cord is routed under the hood, behind to the passenger's side headlamp. Follow these steps to properly use the engine block heater:

- Locate the engine block heater cord (behind the passenger's side headlamp).
- Undo the hook-and-loop strap that secures the heater cord in place.
- Pull the cord to the front of the vehicle and plug it into a grounded, three-wire extension cord.
- After the vehicle is running, reattach the cord to the hook-and-loop strap and properly stow it away behind the passenger's side headlamp.

#### NOTE:

- The engine block heater cord is a factory installed option. If your vehicle is not equipped, heater cords are available from an authorized dealer.
- The engine block heater will require 110 Volt AC and 6.5 Amps to activate the heater element.
- The engine block heater must be plugged in at least one hour to have an adequate warming effect on the engine.

**WARNING!**

Remember to disconnect the engine block heater cord before driving. Damage to the 110-115 Volt electrical cord could cause electrocution.

**ENGINE BREAK-IN RECOMMENDATIONS**

A long break-in period is not required for the engine and drivetrain (transmission and axle) in your vehicle.

Drive moderately during the first 300 miles (500 km). After the initial 60 miles (100 km), speeds up to 50 or 55 mph (80 or 90 km/h) are desirable.

While cruising, brief full-throttle acceleration within the limits of local traffic laws contributes to a good break-in. Wide-open throttle acceleration in low gear can be detrimental and should be avoided.

The engine oil installed in the engine at the factory is a high-quality energy conserving type lubricant. Oil changes should be consistent with anticipated climate conditions under which vehicle operations will occur.

For the recommended viscosity and quality grades  
 ⇨ page 269.

**CAUTION!**

Never use Non-Detergent Oil or Straight Mineral Oil in the engine or damage may result.

**NOTE:**

A new engine may consume some oil during its first few thousand miles (kilometers) of operation. This should be considered a normal part of the break-in and not interpreted as a problem.

**PARKING BRAKE****ELECTRIC PARK BRAKE (EPB)**

Your vehicle is equipped with an EPB that offers simple operation, and some additional features that make the parking brake more convenient and useful.

The parking brake is primarily intended to prevent the vehicle from rolling while parked. Before leaving the vehicle, make sure that the parking brake is applied. Also, be certain to leave the transmission in PARK.

You can engage the parking brake in two ways:

- Manually, by applying the EPB switch.
- Automatically, by enabling the Auto Park Brake feature in the customer programmable features  
 ⇨ page 169.

The EPB is located in the integrated center stack.

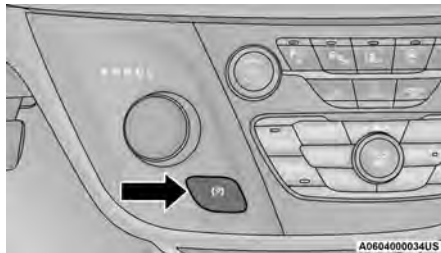

**Electric Park Brake Switch**

To apply the parking brake manually, push the switch momentarily. You may hear a sound from the back of the vehicle while the parking brake engages. Once the parking brake is fully engaged, the Brake Warning Light

in the instrument cluster and an indicator on the switch will illuminate. If your foot is on the brake pedal while you apply the parking brake, you may notice a small amount of brake pedal movement. The parking brake can be applied even when the ignition switch is OFF, however, it can only be released when the ignition switch in the ACC or ON/RUN position.

**NOTE:**

The EPB Warning Light will illuminate if the EPB switch is held for longer than 180 seconds. The light will extinguish upon releasing the switch.

If the Auto Park Brake feature is enabled, the parking brake will automatically engage whenever the transmission is placed into PARK. Once the parking brake is engaged, the Brake Warning Light in the instrument cluster and the LED indicator on the switch will illuminate. If your foot is on the brake pedal, you may notice a small amount of brake pedal movement while the parking brake is engaging.

The parking brake will release automatically when the ignition is cycled to the ON/RUN position, the transmission is in DRIVE or REVERSE, and the driver seat belt is buckled and an attempt is made to drive the vehicle away by pressing the accelerator pedal.

To release the parking brake manually, the ignition switch must be in the ON/RUN position. Press on the brake pedal, then push the parking brake switch momentarily. You may hear a sound from the back of the vehicle while the parking brake disengages. You may also notice a small amount of movement in the brake pedal. Once the parking brake is fully disengaged, the Brake Warning Light in the instrument cluster and the LED indicator on the switch will extinguish.



**NOTE:**

When parking on a hill, it is important to turn the front wheels toward the curb on a downhill grade and away from the curb on an uphill grade. Apply the parking brake before placing the gear selector in PARK, otherwise the load on the transmission locking mechanism may make it difficult to move the gear selector out of PARK. The parking brake should always be applied whenever the driver is not in the vehicle.

**WARNING!**

- Never use the PARK position as a substitute for the parking brake. Always apply the parking brake fully when parked to guard against vehicle movement and possible injury or damage.
- When exiting the vehicle, always make sure the ignition is in the OFF position, remove the key fob from the vehicle, and lock your vehicle.
- Never leave children alone in a vehicle, or with access to an unlocked vehicle. Allowing children to be in a vehicle unattended is dangerous for a number of reasons. A child or others could be seriously or fatally injured. Children should be warned not to touch the parking brake, brake pedal or the transmission gear selector.
- Do not leave the key fob in or near the vehicle, (or in a location accessible to children), and do not leave the ignition in the ACC or ON/RUN position. A child could operate power windows, other controls, or move the vehicle.
- Be sure the parking brake is fully disengaged before driving; failure to do so can lead to brake failure and a collision.

(Continued)

**WARNING!**

- Always fully apply the parking brake when leaving your vehicle, or it may roll and cause damage or injury. Also be certain to leave the transmission in PARK. Failure to do so may allow the vehicle to roll and cause damage or injury.
- Driving the vehicle with the parking brake engaged, or repeated use of the parking brake to slow the vehicle may cause serious damage to the brake system.

**CAUTION!**

If the Brake System Warning Light remains on with the parking brake released, a brake system malfunction is indicated. Have the brake system serviced by an authorized dealer immediately.

If exceptional circumstances should make it necessary to engage the parking brake while the vehicle is in motion, push on the EPB switch for as long as engagement is desired. The Brake Warning Light will illuminate, and a continuous chime will sound. The rear stop lamps will also be illuminated automatically while the vehicle remains in motion.

To disengage the parking brake while the vehicle is in motion, release the switch. If the vehicle is brought to a complete stop using the parking brake, when the vehicle reaches approximately 3 mph (4.8 km/h), the parking brake will remain engaged.

In the unlikely event of a malfunction of the EPB system, a yellow EPB Warning Light will illuminate. This may be accompanied by the Brake Warning Light flashing. In this case, urgent service of the EPB system is required. Do not rely on the parking brake to hold the vehicle stationary.

**Auto Park Brake**

The Electric Park Brake (EPB) can be programmed to be applied automatically whenever the vehicle is at a standstill and the automatic transmission is placed in PARK. Auto Park Brake is enabled and disabled by customer selection through the customer programmable features ➡ page 169.

**SafeHold**

SafeHold is a safety feature of the Electric Park Brake (EPB) system that will engage the parking brake automatically if the vehicle is left unsecured. If the automatic transmission is not in PARK, the seat belt is unbuckled, the driver door is open, the vehicle is at a standstill, and there is no attempt to press the brake pedal or accelerator pedal, the parking brake will automatically engage to prevent the vehicle from rolling.

SafeHold can be temporarily bypassed by pushing the EPB while the driver door is open and brake pedal is pressed. Once manually bypassed, SafeHold will be enabled again once the vehicle reaches 12 mph (20 km/h) or the ignition is cycled to the OFF position and back to ON again.

## Brake Service Mode

We recommend having your brakes serviced by an authorized dealer. You should only make repairs for which you have the knowledge and the right equipment. You should only enter Brake Service Mode during brake service.

When servicing your rear brakes, it may be necessary for you or your technician to push the rear piston into the rear caliper bore. With the Electric Park Brake (EPB) system, this can only be done after retracting the EPB actuator. Fortunately, actuator retraction can be done easily by entering Brake Service in your vehicle  page 169. This menu-based system will guide you through the steps necessary to retract the EPB actuator in order to perform rear brake service.

Brake Service has requirements that must be met in order to be activated:

- The vehicle must be at a standstill.
- The parking brake must be unapplied.
- The transmission must be in PARK or NEUTRAL.

While in Brake Service, the EPB Warning Light will flash continuously while the ignition switch is ON.

When brake service work is complete, the following steps must be followed to reset the parking brake system to normal operation:

- Ensure the vehicle is at a standstill.
- Press the brake pedal with moderate force.
- Apply the EPB.

### WARNING!

You can be badly injured working on or around a motor vehicle. Do only that service work for which you have the knowledge and the right equipment. If you have any doubt about your ability to perform a service job, take your vehicle to a competent mechanic.

## AUTOMATIC TRANSMISSION

You must press and hold the brake pedal while shifting out of PARK.

### WARNING!

- Never use the PARK position as a substitute for the parking brake. Always apply the parking brake fully when exiting the vehicle to guard against vehicle movement and possible injury or damage.
- Your vehicle could move and injure you and others if it is not in PARK. Check by trying to move the transmission gear selector out of PARK with the brake pedal released. Make sure the transmission is in PARK before exiting the vehicle.
- The transmission may not engage PARK if the vehicle is moving. Always bring the vehicle to a complete stop before shifting to PARK, and verify that the transmission gear position indicator solidly indicates PARK (P) without blinking. Ensure that the vehicle is completely stopped, and the PARK position is properly indicated, before exiting the vehicle.

*(Continued)*

### WARNING!

- It is dangerous to shift out of PARK or NEUTRAL if the engine speed is higher than idle speed. If your foot is not firmly pressing the brake pedal, the vehicle could accelerate quickly forward or in reverse. You could lose control of the vehicle and hit someone or something. Only shift into gear when the engine is idling normally and your foot is firmly pressing the brake pedal.
- Unintended movement of a vehicle could injure those in or near the vehicle. As with all vehicles, you should never exit a vehicle while the engine is running. Before exiting a vehicle, always come to a complete stop, then apply the parking brake, shift the transmission into PARK, and turn the ignition OFF. When the ignition is in the OFF position, the transmission is locked in PARK, securing the vehicle against unwanted movement.
- When exiting the vehicle, always make sure the ignition is in the OFF position, remove the key fob from the vehicle, and lock the vehicle.
- Never leave children alone in a vehicle, or with access to an unlocked vehicle. Allowing children to be in a vehicle unattended is dangerous for a number of reasons. A child or others could be seriously or fatally injured. Children should be warned not to touch the parking brake, brake pedal or the transmission gear selector.
- Do not leave the key fob in or near the vehicle (or in a location accessible to children), and do not leave the ignition in the ACC or ON/RUN position. A child could operate power windows, other controls, or move the vehicle.

**CAUTION!**

Damage to the transmission may occur if the following precautions are not observed:

- Shift into or out of PARK or REVERSE only after the vehicle has come to a complete stop.
- Do not shift between PARK, REVERSE, NEUTRAL, or DRIVE when the engine is above idle speed.
- Before shifting into any gear, make sure your foot is firmly pressing the brake pedal.

**IGNITION PARK INTERLOCK**

This vehicle is equipped with an Ignition Park Interlock which requires the transmission to be in PARK before the ignition can be turned to the OFF position. This helps the driver avoid inadvertently leaving the vehicle without placing the transmission in PARK. This system also locks the transmission in PARK whenever the ignition is in the OFF position.

**NOTE:**

The transmission is NOT locked in PARK when the ignition is in the ACC position (even though the engine will be off). Ensure that the transmission is in PARK, and the ignition is **OFF** (not in ACC position) before exiting the vehicle.

**BRAKE/TRANSMISSION SHIFT INTERLOCK (BTSI) SYSTEM**

This vehicle is equipped with a BTSI that holds the transmission gear selector in PARK unless the brakes are applied. To shift the transmission out of PARK, the engine must be running and the brake pedal must be pressed. The brake pedal must also be pressed to shift from NEUTRAL into DRIVE or REVERSE when the vehicle is stopped or moving at low speeds.

**9-SPEED AUTOMATIC TRANSMISSION**

The transmission is controlled using a rotary electronic gear selector located on the center console. The transmission gear selector has PARK, REVERSE, NEUTRAL, DRIVE, and LOW shift positions. Using the LOW position manually downshifts the transmission to a lower gear based on vehicle speed. The transmission gear range (PRNDL) is displayed both above the gear selector and in the instrument cluster. To select a gear range, simply rotate the gear selector. Push down on the gear selector and then rotate it, to access the L position. You must also press the brake pedal to shift the transmission out of PARK (or NEUTRAL, when stopped or moving at low speeds). To shift past multiple gear ranges at once (such as PARK to DRIVE), simply rotate the gear selector to the appropriate detent. Select the DRIVE range for normal driving.

**NOTE:**

In the event of a mismatch between the gear selector position and the actual transmission gear (for example, driver selects PARK while driving), the position indicator will blink continuously until the selector is returned to the proper position, or the requested shift can be completed.

The electronically controlled transmission adapts its shift schedule based on driver inputs, along with environmental and road conditions. The transmission electronics are self-calibrating; therefore, the first few shifts on a new vehicle may be somewhat abrupt. This is a normal condition, and precision shifts will develop within a few hundred miles (kilometers).

The 9-speed transmission has been developed to meet the needs of current and future FWD/AWD vehicles. Software and calibration is refined to optimize the customer's driving experience and fuel economy. By design, some vehicle and driveline combinations utilize NINTH gear only in very specific driving situations and conditions.

Only shift from DRIVE to PARK or REVERSE when the accelerator pedal is released and the vehicle is stopped. Be sure to keep your foot on the brake pedal when shifting between these gears.

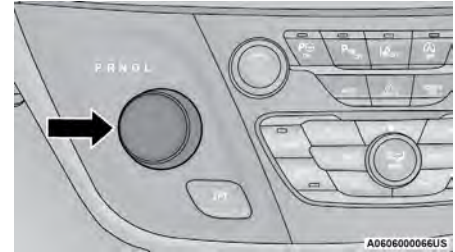
**Transmission Gear Selector****GEAR RANGES**

Do not press the accelerator pedal when shifting from PARK or NEUTRAL into another gear range.

**NOTE:**

After selecting any gear range, wait a moment to allow the selected gear to engage before accelerating. This is especially important when the engine is cold.

**PARK (P)**

This range supplements the parking brake by locking the transmission. The engine can be started in this range. Never attempt to use PARK while the vehicle is in motion. Apply the parking brake when exiting the vehicle in this range.

When parking on a hill, apply the parking brake before shifting the transmission to PARK. As an added precaution, turn the front wheels toward the curb on a downhill grade and away from the curb on an uphill grade.

When exiting the vehicle, always:

- Apply the parking brake.
- Shift the transmission into PARK.
- Turn the ignition off.
- Remove the key fob from the vehicle.

#### CAUTION!

- Before moving the transmission gear selector out of PARK, you must start the engine, and also press the brake pedal. Otherwise, damage to the gear selector could result.
- DO NOT race the engine when shifting from PARK or NEUTRAL into another gear range, as this can damage the drivetrain.

The following indicators should be used to ensure that you have properly engaged the transmission into the PARK position:

- Look at the transmission gear position display and verify that it indicates the PARK position (P), and is not blinking.
- With the brake pedal released, verify that the gear selector will not move out of PARK.

## REVERSE (R)

This range is for moving the vehicle backward. Shift into REVERSE only after the vehicle has come to a complete stop.

## NEUTRAL (N)

Use this range when the vehicle is standing for prolonged periods with the engine running. The engine may be started in this range. Apply the parking brake and shift the transmission into PARK if you must exit the vehicle.

#### WARNING!

Do not coast in NEUTRAL and never turn off the ignition to coast down a hill. These are unsafe practices that limit your response to changing traffic or road conditions. You might lose control of the vehicle and have a collision.

#### CAUTION!

Towing the vehicle, coasting, or driving for any other reason with the transmission in NEUTRAL can cause severe transmission damage.

For Recreational Towing ↪ page 167.

For Towing A Disabled Vehicle ↪ page 261.

## DRIVE (D)

This range should be used for most city and highway driving. It provides the smoothest upshifts and downshifts, and the best fuel economy. The transmission automatically upshifts through all forward gears. The DRIVE position provides optimum driving characteristics under all normal operating conditions.

If the transmission temperature exceeds normal operating limits, the transmission controller may modify the transmission shift schedule, reduce engine torque, and/or expand the range of torque converter clutch engagement. This is done to prevent transmission damage due to overheating.

If the transmission becomes extremely hot, the Transmission Temperature Warning Light will illuminate, a warning message will appear in the instrument cluster, and the transmission may operate differently until the transmission cools down.

During cold temperatures, transmission operation may be modified depending on engine and transmission temperature as well as vehicle speed. This feature improves warm-up time of the engine and transmission to achieve maximum efficiency. Engagement of the torque converter clutch, and shifts into EIGHTH or NINTH gear, are inhibited until the transmission fluid is warm ↪ page 131. Normal operation will resume once the transmission temperature has risen to a suitable level.

## LOW (L)

Use this range for engine braking when descending very steep grades. In this range, the transmission will downshift for increased engine braking. To access the LOW position, push down on the gear selector and rotate it fully clockwise.

## Transmission Limp Home Mode

Transmission function is monitored electronically for abnormal conditions. If a condition is detected that could result in transmission damage, Transmission Limp Home Mode is activated. In this mode, the transmission may operate only in a fixed gear, or may remain in NEUTRAL. The Malfunction Indicator Light (MIL) may be illuminated. Limp Home Mode may allow the vehicle to be driven to an authorized dealer for service without damaging the transmission.

In the event of a momentary problem, the transmission can be reset to regain all forward gears by performing the following steps:

1. Stop the vehicle.
2. Shift the transmission into PARK, if possible. If not, shift the transmission to NEUTRAL.
3. Push and hold the ignition switch until the engine turns off.
4. Wait approximately 30 seconds.
5. Restart the engine.
6. Shift into the desired gear range. If the problem is no longer detected, the transmission will return to normal operation.

#### NOTE:

Even if the transmission can be reset, we recommend that you visit an authorized dealer at your earliest possible convenience. An authorized dealer has diagnostic equipment to assess the condition of your transmission. If the transmission cannot be reset, authorized dealer service is required.

### Torque Converter Clutch

A feature designed to improve fuel economy has been included in the automatic transmission on your vehicle. A clutch within the torque converter engages automatically at calibrated speeds. This may result in a slightly different feeling or response during normal operation in the upper gears. When the vehicle speed drops or during some accelerations, the clutch automatically disengages.

#### NOTE:

The torque converter clutch will not engage until the engine and/or transmission is warm (usually after 1 to 3 miles [2 to 5 km] of driving). Because the engine speed is higher when the torque converter clutch is not engaged, it may seem as if the transmission is not shifting properly when the vehicle is cold. This is normal.

The torque converter clutch will function normally once the powertrain is sufficiently warm.

## AUTOMATIC TRANSMISSION — HYBRID

You must press and hold the brake pedal while shifting out of PARK.

#### WARNING!

- Never use the PARK position as a substitute for the parking brake. Always apply the parking brake fully when exiting the vehicle to guard against vehicle movement and possible injury or damage.
- Your vehicle could move and injure you and others if it is not in PARK. Check by trying to move the transmission gear selector out of PARK with the brake pedal released. Make sure the transmission is in PARK before exiting the vehicle.
- The transmission may not engage PARK if the vehicle is moving. Always bring the vehicle to a complete stop before shifting to PARK, and verify that the transmission gear position indicator solidly indicates PARK (P) without blinking. Ensure that the vehicle is completely stopped, and the PARK position is properly indicated, before exiting the vehicle.

(Continued)

#### WARNING!

- It is dangerous to shift out of PARK or NEUTRAL if the engine speed is higher than idle speed. If your foot is not firmly pressing the brake pedal, the vehicle could accelerate quickly forward or in reverse. You could lose control of the vehicle and hit someone or something. Only shift into gear when the engine is idling normally and your foot is firmly pressing the brake pedal.
- Unintended movement of a vehicle could injure those in or near the vehicle. As with all vehicles, you should never exit a vehicle while the engine is running. Before exiting a vehicle, always come to a complete stop, then apply the parking brake, shift the transmission into PARK, and turn the ignition OFF. When the ignition is in the OFF position, the transmission is locked in PARK, securing the vehicle against unwanted movement.
- When exiting the vehicle, always make sure the ignition is in the OFF position, remove the key fob from the vehicle, and lock the vehicle.
- Never leave children alone in a vehicle, or with access to an unlocked vehicle. Allowing children to be in a vehicle unattended is dangerous for a number of reasons. A child or others could be seriously or fatally injured. Children should be warned not to touch the parking brake, brake pedal or the transmission gear selector.
- Do not leave the key fob in or near the vehicle (or in a location accessible to children), and do not leave the ignition in the ACC or ON/RUN position. A child could operate power windows, other controls, or move the vehicle.

**CAUTION!**

Damage to the transmission may occur if the following precautions are not observed:

- Shift into or out of PARK or REVERSE only after the vehicle has come to a complete stop.
- Do not shift between PARK, REVERSE, NEUTRAL, or DRIVE when the engine is above idle speed.
- Before shifting into any gear, make sure your foot is firmly pressing the brake pedal.

**IGNITION PARK INTERLOCK**

This vehicle is equipped with an Ignition Park Interlock which requires the transmission to be in PARK (P) before the ignition can be turned to the OFF position. This helps the driver avoid inadvertently leaving the vehicle without placing the transmission in PARK. This system also locks the transmission in PARK whenever the ignition is in the OFF position.

**NOTE:**

The transmission will NOT shift out of the PARK position if the engine is not running even when the brakes are applied. Ensure that the transmission is in PARK, and the ignition is **OFF** (not in ACC position) before exiting the vehicle.

**BRAKE/TRANSMISSION SHIFT INTERLOCK (BTSI) SYSTEM**

Your vehicle is equipped with a BTSI system that holds the transmission gear selector in PARK unless the brakes are applied. To shift the transmission out of PARK, the ignition must be in the ON/RUN position (engine running or not) and the brake pedal must be

pressed. The brake pedal must also be pressed to shift from NEUTRAL (N) into DRIVE (D) or REVERSE (R) when the vehicle is stopped or moving at low speeds.

**HYBRID TRANSMISSION**

The transmission is controlled using a rotary electronic gear selector located on the center console. The transmission gear selector has PARK, REVERSE, NEUTRAL, DRIVE, and LOW shift positions. Using the LOW (L) position will increase the rate of deceleration along with increasing regeneration of power into the vehicle's High Voltage (HV) battery (in comparison to the DRIVE position). The transmission gear range (PRNDL) is displayed both above the gear selector and in the instrument cluster display. To select a gear range, simply rotate the gear selector. Push down on the gear selector, and then rotate it, to access the L position. You must also press the brake pedal to shift the transmission out of PARK (or NEUTRAL, when the vehicle is stopped). To shift past multiple gear ranges at once (such as PARK to DRIVE), simply rotate the gear selector to the appropriate detent. Select the DRIVE range for normal driving.

**NOTE:**

In the event of a mismatch between the gear selector position and the actual transmission gear (for example, driver selects PARK while driving), the transmission will shift into NEUTRAL and the position indicator will blink continuously until the selector is returned to the proper position, or the requested shift can be completed.

Only shift from DRIVE to PARK or REVERSE when the accelerator pedal is released and the vehicle is stopped. Be sure to keep your foot on the brake pedal when shifting between these gears.

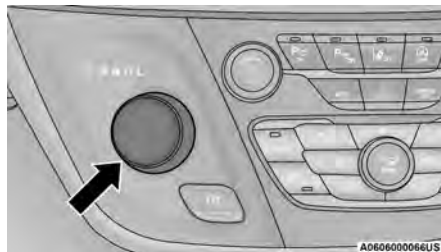
**Transmission Gear Selector****GEAR RANGES**

Do not press the accelerator pedal when shifting from PARK (P) or NEUTRAL (N) into another gear range.

**PARK (P)**

This range supplements the parking brake by locking the transmission. The vehicle propulsion system can be started in this range. Never attempt to use PARK while the vehicle is in motion. Apply the parking brake when exiting the vehicle in this range.

When parking on a hill, apply the parking brake before shifting the transmission to PARK. As an added precaution, turn the front wheels toward the curb on a downhill grade and away from the curb on an uphill grade.

When exiting the vehicle, always:

- Apply the parking brake.
- Shift the transmission into PARK.
- Turn the ignition OFF.
- Remove the key fob from the vehicle.

**NOTE:**

This vehicle incorporates an Electric Park Brake activation feature which engages automatically when the vehicle is parked on a 9% sloped surface, with the vehicle pointing up the grade or down the grade.

**CAUTION!**

- Before moving the transmission gear selector out of PARK, you must turn the ignition to the ON/RUN position, and also press the brake pedal. Otherwise, damage to the gear selector could result.
- DO NOT press the accelerator pedal when shifting from PARK or NEUTRAL into another gear range, as this can damage the drivetrain.

The following indicators should be used to ensure that you have properly engaged the transmission into the PARK position:

- Look at the transmission gear position display and verify that it indicates the PARK position (P), and is not blinking.
- With the brake pedal released, verify that the gear selector will not move out of PARK.

**REVERSE (R)**

This range is for moving the vehicle backward. Shift into REVERSE only after the vehicle has come to a complete stop.

**NOTE:**

Based on the drive gear and/or speed of the vehicle, the Vehicle Pedestrian Alert Module (VPAM) will broadcast a sound from the rear of the vehicle to warn nearby pedestrians that a vehicle is approaching. In addition, the module will indicate a change in speed by varying the volume of sound.

**NEUTRAL (N)**

Use this range when the vehicle is standing for prolonged periods with the propulsion system active. The vehicle may be started in this range. Apply the parking brake and shift the transmission into PARK if you must exit the vehicle.

**NOTE:**

Based on the drive gear and/or speed of the vehicle, the Vehicle Pedestrian Alert Module (VPAM) will broadcast a sound from the rear of the vehicle (if moving in the rearward direction) or from the front (if moving in the forward direction) or from both the front and rear if vehicle direction cannot be determined, to warn nearby pedestrians that a vehicle is approaching. In addition, the module will indicate a change in speed by varying the volume of sound.

**WARNING!**

Do not coast in NEUTRAL and never turn off the ignition to coast down a hill. These are unsafe practices that limit your response to changing traffic or road conditions. You might lose control of the vehicle and have a collision.

**CAUTION!**

Towing the vehicle, coasting, or driving for any other reason with the transmission in NEUTRAL can cause severe transmission damage.

For Recreational Towing ⇄ page 167.

For Towing A Disabled Vehicle ⇄ page 261.

**DRIVE (D)**

This range should be used for most city and highway driving. The DRIVE position provides optimum driving characteristics under all normal operating conditions.

**NOTE:**

- If the transmission becomes too hot, the Transmission Temperature Warning Light may illuminate, a warning message may appear in the instrument cluster display and the torque level may be reduced until the transmission cools down.
- Based on the drive gear and/or speed of the vehicle, the Vehicle Pedestrian Alert Module (VPAM) will broadcast a sound from the front of the vehicle to warn nearby pedestrians that a vehicle is approaching. In addition, the module will indicate a change in speed by varying the volume of sound.

**LOW (L)**

This range should be used when descending very steep grades or when increased regeneration is desired. The vehicle transmission can be operated continuously in LOW without damaging the vehicle or causing issues. Using the LOW position will increase the rate of deceleration (along with increasing regeneration of power into the vehicle's high voltage battery) when the accelerator pedal is released in comparison to the DRIVE position. To access the LOW position, push down on the gear selector and rotate it fully clockwise. Shifting between DRIVE and LOW can be done at any speed.

**NOTE:**

- Driving the vehicle in LOW will make the transitions between vehicle accelerating and coasting, as well as vehicle coasting and accelerating, more noticeable.
- Based on the drive gear and/or speed of the vehicle, the Vehicle Pedestrian Alert Module (VPAM) will broadcast a sound from the front of the vehicle to warn nearby pedestrians that a vehicle is approaching. In addition, the module will indicate a change in speed by varying the volume of sound.

**Transmission Limp Home Mode**

Transmission function is monitored electronically for abnormal conditions. If a condition is detected that could result in transmission damage, Transmission Limp Home Mode is activated. In this mode, vehicle speed is limited to about 45 mph (72 km/h). In addition to the Malfunction Indicator Light (MIL), the Service Hybrid System Telltale, the Red Turtle indication, and a pop-up message indicating that vehicle speed may be limited may all be illuminated. Limp Home Mode allows the vehicle to be driven to an authorized dealer for service without damaging the transmission.

In the event of a momentary problem, the transmission can be reset to regain functionality by performing the following steps:

1. Stop the vehicle in a safe location.
2. Place the transmission in PARK, if possible. If not, place the transmission in NEUTRAL.
3. Push and hold the ignition switch until the vehicle turns OFF.
4. Wait approximately 30 seconds.

5. Restart the vehicle.
6. Shift into the desired gear range. If the problem is no longer detected, the transmission will return to normal operation.

**NOTE:**

Even if the transmission can be reset, we recommend that you visit an authorized dealer at your earliest possible convenience. An authorized dealer has diagnostic equipment to assess the condition of your transmission. If the transmission cannot be reset, authorized dealer service is required.

**ALL-WHEEL DRIVE (AWD) —  
IF EQUIPPED**

This feature provides on-demand All-Wheel Drive (AWD). The system is automatic with no driver inputs or additional driving skills required. Under normal driving conditions, the front wheels provide most of the traction. If the front wheels begin to lose traction, power is shifted automatically to the rear wheels. The greater the front wheel traction loss, the greater the power transfer to the rear wheels.

Additionally, on dry pavement under heavy throttle input (where one may have no wheel spin), torque will be sent to the rear in a preemptive effort to improve vehicle launch and performance characteristics.

**CAUTION!**

All wheels must have the same size and type tires. Unequal tire sizes must not be used. Unequal tire size may cause premature wear of the driveline components.

**ACTIVE NOISE CANCELLATION**

Your vehicle is equipped with an Active Noise Cancellation system. This system is designed to address exhaust and engine noise. The system relies on four microphones embedded in the headliner, which monitor exhaust and engine noise, and assists an onboard frequency generator, which creates counteracting sound waves in the audio system's speakers. This helps keep the vehicle quiet at idle and during drive.

**POWER STEERING**

The electric power steering system will provide increased vehicle response and ease of maneuverability. The power steering system adapts to different driving conditions.

**WARNING!**

Continued operation with reduced assist could pose a safety risk to yourself and others. Service should be obtained as soon as possible.

If the Steering icon is displayed and the "Power Steering System Over Temp" message is displayed on the instrument cluster screen, this indicates an over temperature condition in the power steering system. Once driving conditions are safe, pull over and let the vehicle idle for a few moments until the icon and message turn off  
 ⇨ page 111.





If the “Service Power Steering” or “Power Steering Assist Off - Service System” message and a steering wheel icon are displayed on the instrument cluster screen, it indicates that the vehicle needs to be taken to an authorized dealer for service. It is likely the vehicle has lost power steering assistance → page 111.

#### NOTE:

- Even if the power steering assistance is no longer operational, it is still possible to steer the vehicle. Under these conditions there will be a substantial increase in steering effort, especially at low speeds and during parking maneuvers.
- The power steering system is fully electric; it requires no power steering fluid.
- If the condition persists, see an authorized dealer for service.

## STOP/START SYSTEM — IF EQUIPPED

The Stop/Start function is designed to reduce fuel consumption. The system will stop the engine automatically during a vehicle stop if the required conditions are met. Releasing the brake pedal, pressing the accelerator pedal or shifting out of DRIVE (D) will automatically re-start the engine.

This vehicle has been upgraded with a heavy-duty starter, enhanced battery, and other upgraded engine parts to handle the additional engine starts.

## AUTOSTOP MODE

The Stop/Start feature is enabled after every driver key start. At that time, the system will go into STOP/START READY and if all other conditions are met, can go into a STOP/START AUTOSTOP ACTIVE.

#### To Activate Auto STOP/START, The Following Must Occur:

- The system must be in STOP/START READY state. A STOP/START READY message will be displayed in the instrument cluster within the Stop/Start section → page 111.
- The vehicle must be completely stopped.
- The gear selector must be in a forward gear and the brake pedal pressed.

The engine will shut down, the tachometer will move to the zero position and the Stop/Start telltale will illuminate indicating you are in Autostop. Customer settings will be maintained throughout the Auto Stop/Start process.

## POSSIBLE REASONS THE ENGINE DOES NOT AUTOSTOP

Prior to engine shut down, the system will check many safety and comfort conditions for Stop/Start and ensure they are fulfilled. Detailed information about the operation of the Stop/Start system may be viewed in the instrument cluster display Stop/Start screen. Situations when the engine will not stop include (but not limited to):

- If Stop/Start is manually disabled by the Stop/Start OFF button.
- Driver’s seat belt is not buckled.
- Driver’s door is not closed.

- Battery temperature is too warm or cold.
- Battery charge is low. During this time a message will display “Stop/Start Not Ready Battery Charging”.
- The vehicle is on a steep grade.
- Cabin heating or cooling is in process and an acceptable cabin temperature has not been achieved.
- HVAC is set to full defrost mode at a high blower speed.
- HVAC is set to MAX A/C.
- Engine has not reached normal operating temperature.
- The transmission is not in a forward gear.
- Hood is open.
- Brake pedal is not pressed with sufficient pressure.
- Accelerator pedal input.
- Engine temperature is too high.
- 5 mph (8 km/h) threshold has not been achieved from previous Autostop.
- Steering angle is beyond threshold.
- Vehicle is at too high of an altitude.
- Ambient temperature is beyond operating range.
- Stop/Start related system malfunction.
- Adaptive Cruise Control (ACC) is on and speed is set.

It may be possible for the vehicle to be driven several times without the Stop/Start system going into a STOP/START READY state under more extreme conditions of the items listed.

## TO START THE ENGINE WHILE IN AUTOSTOP

While in a forward gear, the engine will start when the brake pedal is released or the accelerator pedal is pressed. The transmission will automatically re-engage upon engine restart.

### Conditions That Will Cause The Engine To Start Automatically While In Autostop:

- The transmission selector is moved out of DRIVE.
- To maintain cabin temperature comfort.
- HVAC is set to full defrost mode.
- HVAC system temperature or fan speed is manually adjusted.
- Battery voltage drops too low. During this time a message will display “Stop/Start Not Ready Battery Charging”.
- Stop/Start OFF switch is pushed.
- Stop/Start related system malfunction.
- Steering wheel is turned beyond threshold.

## TO MANUALLY TURN OFF THE STOP/START SYSTEM



**Stop/Start OFF Button**

Push the Stop/Start OFF switch (located on the switch bank). The light on the switch will illuminate. The “STOP/START OFF” message will appear in the instrument cluster display and the Autostop mode will be disabled ↪ page 111.

### NOTE:

The Stop/Start system will reset itself back to the ON mode every time the ignition is turned OFF and back ON.

## TO MANUALLY TURN ON THE STOP/START SYSTEM

After turning off the Stop/Start system, push the Stop/Start OFF switch again (located on the switch bank). The light on the switch will turn off.

## SYSTEM MALFUNCTION

If there is a malfunction in the Stop/Start system, the system will not shut down the engine. A “Service STOP/START System” message and a yellow Stop/Start tell-tale will appear in the instrument cluster display.

If the “Service STOP/START System” message appears in the instrument cluster display, have the system checked by an authorized dealer.

If a malfunction occurs during an autostop, the vehicle may not auto start and will need a key start.

## CRUISE CONTROL SYSTEMS — IF EQUIPPED

Your vehicle may be equipped with the Cruise Control system, or the Adaptive Cruise Control (ACC) system:

- Cruise Control will keep your vehicle at a constant preset speed.
- Adaptive Cruise Control (ACC) will adjust the vehicle speed up to the preset speed to maintain a distance with the vehicle ahead.

### NOTE:

- In vehicles equipped with ACC, if ACC is not enabled, Fixed Speed Cruise Control will not detect vehicles directly ahead of you. Always be aware of the feature selected.
- Only one Cruise Control feature can operate at a time. For example, if Fixed Speed Cruise Control is enabled, Adaptive Cruise Control will be unavailable, and vice versa.

## CRUISE CONTROL

When engaged, the Cruise Control takes over accelerator operations at speeds greater than 20 mph (32 km/h).

The Cruise Control buttons are located on the right side of the steering wheel.

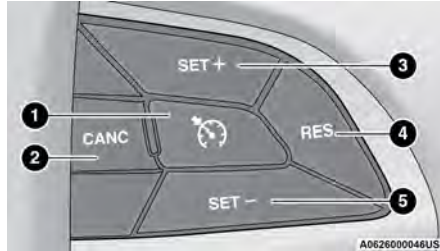

**Cruise Control Buttons**

- 1 – On/Off
- 2 – CANCEL/Cancel
- 3 – SET (+)/Accel
- 4 – RES/Resume
- 5 – SET (-)/Decel

### WARNING!

Cruise Control can be dangerous where the system cannot maintain a constant speed. Your vehicle could go too fast for the conditions, and you could lose control and have an accident. Do not use Cruise Control in heavy traffic or on roads that are winding, icy, snow-covered or slippery.

## To Activate

Push the on/off button to activate the Cruise Control. The Cruise Control Set Indicator Light in the instrument cluster display will illuminate. To turn the system off, push the on/off button a second time. The Cruise Control Set Indicator Light will turn off. The system should be turned off when not in use.

### WARNING!

Leaving the Cruise Control system on when not in use is dangerous. You could accidentally set the system or cause it to go faster than you want. You could lose control and have an accident. Always turn the system off when you are not using it.

## To Set A Desired Speed

Turn the Cruise Control on.

### NOTE:

The vehicle should be traveling at a steady speed and on level ground before pushing the SET (+) or SET (-) button.

When the vehicle has reached the desired speed, push the SET (+) or SET (-) button and release. Release the accelerator and the vehicle will operate at the selected speed.

## To Vary The Speed Setting

### To Increase Or Decrease The Set Speed

When the Cruise Control is set, you can increase speed by pushing the SET (+) button, or decrease speed by pushing the SET (-) button.

## U.S. Speed (mph)

- Pushing the SET (+), or SET (-) button once will result in a 1 mph speed adjustment. Each subsequent tap of the button results in an adjustment of 1 mph.
- If the button is continually pushed, the set speed will continue to adjust in 5 mph increments until the button is released. The new set speed is reflected in the instrument cluster display.

## Metric Speed (km/h)

- Pushing the SET (+), or SET (-) button once will result in a 1 km/h speed adjustment. Each subsequent tap of the button results in an adjustment of 1 km/h.
- If the button is continually pushed, the set speed will continue to adjust in 10 km/h increments until the button is released. The new set speed is reflected in the instrument cluster display.

## To Accelerate For Passing

While the Cruise Control is set, press the accelerator to pass as you would normally. When the pedal is released, the vehicle will return to the set speed.

## USING CRUISE CONTROL ON HILLS

The transmission may downshift on hills to maintain the vehicle set speed.

The Cruise Control system maintains speed up and down hills. A slight speed change on moderate hills is normal. On steep hills, a greater speed loss or gain may occur so it may be preferable to drive without Cruise Control.

**WARNING!**

Cruise Control can be dangerous where the system cannot maintain a constant speed. Your vehicle could go too fast for the conditions, and you could lose control and have an accident. Do not use Cruise Control in heavy traffic or on roads that are winding, icy, snow-covered or slippery.

**To Resume Speed**

To resume a previously set speed, push the RES button and release. Resume can be used at any speed above 20 mph (32 km/h).

**To Deactivate**

A tap on the brake pedal, or pushing the CANC button, or normal brake pressure will deactivate the Cruise Control system without erasing the set speed from memory.

Pushing the on/off button or placing the ignition in the OFF position erases the set speed from memory.

**ADAPTIVE CRUISE CONTROL (ACC)**

Adaptive Cruise Control (ACC) increases the driving convenience provided by cruise control while traveling on highways and major roadways. However, it is not a safety system and not designed to prevent collisions.

**The Cruise Control function performs differently**

➡ page 137.

ACC will allow you to keep Cruise Control engaged in light to moderate traffic conditions without the constant need to reset your Cruise Control. ACC utilizes a radar sensor and a forward facing camera designed to detect a vehicle directly ahead of you.

**NOTE:**

- If the ACC sensor detects a vehicle ahead, ACC will apply limited braking or accelerate (not to exceed the original set speed) automatically to maintain a preset following distance, while matching the speed of the vehicle ahead.
- Any chassis/suspension or tire size modifications to the vehicle will affect the performance of the Adaptive Cruise Control and Forward Collision Warning system.
- Fixed Speed Cruise Control will not detect vehicles directly ahead of you. Always be aware of the feature selected ➡ page 318.

**WARNING!**

- Adaptive Cruise Control (ACC) is a convenience system. It is not a substitute for active driver involvement. It is always the driver's responsibility to be attentive of road, traffic, and weather conditions, vehicle speed, distance to the vehicle ahead and, most importantly, brake operation to ensure safe operation of the vehicle under all road conditions. Your complete attention is always required while driving to maintain safe control of your vehicle. Failure to follow these warnings can result in a collision and death or serious personal injury.

*(Continued)*

**WARNING!**

- The ACC system:
  - Does not react to pedestrians, oncoming vehicles, and stationary objects (e.g., a stopped vehicle in a traffic jam or a disabled vehicle).
  - Cannot take street, traffic, and weather conditions into account, and may be limited upon adverse sight distance conditions.
  - Does not always fully recognize complex driving conditions, which can result in wrong or missing distance warnings.
  - Will bring the vehicle to a complete stop while following a target vehicle and hold the vehicle for approximately three minutes in the stop position. If the target vehicle does not start moving within three minutes the parking brake will be activated, and the ACC system will be canceled.

You should not utilize the ACC system:

- When driving in fog, heavy rain, heavy snow, sleet, heavy traffic, and complex driving situations (i.e., in highway construction zones).
- When entering a turn lane or highway off-ramp; when driving on roads that are winding, icy, snow-covered, slippery, or have steep uphill or downhill slopes.
- When towing a trailer up or down steep slopes.
- When circumstances do not allow safe driving at a constant speed.

## Adaptive Cruise Control (ACC) Operation

The buttons on the right side of the steering wheel operate the ACC system.

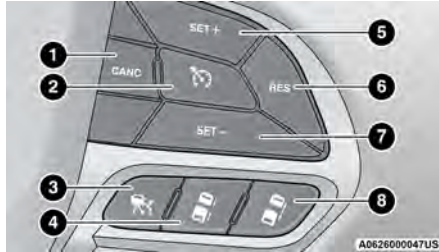

**Adaptive Cruise Control Buttons**

- 1 – CANCEL/Cancel
- 2 – Fixed Speed Cruise Control On/Off
- 3 – Adaptive Cruise Control (ACC) On/Off
- 4 – Distance Decrease
- 5 – SET (+)/Accel
- 6 – RES/Resume
- 7 – SET (-)/Decel
- 8 – Distance Increase

## Adaptive Cruise Control (ACC) Menu

The instrument cluster displays the current ACC system settings. The information it displays depends on ACC system status.

Push the Adaptive Cruise Control (ACC) on/off button until one of the following displays in the instrument cluster display:

### Adaptive Cruise Control Off

When ACC is deactivated, the display will read “Adaptive Cruise Control Off.”

### Adaptive Cruise Control Ready

When ACC is activated but the vehicle speed setting has not been selected, the display will read “Adaptive Cruise Control Ready.”

Push the SET (+) or the SET (-) button (located on the steering wheel) and the following will display in the instrument cluster display:

### Adaptive Cruise Control Set

When the SET (+) or the SET (-) button is pushed, the display will read “ACC SET.”

When ACC is set, the set speed will display in the instrument cluster.

The ACC screen may display once again if any of the following ACC activity occurs:

- System Cancel
- Driver Override
- System Off
- ACC Proximity Warning
- ACC Unavailable Warning

The instrument cluster display will return to the last display selected after five seconds of no ACC display activity.

## Activating Adaptive Cruise Control (ACC)

The minimum set speed for the ACC system is 20 mph (32 km/h).

When the system is turned on and in the READY state, the instrument cluster displays “ACC Ready.”

When the system is off, the instrument cluster display “Adaptive Cruise Control (ACC) Off.”

### NOTE:

You cannot engage ACC under the following conditions:

- When the brakes are applied
- When the parking brake is applied
- When the gear selector is in PARK, REVERSE or NEUTRAL
- When the vehicle speed is below the minimum speed range
- When the brakes are overheated
- When the driver’s door is open at low speeds
- When the driver’s seat belt is unbuckled at low speeds

## To Activate/Deactivate

Push and release the Adaptive Cruise Control (ACC) on/off button. The ACC menu in the instrument cluster will read “ACC Ready.”

To turn the system off, push and release the Adaptive Cruise Control (ACC) on/off button again. At this time, the system will turn off and the instrument cluster display will show “Adaptive Cruise Control (ACC) Off.”

**WARNING!**

Leaving the Adaptive Cruise Control (ACC) system on when not in use is dangerous. You could accidentally set the system or cause it to go faster than you want. You could lose control and have a collision. Always leave the system off when you are not using it.

**To Set A Desired Speed**

When the vehicle reaches the speed desired, push the SET (+) button or the SET (-) button and release. The instrument cluster display will show the set speed.

**NOTE:**

Fixed Speed Cruise Control can be used without ACC enabled. To change between the different modes, push the **ACC on/off button** which turns the ACC and the Fixed Speed Cruise Control off. Pushing the **Fixed Speed Cruise Control on/off button** will result in turning on (changing to) Fixed Speed Cruise Control mode.

**WARNING!**

In Fixed Speed Cruise Control mode, the system will not react to vehicles ahead. In addition, the proximity warning does not activate and no alarm will sound even if you are too close to the vehicle ahead since neither the presence of the vehicle ahead nor the vehicle-to-vehicle distance is detected. Be sure to maintain a safe distance between your vehicle and the vehicle ahead. Always be aware which mode is selected.

If ACC is set when the vehicle speed is **below** 20 mph (32 km/h), the set speed will default to 20 mph (32 km/h).

**NOTE:**

Fixed Speed Cruise Control cannot be set below 20 mph (32 km/h).

If either system is set when the vehicle speed is **above** 20 mph (32 km/h), the set speed shall be the current speed of the vehicle.

**NOTE:**

- Keeping your foot on the accelerator pedal can cause the vehicle to continue to accelerate beyond the set speed. If this occurs, the message "Driver Override" will display in the instrument cluster display.
- If you continue to accelerate beyond the set speed while an ACC is enabled, the system will not be controlling the distance between your vehicle and the vehicle ahead. The vehicle speed will only be determined by the position of the accelerator pedal.

**To Cancel**

The following conditions cancel the ACC or Fixed Speed Cruise Control systems:

- The brake pedal is applied
- The CANC (cancel) button is pushed
- The Anti-Lock Brake System (ABS) activates
- The gear selector is removed from the DRIVE position
- The Electronic Stability Control/Traction Control System (ESC/TCS) activates
- The vehicle parking brake is applied
- The braking temperature exceeds normal range (overheated)

The following conditions will only cancel the ACC system:

- Driver seat belt is unbuckled at low speeds
- Driver door is opened at low speeds

**To Turn Off**

The system will turn off and clear the set speed in memory if:

- The Adaptive Cruise Control (ACC) on/off button is pushed
- The Fixed Speed Cruise Control on/off button is pushed
- The ignition is placed in the OFF position

**To Resume**

If there is a set speed in memory, push the RES (resume) button and then remove your foot from the accelerator pedal. The instrument cluster display will display the last set speed.

Resume can be used at any speed above 20 mph (32 km/h) when only Fixed Speed Cruise Control is being used.

**NOTE:**

- If your vehicle is at a standstill longer than two seconds, the driver will either have to push the RES (resume) button, or apply the accelerator pedal to reengage the Adaptive Cruise Control (ACC) to the existing set speed.
- ACC cannot be resumed if there is a stationary vehicle in front of your vehicle in close proximity.

**WARNING!**

The Resume function should only be used if traffic and road conditions permit. Resuming a set speed that is too high or too low for prevailing traffic and road conditions could cause the vehicle to accelerate or decelerate too sharply for safe operation. Failure to follow these warnings can result in a collision and death or serious personal injury.

**To Vary The Speed Setting****To Increase Or Decrease The Set Speed**

After setting a speed, you can increase the set speed by pushing the SET (+) button, or decrease speed by pushing the SET (-) button.

**U.S. Speed (mph)**

- Pushing the SET (+), or SET (-) button once will result in a 1 mph speed adjustment. Each subsequent tap of the button results in an adjustment of 1 mph.
- If the button is continually pushed, the set speed will continue to adjust in 5 mph increments until the button is released. The new set speed is reflected in the instrument cluster display.

**Metric Speed (km/h)**

- Pushing the SET (+), or SET (-) button once will result in a 1 km/h speed adjustment. Each subsequent tap of the button results in an adjustment of 1 km/h.
- If the button is continually pushed, the set speed will continue to adjust in 10 km/h increments until the button is released. The new set speed is reflected in the instrument cluster display.

**NOTE:**

When you override and push the SET (+) button or SET (-) buttons, the new set speed will be the current speed of the vehicle.

**When ACC Is Active**

- When you use the SET (-) button to decelerate, if the engine's braking power does not slow the vehicle sufficiently to reach the set speed, the brake system will automatically slow the vehicle.
- The ACC system decelerates the vehicle to a full stop when following the vehicle in front. If your vehicle follows the vehicle in front to a standstill, after two seconds the driver will either have to push the RES (resume) button, or apply the accelerator pedal to reengage the ACC to the existing set speed.
- The ACC system maintains set speed when driving uphill and downhill. However, a slight speed change on moderate hills is normal. In addition, downshifting may occur while climbing uphill or descending downhill. This is normal operation and necessary to maintain set speed. When driving uphill and downhill, the ACC system will cancel if the braking temperature exceeds normal range (overheated).

**Setting The Following Distance In ACC**

The specified following distance for ACC can be set by varying the distance setting between four bars (longest), three bars (long), two bars (medium) and one bar (short). Using this distance setting and the vehicle speed, ACC calculates and sets the distance to the vehicle ahead. This distance setting displays in the instrument cluster display.

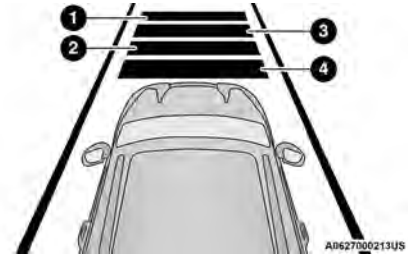
**Distance Settings**

- 1 — Longest Distance Setting (Four Bars)
- 2 — Medium Distance Setting (Two Bars)
- 3 — Long Distance Setting (Three Bars)
- 4 — Short Distance Setting (One Bar)

To increase the distance setting, push the Distance Increase button and release. Each time the button is pushed, the distance setting increases by one bar (longer).

To decrease the distance setting, push the Distance Decrease button and release. Each time the button is pushed, the distance setting decreases by one bar (shorter).

If there is no vehicle ahead, the vehicle will maintain the set speed. If a slower moving vehicle is detected in the same lane, the instrument cluster displays the ACC Set With Target Detected Indicator Light, and the system adjusts vehicle speed automatically to maintain the distance setting, regardless of the set speed.

The vehicle will then maintain the set distance until:

- The vehicle ahead accelerates to a speed above the set speed.
- The vehicle ahead moves out of your lane or view of the sensor.
- The distance setting is changed.
- The system disengages → page 139.

The maximum braking applied by ACC is limited; however, the driver can always apply the brakes manually, if necessary.

#### NOTE:

The brake lights will illuminate whenever the ACC system applies the brakes.

A Proximity Warning will alert the driver if ACC predicts that its maximum braking level is not sufficient to maintain the set distance. If this occurs, a visual alert “BRAKE!” will flash in the instrument cluster display and a chime will sound while ACC continues to apply its maximum braking capacity.

#### NOTE:

The “BRAKE!” screen in the instrument cluster display is a warning for the driver to take action and does not necessarily mean that the Forward Collision Warning system is applying the brakes autonomously.

## Overtake Aid

When driving with Adaptive Cruise Control (ACC) engaged and following a vehicle, the system will provide an additional acceleration up to the ACC set speed to assist in passing the vehicle. This additional acceleration is triggered when the driver utilizes the left turn signal and will only be active when passing on the left hand side.

## ACC Operation At Stop

In the event that the ACC system brings your vehicle to a standstill while following the vehicle in front, your vehicle will resume motion, without the need for any driver action, if the vehicle in front starts moving within two seconds.

If the vehicle in front does not start moving within two seconds of your vehicle coming to a standstill, the driver will either have to push the RES (resume) button, or apply the accelerator pedal to reengage the ACC to the existing set speed.

#### NOTE:

After the ACC system holds your vehicle at a standstill for approximately three consecutive minutes, the parking brake will be activated, and the ACC system will be canceled.

While the ACC system is holding your vehicle at a standstill, if the driver seat belt is unbuckled or the driver door is opened, the parking brake will be activated, and the ACC system will be canceled.

#### WARNING!

When the ACC system is resumed, the driver must ensure that there are no pedestrians, vehicles or objects in the path of the vehicle. Failure to follow these warnings can result in a collision and death or serious personal injury.

## Display Warnings And Maintenance

### “WIPE FRONT RADAR SENSOR” WARNING

The “ACC/AEB Unavailable Wipe Front Radar Sensor” warning will display and a chime will sound when conditions temporarily limit system performance.

This most often occurs at times of poor visibility, such as in snow or heavy rain. The ACC system may also become temporarily blinded due to obstructions, such as mud, dirt or ice. In these cases, the instrument cluster display will show “ACC/AEB Unavailable Wipe Front Radar Sensor” and the system will deactivate.

The “ACC/AEB Unavailable Wipe Front Radar Sensor” message can sometimes be displayed while driving in highly reflective areas (i.e. ice and snow, or tunnels with reflective tiles). The ACC system will recover after the vehicle has left these areas. Under rare conditions, when the radar is not tracking any vehicles or objects in its path this warning may temporarily occur.

#### NOTE:

If the “ACC/AEB Unavailable Wipe Front Radar Sensor” warning is active, Fixed Speed Cruise Control is still available.

If weather conditions are not a factor, the driver should examine the sensor. It may require cleaning or removal of an obstruction. The sensor is located in the center of the vehicle behind the lower grille.

To keep the ACC System operating properly, it is important to note the following maintenance items:

- Always keep the sensor clean. Carefully wipe the sensor lens with a soft cloth. Be cautious not to damage the sensor lens.



- Do not remove any screws from the sensor. Doing so could cause an ACC system malfunction or failure and require a sensor realignment.
- If the sensor or front end of the vehicle is damaged due to a collision, see an authorized dealer for service.
- Do not attach or install any accessories near the sensor, including transparent material or aftermarket grilles. Doing so could cause an ACC system failure or malfunction.

When the condition that deactivated the system is no longer present, the system will return to the “Adaptive Cruise Control Off” state and will resume function by simply reactivating it.

#### NOTE:

If the “ACC/AEB Unavailable Wipe Front Radar Sensor” message occurs frequently (e.g. more than once on every trip) without any snow, rain, mud, or other obstructions, have the radar sensor realigned at an authorized dealer.

#### “CLEAN FRONT WINDSHIELD” WARNING

The “ACC/AEB Limited Functionality Clean Front Windshield” warning will display and a chime will sound when conditions temporarily limit system performance. This most often occurs at times of poor visibility, such as in snow or heavy rain and fog. The ACC system may also become temporarily blinded due to obstructions, such as mud, dirt, or ice on windshield, driving directly into the sun and fog on the inside of glass. In these cases, the instrument cluster display will show “ACC/AEB Limited Functionality Clean Front Windshield” and the system will have degraded performance.

The “ACC/AEB Limited Functionality Clean Front Windshield” message can sometimes be displayed while driving in adverse weather conditions. The ACC/FCW system will recover after the vehicle has left these areas. Under rare conditions, when the camera is not tracking any vehicles or objects in its path this warning may temporarily occur.

If weather conditions are not a factor, the driver should examine the windshield and the camera located on the back side of the inside rearview mirror. They may require cleaning or removal of an obstruction.

When the condition that created limited functionality is no longer present, the system will return to full functionality.

#### NOTE:

If the “ACC/AEB Limited Functionality Clean Front Windshield” message occurs frequently (e.g. more than once on every trip) without any snow, rain, mud, or other obstructions, have the windshield and forward facing camera inspected at an authorized dealer.

#### SERVICE ACC/FCW WARNING

If the system turns off, and the instrument cluster displays “ACC/FCW Unavailable Service Required” or “Cruise/FCW Unavailable Service Required”, there may be an internal system fault or a temporary malfunction that limits ACC functionality. Although the vehicle is still drivable under normal conditions, ACC will be temporarily unavailable. If this occurs, try activating ACC again later, following an ignition cycle. If the problem persists, see an authorized dealer.

## Precautions While Driving With ACC

In certain driving situations, ACC may have detection issues. In these cases, ACC may brake late or unexpectedly. The driver needs to stay alert and may need to intervene. The following are examples of these types of situations:

### TOWING A TRAILER

Towing a trailer is not recommended when using ACC.

### OFFSET DRIVING

ACC may not detect a vehicle in the same lane that is offset from your direct line of travel, or a vehicle merging in from a side lane. There may not be sufficient distance to the vehicle ahead. The offset vehicle may move in and out of the line of travel, which can cause your vehicle to brake or accelerate unexpectedly.

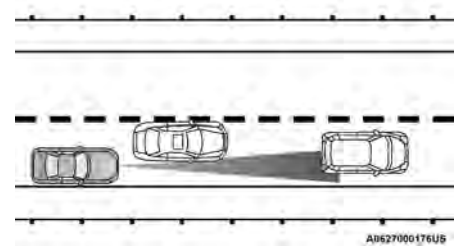

Offset Driving Condition Example

## URNS AND BENDS

When driving on a curve with ACC engaged, the system may increase or decrease the vehicle speed for stability, with no vehicle ahead detected. Once the vehicle is out of the curve, the system will resume your original set speed. This is a part of normal ACC system functionality.

### NOTE:

On tight turns ACC performance may be limited.

## USING ACC ON HILLS

ACC performance may be limited when driving on hills. ACC may not detect a vehicle in your lane depending on the speed, vehicle load, traffic conditions, and the steepness of the hill.

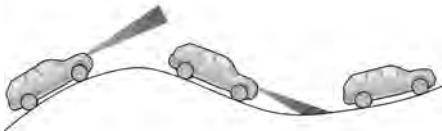

ACC Hill Example

AD627000175U5

## LANE CHANGING

ACC may not detect a vehicle until it is completely in the lane in which you are traveling. In the following lane changing example, ACC has not yet detected the vehicle changing lanes and it may not detect the vehicle until it's too late for the ACC system to take action. ACC may not detect a vehicle until it is completely in the lane. There may not be sufficient distance to the lane-changing vehicle. Always be attentive and ready to apply the brakes if necessary.

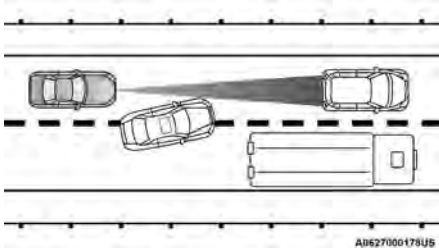

Lane Changing Example

AD627000178U5

## NARROW VEHICLES

Some narrow vehicles traveling near the outer edges of the lane or edging into the lane are not detected until they have moved fully into the lane. There may not be sufficient distance to the vehicle ahead.

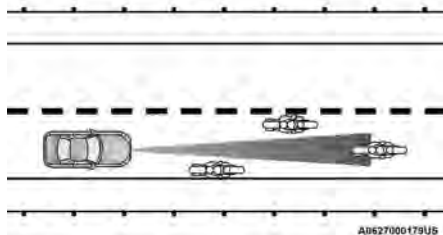

AD627000179U5

Narrow Vehicle Example

## STATIONARY OBJECTS AND VEHICLES

ACC does not react to stationary objects or vehicles. For example, ACC will not react in situations where the vehicle you are following exits your lane and the vehicle ahead is stopped in your lane. It will consider this stopped vehicle a stationary object as it did not previously detect movement from it. Always be attentive and ready to apply the brakes if necessary.

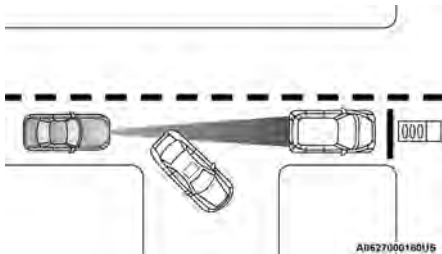

AD627000180U5

Stationary Object And Stationary Vehicle Example

## PARKSENSE FRONT/REAR PARK ASSIST SYSTEM — IF EQUIPPED

The ParkSense Park Assist system provides visual and audible indications of the distance between the rear, and if equipped, the front fascia/bumper and a detected obstacle when backing up or moving forward (e.g. during a parking maneuver). The vehicle brakes may be automatically applied and released when performing a parking maneuver if the system detects a possible collision with an obstacle.

### NOTE:

- The driver can override the automatic braking function by pressing the gas pedal over 90% of its capacity during the braking event, turning ParkSense off via the ParkSense switch, or changing the gear while the automatic brakes are being applied.
- Automatic brakes will not be available if ESC is not available.
- Automatic brakes will not be available if there is a faulted condition detected with the ParkSense Park Assist system or the Braking System Module.
- The automatic braking function may not provide enough vehicle deceleration to avoid colliding with a detected obstacle depending on vehicle speed, road conditions, and brake capability.
- The automatic braking function may not be applied fast enough for moving obstacles that approach the rear of the vehicle from the left and/or right sides.

- The automatic braking function can be enabled/disabled from the Customer-Programmable Features section of the Uconnect system.
- ParkSense will retain its last known configuration state for the automatic braking function through ignition cycles.

The automatic braking function is intended to assist the driver in avoiding possible collisions with detected obstacles when backing up in REVERSE.

### NOTE:

- The system is designed to assist the driver and not to substitute the driver.
- The driver must stay in full control of the vehicle's acceleration and braking and is responsible for the vehicle's movements.

For limitations of this system and recommendations, see [page 148](#).

ParkSense will retain the last system state (enabled or disabled) from the last ignition cycle when the ignition is changed to the ON/RUN position.

ParkSense can be active only when the gear selector is in REVERSE or DRIVE. If ParkSense is enabled at one of these gear selector positions, the system will remain active until the vehicle speed is increased to approximately 7 mph (11 km/h) or above. When in REVERSE and above the system's operating speed, a warning will appear in the instrument cluster display indicating the vehicle speed is too fast. The system will become active again if the vehicle speed is decreased to less than approximately 6 mph (9 km/h).

## PARKSENSE SENSORS

The six ParkSense sensors (four when vehicle is not equipped with front sensors), located in the rear fascia/bumper, and the six ParkSense sensors located in the front fascia/bumper, monitor the area in front and behind the vehicle that is within the sensors' field of view. The front sensors detect obstacles from approximately 12 inches (30 cm) up to 47 inches (120 cm) from the front fascia/bumper. The rear sensors can detect obstacles from approximately 12 inches (30 cm) up to 79 inches (200 cm) from the rear fascia/bumper. These distances depend on the location, type and orientation of the obstacle in the horizontal direction.

4

## PARKSENSE DISPLAY

The warning display will turn on indicating the system status when the vehicle is in REVERSE or when the vehicle is in DRIVE and an obstacle has been detected.

The system will indicate a detected obstacle by showing a single arc in the left and/or right front or rear regions based on the object's distance and location relative to the vehicle.

If an object is detected in the left and/or right rear region, the display will show a single arc in the left and/or right rear region and the system will produce a tone. As the vehicle moves closer to the object, the display will show the single arc moving closer to the vehicle and the tone will change from a single 1/2 second tone to slow, to fast, to continuous.

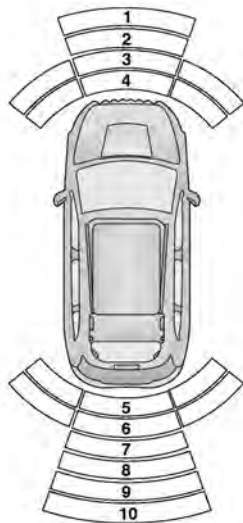

**ParkSense Arcs**

A0629000270US

- 1 – No Tone/Solid Arc
- 2 – No Tone/Flashing Arc
- 3 – Fast Tone/Flashing Arc
- 4 – Continuous Tone/Flashing Arc
- 5 – Continuous Tone/Flashing Arc

- 6 – Fast Tone/Flashing Arc
- 7 – Fast Tone/Flashing Arc
- 8 – Slow Tone/Solid Arc
- 9 – Slow Tone/Solid Arc
- 10 – Single 1/2 Second Tone/Solid Arc

The vehicle is close to the obstacle when the warning display shows one flashing arc and sounds a continuous tone. The following charts show the warning alert operation when the system is detecting an obstacle:

WARNING ALERTS FOR REAR							
Rear Distance (inches/cm)	Greater than 79 inches (200 cm)	79-59 inches (200-150 cm)	59-47 inches (150-120 cm)	47-39 inches (120-100 cm)	39-25 inches (100-65 cm)	25-12 inches (65-30 cm)	Less than 12 inches (30 cm)
Arcs – Left	None	None	None	None	None	6th Flashing	5th Flashing
Arcs – Center	None	10th Solid	9th Solid	8th Solid	7th Flashing	6th Flashing	5th Flashing
Arcs – Right	None	None	None	None	None	6th Flashing	5th Flashing
Audible Alert Chime	None	Single 1/2 Second Tone (for rear center only)	Slow (for rear center only)	Slow (for rear center only)	Fast (for rear center only)	Fast	Continuous
Radio Volume Reduced	No	Yes	Yes	Yes	Yes	Yes	Yes

WARNING ALERTS FOR FRONT					
Front Distance (inches/cm)	Greater than 47 inches (120 cm)	47-39 inches (120-100 cm)	39-25 inches (100-65 cm)	25-12 inches (65-30 cm)	Less than 12 inches (30 cm)
Arcs – Left	None	None	None	3rd Flashing	4th Flashing
Arcs – Center	None	1st Solid	2nd Flashing	3rd Flashing	4th Flashing
Arcs – Right	None	None	None	3rd Flashing	4th Flashing
Audible Alert Chime	None	None	None	Fast	Continuous
Radio Volume Reduced	No	No	No	Yes	Yes

**NOTE:**

ParkSense will reduce the volume of the radio, if on, when the system is sounding an audio tone.

### Front Park Assist Audible Alerts

ParkSense will turn off the Front Park Assist audible alert (chime) after approximately three seconds when an obstacle has been detected, the vehicle is stationary, and brake pedal is applied.

### Adjustable Chime Volume Settings

Front and Rear chime volume settings can be selected from the Uconnect system → page 169.

If the Uconnect system is equipped, chime volume settings will not be accessible from the instrument cluster display.

The chime volume settings include LOW, MEDIUM, and HIGH.

ParkSense will retain its last known configuration state through ignition cycles.

## PARKSENSE WARNING DISPLAY

The ParkSense Warning screen will only be displayed if "Sound and Display" is selected in the Uconnect system → page 169.

The ParkSense Warning screen is located within the instrument cluster display → page 103. It provides visual warnings to indicate the distance between the rear fascia/bumper and/or front fascia/bumper and the detected obstacle.

## ENABLING AND DISABLING PARKSENSE



ParkSense can be enabled and disabled with the ParkSense switch located below the Uconnect display.

When the ParkSense switch is pushed to disable the system, the instrument cluster will display the "ParkSense Off" message for approximately five

seconds. When the gear selector is moved to REVERSE and the system is disabled, the instrument cluster display will show the "ParkSense Off" message for as long as the vehicle is in REVERSE.

The ParkSense switch LED will be on when ParkSense is disabled or requires service. The ParkSense switch LED will be off when the system is enabled. If the ParkSense switch is pushed, and requires service, the ParkSense switch LED will blink momentarily, and then the LED will be on.

### NOTE:

When KeySense feature is present, the ParkSense system will reject customer input to turn the system off via the switch. The instrument cluster display will show "KeySense in Use Selected Feature Cannot be Disabled" message.

## SERVICE THE PARKSENSE PARK ASSIST SYSTEM

During vehicle start up, when the ParkSense system has detected a faulted condition, the instrument cluster will actuate a single chime, once per ignition cycle, and it will display the "ParkSense Unavailable Wipe Rear Sensors", "ParkSense Unavailable Wipe Front Sensors", or the "ParkSense Unavailable Service Required" message for five seconds. When the gear selector is moved to REVERSE and the system has detected a faulted condition, the instrument cluster display will show a "ParkSense Unavailable Wipe Rear Sensors", "ParkSense Unavailable Wipe Front Sensors" or "ParkSense Unavailable Service Required" pop-up message for five seconds. After five seconds, a vehicle graphic will be displayed with a "WIPE OFF" or "SERVICE" overlay, depending on the location and fault type. The system will continue to provide arc alerts for the side that is functioning properly.

These arc alerts will interrupt the "ParkSense Unavailable Wipe Rear Sensors", "ParkSense Unavailable Wipe Front Sensors", or "ParkSense Unavailable Service Required" messages if an object is detected within the five second pop-up duration. The vehicle graphic will remain displayed for as long as the vehicle is in REVERSE.

If "ParkSense Unavailable Wipe Rear Sensors", "ParkSense Unavailable Wipe Front Sensors" appears in the instrument cluster display make sure the outer surface and the underside of the rear fascia/bumper and/or front fascia/bumper is clean and clear of snow, ice, mud, dirt or other obstructions and then cycle the ignition. If the message continues to appear see an authorized dealer.

If the "ParkSense Unavailable Service Required" message appears in the instrument cluster display, see an authorized dealer.

## CLEANING THE PARKSENSE SYSTEM

Clean the ParkSense sensors with water, car wash soap and a soft cloth. Do not use rough or hard cloths. Do not scratch or poke the sensors.

## PARKSENSE SYSTEM USAGE PRECAUTIONS

### NOTE:

- Ensure that the front and rear fascia/bumper are free of snow, ice, mud, dirt, and debris to keep the ParkSense system operating properly.
- Construction equipment, large trucks, and other vibrations could affect the performance of ParkSense.

- When you turn ParkSense off, the instrument cluster will display “ParkSense Off.” Furthermore, once you turn ParkSense off, it remains off until you turn it on again, even if you cycle the ignition key.
- When you move the gear selector to the REVERSE position and ParkSense is turned off, the instrument cluster will display “ParkSense Off” for as long as the vehicle is in REVERSE.
- ParkSense, when on, will reduce the volume of the radio when it is sounding a tone.
- Clean the ParkSense sensors regularly, taking care not to scratch or damage them. The sensors must not be covered with ice, snow, slush, mud, dirt or debris. Failure to do so can result in the system not working properly. The ParkSense system might not detect an obstacle behind or in front of the appropriate fascia/bumper, or it could provide a false indication that an obstacle is behind or in front of the appropriate fascia/bumper.
- Use the ParkSense switch to turn the ParkSense system off if objects such as bicycle carriers, trailer hitches, etc., are placed within 12 inches (30 cm) from the rear fascia/bumper. Failure to do so can result in the system misinterpreting a close object as a sensor problem, causing the “ParkSense Unavailable Wipe Rear Sensors” message to be displayed in the instrument cluster.
- ParkSense should be disabled when the liftgate is in the open position. An opened liftgate could provide a false indication that an obstacle is behind the vehicle.
- There may be a delay in the object detection rate if the object is moving. This may cause the automatic braking application to be delayed.

**WARNING!**

- Drivers must be careful when backing up even when using ParkSense. Always check carefully behind your vehicle, look behind you, and be sure to check for pedestrians, animals, other vehicles, obstructions, and blind spots before backing up. You are responsible for safety and must continue to pay attention to your surroundings. Failure to do so can result in serious injury or death.
- Before using ParkSense, it is strongly recommended that the ball mount and hitch ball assembly be disconnected from the vehicle when the vehicle is not used for towing. Failure to do so can result in injury or damage to vehicles or obstacles because the hitch ball will be much closer to the obstacle than the rear fascia/bumper when the vehicle sounds the continuous tone. Also, the sensors could detect the ball mount and hitch ball assembly, depending on its size and shape, giving a false indication that an obstacle is behind the vehicle.

**CAUTION!**

- ParkSense is only a parking aid and it is unable to recognize every obstacle, including small obstacles. Parking curbs might be temporarily detected or not detected at all. Obstacles located above or below the sensors will not be detected when they are in close proximity.
- The vehicle must be driven slowly when using ParkSense in order to be able to stop in time when an obstacle is detected. It is recommended that the driver looks over his/her shoulder when using ParkSense.

## PARKSENSE ACTIVE PARK ASSIST SYSTEM — IF EQUIPPED

The ParkSense Active Park Assist system is intended to assist the driver during parallel and perpendicular parking maneuvers by identifying a proper parking space, providing audible/visual instructions, and controlling the steering wheel. The ParkSense Active Park Assist system is defined as “semi-automatic” since the driver maintains control of the accelerator, gear selector and brakes. Depending on the driver's parking maneuver selection, the ParkSense Active Park Assist system is capable of maneuvering a vehicle into a parallel or a perpendicular parking space on either side (i.e., driver side or passenger side).

**NOTE:**

- The driver is always responsible for controlling the vehicle, responsible for any surrounding objects, and must intervene as required.
- The system is designed to assist the driver and not to substitute the driver.
- During a semi-automatic maneuver, if the driver touches the steering wheel after being instructed to remove their hands from the steering wheel, the system will cancel, and the driver will be required to manually complete the parking maneuver.
- The system may not work in all conditions (e.g. environmental conditions such as heavy rain, snow, etc., or if searching for a parking space that has surfaces that will absorb the ultrasonic sensor waves).

- New vehicles from the dealership must have at least 30 miles (48 km) accumulated before the ParkSense Active Park Assist system is fully calibrated and performs accurately. This is due to the system's dynamic vehicle calibration to improve the performance of the feature.
- The use of wheels and tires that are different size to the original equipment could affect the operation of the system.

## ENABLING AND DISABLING THE PARKSENSE ACTIVE PARK ASSIST SYSTEM

The ParkSense Active Park Assist system can be enabled and disabled with the ParkSense Active Park Assist switch, located on the switch panel below the Uconnect display.



To enable or disable the ParkSense Active Park Assist system, push the ParkSense Active Park Assist switch once (LED turns on). Pushing the switch a second time will disable the system (LED turns off).

The ParkSense Active Park Assist system will turn off automatically for any of the following conditions:

- Parking maneuver is completed.
- Vehicle speed is greater than 18 mph (30 km/h) when searching for a parking space.
- Vehicle speed is greater than 5 mph (7 km/h) during active steering guidance into the parking space.
- Steering wheel is touched during active steering guidance into the parking space.
- ParkSense switch is pushed.
- The driver's door is opened.

- The liftgate is opened.
- Electronic Stability Control/Anti-Lock Braking System intervention.

The ParkSense Active Park Assist system will allow a maximum numbers of shifts between DRIVE and REVERSE. If the maneuver cannot be completed within eight shifts, the system will cancel and the instrument cluster display will instruct the driver to complete the maneuver manually.

The ParkSense Active Park Assist system will only operate and search for a parking space when the following conditions are present:

- The gear selector is in DRIVE.
- The ignition is in the RUN position.
- The ParkSense Active Park Assist switch is activated.
- The driver's door is closed.
- The liftgate is closed.
- Vehicle speed is less than 15 mph (25 km/h).
- The outer surface and the underside of the front and rear fascias/bumpers are clean and clear of snow, ice, mud, dirt or other obstructions.

When pushed, the LED on the ParkSense Active Park Assist switch will blink momentarily, and then the LED will turn off if any of the previously listed conditions are not present.

### NOTE:

If the vehicle is driven above approximately 15 mph (25 km/h), the instrument cluster display will instruct the driver to slow down. If the vehicle is driven above approximately 18 mph (30 km/h), the system will cancel. The driver must then reactivate the system by pushing the ParkSense Active Park Assist switch.

## PARALLEL/PERPENDICULAR PARKING SPACE ASSISTANCE OPERATION

When the ParkSense Active Park Assist system is enabled the default mode is parallel park. A message, "Active ParkSense Searching - Push OK for Perpendicular Park" will appear in the instrument cluster display. Push the OK button on the left side steering wheel switch to change your parking space setting to parallel or perpendicular. Once the driver pushes OK for a perpendicular parking maneuver, the "Active ParkSense Searching - Push OK for Parallel Park" message will appear in the instrument cluster display.

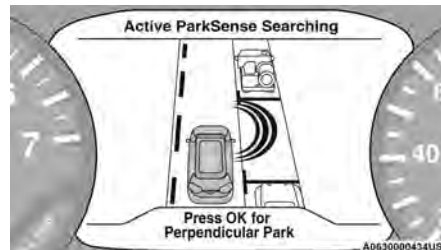

Active ParkSense Searching - Press OK for Perpendicular



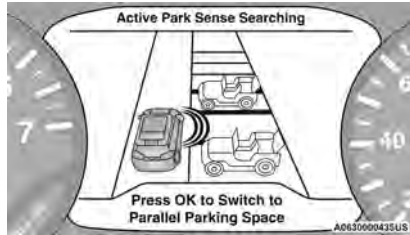

#### Active ParkSense Searching - Press OK for Parallel Parking Space

#### NOTE:

- When searching for a parking space, use the turn signal indicator to select which side of the vehicle you want to perform the parking maneuver. The ParkSense Active Park Assist system will automatically search for a parking space on the passenger's side of the vehicle if the turn signal is not activated.
- The driver needs to make sure that the selected parking space for the maneuver remains free and clear of any obstructions (e.g. pedestrians, bicycles, etc.).
- The driver is responsible to ensure that the selected parking space is suitable for the maneuver and free/clear of anything that may be overhanging or protruding into the parking space (e.g., ladders, tailgates, etc., from surrounding objects/vehicles).
- When searching for a parking space, the driver should drive as parallel or perpendicular (depending on the type of maneuver) to other vehicles as possible.

- The feature will only indicate the last detected parking space (example: if passing multiple available parking spaces, the system will only indicate the last detected parking space for the maneuver).

When an available parking space has been found, and the vehicle is not in position, you will be instructed to move forward to position the vehicle for a perpendicular or parallel parking sequence (depending on the type of maneuver being performed).

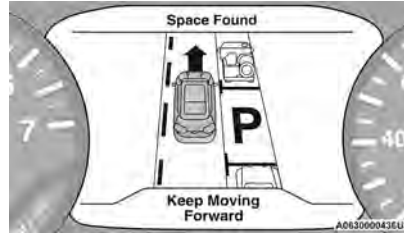

#### Space Found – Keep Moving Forward

Once the vehicle is in position, you will be instructed to stop the vehicle's movement and remove your hands from the steering wheel. When the vehicle comes to a standstill (your hands still removed from the steering wheel), you will be instructed to place the gear selector into the REVERSE position.

The system may then instruct the driver to wait for steering to complete before then instructing to check surroundings and move backward.

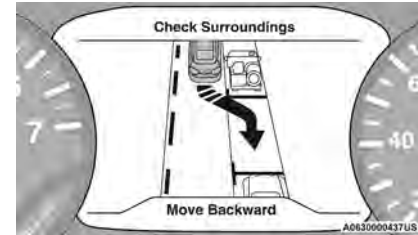

#### Move Backward Into Parallel Parking Space

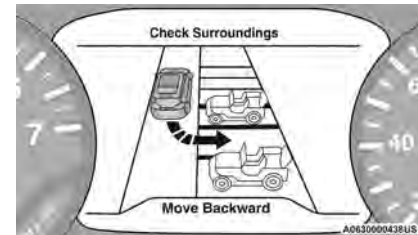

#### Move Backward Into Perpendicular Parking Space

The system may instruct several more gear shifts (DRIVE and REVERSE), with hands off of the steering wheel, before instructing the driver to check surroundings and complete the parking maneuver.

When the vehicle is in the parking position, the maneuver is complete and the driver will be instructed to check the vehicle's parking position, then shift the vehicle into PARK. The message "Active ParkSense Complete - Check Parking Position" will be displayed momentarily.

**NOTE:**

- It is the driver's responsibility to maintain a clear line of sight with the instrument cluster display for driving instructions during a parking maneuver.
- It is the driver's responsibility to use the brake and accelerator during the semi-automatic parking maneuver.
- It is the driver's responsibility to use the brake and stop the vehicle. The driver should check their surroundings and be prepared to stop the vehicle either when instructed to, or when driver intervention is required.
- When the system instructs the driver to remove their hands from the steering wheel, the driver should check their surroundings and begin to back up slowly. All instructions will appear in the instrument cluster display.
- The ParkSense Active Park Assist system will allow a maximum number of shifts between DRIVE and REVERSE. If the maneuver cannot be completed within six shifts, the system will cancel and the instrument cluster display will instruct the driver to complete the maneuver manually.
- The system will cancel the maneuver if the vehicle speed exceeds 5 mph (7 km/h) during active steering guidance into the parking space. The system will provide a warning to the driver at 3 mph (5 km/h) that tells them to slow down. The driver is then responsible for completing the maneuver if the system is canceled.
- If the system is canceled during the maneuver for any reason, the driver must take control of the vehicle.

**WARNING!**

Drivers must be careful when performing parallel or perpendicular parking maneuvers even when using the ParkSense Active Park Assist system. Always check carefully behind and in front of your vehicle, look behind and in front of you, and be sure to check for pedestrians, animals, other vehicles, obstructions, and blind spots before backing up and moving forward. You are responsible for safety and must continue to pay attention to your surroundings. Failure to do so can result in serious injury or death.

**CAUTION!**

- The ParkSense Active Park Assist system is only a parking aid and it is unable to recognize every obstacle, including small obstacles. Parking curbs might be temporarily detected or not detected at all. Obstacles located above or below the sensors will not be detected when they are in close proximity.
- The vehicle must be driven slowly when using the ParkSense Active Park Assist system in order to be able to stop in time when an obstacle is detected. It is recommended that the driver looks over his/her shoulder when using the ParkSense Active Park Assist system.

**LANESENSE — IF EQUIPPED****LANESENSE OPERATION**

The LaneSense system is operational at speeds above 37 mph (60 km/h) and below 11.2 mph (180 km/h). It uses a forward facing camera to detect lane markings and measure vehicle position within the lane boundaries.

When both lane markings are detected and the driver drifts out of the lane (no turn signal applied), the LaneSense system provides a haptic warning in the form of torque applied to the steering wheel, as well as a visual warning in the instrument cluster display, to prompt the driver to remain within the lane boundaries.

The driver may manually override the haptic warning by applying force to the steering wheel at any time.

When only a single lane marking is detected and the driver unintentionally drifts across that lane marking (no turn signal applied), the LaneSense system provides a visual warning through the instrument cluster display to prompt the driver to remain within the lane. When only a single lane marking is detected, a haptic or a torque warning will not be provided.

**NOTE:**

When operating conditions have been met, the LaneSense system will monitor if the driver's hands are on the steering wheel and provide an audible and visual warning to the driver when the driver's hands are not detected on the steering wheel. The system will cancel if the driver does not return their hands to the wheel.

## TURNING LANESENSE ON OR OFF



The LaneSense button is located on the switch panel below the Uconnect display.

To turn the LaneSense system on, push the LaneSense button (LED turns off). A “LaneSense On” message is shown in the instrument cluster display.

To turn the LaneSense system off, push the LaneSense button again (LED turns on).

### NOTE:

The LaneSense system will retain the last system state on or off from the last ignition cycle when the ignition is changed to the ON/RUN position.

## LANESENSE WARNING MESSAGE

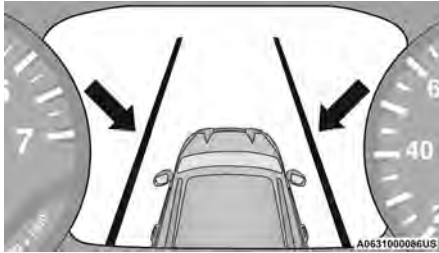

The LaneSense system will indicate the current lane drift condition through the instrument cluster display.

When the LaneSense system is on, the lane lines are gray when both of the lane boundaries have not been detected and the LaneSense telltale  is solid white.



System ON (Gray Lines) With White Telltale

### Left Lane Departure — Only Left Lane Detected

- When the LaneSense system is on, the LaneSense Telltale  is solid white only when the left lane marking has been detected and the system is ready to provide visual warnings in the instrument cluster display if an unintentional lane departure occurs on the left side.
- When the LaneSense system senses the lane has been approached and is in a lane departure situation, the visual warning in the instrument cluster display will show the left inside lane line flashing yellow (on/off), while the outside lane line on the left of the display will remain solid yellow. The LaneSense telltale  changes from solid white to flashing yellow.

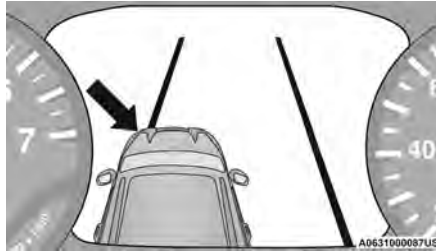

Lane Approached With Flashing Yellow Line/Flashing Yellow Telltale

### NOTE:

The LaneSense system operates with similar behavior for a right lane departure when only the right lane marking has been detected.

### Left Lane Departure — Both Lane Lines Detected

- When the LaneSense system is on, the lane lines turn from gray to white. The LaneSense telltale  is solid green when both lane markings have been detected and the system is ready to provide visual warnings in the instrument cluster display and a torque warning in the steering wheel if an unintentional lane departure occurs.

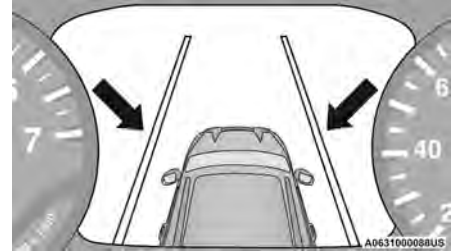

Lanes Sensed (White Lines) With Green Telltale

- When the LaneSense system senses a lane drift situation, the left inside and outside lane lines turn solid yellow. The LaneSense telltale  changes from solid green to solid yellow. At this time torque is applied to the steering wheel in the opposite direction of the lane boundary.

For example: If approaching the left side of the lane the steering wheel will turn to the right.

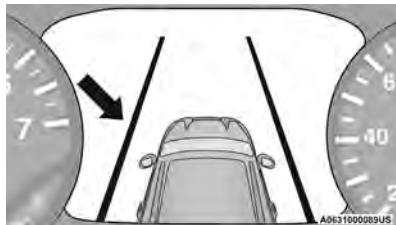

**Lane Drift With Solid Yellow Line/Solid Yellow Telltale**

- When the LaneSense system senses the lane has been approached and is in a lane departure situation, the left inside lane line flashes yellow (on/off) while the left outside line remains solid yellow. The LaneSense telltale  changes from solid yellow to flashing yellow. At this time torque is applied to the steering wheel in the opposite direction of the lane boundary.

For example: If approaching the left side of the lane the steering wheel will turn to the right.

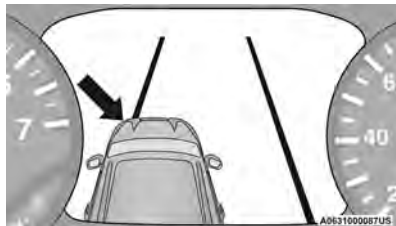

**Lane Approached With Flashing Yellow Line/Flashing Yellow Telltale**

**NOTE:**

The LaneSense system operates with similar behavior for a right lane departure.

## CHANGING LANESENSE STATUS

The LaneSense system has settings to adjust the intensity of the torque warning and the warning zone sensitivity (Early/Medium/Late) that you can configure through the Uconnect system  page 169.

**NOTE:**

- When enabled the system operates above 37 mph (60 km/h) and below 112 mph (180 km/h).
- The warnings are disabled with use of the turn signal.
- The system will not apply torque to the steering wheel whenever a safety system engages (Anti-Lock Brakes, Traction Control System, Electronic Stability Control, Forward Collision Warning, etc.).

## PARKVIEW REAR BACK UP CAMERA

The ParkView Rear Back Up Camera allows you to see an on-screen image of the rear surroundings of your vehicle whenever the gear selector is put into REVERSE. The image will be displayed on the touchscreen display along with a caution note "Check Entire Surroundings" across the top of the screen. After five seconds, this note will disappear. The ParkView Rear Back Up Camera is located on the rear of the vehicle above the rear license plate.

**NOTE:**

The ParkView Rear Back Up Camera has programmable modes of operation that may be selected through the Uconnect system  page 169.

When the vehicle is shifted out of REVERSE with camera delay turned off, the rear camera mode is exited and the previous screen appears.

When the vehicle is shifted out of REVERSE with camera delay turned on, the camera image will continue to be displayed for up to 10 seconds unless the vehicle speed exceeds 8 mph (13 km/h), the vehicle is shifted into PARK, or the ignition is placed in the OFF position.

A touchscreen X button to disable the camera image is made available when the vehicle is not in REVERSE gear. Display of the camera image after shifting out of REVERSE can be disabled through the camera settings menu with the Uconnect system.

When enabled, active guidelines are overlaid on the image to illustrate the width of the vehicle and its projected backup path based on the steering wheel position.

Different colored zones indicate the distance to the rear of the vehicle.

The following table shows the approximate distances for each zone:

Zone	Distance To The Rear Of The Vehicle
Red	0 - 1 ft (0 - 30 cm)
Yellow	1 ft - 6.5 ft (30 cm - 2 m)
Green	6.5 ft or greater (2 m or greater)

**NOTE:**

If snow, ice, mud, or any foreign substance builds up on the camera lens, clean the lens, rinse with water, and dry with a soft cloth. Do not cover the lens.

**WARNING!**

Drivers must be careful when backing up even when using the ParkView Rear Back Up Camera. Always check carefully behind your vehicle, and be sure to check for pedestrians, animals, other vehicles, obstructions, or blind spots before backing up. You are responsible for the safety of your surroundings and must continue to pay attention while backing up. Failure to do so can result in serious injury or death.

**CAUTION!**

- To avoid vehicle damage, ParkView should only be used as a parking aid. The ParkView camera is unable to view every obstacle or object in your drive path.
- To avoid vehicle damage, the vehicle must be driven slowly when using ParkView to be able to stop in time when an obstacle is seen. It is recommended that the driver look frequently over his/her shoulder when using ParkView.

## SURROUND VIEW CAMERA SYSTEM — IF EQUIPPED

Your vehicle may be equipped with the Surround View Camera system that allows you to see an on-screen image of the surroundings and Top View of your vehicle whenever the gear selector is put into REVERSE or a different view is selected through the touchscreen buttons. The Top View of the vehicle will show which doors are open. The image will be displayed on the touchscreen display along with a caution note “Check Entire Surroundings” across the top of the screen. After five seconds, this note will disappear. The Surround View Camera system is comprised of four sequential cameras located in the front grille, rear liftgate and side mirrors.

**NOTE:**

The Surround View Camera system has programmable settings that may be selected through the Uconnect system → page 169.



Press this button on the touchscreen to enter the Surround View Camera menu in the Uconnect system.

When the vehicle is shifted into REVERSE, the Rear View and Top View is the default view of the system.

When the vehicle is shifted out of REVERSE with camera delay turned on, the camera image will continue to be displayed for up to 10 seconds unless the vehicle speed exceeds 8 mph (13 km/h), the vehicle is shifted into PARK, or the ignition is placed in the OFF position. There is a touchscreen X button to disable the display of the camera image.

When the vehicle is shifted out of REVERSE with camera delay turned off, the Surround View system is exited and the last known screen appears again.

Whenever the Rear View Camera image is activated through the Back Up Camera button in the Controls menu, and the vehicle speed is greater than, or equal to, 8 mph (13 km/h), a display timer for the image is initiated. The image will continue to be displayed until the display timer exceeds 10 seconds.

**NOTE:**

- If the vehicle speed remains below 8 mph (13 km/h), the Rear View Camera image will be displayed continuously until deactivated via the touchscreen X button, the transmission is shifted into PARK, or the ignition is placed in the OFF position.
- The touchscreen X button to disable display of the camera image is made available ONLY when the vehicle is not in REVERSE.

When enabled, active guidelines are overlaid on the image to illustrate the width of the vehicle, including the side view mirrors and its projected back up path based on the steering wheel position.

Different colored zones indicate the distance to the rear of the vehicle.

The following table shows the approximate distances for each zone:

Zone	Distance To The Rear Of The Vehicle
Red	0 - 1 ft (0 - 30 cm)
Yellow	1 ft - 6.5 ft (30 cm - 2 m)
Green	6.5 ft or greater (2 m or greater)

### Modes Of Operation

Manual activation of the Surround View system is selected by pressing the Surround View Camera button located in the Controls screen within the Uconnect system.

#### Top View

The Top View will show in the Uconnect system with Rear View and Front View in a split screen display. There is integrated ParkSense arcs in the image at the front and rear of the vehicle. The arcs will change color from yellow to red corresponding the distance zones to the oncoming object.

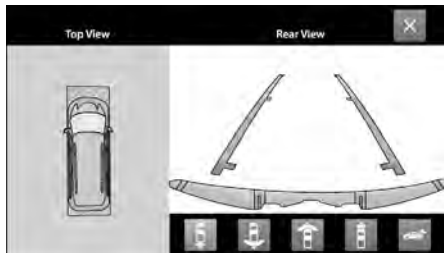

**Surround View Camera View**

#### NOTE:

- Front tires will be in image when the tires are turned.
- Due to wide angle cameras in the mirrors, the image will appear distorted.
- Top View will show which sliding doors are open.
- Open front doors will remove outside image.

#### Rear View Plus Top View



This is the default view of the system in REVERSE and is always paired with the Top View of the vehicle with optional active guidelines for the projected path when enabled.

#### Rear Cross Path View



Pressing the Rear Cross Path button will give the driver a wider angle view of the Rear View. The Top View will be disabled when this is selected.

#### Front View Plus Top View



Pressing the Front View button will show you what is immediately in front of the vehicle and is always paired with the Top View of the vehicle.

#### Front Cross Path View



Pressing the Front Cross Path button will give the driver a wider angle view of the Front View. The Top View will be disabled when this is selected.

#### Back Up Camera View



Pressing the Back Up Camera button will provide a full screen rear view with Zoom View.

#### Zoom View

When the Rear View is being displayed, and the vehicle speed is below 8 mph (13 km/h) while in any gear selector position, Zoom View is available. By pressing the “magnifying glass” icon in the upper left of the display screen, the image will zoom in to four times the standard view. Pressing the icon a second time will return the view to the standard Rear View.

When Zoom View is selected while the vehicle is in REVERSE, then shifted to DRIVE, the camera delay will display the standard Rear View. If the vehicle is then returned to REVERSE gear from DRIVE, the Zoom View selection will automatically resume.

Shifting to NEUTRAL from any gear will maintain the selected view (Zoom or Standard) as long as the vehicle speed is below 8 mph (13 km/h).

If the vehicle is in PARK, Zoom View is available until the gear selector is placed in DRIVE or REVERSE and speeds are at or above 8 mph (13 km/h).

#### NOTE:

- If the vehicle is in DRIVE, NEUTRAL, or REVERSE, and speed is greater than or equal to 8 mph (13 km/h), Zoom View is unavailable and the icon will appear gray.
- While in Zoom View, the guidelines will not be visible.

#### Deactivation

The system can be deactivated under the following conditions:

- The speed of the vehicle is greater than 8 mph (13 km/h).
- The vehicle shifted into PARK.
- The vehicle is in any gear other than REVERSE and the touchscreen X button is pressed.
- The camera delay system is turned off manually through the Uconnect Settings ⇄ page 169.

**NOTE:**

- If snow, ice, mud, or any foreign substance builds up on the camera lenses, clean the lenses, rinse with water, and dry with a soft cloth. Do not cover the lenses.
- If a malfunction with the system has occurred, see an authorized dealer.

**WARNING!**

Drivers must be careful when backing up even when using the Surround View Camera. Always check carefully behind your vehicle, and be sure to check for pedestrians, animals, other vehicles, obstructions, or blind spots before backing up. You are responsible for the safety of your surroundings and must continue to pay attention while backing up. Failure to do so can result in serious injury or death.

**CAUTION!**

- To avoid vehicle damage, Surround View should only be used as a parking aid. The Surround View camera is unable to view every obstacle or object in your drive path.
- To avoid vehicle damage, the vehicle must be driven slowly when using Surround View to be able to stop in time when an obstacle is seen. It is recommended that the driver look frequently over his/her shoulder when using Surround View.

**FAMCAM SYSTEM — IF EQUIPPED**

Your vehicle may be equipped with a FamCam system that consists of an interior monitoring camera mounted on the headliner that allows you to view cargo/passengers in the rear interior of the vehicle through the Uconnect screen.

To activate the feature, press the FamCam button under “Controls” in the Vehicle Menu of the Uconnect system ↩ page 169. Alternatively, the feature can be accessed through the App Drawer or a shortcut for the feature can be added to the Favorites bar at the top of the screen for quick access.

The display will show the entire vehicle cabin view on the left side of the display, and a zoomed-in view of a selected seat on the right side of the display.

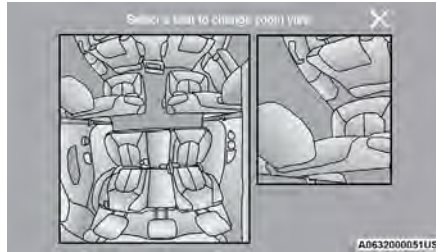

**FamCam Display (7 Passenger Vehicle Shown)**

To change the seat shown in the zoomed-in view, press a different seat location on the left side of the display. The zoomed-in view will then show the new seat location. By default, the second row driver's side seat will be displayed in the zoomed-in view.

The display will appear in color in well-lit conditions and will appear black and white in low-light conditions.

If the driver shifts into REVERSE or presses the touch-screen X button, the view will close. Otherwise, the FamCam view will remain on the display.

**NOTE:**

When FamCam is turned off, the selected seat in the zoomed-in view on the right side of the display will be retained. The next time the feature is activated, the same seat will be shown in the zoomed-in view.

**REFUELING THE VEHICLE**

There is no fuel filler cap. Two flapper doors inside the pipe seal the system.

**WARNING!**

- Never have any smoking materials lit in or near the vehicle when the fuel door is open or the tank is being filled.
- Never add fuel when the engine is running. This is in violation of most state and federal fire regulations and may cause the Malfunction Indicator Light to turn on.
- A fire may result if fuel is pumped into a portable container that is inside of a vehicle. You could be burned. Always place fuel containers on the ground while filling.

**CAUTION!**

To avoid fuel spillage and overfilling, do not “top off” the fuel tank after filling.

1. Put the vehicle in PARK and switch the ignition OFF.
2. Push the center-rear edge of the fuel filler door (3 o'clock position) and release to open.



**Fuel Filler Door**

3. Insert the fuel nozzle fully into the filler pipe; the nozzle opens and holds both flapper doors while refueling.
4. When the fuel nozzle "clicks" or shuts off, the fuel tank is full.
5. Keep the nozzle in the filler for five seconds after the nozzle clicks to allow fuel to drain from the nozzle.
6. Remove the fuel filler nozzle.
7. To close the fuel filler door, push the center-rear edge (3 o'clock position) of the fuel filler door and then release. The fuel filler door will latch closed.

**NOTE:**

In certain cold conditions, ice may prevent the fuel filler door from opening. If this occurs, lightly push on the fuel filler door around the perimeter to break the ice buildup.

## REFUELING THE VEHICLE — HYBRID MODELS (IF EQUIPPED)

1. Put the vehicle in the PARK position.
2. Push the fuel filler door release button (located in the driver's door in the upper map pocket).

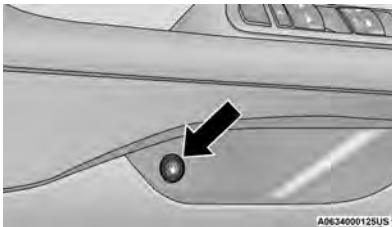

**Fuel Filler Door Release Switch**

3. The button push will initiate a sequence of events to depressurize the fuel system. A message will display in the cluster when the vehicle is ready to be fueled.



**Ready to  
Refuel**

AOE340001E3US

**Instrument Cluster Message**

**NOTE:**

- After pushing the release button you will have 20 minutes to fuel the vehicle; beyond 20 minutes you will need to push the release button again.
  - Under normal circumstances, the fuel door could take up to 15 seconds to open. It may take longer to open in some situations, such as high ambient temperatures.
  - If you hear a hissing sound when the nozzle is inserted into the filler pipe, wait to begin fueling the vehicle until after the hissing sound stops.
4. The fuel door pops away from the vehicle when it has been released. To finish opening the fuel door, manually rotate it away from the vehicle.

**NOTE:**

- If the service station fuel pump repeatedly clicks off (stops delivering fuel) before the fuel tank has been filled, push the fuel door release button again.
- If pushing the fuel door release button a second time does not correct the problem, try using a different fuel pump. If premature fuel pump shut-off continues to be a problem, take the vehicle to an authorized dealer for service.
- If the fuel door does not re-latch upon closure, push the fuel door release button again to reset the latch. If pushing the fuel door release button a second time does not correct the problem, take the vehicle to an authorized dealer for service.

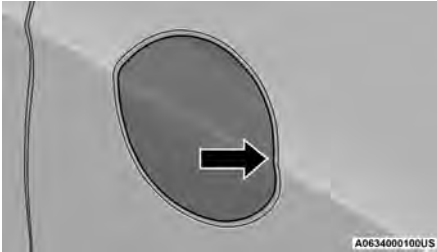

**Fuel Filler Door****NOTE:**

In certain cold conditions, ice may prevent the fuel door from opening. If this occurs, lightly push on the fuel door to break the ice buildup and re-release the fuel door using the inside release button. Do not pry on the door.

- There is no fuel filler cap. Two flapper doors inside the pipe seal the system.
- Insert the fuel nozzle fully into the filler pipe, the nozzle opens and holds both flapper doors while refueling.
- Fill the vehicle with fuel. When the fuel nozzle "clicks" or shuts off the fuel tank is full.
- Wait five seconds before removing the fuel nozzle to allow fuel to drain from nozzle.
- Remove the fuel nozzle and close the fuel door. Engage the fuel door latch by pushing on the rear outer edge near the center.

**WARNING!**

- Never have any smoking materials lit in or near the vehicle when the fuel door is open or the tank is being filled.
- Never add fuel when the engine is running. This is in violation of most state and federal fire regulations and may cause the Malfunction Indicator Light to turn on.
- A fire may result if fuel is pumped into a portable container that is inside of a vehicle. You could be burned. Always place fuel containers on the ground while filling.

**CAUTION!**

To avoid fuel spillage and overfilling, do not "top off" the fuel tank after filling.

**Emergency Fuel Door Release**

- Place the vehicle's ignition to the RUN position (Propulsion System Not Active).

**NOTE:**

If this is not performed, then the tank vent valve will not open. This will result in premature fuel pump shut-offs.

- Access the storage bin located behind the rear cargo trim panel.
- Remove access cover in the upper right corner.

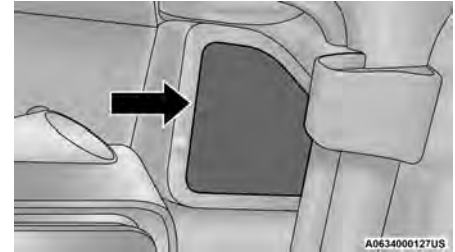
**Access Cover Location****4**

- After removing green handle from retention bracket, gently pull the green handle directly away from the bracket to release the fuel door.

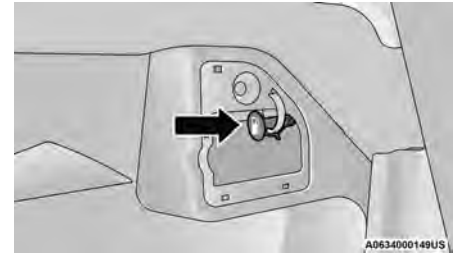
**Fuel Door Emergency Release****NOTE:**

Excessive force may break cable tether.

- Reinstall handle back into bracket when completed.
- Wait 15 seconds and then begin fueling your vehicle.

## VEHICLE LOADING

### CERTIFICATION LABEL

As required by National Highway Traffic Safety Administration regulations, your vehicle has a certification label affixed to the driver's side door or pillar.

This label contains the month and year of manufacture, Gross Vehicle Weight Rating (GVWR), front and rear Gross Axle Weight Rating (GAWR), and Vehicle Identification Number (VIN). A Month-Day-Hour (MDH) number is included on this label and indicates the Month, Day and Hour of manufacture. The bar code that appears on the bottom of the label is your VIN.

### Gross Vehicle Weight Rating (GVWR)

The GVWR is the total permissible weight of your vehicle including driver, passengers, vehicle, options and cargo. The label also specifies maximum capacities of front and rear GAWR. Total load must be limited so GVWR and front and rear GAWR are not exceeded.

### Payload

The payload of a vehicle is defined as the allowable load weight a truck can carry, including the weight of the driver, all passengers, options and cargo.

### Gross Axle Weight Rating (GAWR)

The GAWR is the maximum permissible load on the front and rear axles. The load must be distributed in the cargo area so that the GAWR of each axle is not exceeded.

Each axle GAWR is determined by the components in the system with the lowest load carrying capacity (axle, springs, tires or wheels). Heavier axles, or suspension components sometimes specified by purchasers for increased durability, do not necessarily increase the vehicle's GVWR.

### Tire Size

The tire size on the Vehicle Certification Label represents the actual tire size on your vehicle. Replacement tires must be equal to the load capacity of this tire size.

### Rim Size

This is the rim size that is appropriate for the tire size listed.

### Inflation Pressure

This is the cold tire inflation pressure for your vehicle for all loading conditions up to full GAWR.

### Curb Weight

The curb weight of a vehicle is defined as the total weight of the vehicle with all fluids, including vehicle fuel, at full capacity conditions, and with no occupants or cargo loaded into the vehicle. The front and rear curb weight values are determined by weighing your vehicle on a commercial scale before any occupants or cargo are added.

### Loading

The actual total weight and the weight of the front and rear of your vehicle at the ground can best be determined by weighing it when it is loaded and ready for operation.

The entire vehicle should first be weighed on a commercial scale to ensure that the GVWR has not been exceeded. The weight on the front and rear of the vehicle should then be determined separately to be sure that the load is properly distributed over the front and rear axle. Weighing the vehicle may show that the GAWR of either the front or rear axles has been exceeded but the total load is within the specified GVWR. If so, weight must be shifted from front to rear or

rear to front as appropriate until the specified weight limitations are met. Store the heavier items down low and be sure that the weight is distributed equally. Stow all loose items securely before driving.

Improper weight distributions can have an adverse effect on the way your vehicle steers and handles and the way the brakes operate.

#### WARNING!

Do not load your vehicle any heavier than the GVWR or the maximum front and rear GAWR. If you do, parts on your vehicle can break, or it can change the way your vehicle handles. This could cause you to lose control. Overloading can shorten the life of your vehicle.

## TRAILER TOWING

### NOTE:

Trailer towing is not permitted for the Plug-in Hybrid Electric Vehicle (PHEV).

In this section you will find safety tips and information on limits to the type of towing you can reasonably do with your vehicle. Before towing a trailer, carefully review this information to tow your load as efficiently and safely as possible.

To maintain the New Vehicle Limited Warranty coverage, follow the requirements and recommendations in this manual concerning vehicles used for trailer towing.

## COMMON TOWING DEFINITIONS

The following trailer towing related definitions will assist you in understanding the following information:

### Gross Vehicle Weight Rating (GVWR)

GVWR is the total allowable weight of your vehicle. This includes driver, passengers, cargo and tongue weight. The total load must be limited so that you do not exceed the GVWR → page 160.

### Gross Trailer Weight (GTW)

GTW is the weight of the trailer plus the weight of all cargo, consumables and equipment (permanent or temporary) loaded in or on the trailer in its "loaded and ready for operation" condition.

The recommended way to measure GTW is to put your fully loaded trailer on a vehicle scale. The entire weight of the trailer must be supported by the scale.

### Gross Combination Weight Rating (GCWR)

The GCWR is the total permissible weight of your vehicle and trailer when weighed in combination.

### Gross Axle Weight Rating (GAWR)

The GAWR is the maximum capacity of the front and rear axles. Distribute the load over the front and rear axles evenly. Make sure that you do not exceed either front or rear GAWR → page 160.

#### WARNING!

It is important that you do not exceed the maximum front or rear GAWR. A dangerous driving condition can result if either rating is exceeded. You could lose control of the vehicle and have a collision.

### Tongue Weight (TW)

The TW is the downward force exerted on the hitch ball by the trailer. You must consider this as part of the load on your vehicle.

### Trailer Frontal Area

The Frontal Area is the maximum height multiplied by the maximum width of the front of a trailer.

### Trailer Sway Control (TSC)

The TSC can be a mechanical telescoping link that can be installed between the hitch receiver and the trailer tongue that typically provides adjustable friction associated with the telescoping motion to dampen any unwanted trailer swaying motions while traveling.

The electronic TSC (if equipped), recognizes a swaying trailer and automatically applies individual wheel brakes and/or reduces engine power to attempt to eliminate the trailer sway.

### Weight-Carrying Hitch

A Weight-Carrying Hitch supports the trailer tongue weight, just as if it were luggage located at a hitch ball or some other connecting point of the vehicle. These kinds of hitches are commonly used to tow small and medium sized trailers.

### Weight-Distributing Hitch

A weight-distributing hitch works by applying leverage through spring (load) bars. They are typically used for heavier loads to distribute trailer tongue weight to the tow vehicle's front axle and the trailer axle(s). When used in accordance with the manufacturer's directions, it provides for a more level ride, offering more consistent steering and brake control thereby enhancing towing safety. The addition of a friction/hydraulic sway control also dampens sway caused by traffic and crosswinds and contributes positively to tow vehicle and trailer stability. TSC and a weight-distributing (load equalizing) hitch are recommended for heavier TW and may be required depending on vehicle and trailer configuration/loading to comply with GAWR requirements.

#### WARNING!

- An improperly adjusted weight-distributing hitch system may reduce handling, stability, braking performance, and could result in a collision.
- Weight-distributing systems may not be compatible with surge brake couplers. Consult with your hitch and trailer manufacturer or a reputable Recreational Vehicle dealer for additional information.

## TRAILER HITCH CLASSIFICATION

The following chart provides the industry standard for the maximum trailer weight a given trailer hitch class can tow and should be used to assist you in selecting the correct trailer hitch for your intended towing condition.

Trailer Hitch Classification Definitions	
Class	Max. Trailer Hitch Industry Standards
Class I - Light Duty	2,000 lb (907 kg)
Class II - Medium Duty	3,500 lb (1,587 kg)
Class III - Heavy Duty	6,000 lb (2,721 kg)
Class IV - Extra Heavy Duty	10,000 lb (4,535 kg)
Refer to the "Trailer Towing Weights (Maximum Trailer Weight Ratings)" chart for the Maximum Gross Trailer Weight (GTW) towable for your given drivetrain.	
All trailer hitches should be professionally installed on your vehicle.	

## TRAILER TOWING WEIGHTS (MAXIMUM TRAILER WEIGHT RATINGS)

The following chart provides the maximum trailer weight ratings towable for your given drivetrain.

Model	Trailer Tow Package	GCWR	Frontal Area	Maximum GTW	Maximum Trailer TW
<b>Touring L FWD</b>	Yes (Road Tripper)	8,600 lb (3,900 kg)	40 sq ft (3.72 sq m)	3,600 lb (1,632 kg)	360 lb (163 kg)
<b>Touring L AWD</b>	Yes (Road Tripper)	8,600 lb (3,900 kg)	40 sq ft (3.72 sq m)	3,550 lb (1,610 kg)	360 lb (163 kg)
<b>Limited FWD/AWD</b>	Yes	8,600 lb (3,900 kg)	40 sq ft (3.72 sq m)	3,600 lb (1,632 kg)	360 lb (163 kg)
<b>Pinnacle FWD</b>	Yes	8,600 lb (3,900 kg)	40 sq ft (3.72 sq m)	3,550 lb (1,610 kg)	360 lb (163 kg)
<b>Pinnacle AWD</b>	Yes	8,600 lb (3,900 kg)	40 sq ft (3.72 sq m)	3,600 lb (1,632 kg)	360 lb (163 kg)
<b>Vehicles using an aftermarket trailer hitch</b>	No	6,500 lb (2,948 kg)	40 sq ft (3.72 sq m)	1,200 lb (680 kg)	149 lb (67 kg)
Refer to local laws for maximum trailer towing speeds.					

### NOTE:

- The trailer tongue weight must be considered as part of the combined weight of occupants and cargo, and should never exceed the weight referenced on the Tire And Loading Information Placard.
- Trailer towing is not permitted with the hybrid vehicle.

## VEHICLE LOADING CHART

Follow these steps to determine the total weight the vehicle can carry:







- Determine the cargo capacity of your vehicle.
  - Load Capacity = GVWR – Curb (weight of vehicle, full fluids, no occupants).
- Determine occupant count.
  - For calculation purposes, average weight of an occupant is 150 lb (68 kg).



EXAMPLE:

- GVWR = 6,005 lb (2,723 kg)
- CURB = 4,500 lb (2,041 kg)
- Load Capacity = GVWR – CURB = 6,005 lb (2,723 kg) - 4,500 lb (2,041 kg) = 1,505 lb (682 kg)

4 Occupants (at 150 lb [68 kg]) + Max Trailer =

- 1,505 lb (682 kg) – 600 lb (272 kg) (4 x 150 lb [68 kg]) – 360 lb (163 kg) (10% of 3,600 lb [1,632 kg]) = 545 lb (247 kg) of cargo in vehicle

Number Of Persons / Weight Of Occupants	Max Cargo No Trailer	Max Trailer TW, Max Trailer	Max Cargo With Max Trailer TW 360 lb (163 kg)
 <p><b>2 People / 300 lb (136 kg)</b></p>	 <p><b>1,205 lb (546 kg)</b></p>	<p>1,205 lb (546 kg) – 360 lb (163 kg) = 845 lb (383 kg)</p>	 <p><b>845 lb (383 kg)</b></p>
 <p><b>4 people / 600 lb (272 kg)</b></p>	 <p><b>955 lb (433 kg)</b></p>	<p>955 lb (433 kg) – 360 lb (163 kg) = 545 lb (247 kg)</p>	 <p><b>545 lb (247 kg)</b></p>

Number Of Persons / Weight Of Occupants	Max Cargo No Trailer	Max Trailer TW, Max Trailer	Max Cargo With Max Trailer TW 360 lb (163 kg)
 <p data-bbox="388 319 618 339"><b>7 people / 1,050 lb (476 kg)</b></p>	 <p data-bbox="954 329 1081 350"><b>455 lb (206 kg)</b></p>	<p data-bbox="1139 246 1340 314">455 lb (206 kg) – 360 lb (163 kg) = 95 lb (43 kg)</p>	 <p data-bbox="1407 329 1518 350"><b>95 lb (43 kg)</b></p>

- Make sure loading does not exceed GAWR of front or rear axles.
- GAWR is found on the certification label affixed to the driver's side door jamb.

## TRAILER AND TONGUE WEIGHT

Never exceed the maximum tongue weight stamped on your fascia/bumper or trailer hitch.

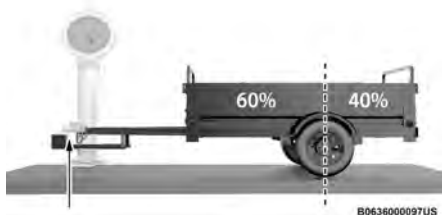

**Weight Distribution**

Consider the following items when computing the weight on the rear axle of the vehicle:

- The tongue weight of the trailer.
- The weight of any other type of cargo or equipment put in or on your vehicle.
- The weight of the driver and all passengers.

### NOTE:

Remember that everything put into or on the trailer adds to the load on your vehicle. Also, additional factory-installed options or dealer-installed options must be considered as part of the total load on your vehicle → page 294.

## TOWING REQUIREMENTS

To promote proper break-in of your new vehicle drive-train components, the following guidelines are recommended.

### CAUTION!

- Do not tow a trailer at all during the first 500 miles (805 km) the new vehicle is driven. The engine, axle or other parts could be damaged.
- Then, during the first 500 miles (805 km) that a trailer is towed, do not drive over 50 mph (80 km/h) and do not make starts at full throttle. This helps the engine and other parts of the vehicle wear in at the heavier loads.

Perform the maintenance listed in “Scheduled Servicing” → page 264. When towing a trailer, never exceed the GAWR or GCWR ratings.

**WARNING!**

Improper towing can lead to a collision. Follow these guidelines to make your trailer towing as safe as possible:

- Make certain that the load is secured in the trailer and will not shift during travel. When trailering cargo that is not fully secured, dynamic load shifts can occur that may be difficult for the driver to control. You could lose control of your vehicle and have a collision.
- When hauling cargo or towing a trailer, do not overload your vehicle or trailer. Overloading can cause a loss of control, poor performance or damage to brakes, axle, engine, transmission, steering, suspension, chassis structure or tires.
- Safety chains must always be used between your vehicle and trailer. Always connect the chains to the hook retainers of the vehicle hitch. Cross the chains under the trailer tongue and allow enough slack for turning corners.
- Vehicles with trailers should not be parked on a grade. When parking, apply the parking brake on the tow vehicle. Put the tow vehicle transmission in PARK. For four-wheel drive vehicles, make sure the transfer case is not in NEUTRAL. Always, block or "chock" the trailer wheels.
- GCWR must not be exceeded.
- **Total weight must be distributed between the tow vehicle and the trailer such that the following four ratings are not exceeded:**
  - GVWR
  - GTW
  - GAWR
  - Tongue weight rating for the trailer hitch utilized

**Towing Requirements — Tires**

- Do not attempt to tow a trailer while using a compact spare tire.
- Do not drive more than 50 mph (80 km/h) when towing while using a full size spare tire.
- Proper tire inflation pressures are essential to the safe and satisfactory operation of your vehicle.
- Check the trailer tires for proper tire inflation pressures before trailer usage.
- Check for signs of tire wear or visible tire damage before towing a trailer.
- Replacing tires with a higher load carrying capacity will not increase the vehicle's GVWR and GAWR limits.
- For further information ↗ page 291.

**Towing Requirements — Trailer Brakes**

- Do **not** interconnect the hydraulic brake system or vacuum system of your vehicle with that of the trailer. This could cause inadequate braking and possible personal injury.
- An electronically actuated trailer brake controller is required when towing a trailer with electronically actuated brakes. When towing a trailer equipped with a hydraulic surge actuated brake system, an electronic brake controller is not required.
- Trailer brakes are recommended for trailers over 1,000 lb (453 kg) and required for trailers in excess of 2,000 lb (907 kg).

**WARNING!**

- Do not connect trailer brakes to your vehicle's hydraulic brake lines. It can overload your brake system and cause it to fail. You might not have brakes when you need them and could have an accident.
- Towing any trailer will increase your stopping distance. When towing, you should allow for additional space between your vehicle and the vehicle in front of you. Failure to do so could result in an accident.

**CAUTION!**

If the trailer weighs more than 1,000 lb (453 kg) loaded, it should have its own brakes and they should be of adequate capacity. Failure to do this could lead to accelerated brake lining wear, higher brake pedal effort, and longer stopping distances.

**Towing Requirements — Trailer Lights And Wiring**

Whenever you pull a trailer, regardless of the trailer size, stop lights and turn signals on the trailer are required for motoring safety.

The Trailer Tow Package may include a four and seven-pin wiring harness. Use a factory approved trailer harness and connector.

**NOTE:**

Do not cut or splice wiring into the vehicle's wiring harness.

The electrical connections are all complete to the vehicle but you must mate the harness to a trailer connector. Refer to the following illustrations.

**NOTE:**

- Disconnect the trailer wiring connector from the vehicle (or any other device plugged into vehicle's electrical connectors) before launching a boat into water.
- Be sure to reconnect once clear from water area.

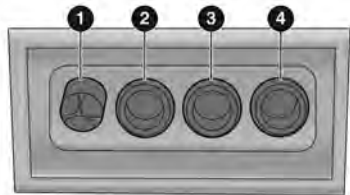

M0636000043US

**Four-Pin Connector**

- 1 – Ground
- 2 – Park
- 3 – Left Stop/Turn
- 4 – Right Stop/Turn

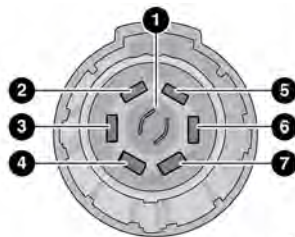

A0638000085US

**Seven-Pin Connector**

- 1 – Backup Lamps
- 2 – Running Lamps
- 3 – Left Stop/Turn
- 4 – Ground
- 5 – Battery
- 6 – Right Stop/Turn
- 7 – Electric Brakes

**TOWING TIPS**

Before towing, practice turning, stopping, and backing up the trailer in an area located away from heavy traffic.

**Automatic Transmission**

Select the DRIVE range when towing. The transmission controls include a drive strategy to avoid frequent shifting when towing. For increased engine braking on steep downhill grades, select the LOW range.

**Cruise Control — If Equipped**

- Do not use on hilly terrain or with heavy loads.
- When using the Cruise Control, if you experience speed drops greater than 10 mph (16 km/h), disengage until you can get back to cruising speed.
- Use Cruise Control in flat terrain and with light loads to maximize fuel efficiency.

**TRAILER TOWING — HYBRID MODELS (IF EQUIPPED)**

Trailer towing is not permitted with this vehicle.



## RECREATIONAL TOWING (BEHIND MOTORHOME)

### TOWING THIS VEHICLE BEHIND ANOTHER VEHICLE

Towing Condition	Wheel OFF The Ground	FWD Models	AWD Models
Flat Tow	NONE	<b>NOT ALLOWED</b>	<b>NOT ALLOWED</b>
Dolly Tow	Front	OK	<b>NOT ALLOWED</b>
	Rear	<b>NOT ALLOWED</b>	<b>NOT ALLOWED</b>
On Trailer	ALL	OK	OK

#### NOTE:

- To avoid inadvertent Electric Park Brake (EPB) engagement, you must ensure that the Auto Park Brake feature is disabled before towing this vehicle (if rear wheels are on the ground). The Auto Park Brake feature is enabled or disabled via the customer programmable features ↪ page 169.
- When towing your vehicle, always follow applicable state and provincial laws. Contact state and provincial Highway Safety offices for additional details.
- If your vehicle is disabled and in need of commercial towing service, for further information ↪ page 261.

**DO NOT** flat tow this vehicle. Damage to the drivetrain will result.

#### CAUTION!

- DO NOT flat tow this vehicle. Damage to the drivetrain will result. If this vehicle requires towing, make sure the drive wheels are OFF the ground.
- Ensure that the EPB is released, and remains released, while being towed.

(Continued)

#### CAUTION!

- Towing this vehicle in violation of the previously stated requirements can cause severe transmission damage. Damage from improper towing is not covered under the New Vehicle Limited Warranty.

#### Recreational Towing

##### Front-Wheel Drive (FWD) Models

Recreational towing is allowed ONLY if the front wheels are **OFF** the ground. This may be accomplished using a tow dolly (front wheels off the ground) or vehicle trailer (all four wheels off the ground). If using a tow dolly, follow this procedure:

1. Properly secure the dolly to the tow vehicle, following the dolly manufacturer's instructions.
2. Drive the front wheels onto the tow dolly.
3. Apply the parking brake.
4. Place the transmission in PARK.
5. Turn the ignition OFF.
6. Properly secure the front wheels to the dolly, following the dolly manufacturer's instructions.

7. Turn the ignition to the ON/RUN position, but do not start the vehicle.

8. Press and hold the brake pedal.

9. Release the parking brake.

10. Turn the ignition OFF.

11. Release the brake pedal.

##### All-Wheel Drive (AWD) Models

Recreational towing (with all four wheels on the ground, or using a towing dolly) is **NOT ALLOWED**. The only acceptable method for towing this vehicle (behind another vehicle) is on a vehicle trailer with all four wheels **OFF** the ground.

#### CAUTION!

Towing this vehicle with **ANY** of its wheels on the ground can cause severe transmission and/or power transfer unit damage. Damage from improper towing is not covered under the New Vehicle Limited Warranty.

## DRIVING TIPS

### DRIVING ON SLIPPERY SURFACES

Information in this section will aid in safe controlled launches in adverse conditions.

#### Acceleration

Rapid acceleration on snow covered, wet, or other slippery surfaces may cause the driving wheels to pull erratically to the right or left. This phenomenon occurs when there is a difference in the surface traction under the front (driving) wheels.

#### WARNING!

Rapid acceleration on slippery surfaces is dangerous. Unequal traction can cause sudden pulling of the front wheels. You could lose control of the vehicle and possibly have a collision. Accelerate slowly and carefully whenever there is likely to be poor traction (ice, snow, wet, mud, loose sand, etc.).

#### Traction

When driving on wet or slushy roads, it is possible for a wedge of water to build up between the tire and road surface. This is hydroplaning and may cause partial or complete loss of vehicle control and stopping ability. To reduce this possibility, the following precautions should be observed:

- Slow down during rainstorms or when the roads are slushy.
- Slow down if the road has standing water or puddles.
- Replace the tires when tread wear indicators first become visible.

- Keep tires properly inflated.
- Maintain sufficient distance between your vehicle and the vehicle in front of you to avoid a collision in a sudden stop.

### DRIVING THROUGH WATER

Driving through water more than a few inches/centimeters deep will require extra caution to ensure safety and prevent damage to your vehicle.

#### Flowing/Rising Water

#### WARNING!

Do not drive on or across a road or path where water is flowing and/or rising (as in storm run-off). Flowing water can wear away the road or path's surface and cause your vehicle to sink into deeper water. Furthermore, flowing and/or rising water can carry your vehicle away swiftly. Failure to follow this warning may result in injuries that are serious or fatal to you, your passengers, and others around you.

#### Shallow Standing Water

Although your vehicle is capable of driving through shallow standing water, consider the following Warnings and Cautions before doing so.

#### WARNING!

- Driving through standing water limits your vehicle's traction capabilities. Do not exceed 5 mph (8 km/h) when driving through standing water.

*(Continued)*

#### WARNING!

- Driving through standing water limits your vehicle's braking capabilities, which increases stopping distances. Therefore, after driving through standing water, drive slowly and lightly press on the brake pedal several times to dry the brakes.
- Failure to follow these warnings may result in injuries that are serious or fatal to you, your passengers, and others around you.

#### CAUTION!

- Always check the depth of the standing water before driving through it. Never drive through standing water that is deeper than the bottom of the tire rims mounted on the vehicle.
- Determine the condition of the road or the path that is under water and if there are any obstacles in the way before driving through the standing water.
- Do not exceed 5 mph (8 km/h) when driving through standing water. This will minimize wave effects.
- Driving through standing water may cause damage to your vehicle's drivetrain components. Always inspect your vehicle's fluids (i.e., engine oil, transmission, axle, etc.) for signs of contamination (i.e., fluid that is milky or foamy in appearance) after driving through standing water. Do not continue to operate the vehicle if any fluid appears contaminated, as this may result in further damage. Such damage is not covered by the New Vehicle Limited Warranty.
- Getting water inside your vehicle's engine can cause it to lock up and stall out, and cause serious internal damage to the engine. Such damage is not covered by the New Vehicle Limited Warranty.

# MULTIMEDIA

## UCONNECT SYSTEMS

For detailed information about your Uconnect 5 With 7-inch Display or Uconnect 5/5NAV With 10.1-inch Display system, refer to your Uconnect Radio Instruction Manual.

### NOTE:

Uconnect screen images are for illustration purposes only and may not reflect exact software for your vehicle.

## CYBERSECURITY

Depending on applicability, your vehicle may be able to send or receive information from a wired or wireless network. This information allows systems and features in your vehicle to function properly.

Your vehicle may be equipped with certain security features to reduce the risk of unauthorized and unlawful access to vehicle systems and wireless communications. Vehicle software technology continues to evolve over time and FCA US LLC, working with its suppliers, evaluates and takes appropriate steps as needed. As always, if you experience unusual behavior, contact an authorized dealer immediately, ⇨ page 315, or refer to your Uconnect Radio Instruction Manual for additional contact information.

The risk of unauthorized and unlawful access to your vehicle systems may still exist, even if the most recent version of vehicle software (such as Uconnect software) is installed.

### WARNING!

- ONLY insert trusted devices/components into your vehicle. Media of unknown origin could possibly contain malicious software, and if installed in your vehicle, it may increase the possibility for vehicle systems to be breached.
- As always, if you experience unusual vehicle behavior, take your vehicle to an authorized dealer immediately.

### NOTE:

To help further improve user experience, features, stability, etc., and minimize the potential risk of a security breach, vehicle owners should routinely check [www.driveuconnect.com](http://www.driveuconnect.com) (US Residents) or [www.driveuconnect.ca](http://www.driveuconnect.ca) (Canadian Residents) to learn about available Uconnect software updates.

## UCONNECT SETTINGS

The Uconnect system uses a combination of buttons on the touchscreen and buttons on the faceplate located on the center of the instrument panel. These buttons allow you to access and change the Customer Programmable Features. Many features can vary by vehicle.

Buttons on the faceplate are located below and/or beside the Uconnect system in the center of the instrument panel. In addition, there is a SCROLL/ENTER control knob located on the right side. Turn the control knob to scroll through menus and change settings. Push the center of the control knob one or more times to select or change a setting.

Your Uconnect system may also have SCREEN OFF and MUTE buttons on the faceplate.

Push the SCREEN OFF button on the faceplate to turn off the Uconnect screen. Push the button again or tap the screen to turn the screen on.

Press the Back Arrow button to exit out of a Menu or certain option on the Uconnect system.

Push and hold the Power button on the radio's faceplate for a minimum of 15 seconds to reset the radio.

## CUSTOMER PROGRAMMABLE FEATURES

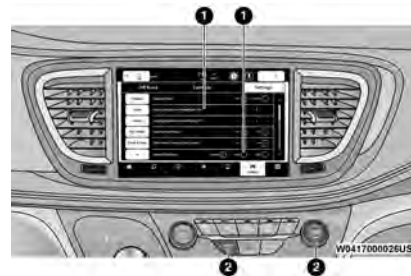

**Uconnect 5/5 NAV With 10.1-inch Display**

- 1 — Uconnect Buttons On The Touchscreen  
2 — Uconnect Buttons On The Faceplate

### For The Uconnect 5 With 7-inch Display and The Uconnect 5/5 NAV With 10.1-inch Display

Press the Vehicle button, then press the Settings tab at the top of the touchscreen. In this menu, the Uconnect system allows you to access all of the available programmable features.

#### NOTE:

- Only one touchscreen area may be selected at a time.
- Depending on the vehicle's options, feature settings may vary.

When making a selection, press the button on the touchscreen to enter the desired menu. Once in the desired menu, press and release the preferred setting option until a check mark appears next to the setting, showing that setting has been selected. Once the setting is complete, press the Vehicle button to exit to the screen. Pressing the Up or Down Arrow button on the right side of the screen will allow you to toggle up or down through the available settings.

## My Profile

When the My Profile button is pressed on the touchscreen, the system displays options related to the vehicle's profiles.

#### NOTE:

Depending on the vehicle's options, feature settings may vary.

Setting Name	Description
Language	This setting will change the language of the Uconnect system and Instrument Cluster Display. The available languages are English, Français, Español, and Italiano.
Display Mode	The setting will adjust the display for the radio to "Auto" or "Manual". "Manual" allows for more customization with the radio display.
Display Brightness Headlights On	This setting will allow you to set the brightness when the headlights are on. To access this setting, Display Mode must be set to "Manual". The "+" setting will increase the brightness; the "-" will decrease the brightness.
Display Brightness Headlights Off	This setting will allow you to set the brightness when the headlights are off. To access this setting, Display Mode must be set to "Manual". The "+" setting will increase the brightness; the "-" will decrease the brightness.
Set Theme	This setting will allow you to change the theme of the radio.
Theme Mode	This setting will allow you to adjust the brightness of your theme. Setting options are "Light", "Dark" and "Auto". Select to show themes in Light or Dark mode. "Auto" changes the theme with the headlights.
Units	This setting changes the "Speed" (MPH or km/h), "Distance" (mi or km), "Fuel Consumption" (MPG [US], MPG [UK], L/100 km, or km/L), "Pressure" (psi, kPa, or bar), "Temperature" (°C or °F), and "Current Consumption" (MPG [US], MPG [UK], L/100 km, or km/L) units of measurement independently.
Touchscreen Beep	This setting will allow you to turn the touchscreen beep on or off.

Setting Name	Description
Show Main Category Bar Labels	This setting will allow the main category bar labels to be shown on or off.
Navigation Next Turn Displayed in Cluster	This setting will display navigation prompts in the Instrument Cluster Display.
Phone Pop-Ups Displayed In Cluster	This setting will display smartphone notifications and messages in the Instrument Cluster Display.
System Text Size	This setting will allow you to change the text on the radio to "Standard", "Large", and "Taller".
Time Format	This setting will allow you to set the time format (AM/PM). Sync Time With GPS must be "Off" for this setting to be available. The "12 hrs" setting will set the time to a 12-hour format. The "24 hrs" setting will set the time to a 24-hour format.
Voice Options	This setting will allow you to change the voice options for the radio to "Male" or "Female".
Wake Up Word	This setting will allow you to turn the voice recognition "Wake Up" word on or off.
Voice Barge-in	This setting will allow you to turn the voice recognition barge-in feature on or off.
Show Command List	This setting will allow the Command List to be shown on or off.
Key Off Power Delay	This setting will keep certain electrical features running after the engine is turned off. When any door is opened, the electronics will deactivate. The available settings are "0 sec", "45 sec", "5 min", and "10 min".
Radio Off With Door	This setting will turn the radio off when the driver or passenger door is opened. The available settings are "On" and "Off".
App Drawer Favoriting Popups	This setting will allow you to favorite app drawer pop-ups with "On" and "Off" options.
App Drawer Unfavoriting Popups	This setting will allow you to unfavorite app drawer pop-ups with "On" and "Off" options.
New Text Message Popups	This setting will allow you to have pop-up notifications for new text messages. This setting options are "On" and "Off".
Missed Calls Message	This setting will allow you to have pop-up notifications for missed calls. This setting options are "On" and "Off".
Navigation Popups	This setting will allow you to have pop-up notifications for Navigation. This setting options are "On" and "Off".
Navigation Settings	This setting will allow you to customize the settings within Navigation Mode.
Auto-On Driver Heated Seat & Steering Wheel	This setting will activate the vehicle's comfort systems and heated seats or heated steering wheel when the vehicle is remote started or ignition is started. The "Off" setting will not activate the comfort systems. The "Remote Start" setting will only activate the comfort systems when using Remote Start. The "All Start" setting will activate the comfort systems whenever the vehicle is started.
Audio Settings	This setting will take you to the audio settings for the vehicle profiles.
Reset App Drawer to Default Order	This setting will reset the app drawer to its factory default layout.
Restore Settings to Default	This setting will return all the previously changed settings to their factory defaults.
More Profile Options	This setting will give access to more profile options.

## Display

After pressing the Display button on the touchscreen, the following settings will be available:

**NOTE:**

Depending on the vehicle's options, feature settings may vary.

Setting Name	Description
<b>Language</b>	This setting will change the language of the Uconnect system and Instrument Cluster Display. The available languages are English, Français, Español, and Italiano.
<b>Display Mode</b>	This setting will allow you to set the brightness manually or have the system set it automatically. The "Auto" setting has the system automatically adjust the display brightness. The "Manual" setting will allow the user to adjust the brightness of the display.
<b>Display Brightness With Headlights ON/Brightness</b>	This setting will allow you to set the brightness when the headlights are on. To access this setting, Display Mode must be set to "Manual". The "+" setting will increase the brightness; the "-" will decrease the brightness.
<b>Display Brightness With Headlights OFF/Brightness</b>	This setting will allow you to set the brightness when the headlights are off. To access this setting, Display Mode must be set to "Manual". The "+" setting will increase the brightness; the "-" will decrease the brightness.
<b>Set Theme</b>	This setting will allow you to change the theme of the radio.
<b>Theme Mode</b>	This setting will allow you to adjust the brightness of your theme. Setting options are "Light", "Dark" and "Auto". Select to show themes in Light or Dark mode. "Auto" changes the theme with the headlights.
<b>Units</b>	This setting changes the "Speed" (MPH or km/h), "Distance" (mi or km), "Fuel Consumption" (MPG [US], MPG [UK], L/100 km, or km/L), "Pressure" (psi, kPa, or bar), "Temperature" (°C or °F), and "Current Consumption" (MPG [US], MPG [UK], L/100 km, or km/L) units of measurement independently.
<b>Touchscreen Beep</b>	This setting will allow you to turn the touchscreen beep on or off.
<b>Show Main Category Bar Labels</b>	This setting will allow the main category bar labels to be shown on or off.
<b>Control Screen Timeout</b>	This setting allows you to set the Control Screen to turn off automatically after five seconds or stay open until manually closed.
<b>Navigation Next Turn Displayed in Cluster</b>	This setting will display navigation prompts in the Instrument Cluster Display.
<b>Phone Pop-Ups Displayed In Cluster</b>	This setting will display smartphone notifications and messages in the Instrument Cluster Display.
<b>Ready To Drive Pop-Ups</b>	This setting will enable the Ready To Drive Pop-Ups in the Instrument Cluster Display.

## Safety & Driving Assistance

After pressing the Safety & Driving Assistance button on the touchscreen, the following settings will be available:

**NOTE:**

Depending on the vehicle's options, feature settings may vary.

Setting Name	Description
<b>Forward Collision Warning Sensitivity — Located In Automatic Emergency Braking Submenu</b>	This setting will change the distance at which the Forward Collision Warning (FCW) alert sounds. The "Medium" setting will have the FCW system signal when an object is in view, and the possibility of a collision is detected. The "Near" setting will have the FCW system signal when the object is closer to the vehicle. The "Far" setting will have the FCW system signal when an object is at a far distance from the vehicle.
<b>Forward Collision Warning — Located In Automatic Emergency Braking Submenu</b>	This setting will turn the Forward Collision Warning system on or off. The "Off" setting will deactivate the FCW system. The "Warning Only" setting will provide only an audible chime when a collision is detected. The "Warning + Active Braking" setting will provide an audible chime and apply some brake pressure when a collision is detected.
<b>Pedestrian Emergency Braking — Located In Automatic Emergency Braking Submenu</b>	This setting will turn the Pedestrian Emergency Braking system "Off" or "Warning + Active Braking".
<b>LaneSense Warning — Located In LaneSense Submenu</b>	This setting will change the distance at which the steering wheel will provide lane departure feedback. The available settings are "Early", "Medium", and "Late".
<b>LaneSense Strength — Located In LaneSense Submenu</b>	This setting will change the strength of the steering wheel feedback during a lane departure. The available settings are "Low", "Medium", and "High".
<b>ParkSense</b>	This setting will change the type of ParkSense alert when a close object is detected. The "Sound Only" setting will provide an audible chime when an object is detected. The "Sound and Display" setting will provide both an audible chime and a visual display when an object is detected.
<b>Front ParkSense Volume</b>	This setting adjusts the volume of the Front ParkSense system. The available settings are "Low", "Medium", and "High".
<b>Rear ParkSense Volume</b>	This setting adjusts the volume of the Rear ParkSense system. The available settings are "Low", "Medium", and "High".
<b>Rear ParkSense Braking Assist</b>	This setting will turn the Rear ParkSense Braking Assist on or off.
<b>Sliding Door Alert</b>	This setting will turn the Sliding Door Alert on and off.
<b>Blind Spot Alert</b>	This setting will change the type of alert provided when an object is detected in a vehicle's blind spot. The "Off" setting will turn off Blind Spot Alert. The "Lights" setting will activate the Blind Spot Alert lights on the outside mirrors. The "Lights + Chime" setting will activate both the lights on the outside mirrors and an audible chime.

Setting Name	Description
Hill Start Assist	This setting will turn the Hill Start Assist system on or off.
Rear Seat Alert	When this setting is turned on and the rear doors are opened while the engine is running, or if the engine is turned on within 10 minutes of the door opening, a message will appear to check the rear seat when the vehicle is powered OFF.

## Clock & Date

After pressing the Clock & Date button on the touchscreen, the following settings will be available:

### NOTE:

Depending on the vehicle's options, feature settings may vary.

Setting Name	Description
Sync Time With GPS	This setting will sync the time to the GPS receiver in the system. The system will control the time via the GPS location.
Set Time	This setting will allow you to manually set the time of your clock.
Time Format	This setting will allow you to set the time format (AM/PM). Sync Time With GPS must be off for this setting to be available. The "12 hrs" setting will set the time to a 12-hour format. The "24 hrs" setting will set the time to a 24-hour format.
Set Date	This setting will allow you to set the date by day, month, and year (DD/MM/YY).
Set Time Hours	This setting will allow you to set the hours. Sync Time With GPS must be off for this setting to be available. The "+" setting will increase the hours. The "-" setting will decrease the hours.
Set Time Minutes	This setting will allow you to set the minutes. Sync Time With GPS must be off for this setting to be available. The "+" setting will increase the minutes. The "-" setting will decrease the minutes.
Show Time in Status Bar	This setting will place the time in the radio's status bar.



## Phone/Bluetooth®

When the Phone/Bluetooth® button is pressed on the touchscreen, the system displays the options related to Bluetooth® connectivity from an external audio device or smart-phone. The list of paired audio devices or smartphones can be accessed from this menu.

**NOTE:**

Depending on the vehicle's options, feature settings may vary.

Setting Name	Description
<b>Device Manager</b>	This setting will open the Device Manager main screen.
<b>Do Not Disturb</b>	This setting will open the Do Not Disturb Settings menu. The settings are "Auto Reply" (both, text, call), "Auto Reply Message" (custom, default), and "Custom Auto Reply Message" (create message).
<b>Do Not Disturb All</b>	This setting will open the "Do Not Disturb All" Settings menu. The available options are "On" and "Off".
<b>Enable Two Active Phones</b>	This setting will enable or disable two active phones with the vehicle. The setting options are "On" and "Off".
<b>Phone Pop-Ups Displayed In Cluster</b>	This setting will activate phone message pop-ups in the Instrument Cluster Display.

5

## Voice — If Equipped

After pressing the Voice button on the touchscreen, the following settings will be available:

**NOTE:**

Depending on the vehicle's options, feature settings may vary.

Setting Name	Description
<b>Voice Options</b>	This setting will allow you to change the voice options for the radio to "Male" or "Female".
<b>Wake Up Word</b>	This setting will allow you to turn the voice recognition "Wake Up" word on or off.
<b>Voice Barge-In</b>	This setting will allow you to turn the voice recognition barge-in feature on or off.
<b>Show Command List</b>	This setting will allow you to turn the Command List on or off. The "Always" setting will always show the Command List. The "With Help" setting will show the Command List and provide a brief description of what the command does. The "Never" setting will turn the Command List off.

## Navigation — If Equipped

When the Navigation button is pressed on the touchscreen, the system displays options related to the vehicle's built-in Navigation system. These settings can change which icons display on the map, how "time to arrival is calculated", and route types.

For more information on Navigation and settings, refer to your Uconnect Radio Instruction Manual.

**NOTE:**

Depending on the vehicle's options, feature settings may vary.

## Camera

When the Camera button is pressed on the touchscreen, the system displays the options related to the vehicle's camera features.

**NOTE:**

Depending on the vehicle's options, feature settings may vary.

Setting Name	Description
Surround View Camera Delay	This setting will add a timed delay to the Surround View Camera when shifting out of REVERSE.
Surround View Camera Guidelines	This setting will turn the Surround View Camera Guidelines on or off.
ParkView Backup Camera Delay	This setting will add a timed delay to the ParkView Backup Camera when shifting out of REVERSE.
ParkView Backup Camera Active Guidelines	This setting will turn the ParkView Backup Camera Active Guidelines on or off.
ParkView Backup Camera Fixed Guidelines	This setting will turn the ParkView Backup Camera Fixed Guidelines on or off.

## Mirrors & Wipers

When the Mirrors & Wipers button is pressed on the touchscreen, the system displays the options related to the vehicle's mirrors and wipers.

### NOTE:

Depending on the vehicle's options, feature settings may vary.

Setting Name	Description
<b>Tilt Side Mirrors In Reverse</b>	This setting will tilt the outside side-view mirrors when the ignition is in the ON/RUN position and the transmission gear selector is in the REVERSE position. The mirrors will move back to their previous position when the transmission is shifted out of REVERSE. The available settings are "On" and "Off".
<b>Auto Folding Side Mirrors</b>	This setting will automatically fold and unfold the side-view mirrors when the vehicle is turned off, the doors are locked, or the key fob button is pushed. The available options are "On" and "Off".
<b>Rain Sensing Auto Wipers</b>	This setting will turn the Rain Sensing Auto Wipers on or off.
<b>Headlights With Wipers</b>	This setting will turn the headlights on when the wipers are activated.

5

## Lights

When the Lights button is pressed on the touchscreen, the system displays the options related to the vehicle's exterior and interior lights.

### NOTE:

- When the "Daytime Running Lights" feature is selected, the daytime running lights can be turned on or off. This feature is only allowed by law in the country of the vehicle purchase.
- Depending on the vehicle's options, feature settings may vary.

Setting Name	Description
<b>Headlight Off Delay</b>	This setting will allow you to set the amount of time it takes for the headlights to shut off after the vehicle is turned off. The available settings are "0 sec", "30 sec", "60 sec", and "90 sec".
<b>Headlight Illumination On Approach</b>	This setting will allow you to set the amount of time it takes for the headlights to shut off after the vehicle is unlocked. The available settings are "0 sec", "30 sec", "60 sec", and "90 sec".
<b>Headlights with Wipers</b>	This setting will turn the headlights on when the wipers are activated.
<b>Daytime Running Lights</b>	This setting will allow you to turn the Daytime Running Lights on or off.

Setting Name	Description
Flash Lights With Lock	This setting will allow you to turn the flashing of the lights when the Lock button is pushed on the key fob on or off.
Auto Dim High Beams	This setting will allow you to turn the Auto Dim High Beams on or off.
Flash Lights With Sliding Door	This setting will flash the lights when the sliding door reverses. The available options are "On" and "Off".

## Brakes

After pressing the Brakes button on the touchscreen, the following settings will be available:

### NOTE:

Depending on the vehicle's options, feature settings may vary.

Setting Name	Description
Auto Park Brake	This setting will turn the Auto Park Brake on or off.
Brake Service	This setting will allow you to retract the brakes for servicing.

## Doors & Locks

After pressing the Doors & Locks button on the touchscreen, the following settings will be available:

Setting Name	Description
Auto Unlock On Exit	This setting will unlock the doors when any of the doors are opened from the inside.
Flash Lights With Lock	This setting will allow you to turn the flashing of the lights when the Lock button is pushed on the key fob on or off.
Sound Horn With Lock	This setting will sound the horn when the Lock button is pushed on the key fob. The "Off" setting will not sound the horn when the Lock button is pushed. The "1st Press" setting will sound the horn when the Lock button is pushed once. The "2nd Press" setting will sound the horn when the Lock button is pushed twice.
Sound Horn With Remote Start	This setting will sound the horn when the remote start is activated from the key fob.
Remote Door Unlock, Door Lock/1st Press Of Key Fob Unlocks	This setting will change how many pushes of the Unlock button on the key fob are needed to unlock all the doors. The "Driver Door" setting will only unlock the driver door on the first push on the Unlock button. The "All Doors" setting will unlock all doors with only one push of the Unlock button.

Setting Name	Description
Passive Entry	This setting will allow you to turn the Passive Entry feature (Keyless Enter 'n Go™) on or off.
Personal Settings Linked To Key Fob	This setting will recall preset radio stations and driver seat position that have been linked to the key fob.
Power Liftgate Alert	This setting will chime an audible alert when the power liftgate is raising or lowering. Selectable options are "On" and "Off".
Sliding Door Alert	This setting will chime an audible alert when the sliding door reverses or sense an obstacle. Selectable options are "On" and "Off".
Flash Lights with Sliding Door	This setting will flash the lights when the sliding door is opening. Selectable options are "On" and "Off".
Hands Free Power Liftgate	This setting will use hands-free technology to automatically open the power liftgate. Selectable options are "On" and "Off".
Hands Free Power Sliding Door	This setting will use hands-free technology to automatically open the power sliding doors. Selectable options are "On" and "Off".

## Seats & Comfort

5

When the Seats & Comfort button is pressed on the touchscreen, the system displays the options related to the vehicle's comfort systems when remote start has been activated or the vehicle has been started.

### NOTE:

Depending on the vehicle's options, feature settings may vary.

Setting Name	Description
Auto-On Driver Heated/Ventilated Seat & Heated Steering Wheel With Vehicle Start	This setting will activate the vehicle's comfort systems and heated seats or heated steering wheel when the vehicle is remote started or ignition is started. The "Off" setting will not activate the comfort systems. The "Remote Start" setting will only activate the comfort systems when using Remote Start. The "All Start" setting will activate the comfort systems whenever the vehicle is started.
Easy Exit Seats	This setting will automatically move the driver seat rearward when the engine is shut off. The available settings are "On" and "Off".
3rd Row Seat Recline Lockout	This setting will activate the 3rd row seat recline lockout. Selectable options are "Off", "Lock On Ignition", and "Always Locked".

## Key Off Options

When the Key Off Options button is pressed on the touchscreen, the system displays the options related to vehicle shutoff. These settings will only activate when the ignition is set to OFF.

**NOTE:**

Depending on the vehicle's options, feature settings may vary.

Setting Name	Description
Easy Exit Seat	This setting adjusts the seats to make exiting the vehicle easier.
Key Off Power Delay	This setting will keep certain electrical features running after the engine is turned off. When any door is opened, the electronics will deactivate. The available settings are "0 sec", "45 sec", "5 min", and "10 min".
Headlight Off Delay	This setting will allow you to set the amount of time the headlights remain on after the vehicle has been turned off. The "+" will increase the amount of time. The "-" will decrease the amount of time.
Radio Off With Door	This setting will turn the radio off when the driver or passenger door is opened. The available settings are "On" and "Off".

## Audio

When the Audio button is pressed on the touchscreen, the system displays options related to the vehicle's sound system. These settings can change the audio location within the vehicle, adjust the bass or treble levels, and auto-play settings from an audio device or smartphone.

**NOTE:**

Depending on the vehicle's options, feature settings may vary.

Setting Name	Description
Balance/Fade	This setting will adjust audio levels from specific speakers in the front/back and left/right of the vehicle. The Speaker icon can be moved to set audio location.
Equalizer	This setting will adjust the "Bass", "Mid", and "Treble" ranges of the audio.

Setting Name	Description
<b>Speed Adjusted Volume</b>	This setting will adjust audio volume as speeds increase. At a higher setting, the volume will increase more as the vehicle speeds up. The available settings are "Off", "1", "2", and "3".
<b>Surround Sound</b>	This setting will turn the Surround Sound system on or off.
<b>AUX Volume Offset</b>	This setting will tune the audio levels from a device connected through the AUX port. The available settings are "+" and "-".
<b>Auto Play</b>	This setting will automatically begin playing audio from a connected device.
<b>Auto On Radio</b>	This setting will automatically turn on when the vehicle is in ON/RUN or will recall whether it was on or off at last ignition OFF. The selectable options are "On", "Off", and "Recall Last".
<b>Volume Adjustment</b>	This setting allows you to adjust the volume levels for features such as Media, Phone, Navigation, and Voice Recognition.

## Notifications

When the Notifications button is pressed on the touchscreen, the system displays the options related to Notifications for the system.

### NOTE:

Depending on the vehicle's options, feature settings may vary.

Setting Name	Description
<b>App Drawer Favoriting Popups</b>	This setting turns the App Favorited pop-up on or off.
<b>App Drawer Unfavoriting Popups</b>	This setting turns the App Unfavorited pop-up on or off.
<b>New Text Message Popups</b>	This setting turns receiving/storing a pop-up for new text messages of any connected phone on or off.
<b>Missed Calls Message</b>	This setting turns receiving/storing a pop-up for missed calls of any connected phone on or off.
<b>Navigation Popups</b>	This setting turns navigation pop-ups on or off.
<b>SiriusXM® Travel Link Weather Alerts</b>	The setting turns receiving notifications for SiriusXM® Travel Link Weather Alerts on or off.

## SiriusXM® Setup

When the SiriusXM® Setup button is pressed on the touchscreen, the system displays options related to SiriusXM® satellite radio. These settings can be used to skip specific radio channels and restart favorite songs from the beginning.

**NOTE:**

- A subscription to SiriusXM® satellite radio is required for these settings to be functional.
- Depending on the vehicle's options, feature settings may vary.

Setting Name	Description
<b>SiriusXM® Account, Profiles &amp; Settings</b>	This setting will allow you to view your SiriusXM® account information, profiles linked to the system, and the various settings you have saved and stored to those profiles.
<b>Block Explicit</b>	This setting will allow you to block explicit content by turning it on or off.

## Accessibility — If Equipped

When pressing the Accessibility button on the touchscreen, the system will display options related to the vehicle's theater system.

**NOTE:**

Depending on the vehicle's options, feature settings may vary.

Setting Name	Description
<b>Accessibility</b>	The Accessibility feature announces a function prior to performing the action selected when using DVD/Blu-ray™ and USB Video functions, when it is activated. For example, when activated, and the Play button is selected, the system will announce "Play button selected", and then once pressed again the Play button will perform its action.
<b>Video Button Readback</b>	This setting will turn the Video Button Readback feature on or off.



## Software Updates

When the Software Updates button is pressed on the touchscreen, the system will display information on updating the Uconnect system's software.

**NOTE:**

Depending on the vehicle's options, feature settings may vary.

Setting Name	Description
Software Downloads over Wi-Fi	This setting will allow software updates to happen over Wi-Fi. Selectable options for the setting are "On" and "Off".

## System Information

When the System Information button is pressed on the touchscreen, the system displays the radio system information.

**NOTE:**

Depending on the vehicle's options, feature settings may vary.

Setting Name	Description
Version Information	When this feature is selected, a Version Information screen will appear, displaying information about the version of your radio.
License Information	When this feature is selected, a License Information screen will appear, displaying the licensing information of your radio.

## Reset

When the Reset button is pressed on the touchscreen, the system displays the options related to resetting the Uconnect system back to its default settings. These settings can clear personal data and reset selected settings from other menus.

**NOTE:**

Depending on the vehicle's options, feature settings may vary.

Setting Name	Description
Notifications Sounds	Turn this setting on or off to hear notification sounds throughout your system.
Restart Radio	This setting will restart the radio.
Reset App Drawer to Default Order	This setting will reset the app drawer to its factory default layout.
Restore Settings to Default	This setting will return all the previously changed settings to their factory defaults.
Clear Personal Data	This setting will display a pop-up that gives you the option to clear all personal data from the system, including Bluetooth® devices and presets.
Reset Wi-Fi Password for Projection	This setting will reset your Wi-Fi password for projection.
Factory Reset	This setting will factory reset the radio. It may cause the radio to restart multiple times and the backup camera, radio, SOS, and several driving assistance features will not be available. Once the system resets, you will need to turn the vehicle off then back on to complete the process.

## STEERING WHEEL AUDIO CONTROLS

The remote sound system controls are located on the rear surface of the steering wheel at the three and nine o'clock positions.

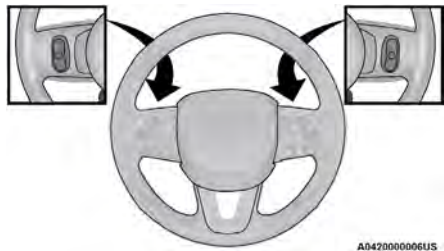

Steering Wheel Audio Controls

The right-hand control is a rocker-type switch with a push button in the center and controls the volume and mode of the sound system. Pushing the top of the rocker switch increases the volume, and pushing the bottom of the rocker switch decreases the volume.

Pushing the right-hand control's center button makes the radio switch between the various modes available (AM/FM/SXM or Media, etc.)

The left-hand control is a rocker-type switch with a push button in the center. The function of the left-hand control is different depending on which mode you are in.

The following describes the left-hand control operation in each mode:

### RADIO OPERATION

Pushing the top of the switch will seek up for the next available station, and pushing the bottom of the switch will seek down for the next available station.

The button located in the center of the left-hand control will tune to the next preset station that you have programmed in the radio preset button.

### MEDIA MODE

Pushing the top of the switch once goes to the next track on the selected media (AUX/USB/Bluetooth®). Pushing the bottom of the switch once goes to the beginning of the current track, or to the beginning of the previous track if it is within eight seconds after the current track begins to play.

## REAR SEAT ENTERTAINMENT (RSE) WITH AMAZON FIRE TV BUILT-IN — IF EQUIPPED

### OVERVIEW

Rear Seat Entertainment with Fire TV built-in is designed to give your family years of enjoyment.

Fire TV lets passengers enjoy a wide variety of content from popular apps (subscriptions may be required). Stream videos, play games, listen to music, get information, and watch downloaded programs all while on the road. Two Voice Remotes with Alexa are included with the system. Press the Microphone button on the Voice

Remote with Alexa to easily find, launch, and control content. Check sports scores, play music, control smart home devices, or see your live camera feeds (compatible smart home device required and sold separately). In addition to streaming and downloaded content, changing the input in Fire TV also enables you to:

- Play your favorite CDs, DVDs, or Blu-ray™ Discs.
- Mirror what's on your phone or tablet to Fire TV via Miracast capable devices.
- Plug and play a variety of standard video games or devices into the HDMI port.
- Listen to audio over wired or wireless headphones (not included, customer will have to provide their own or play audio through in-cabin speakers with Listen In feature in front seat).
- Plug and play a variety of devices into the front seat Video USB port. USB ports located under the rear screens are charge only.
- Watch content individually on each rear display or mirror across both displays to watch together.

#### NOTE:

Vehicle must be in an active and usable cellular range and properly equipped with a Uconnect 5 NAV system and Rear Seat Entertainment with Fire TV package. Streaming requires a Wi-Fi connection and registered Amazon account to run Fire TV in the vehicle. Streaming service subscriptions are not included. Services and features are subject to change or withdrawal at any time, may not be available in all areas and languages, and may require separate subscriptions.

## GETTING STARTED

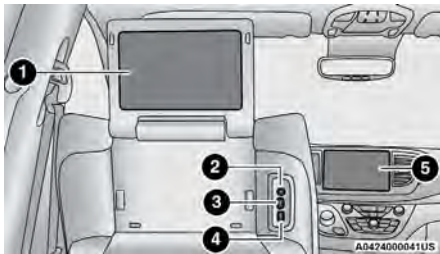

**Rear Seat Entertainment For Uconnect 5/5 NAV**

- 1 — Rear Seat Entertainment (Rear Touchscreen)
- 2 — Headphone Jack
- 3 — HDMI Port
- 4 — USB C Charging Port
- 5 — Uconnect System (Front Touchscreen)

There are three different ways to operate the features of Rear Seat Entertainment with Fire TV built-in:

- Voice Remote with Alexa
- Front radio screen
- Individual rear touchscreens for Rear Seat Entertainment with Fire TV built-in touch on each rear screen

## ACCESSING REAR SEAT ENTERTAINMENT WITH FIRE TV BUILT-IN FROM THE FRONT RADIO SCREEN

You can access your Rear Seat Entertainment with Fire TV built-in system by following these steps:

### Option 1

1. Press the Media button.
2. Press the Rear Seat button icon.

### Option 2

1. Press the Apps button on the bottom of the touchscreen.
2. Press the Uconnect Theater button on the touchscreen. You may need to navigate to different pages in the Apps drawer to find the Uconnect Theater button.

## ACCESSING REAR SEAT ENTERTAINMENT WITH FIRE TV BUILT-IN FROM THE REAR SCREENS

You can access your Rear Seat Entertainment with Fire TV built-in system from the rear screens by just flipping the screens open. Flipping open the rear screens will automatically turn the system on. Tapping either rear screen will also turn on the system for that respective screen.

### NOTE:

When using the rear screens, the system will launch with Fire TV.

## FIRST TIME STARTING UP (USING THE REAR SCREENS)

### Boot-up Screen

When turning on the system for the first time from the rear screens, a boot-up screen will appear on the system displaying the Fire TV logo.

During this boot-up sequence, language options will be available for the system.

### Voice Remote with Alexa Pairing

After the boot-up sequence is complete, the system will then give the option to pair a Voice Remote with Alexa (two are included with the system).

Follow the on-screen instructions for how to pair a Voice Remote with Alexa to the system. Two Voice Remotes with Alexa are included to be paired with each rear screen.

A Voice Remote with Alexa can be paired to each rear screen. It will function with the rear screen it was paired with. The pairing steps will need to be done for each rear screen.

### NOTE:

If the Voice Remote with Alexa pairing fails, on-screen instructions will appear for trying to pair again.

### Connecting to a Network

During the start-up process, the system will need to be connected to a network to function. Multiple network sources can be options for the system.

Some options for a network connection are:

- Wi-Fi Hotspot using a capable smartphone (if activated, it will show as a possible network for the system on the screen).
- Outside connection like a home Wi-Fi network.
- In-vehicle Wi-Fi.

**NOTE:**

When a network is connected to the system for the first time, an over-the-air-software update will take place using the Wi-Fi connection. It is recommended that an unlimited Wi-Fi connection, if available, be used during this update. After this first-time update, updates will only occur when one is available.

**Account Sign-in**

The next step will be the option to sign in to your Amazon account.

There are two options to sign into the system:

- **I already have an Amazon account:** Sign in with an already existing Amazon account
  - **I am new to Amazon:** Create a new Amazon Account
- If “I am new to Amazon” is selected, follow the on-screen steps to set up an Amazon account with the system.

**Parental Controls**

Another feature that will appear during this first time set up is parental controls.

When the parental controls page appears, it will give the options “Enable Parental Controls” and “No Parental Controls”. If “Enable Parental Controls” is selected, follow the on-screen steps to set up parental controls for the system.

**ALEXA VOICE CONTROL**

A feature with Rear Seat Entertainment with Fire TV built-in that enhances your experience is Alexa. It is simple to get started using this feature. Push the Microphone button at the top of the Voice Remote with Alexa to activate Alexa and get started.

**LISTEN VIA VEHICLE SPEAKERS**

A feature within Rear Seat Entertainment with Fire TV built-in is the front radio Listen feature. On the front radio Home screen for Fire TV, select the Listen button in the top right corner on either card for Screen 1 or 2. This will allow you to have either rear screen play audio through all the speakers in the vehicle.

**QUICK MENU**

Accessing the quick menu will give you more options for Fire TV.

To access the quick menu, tap the screen and it will appear. The quick menu is also accessible by pushing the Gear/Settings button on the Voice Remote with Alexa.

Some options of the quick menu are:

- **Power** — This will power the screen off.
- **On-Screen Remote** — This will bring up the on-screen remote to use with the system.
- **Back** — This will let you go back a page.
- **Home** — This will take you to the Home screen.
- **Gear/Settings** — This will let you access certain settings in the system. For more setting options, select “Settings” within the on-screen Gear/Settings menu.
- **Vehicle** — This will bring up the Vehicle menu. From here you can adjust rear climate controls and the Are We There Yet? app.

**PARENTAL CONTROLS (USING THE REAR SCREENS)**

If parental controls were not set during the first time start up of the system, they can be set by following these steps:

1. Push the Gear/Settings button on the Voice Remote with Alexa or tap the screen to access Settings in the “quick menu”.
2. Select the Gear/Settings icon on the screen.
3. Select “Settings” on the screen.
4. While in Settings, select “Preferences”.
5. Select “Parental Controls”; from here you can turn Parental Controls on or off and set up a PIN for the controls using the Voice Remote with Alexa.

**VOICE REMOTE WITH ALEXA PAIRING (USING THE REAR SCREENS)**

If the Voice Remote with Alexa needs to be paired again or a new remote is being paired, follow these procedures:

1. Install batteries into the remote.
2. Tap the screen and Select the Gear/Settings icon on the screen.
3. Select “Settings” on the screen.
4. In Settings, select “Controllers & Bluetooth® Devices”.

- From this menu, select "Add New Remote".
- Follow the on-screen steps for Voice Remote with Alexa pairing.

A long press on the Home button can also re-pair a Voice Remote with Alexa that has become disconnected.

#### NOTE:

Your vehicle is included with two Voice Remotes with Alexa. A Voice Remote with Alexa can be paired to each rear screen. It will function with the rear screen it was paired with. The pairing steps will need to be done for each rear screen.

## MEDIA SOURCES INPUT (USING THE FRONT RADIO AND REAR SCREENS)

### Front Radio Screen

Inputs available within Launch Source under "Inputs" are "Fire TV", "HDMI", "Blu-ray™", "DVD", and "USB".

### Rear Screens

To select inputs on the rear screen, scroll down on the Fire TV Home screen and select your desired input under "Input".

Inputs can also be selected from the Brand tab in the top menu. While in this tab, scroll down to "Inputs" for selection options.

#### NOTE:

The Brand tab naming in the top menu will depend on the naming of the vehicle's brand.

## VOICE REMOTE WITH ALEXA

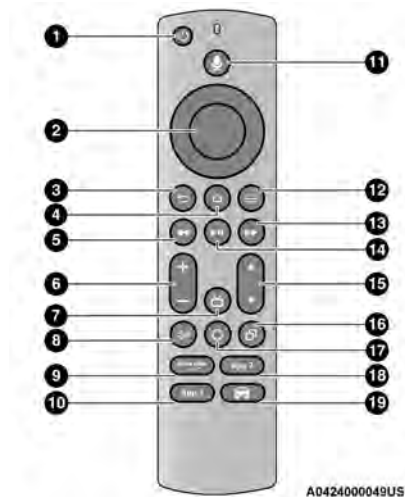

Voice Remote With Alexa

- Power Button** — Turns the screen for the selected channel on or off.
- 5-way Navigation Control** — This control has options by pressing the Circle button Up, Down, Left, or Right to navigate on-screen for selections and pushing the center button to confirm selections.
- Back** — Push to exit out of menus or return to the previous screen.
- Home** — Push to return to the Fire TV Home screen.
- Seek Backward/Rewind Button** — Push and hold to fast rewind through the current audio track or video chapter. Push once to revert back to the previous track.
- Volume** — Push the - button to decrease the volume and + button to increase the volume.
- Channel Guide** — Push to access the channel guide for the system.
- Mute** — Mutes headphone audio.
- Prime Video** — Push to launch Prime Video app.
- App 1** — Push to navigate to App 1.
- Microphone Button** — Push to activate Alexa.
- Menu** — Push to access the Fire TV menu.
- Seek Forward Button** — Push and hold to fast forward through the current audio track or video chapter. Push once to skip to the next track.
- Play/Pause Button ||** — Begin/resume or pause disc play.
- Channel +/-** — Push the up or down arrow button on the Channel button to browse channels available in Fire TV.
- Recent** — Push to access recently viewed content on Fire TV.
- Gear/Settings** — Push to bring up setting options for Fire TV.
- App 2** — Push to launch App 2.
- Vehicle Button** — Push to activate the Vehicle menu.

## Replacing the Voice Remote with Alexa Batteries

Each Voice Remote with Alexa requires two AAA batteries for operation.

### To replace the batteries:

1. Locate the battery compartment on the back of the Voice Remote with Alexa, then slide the battery cover downward.
2. Remove the old batteries and follow battery recycling procedures for your area.
3. Install new batteries, making sure to orient them according to the polarity diagram shown inside the battery compartment.
4. Slide the battery compartment cover back on.

## REAR SEAT ENTERTAINMENT WITH FIRE TV BUILT-IN STREAMING (USING THE FRONT RADIO AND REAR SCREENS)

### Access Using Launch Source

To access Rear Seat Entertainment with Fire TV built-in from the front radio, press the Media tab located on the bottom menu bar. Then select the Rear Seat option located on the top menu bar. Select “Launch Source”, and then under “Inputs” select “Fire TV Home”.

### Access Using Browse Media

Selecting “Browse Media” on the front radio screen will give access to different media within Rear Seat Entertainment with Fire TV built-in.

These options will be in the top menu of “Browse Media” and include:

- **Fire TV** — Selecting “Fire TV” will show streaming options for categories and to select apps. This option will be selectable on the left slider menu in “Browse Media”. While in “Browse Media” under Fire TV, it will display recent activity under “Recent”. This will display recent videos viewed from Fire TV and recent downloads as well.
- **USB Video** — Under “USB Videos”, videos will appear that are options with a USB device connected to Rear Seat Entertainment with Fire TV built-in.
- **USB Music** — Under “USB Music”, music will appear that are options with a USB device connected to Rear Seat Entertainment with Fire TV built-in.

### Access Using the Voice Remote with Alexa and Rear Screens

Rear passengers will be able to access some options for streaming by pressing the “Prime Video”, “App 1”, or “App 2” button on the Voice Remote with Alexa. Selecting one of those buttons on the Voice Remote with Alexa will take you to the home page for that respective streaming service. Turning on either of the rear screens will launch Fire TV. By default, the rear screens will always launch in Fire TV. More streaming options can be selected on the Fire TV home page.

## Fire TV

Fire TV is your source for online streaming with Rear Seat Entertainment with Fire TV built-in.

### NOTE:

A data source needs to be connected to the system for streaming to be accessible. This can be set up when Fire TV is turned on for the first time from the rear screens. Some of these options can be an in-vehicle 4G Wi-Fi hot spot, capable Wi-Fi hot spot from a mobile device, or Wi-Fi from an outside source like a home or a garage.

To access Fire TV on the front screen, select “Launch Source” on the front touchscreen, rear seat screen, and then “Fire TV Home” under “Inputs”.

Viewing from the front radio screen mirrors or controls the Fire TV experience from one of the rear Fire TV displays.

The menu bar for Fire TV will have the options for “Home”, “Find”, “Library”, “Brand”, and “Live”.

Below the menu bar will be streaming options linked to your Prime account like “Prime Video”.

The front radio screen offers some options:

- **Power** — This will turn Fire TV on or off.
- **Screen 1 and Screen 2 Toggle** — This toggles between the Rear Screens (for use with front radio screen only).
- **Collapse** — While viewing on the front radio screen, this will collapse the screen to dashboard view.
- **Source Drawer** — This will open the “Source Drawer” and the source logo will be displayed on the icon.
- **Browse Media** — This will open the “Browse Media” pop-up.

- **Back** — This will let you go back the previous page.
- **Fire TV Home** — This will take you back to the Fire TV home page.
- **Menu** — This will open the Fire TV menu.
- **Remote icon** — This will display the on-screen remote.

**NOTE:**

Front radio screen mirroring and watching can only be done when the vehicle is in PARK. The vehicle must be in an active and usable cellular range and properly equipped with a Uconnect 5 NAV system and Rear Seat Entertainment with Fire TV package. For streaming, a Wi-Fi connection and registered Amazon account are required to run Fire TV in the vehicle. Streaming service subscriptions are not included. Services and features are subject to change or withdrawal at any time, may not be available in all areas and languages, and may require separate subscriptions.

## PLAY A BLU-RAY™ OR DVD — IF EQUIPPED

### Playing a Blu-ray™ or DVD from the Front Radio Screen

1. Insert a Blu-ray™ disc or DVD disc into the disc player with the label facing up.

**NOTE:**

The DVD/Blu-ray™ Disc player is located under the radio controls in the instrument panel.

2. Press the Media button on the bottom menu bar. Then press the Rear Entertainment tab on the top menu bar. Then select “Launch Source” on the radio touchscreen.

3. Select the Blu-ray™ or DVD under inputs in the Launch Source menu
4. To play a Blu-ray™ or DVD disc on both screens simultaneously, select “Launch Source” and then under Inputs, select “View Screen 1 or 2”.



**DVD/Blu-ray™ Disc Player**

- 1 — DVD/Blu-ray™ Player  
2 — USB Port

**NOTE:**

To view video content on the radio screen, bring the vehicle to a stop.

### Playing a Blu-ray™ or DVD from the Rear Screens

1. Insert a Blu-ray™ disc or DVD disc into the disc player with the label facing up.
2. Scroll down on the Fire TV Home screen and select Blu-ray™ or DVD input under “Input”.

## FIRE TV APPS/GAMES (USING THE REAR SCREENS)

Apps and games can be accessed using Rear Seat Entertainment with Fire TV built-in.

To access Apps on the rear screen, turn on the system and select “Find” in the top menu. On the Find page, select “App store®”. Within the App store® you can purchase apps and games. From here you can also select from all the apps and games that have been purchased.

## USING THE VIDEO USB PORT

Plug in a USB drive or mass storage device and play your favorite music or movies.

**NOTE:**

To view USB media on the rear screens, insert a USB drive into the port next to the DVD/Blu-ray™ Disc player. The USB drive port is located under the radio controls in the instrument panel.

On the rear screen you can browse the content of the USB device by going to the USB source in the inputs. Use the search feature to find your media faster.



## PLAY VIDEO GAMES

Connect the video game console to either of the HDMI ports located behind either of the first row seats.

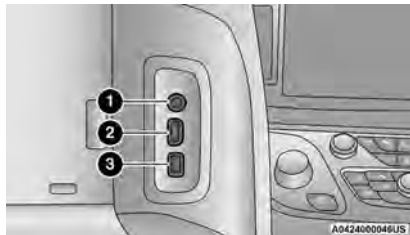

**AUX/HDMI/USB**

- 1 – Headphone Jack (Headphone Output Only)
- 2 – HDMI Port
- 3 – USB Port (Charge Only)

### NOTE:

Certain high-end video games may exceed the power limit of the vehicle's Power Inverter → page 83.

## HEADPHONES OPERATION

Rear Seat Entertainment with Fire TV built-in does not come equipped with headphones. Customers will need to provide their own wireless headphones that can be paired with the system using Bluetooth®. Customers can also use their own wired headphones and plug them into a Headphone Jack located under one of the rear screens.

### Wireless Headphones Pairing

To pair wireless headphones with Rear Seat Entertainment with Fire TV built-in using the rear screens, follow these steps:

1. Push the Gear/Settings button on the Voice Remote with Alexa or tap the screen.
2. Select the Gear/Settings icon on the screen.
3. Select “Settings” on the screen.
4. While in Settings, select “Controllers & Bluetooth® Devices”.
5. Select “Other Bluetooth® Devices” and follow the on-screen steps for pairing.

While multiple headphones can be paired, only one will output audio at a time.



## REAR CLIMATE CONTROLS

The Rear Climate Controls can also be controlled using Rear Seat Entertainment with Fire TV built-in → page 67.

Rear Climate Controls can be accessed by using the Vehicle menu. Tap on either rear screen and select the Vehicle icon or press the Vehicle button on the Voice Remote with Alexa. Then select the Rear Climate Controls option.

Options within Rear Climate Controls include:

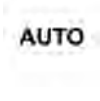
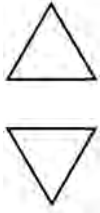
Icon	Description
ON	<b>Climate Control ON Button</b> Press and release this button to turn the Rear Climate Controls on.
OFF	<b>Climate Control OFF Button</b> Press and release this button to turn the Rear Climate Controls off.
SYNC	<b>SYNC Button</b> Pressing this button will sync both sides of the Rear Climate Controls.

Icon	Description
	<p><b>AUTO Button</b> Automatically controls the rear interior cabin temperature by adjusting airflow distribution and amount. Toggling this function will cause the system to switch between Manual mode and Automatic mode.</p>
	<p><b>Rear Passenger Temperature Up and Down Buttons</b> Provides the rear passengers with independent temperature control. Press the button on the touchscreen to increase or decrease the temperature. The temperature will get warmer as you move up toward the red arrow and colder as you move down toward the blue arrow.</p>
<p data-bbox="102 557 236 572"><b>Headliner Mode</b></p> 	<p><b>Headliner Mode</b> Air comes from the outlets in the headliner. Each of these outlets can be individually adjusted to direct the flow of air. Moving the air vanes of the outlets to one side will shut off the airflow.</p>
<p data-bbox="102 721 236 736"><b>Bi-Level Mode</b></p> 	<p><b>Bi-Level Mode</b> Air comes from both the headliner outlets and the floor outlets.</p> <p><b>NOTE:</b> In many temperature positions, the Bi-Level mode is designed to provide cooler air out of the headliner outlets and warmer air from the floor outlets.</p>

Icon	Description
<p data-bbox="102 140 198 156">Floor Mode</p> 	<p data-bbox="278 197 374 213"><b>Floor Mode</b></p> <p data-bbox="278 218 547 234">Air comes from the floor outlets.</p>
<p data-bbox="139 327 228 342"><b>1,2,3, etc.</b></p>	<p data-bbox="278 306 404 322"><b>Blower Control</b></p> <p data-bbox="278 327 1555 366">Blower Control is used to regulate the amount of air forced through the Climate system. There are seven blower speeds available. Adjusting the blower will cause Automatic mode to switch to Manual operation.</p>

## LEGAL & COMPLIANCE

To access Legal and Compliance information about Rear Seat Entertainment with Fire TV built-in from the rear screens, follow these steps:

1. Push the Gear/Settings button on the Voice Remote with Alexa or tap the screen.
2. Select the Gear/Settings icon on the screen.
3. Select "Settings" on the screen.
4. While in the Settings menu, select "My Fire TV" and then "Legal & Compliance".

## RADIO OPERATION AND MOBILE PHONES

Under certain conditions, the mobile phone being on in your vehicle can cause erratic or noisy performance from your radio. This condition may be lessened or eliminated by repositioning the mobile phone within the vehicle. This condition is not harmful to the radio. If your radio performance does not satisfactorily improve from repositioning the mobile phone, it is recommended that the volume be turned down or off during mobile phone operation when not using the Uconnect system.

## REGULATORY AND SAFETY INFORMATION

### US/CANADA

#### Exposure to Radio Frequency Radiation

The radiated output power of the internal wireless radio is far below the FCC and IC radio frequency exposure limits. Nevertheless, the wireless radio will be used in such a manner that the radio is 8 inches (20 cm) or further from the human body.

The internal wireless radio operates within guidelines found in radio frequency safety standards and recommendations, which reflect the consensus of the scientific community.

The radio manufacturer believes the internal wireless radio is safe for use by consumers. The level of energy emitted is far less than the electromagnetic energy emitted by wireless devices such as mobile phones. However, the use of wireless radios may be restricted in some situations or environments, such as aboard air-planes. If you are unsure of restrictions, you are encouraged to ask for authorization before turning on the wireless radio → page 318.

# SAFETY

## SAFETY FEATURES

### ANTI-LOCK BRAKE SYSTEM (ABS)

The ABS provides increased vehicle stability and brake performance under most braking conditions. The system automatically prevents wheel lock and enhances vehicle control during braking.

The ABS performs a self-check cycle to ensure that the ABS is working properly each time the vehicle is started and driven. During this self-check, you may hear a slight clicking sound as well as some related motor noises.

The ABS is activated during braking when the system detects one or more wheels are beginning to lock. Road conditions such as ice, snow, gravel, bumps, railroad tracks, loose debris, or panic stops may increase the likelihood of ABS activation(s).

You also may experience the following normal characteristics when the ABS activates:

- ABS motor noise or clicking sounds (you may continue to hear for a short time after the stop)
- Brake pedal pulsations
- A slight drop of the brake pedal at the end of the stop

The ABS is designed to function with the Original Equipment Manufacturer (OEM) tires. Modification may result in degraded ABS performance.

#### WARNING!

- The ABS contains sophisticated electronic equipment that may be susceptible to interference caused by improperly installed or high output radio transmitting equipment. This interference can cause possible loss of anti-lock braking capability. Installation of such equipment should be performed by qualified professionals.
- Pumping of the Anti-Lock Brakes will diminish their effectiveness and may lead to a collision. Pumping makes the stopping distance longer. Just press firmly on your brake pedal when you need to slow down or stop.
- The ABS cannot prevent the natural laws of physics from acting on the vehicle, nor can it increase braking or steering efficiency beyond that afforded by the condition of the vehicle brakes and tires or the traction afforded.
- The ABS cannot prevent collisions, including those resulting from excessive speed in turns, following another vehicle too closely, or hydroplaning.
- The capabilities of an ABS equipped vehicle must never be exploited in a reckless or dangerous manner that could jeopardize the user's safety or the safety of others.

### Anti-Lock Brake System (ABS) Warning Light

The yellow ABS Warning Light will turn on when the ignition is placed in the ON/RUN mode and may stay on for as long as four seconds.

If the ABS Warning Light remains on or comes on while driving, it indicates that the anti-lock portion of the brake system is not functioning and that service is required. However, the conventional brake system will continue to operate normally if the ABS Warning Light is on.

If the ABS Warning Light is on, the brake system should be serviced as soon as possible to restore the benefits of Anti-Lock Brakes. If the ABS Warning Light does not come on when the ignition is placed in the ON/RUN mode, have the light repaired as soon as possible.

### REGENERATIVE BRAKING SYSTEM (RBS)

The RBS replenishes the vehicle's high voltage battery during deceleration, and is particularly useful in stop-and-go city traffic. The electric motors that propel the vehicle forward can operate as generators when braking. The RBS recharges the high voltage battery under certain braking conditions by recapturing energy that would otherwise be lost while braking. The electric power that is generated goes back into the high voltage battery for later use, for example, when acceleration is desired.

The RBS uses conventional hydraulic friction brakes, regenerative braking, or a combination to slow the vehicle. If the system detects slippery conditions while braking, ONLY friction is used to slow the vehicle. The RBS can result in extended life of the hydraulic service brakes; however, all inspection, scheduled maintenance, and service intervals for the vehicle brakes must be followed.

## AUDIBLE PEDESTRIAN WARNING SYSTEM

Your vehicle is equipped with an Audible Pedestrian Warning system. The Audible Pedestrian Warning system uses distinct sounds to alert pedestrians that your vehicle is approaching. In addition, the module will indicate changes in vehicle speed by varying the relative volume.

The system uses an in-vehicle sound synthesizer with two external speakers. One is located in the under-hood compartment and the other is in the rear of the vehicle. The Audible Pedestrian Warning system is active when the vehicle is not in PARK and is stopped or traveling at lower speeds. Depending on the selected gear (REVERSE, DRIVE, LOW or NEUTRAL), the system activates the corresponding speaker location based on the intended direction of travel.

### NOTE:

The system is active when driving in Electric mode only.

### WARNING!

The Audible Pedestrian Warning system is not intended to avoid a collision. It is always the driver's responsibility to be attentive to the vehicle's distance between other vehicles, people, and objects, and most importantly brake operation to ensure safe operation of the vehicle under all road conditions. Your complete attention is always required while driving to maintain safe control of your vehicle. Failure to follow this warning could result in a collision or serious personal injury.

## ELECTRONIC BRAKE CONTROL (EBC) SYSTEM

Your vehicle is equipped with an advanced Electronic Brake Control (EBC) system. This system includes Anti-Lock Brake System (ABS), Brake Assist System (BAS), Electronic Brake Force Distribution (EBD), Electronic Roll Mitigation (ERM), Electronic Stability Control (ESC), Hill Start Assist (HSA), and Traction Control System (TCS). These systems work together to enhance both vehicle stability and control in various driving conditions.

Your vehicle may also be equipped with Dynamic Steering Torque (DST), Ready Alert Braking (RAB), Rain Brake Support (RBS) and Trailer Sway Control (TSC).

### Brake Assist System (BAS)

The BAS is designed to optimize the vehicle's braking capability during emergency braking maneuvers. The system detects an emergency braking situation by sensing the rate and amount of brake application and then applies optimum pressure to the brakes. This can help reduce braking distances. The BAS complements

the Anti-Lock Brake System (ABS). Applying the brakes very quickly results in the best BAS assistance. To receive the benefit of the system, you must apply continuous braking pressure during the stopping sequence (do not "pump" the brakes). Do not reduce brake pedal pressure unless braking is no longer desired. Once the brake pedal is released, the BAS is deactivated.

### WARNING!

The Brake Assist System (BAS) cannot prevent the natural laws of physics from acting on the vehicle, nor can it increase the traction afforded by prevailing road conditions. BAS cannot prevent collisions, including those resulting from excessive speed in turns, driving on very slippery surfaces, or hydroplaning. The capabilities of a BAS-equipped vehicle must never be exploited in a reckless or dangerous manner, which could jeopardize the user's safety or the safety of others.

## Brake System Warning Light

The red Brake System Warning Light will turn on when the ignition is placed in the ON/RUN mode and may stay on for as long as four seconds.

If the Brake System Warning Light remains on or comes on while driving, it indicates that the brake system is not functioning properly and that immediate service is required. If the Brake System Warning Light does not come on when the ignition is placed in the ON/RUN mode, have the light repaired as soon as possible.

## Dynamic Steering Torque (DST)

DST is a feature of the ESC and Electric Power Steering (EPS) modules that provides torque at the steering wheel for certain driving conditions in which the ESC module is detecting vehicle instability. The torque that the steering wheel receives is only meant to help the driver realize optimal steering behavior in order to reach/maintain vehicle stability. The only notification the driver receives that the feature is active, is the torque applied to the steering wheel.

### NOTE:

The DST feature is only meant to help the driver realize the correct course of action through small torques on the steering wheel, which means the effectiveness of the DST feature is highly dependent on the driver's sensitivity and overall reaction to the applied torque. It is very important to realize that this feature will not steer the vehicle, meaning the driver is still responsible for steering the vehicle.

## Electronic Brake Force Distribution (EBD)

The EBD function manages the distribution of the braking torque between the front and rear axles by limiting braking pressure to the rear axle. This is done to prevent overslip of the rear wheels to avoid vehicle instability, and to prevent the rear axle from entering the Anti-Lock Brake System (ABS) before the front axle.

## Electronic Roll Mitigation (ERM)

ERM anticipates the potential for wheel lift by monitoring the driver's steering wheel input and the speed of the vehicle. When ERM determines that the rate of change of the steering wheel angle and vehicle's speed are sufficient to potentially cause wheel lift, it then applies the appropriate brake and may also reduce engine power to lessen the chance that wheel lift will occur.

ERM can only reduce the chance of wheel lift occurring during severe or evasive driving maneuvers; it cannot prevent wheel lift due to other factors, such as road conditions, leaving the roadway, striking objects or other vehicles.

### WARNING!

Many factors, such as vehicle loading, road conditions and driving conditions, influence the chance that wheel lift or rollover may occur. ERM cannot prevent all wheel lift or rollovers, especially those that involve leaving the roadway or striking objects or other vehicles. The capabilities of an ERM-equipped vehicle must never be exploited in a reckless or dangerous manner which could jeopardize the user's safety or the safety of others.

## Electronic Stability Control (ESC)

ESC enhances directional control and stability of the vehicle under various driving conditions. ESC corrects for oversteering or understeering of the vehicle by applying the brake of the appropriate wheel(s) to assist in counteracting these conditions. Engine power may also be reduced to help the vehicle maintain the desired path.

- Oversteer — when the vehicle is turning more than appropriate for the steering wheel position.
- Understeer — when the vehicle is turning less than appropriate for the steering wheel position.

ESC uses sensors in the vehicle to determine the vehicle path intended by the driver and compares it to the actual path of the vehicle. When the actual path does not match the intended path, ESC applies the brake of the appropriate wheel to assist in counteracting the oversteer or understeer condition.

The ESC Activation/Malfunction Indicator Light located in the instrument cluster will start to flash as soon as the ESC system becomes active. The ESC Activation/Malfunction Indicator Light also flashes when the TCS is active. If the ESC Activation/Malfunction Indicator Light begins to flash during acceleration, ease up on the accelerator and apply as little throttle as possible. Be sure to adapt your speed and driving to the prevailing road conditions.

### WARNING!

- Electronic Stability Control (ESC) cannot prevent the natural laws of physics from acting on the vehicle, nor can it increase the traction afforded by prevailing road conditions. ESC cannot prevent accidents, including those resulting from excessive speed in turns, driving on very slippery surfaces, or hydroplaning. ESC also cannot prevent accidents resulting from loss of vehicle control due to inappropriate driver input for the conditions. Only a safe, attentive, and skillful driver can prevent accidents. The capabilities of an ESC equipped vehicle must never be exploited in a reckless or dangerous manner which could jeopardize the user's safety or the safety of others.
- Vehicle modifications, or failure to properly maintain your vehicle, may change the handling characteristics of your vehicle, and may negatively affect the performance of the ESC system. Changes to the steering system, suspension, braking system, tire type and size or wheel size may adversely affect ESC performance. Improperly inflated and unevenly worn tires may also degrade ESC performance. Any vehicle modification or poor vehicle maintenance that reduces the effectiveness of the ESC system can increase the risk of loss of vehicle control, vehicle rollover, personal injury and death.

## ESC Operating Modes

Depending upon model and mode of operation, the ESC system may have multiple operating modes.

### ESC On

This is the normal operating mode for the ESC. Whenever the vehicle is started, the ESC system will be in this mode. This mode should be used for most driving conditions. Alternate ESC modes should only be used for specific reasons as noted in the following paragraphs.

### Partial Off

This mode may be useful if the vehicle becomes stuck. This mode may modify TCS and ESC thresholds for activation, which allows for more wheel spin than normally allowed.

To enter the "Partial Off" mode, momentarily push the ESC OFF button and the ESC OFF Indicator Light will illuminate. To turn the ESC on again, momentarily push the ESC OFF button and the ESC OFF Indicator Light will turn off.

### NOTE:

When driving with snow chains, or when starting off in deep snow, sand, or gravel, it may be desirable to allow more wheel spin. This can be accomplished by momentarily pushing the ESC OFF button to enter partial mode "Partial Off" mode. Once the situation requiring "Partial Off" mode is overcome, turn ESC back on by momentarily pushing the ESC OFF button. This may be done while the vehicle is in motion.

### WARNING!

- When in "Partial Off" mode, the TCS functionality of ESC (except for the limited slip feature described in the TCS section) has been disabled and the ESC OFF Indicator Light will be illuminated. When in "Partial Off" mode, the engine power reduction feature of TCS is disabled, and the enhanced vehicle stability offered by the ESC system is reduced.
- Trailer Sway Control (TSC) is disabled when the ESC system is in the "Partial Off" mode.

## ESC Activation/Malfunction Indicator Light And ESC OFF Indicator Light



The ESC Activation/Malfunction Indicator Light in the instrument cluster will come on when the ignition is placed in the ON/RUN mode. It should go out with the engine running. If the ESC Activation/Malfunction Indicator Light comes on continuously with the engine running, a malfunction has been detected in the ESC system. If this light remains on after several ignition cycles, and the vehicle has been driven several miles (kilometers) at speeds greater than 30 mph (48 km/h), see an authorized dealer as soon as possible to have the problem diagnosed and corrected.

The ESC Activation/Malfunction Indicator Light starts to flash as soon as the tires lose traction and the ESC system becomes active. The ESC Activation/Malfunction Indicator Light also flashes when TCS is active. If the ESC Activation/Malfunction Indicator Light begins to flash during acceleration, ease up on the accelerator and apply as little throttle as possible. Be sure to adapt your speed and driving to the prevailing road conditions.



The ESC OFF Indicator Light indicates that the Electronic Stability Control (ESC) is in a reduced mode.

### NOTE:

- The ESC Activation/Malfunction Indicator Light and the ESC OFF Indicator Light come on momentarily each time the ignition is placed in the ON/RUN position.
- Each time the ignition is placed in the ON/RUN position, the ESC system will be on even if it was turned off previously.
- The ESC system will make buzzing or clicking sounds when it is active. This is normal; the sounds will stop when ESC becomes inactive following the maneuver that caused the ESC activation.

## Hill Start Assist (HSA)

HSA is designed to mitigate roll back from a complete stop while on an incline. If the driver releases the brake while stopped on an incline, HSA will continue to hold the brake pressure for a short period. If the driver does not apply the throttle before this time expires, the system will release brake pressure and the vehicle will roll down the hill as normal.

The following conditions must be met in order for HSA to activate:

- The feature must be enabled.
- The vehicle must be stopped.
- The parking brake must be off.

- The driver door must be closed.
- The vehicle must be on a sufficient grade.
- The gear selection must match vehicle uphill direction (i.e., vehicle facing uphill is in forward gear; vehicle backing uphill is in REVERSE (R) gear).
- HSA will work in REVERSE gear and all forward gears. The system will not activate if the transmission is in PARK (P) or NEUTRAL (N).

**WARNING!**

There may be situations where the Hill Start Assist (HSA) will not activate and slight rolling may occur, such as on minor hills or with a loaded vehicle, or while pulling a trailer. HSA is not a substitute for active driving involvement. It is always the driver's responsibility to be attentive to distance to other vehicles, people, and objects, and most importantly brake operation to ensure safe operation of the vehicle under all road conditions. Your complete attention is always required while driving to maintain safe control of your vehicle. Failure to follow these warnings can result in a collision or serious personal injury.

**Disabling And Enabling HSA**

This feature can be turned on or turned off. To change the current setting, proceed as follows: ↗ page 169.

**Towing With HSA**

HSA will also provide assistance to mitigate roll back while towing a trailer.

**WARNING!**

- If you use a trailer brake controller with your trailer, the trailer brakes may be activated and deactivated with the brake switch. If so, there may not be enough brake pressure to hold both the vehicle and the trailer on a hill when the brake pedal is released. In order to avoid rolling down an incline while resuming acceleration, manually activate the trailer brake or apply more vehicle brake pressure prior to releasing the brake pedal.
- HSA is not a parking brake. Always apply the parking brake fully when exiting your vehicle. Also, be certain to place the transmission in PARK.
- Failure to follow these warnings can result in a collision or serious personal injury.

**Rain Brake Support (RBS)**

RBS may improve braking performance in wet conditions. It will periodically apply a small amount of brake pressure to remove any water buildup on the front brake rotors. It functions when the windshield wipers are in LO or HI speed. When RBS is active, there is no notification to the driver and no driver interaction is required.

**Ready Alert Braking (RAB)**

RAB may reduce the time required to reach full braking during emergency braking situations. It anticipates when an emergency braking situation may occur by monitoring how fast the throttle is released by the driver. The Electronic Brake Control (EBC) system will prepare the brake system for a panic stop.

**Rear Seat Reminder Alert (RSRA)**

RSRA alerts you through a visual and auditory notification of the possible presence of an object, passenger, or pet in the rear seats if a rear door was opened up to 10 minutes before the ignition was placed in the ON/RUN position. RSRA does not directly detect objects, passengers, or pets in the rear seats. When the previous conditions are met, RSRA displays the message "Check Rear Seat" on the instrument cluster display and sounds an auditory alert upon the driver placing the ignition in the OFF position to exit the vehicle.

To enable or disable RSRA, see ↗ page 169.

**WARNING!**

- Before exiting a vehicle, always come to a complete stop, then shift the automatic transmission into PARK and apply the parking brake.
- Always make sure the keyless ignition node is in the OFF position, key fob is removed from the vehicle and vehicle is locked.
- Never leave children alone in a vehicle, or with access to an unlocked vehicle. Leaving children in a vehicle unattended is dangerous for a number of reasons. A child or others could be seriously or fatally injured. Children should be warned not to touch the parking brake, brake pedal or the gear selector.
- Do not leave children or animals inside parked vehicles in hot weather. Interior heat buildup may cause serious injury or death.



## Traction Control System (TCS)

The TCS monitors the amount of wheel spin of each of the driven wheels. If wheel spin is detected, the TCS may apply brake pressure to the spinning wheel(s) and/or reduce vehicle power to provide enhanced acceleration and stability. A feature of the TCS, Brake Limited Differential (BLD) functions similarly to a limited slip differential and controls the wheel spin across a driven axle. If one wheel on a driven axle is spinning faster than the other, the system will apply the brake of the spinning wheel. This will allow more vehicle torque to be applied to the wheel that is not spinning. BLD may remain enabled even if TCS and the Electronic Stability Control (ESC) are in reduced modes.

## Trailer Sway Control (TSC)

TSC uses sensors in the vehicle to recognize an excessively swaying trailer and will take the appropriate actions to attempt to stop the sway. Note that TSC cannot stop all trailers from swaying. Always use caution when towing a trailer and follow the trailer tongue weight recommendations ↪ page 160.

When TSC is functioning, the ESC Activation/ Malfunction Indicator Light will flash, the engine power may be reduced and you may feel the brakes being applied to individual wheels to attempt to stop the trailer from swaying. TSC is disabled when the ESC system is in the "Partial Off" mode.

### WARNING!

If TSC activates while driving, slow the vehicle down, stop at the nearest safe location, and adjust the trailer load to eliminate trailer sway.

## AUXILIARY DRIVING SYSTEMS

### BLIND SPOT MONITORING (BSM) — IF EQUIPPED

The BSM system uses two radar sensors, located inside the rear fascia/bumper, to detect highway licensable vehicles (automobiles, trucks, motorcycles, etc.) that enter the blind spot zones from the rear/front/side of the vehicle.

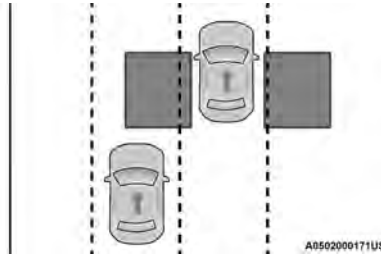

Rear Detection Zones

When the vehicle is started, the BSM Warning Light will momentarily illuminate in both outside rearview mirrors to let the driver know the system is operational. The BSM system sensors operate when the vehicle is in any forward gear and enters standby mode when the vehicle is in PARK (P).

The BSM detection zone covers approximately one lane width on both sides of the vehicle 12 ft (3.7 m). The zone length starts at the outside rearview mirror and extends approximately 10 ft (3 m) beyond the rear fascia/bumper of the vehicle. The BSM system monitors the detection zones on both sides of the vehicle when the vehicle speed reaches approximately 6 mph (10 km/h) or higher and will alert the driver of vehicles in these areas.

#### NOTE:

- The BSM system DOES NOT alert the driver about rapidly approaching vehicles that are outside the detection zones.
- The BSM system detection zone DOES NOT change if your vehicle is towing a trailer. Therefore, visually verify the adjacent lane is clear for both your vehicle and trailer before making a lane change. If the trailer or other object (i.e., bicycle, sports equipment) extends beyond the side of your vehicle, this may result in false detections. The BSM Warning Light may even remain illuminated the entire time the vehicle is in a forward gear.
- The Blind Spot Monitoring (BSM) system may experience dropouts (blinking on and off) of the side mirror warning indicator lights when a motorcycle or any small object remains at the side of the vehicle for extended periods of time (more than a couple of seconds).

The area on the rear fascia/bumper where the radar sensors are located must remain free of snow, ice, and dirt/road contaminants so the BSM system can function properly. Do not block the area of the rear fascia/bumper where the radar sensors are located with foreign objects (bumper stickers, bicycle racks, etc.).

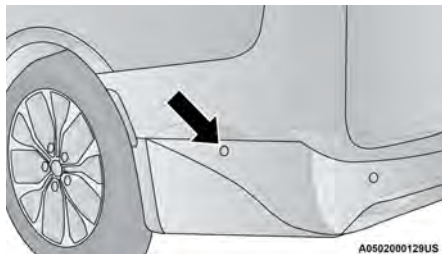

**Sensor Location**

If the system detects degraded performance due to contaminants or foreign objects, a message will warn you of a blocked sensor and the warning indicators in side view mirrors will be on. The warning indicators will remain illuminated until blockage clearing conditions are met. First clear the fascia/bumper area around the sensors of the blockage. After removing the blockage, cycle the ignition from on to off and then back on again to reset the system.

If the blockage message is still present after cycling the ignition and driving in traffic, check again for a blockage.

The BSM system notifies the driver of objects in the detection zones by illuminating the BSM Warning Light located in the outside mirrors in addition to sounding an audible (chime) alert and reducing the radio volume.  page 202.

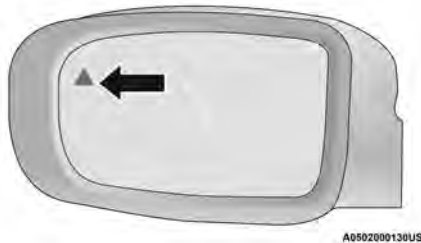

**Warning Light Location**

The BSM system monitors the detection zone from three different entry points (side, rear, front) while driving to see if an alert is necessary. The BSM system will issue an alert during these types of zone entries.

### Entering From The Side

Vehicles that move into your adjacent lanes from either side of the vehicle.

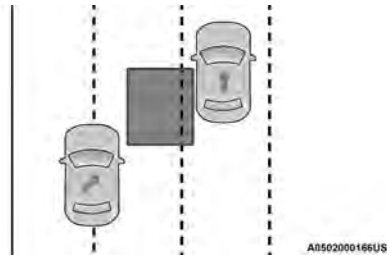

**Side Monitoring**

### Entering From The Rear

Vehicles that come up from behind your vehicle on either side and enter the rear detection zone with a relative speed of less than 30 mph (48 km/h).

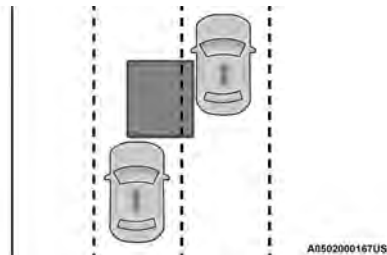

**Rear Monitoring**

### Overtaking Traffic

If you pass another vehicle slowly with a relative speed less than 15 mph (24 km/h) and the vehicle remains in the blind spot for approximately 1.5 seconds, the warning light will be illuminated. If the difference in speed between the two vehicles is greater than 15 mph (24 km/h), the warning light will not illuminate.

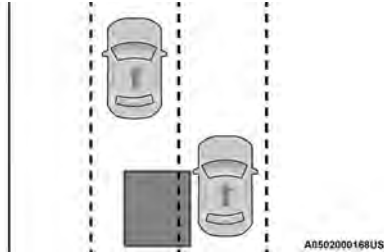

Overtaking/Approaching

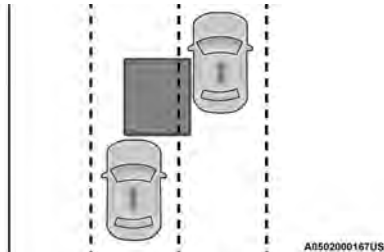

Overtaking/Passing

The BSM system is designed not to issue an alert on stationary objects such as guardrails, posts, walls, foliage, berms, snow banks, car washes, etc. However, occasionally the system may alert on such objects. This is normal operation and your vehicle does not require service.

The BSM system will not alert you of objects that are traveling in the opposite direction of the vehicle in adjacent lanes → page 318.

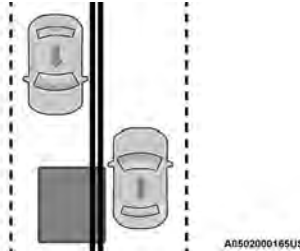

Opposing Traffic

#### WARNING!

The Blind Spot Monitoring system is only an aid to help detect objects in the blind spot zones. The BSM system is not designed to detect pedestrians, bicyclists, or animals. Even if your vehicle is equipped with the BSM system, always check your vehicle's mirrors, glance over your shoulder, and use your turn signal before changing lanes. Failure to do so can result in serious injury or death.

### Rear Cross Path (RCP)

RCP is intended to aid the driver when backing out of parking spaces where their vision of oncoming vehicles may be blocked. Proceed slowly and cautiously out of the parking space until the rear end of the vehicle is exposed. The RCP system will then have a clear view of the cross traffic and if an oncoming vehicle is detected, alert the driver.

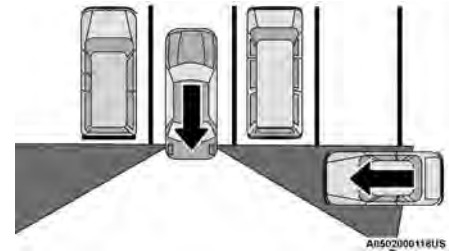

RCP Detection Zones

RCP monitors the rear detection zones on both sides of the vehicle, for objects that are moving toward the side of the vehicle with a minimum speed of approximately 3 mph (5 km/h), to objects moving a maximum of approximately 20 mph (32 km/h), such as in parking lot situations.

**NOTE:**

In a parking lot situation, oncoming vehicles can be blocked by vehicles parked on either side. If the sensors are blocked by other structures or vehicles, the system will not be able to alert the driver. Additionally, if your vehicle is obscured by a flat object on one side the system can false alert on vehicles approaching from the opposite direction.

When RCP is on and the vehicle is in REVERSE (R), the driver is alerted using both the visual and audible alarms, including reducing the radio volume.

**WARNING!**

Rear Cross Path Detection (RCP) is not a back up aid system. It is intended to be used to help a driver detect an oncoming vehicle in a parking lot situation. Drivers must be careful when backing up, even when using RCP. Always check carefully behind your vehicle, look behind you, and be sure to check for pedestrians, animals, other vehicles, obstructions, and blind spots before backing up. Failure to do so can result in serious injury or death.

**Blind Spot Modes**

Three selectable modes of operation are available in the Uconnect system.

**Blind Spot Alert Lights Only — Default Setting**

When operating in Blind Spot Alert mode, the BSM system will provide a visual alert in the appropriate side view mirror based on a detected object. However, when the system is operating in Rear Cross Path (RCP) mode, the system will respond with both visual and audible alerts when a detected object is present. Whenever an audible alert is requested, the radio is muted.

**Blind Spot Alert Lights/Chime**

When operating in Blind Spot Alert Lights/Chime mode, the BSM system will provide a visual alert in the appropriate side view mirror based on a detected object. If the turn signal is then activated, and it corresponds to an alert present on that side of the vehicle, an audible chime will also be sounded. Whenever a turn signal and detected object are present on the same side at the same time, both the visual and audible alerts will be issued. In addition to the audible alert the radio (if on) will also be muted.

**NOTE:**

Whenever an audible alert is requested by the BSM system, the radio is also muted.

When the system is in RCP, the system shall respond with both visual and audible alerts when a detected object is present. Whenever an audible alert is requested, the radio is also muted. Turn/hazard signal status is ignored; the RCP state always requests the chime.

**Blind Spot Alert Off**

When the BSM system is turned off there will be no visual or audible alerts from either the BSM or RCP systems.

**NOTE:**

The BSM system will store the current operating mode when the vehicle is shut off. Each time the vehicle is started the previously stored mode will be recalled and used.

**FORWARD COLLISION WARNING (FCW) WITH MITIGATION — IF EQUIPPED**

FCW with Mitigation provides the driver with audible warnings, visual warnings (within the instrument cluster display), and may apply a brake jerk to warn the driver when it detects a potential frontal collision. The warnings and limited braking are intended to provide the driver with enough time to react, avoid or mitigate the potential collision.

**NOTE:**

FCW monitors the information from the forward looking sensors as well as the Electronic Brake Controller (EBC), to calculate the probability of a forward collision. When the system determines that a forward collision is probable, the driver will be provided with audible and visual warnings and may provide a brake jerk warning.

If the driver does not take action based upon these progressive warnings, then the system will provide a limited level of active braking to help slow the vehicle and mitigate the potential forward collision. If the driver reacts to the warnings by braking and the system determines that the driver intends to avoid the collision by braking but has not applied sufficient brake force, the system will compensate and provide additional brake force as required.

If a FCW with Mitigation event begins at a speed below 37 mph (60 km/h), the system may provide the maximum braking possible to mitigate the potential forward collision. If the Forward Collision Warning with Mitigation event stops the vehicle completely, the system will hold the vehicle at standstill for two seconds and then release the brakes. If a pedestrian is encountered in the path at the same speed threshold, the system will attempt to bring the vehicle to a stop.



FCW Message

When the system determines a collision with the vehicle in front of you is no longer probable, the warning message will be deactivated ↪ page 318.

**NOTE:**

- The minimum speed for FCW activation is 1 mph (2 km/h).
- The FCW alerts may be triggered on objects other than vehicles such as guardrails or sign posts based on the course prediction. This is expected and is a part of normal FCW activation and functionality.
- It is unsafe to test the FCW system. To prevent such misuse of the system, after four Active Braking events within a key cycle, the Active Braking portion of FCW will be deactivated until the next key cycle.
- The FCW system is intended for on-road use only. If the vehicle is taken off-road, the FCW system should be deactivated to prevent unnecessary warnings to the surroundings.

**WARNING!**

Forward Collision Warning (FCW) is not intended to avoid a collision on its own, nor can FCW detect every type of potential collision. The driver has the responsibility to avoid a collision by controlling the vehicle via braking and steering. Failure to follow this warning could lead to serious injury or death.

**Turning FCW On Or Off**

The Forward Collision menu setting is located in the Uconnect settings.

**NOTE:**

The default status of FCW is "on", this allows the system to warn you of a possible collision with the vehicle in front of you.

Changing the FCW status to "off" deactivates the system, so no warning or active braking will be available in case of a possible collision.

**NOTE:**

The FCW system state is kept in memory from one key cycle to the next. If the system is turned off, it will remain off when the vehicle is restarted.

**FCW Braking Status And Sensitivity**

The FCW Sensitivity and Active Braking status are programmable through the Uconnect system ↪ page 169.

The default sensitivity of FCW is the "Medium" setting and the system status is "Warning & Braking". This allows the system to warn the driver of a possible collision with the vehicle in front using audible/visual warnings and it applies autonomous braking.

By changing the FCW status setting to "Far", the system provides possible collision warnings on objects farther away. This results in earlier warnings and provides the most reaction time to avoid possible collisions.

**NOTE:**

The "Far" setting may result in a greater number of FCW possible collision warnings experienced.

By changing the FCW status setting to "Near", the system provides possible collision warnings on objects closer to the vehicle. This results in later warnings and provides less reaction time than the "Far" and "Medium" settings, which allows for a more dynamic driving experience.

**NOTE:**

The "Near" setting may result in a lesser number of FCW possible collision warnings experienced.

**NOTE:**

- Changing the FCW status to "Only Warning" prevents the system from providing limited active braking, or additional brake support if the driver is not braking adequately in the event of a potential frontal collision, but maintains the audible and visual warnings.
- Changing the FCW status to "Off" prevents the system from providing autonomous braking, or additional brake support if the driver is not braking adequately in the event of a potential frontal collision.
- The system will retain the last setting selected by the driver after ignition shut down.

- FCW may not react to irrelevant objects such as overhead objects, ground reflections, objects not in the path of the vehicle, stationary objects that are far away, oncoming traffic, or leading vehicles with the same or higher rates of speed.
- FCW will be disabled like ACC, with the unavailable screens.

### FCW Limited Warning

If the instrument cluster displays “ACC/FCW Limited Functionality”, “FCW Limited Functionality”, “ACC/FCW Limited Functionality Clean Front Windshield”, or “FCW Limited Functionality Clean Front Windshield” momentarily, there may be a condition that limits FCW functionality. Although the vehicle is still drivable under normal conditions, the active braking may not be fully available. Once the condition that limited the system performance is no longer present, the system will return to its full performance state. If the problem persists, see an authorized dealer.

### Service FCW Warning

If the system turns off, and the instrument cluster displays:

- ACC/FCW Unavailable Service Required
- FCW Unavailable Service Required

This indicates there is an internal system fault. Although the vehicle is still drivable under normal conditions, have the system checked by an authorized dealer.

### Pedestrian Emergency Braking (PEB) — If Equipped

PEB is a subsystem of the FCW system which provides the driver with audible and visual warnings in the instrument cluster display, and may apply automatic braking when it detects a potential frontal collision with a pedestrian/cyclist.



PEB Message

If a PEB event begins at a speed below 37 mph (60 km/h), the system may provide braking to mitigate the potential collision with a pedestrian/cyclist. If the PEB event stops the vehicle completely, the system will hold the vehicle at a standstill for two seconds and then release the brakes. When the system determines a collision with the pedestrian/cyclist in front of you is no longer probable, the warning message will be deactivated.

The minimum speed for PEB activation is 3 mph (5 km/h).

#### WARNING!

Pedestrian Emergency Braking (PEB) is not intended to avoid a collision on its own, nor can PEB detect every type of potential collision with a pedestrian/cyclist. The driver has the responsibility to avoid a collision by controlling the vehicle via braking and steering. Failure to follow this warning could lead to serious injury or death.

#### Turning PEB On Or Off

##### NOTE:

The default status of PEB is “On.” This allows the system to warn you of a possible frontal collision with the pedestrian/cyclist.

The PEB button is located in the Uconnect display in the Controls settings  page 169.

To turn the PEB system off, push the Pedestrian Emergency Braking OFF button.

To turn the PEB system back on, push the Warning Active Braking button.

Changing the PEB status to “Off” deactivates the system, so no warning or active braking will be available in case of a possible frontal collision with the pedestrian/cyclist.

##### NOTE:

The PEB system will NOT retain the last setting selected by the driver after ignition shut down. The system will reset to the default setting when the vehicle is restarted.

## TIRE PRESSURE MONITORING SYSTEM (TPMS)

The Tire Pressure Monitoring System (TPMS) will warn the driver of a low tire pressure based on the vehicle recommended cold placard pressure.

### NOTE:

The TPMS Warning Light will illuminate in the instrument cluster and a chime will sound when tire pressure is low in one or more of the four active road tires. In addition, the instrument cluster will display a graphic showing the pressure values of each tire with the low tire pressure values in a different color, or the Uconnect radio will display a TPMS message. When this occurs you must increase the tire pressure to the recommended cold placard pressure in order for the TPMS Warning Light to turn off.

The tire pressure will vary with temperature by approximately 1 psi (7 kPa) for every 12°F (6.5°C). This means that when the outside temperature decreases, the tire pressure will decrease. Tire pressure should always be set based on cold inflation tire pressure. This is defined as the tire pressure after the vehicle has not been driven for at least three hours, or driven less than 1 mile (1.6 km) after a three hour period. The cold tire inflation pressure must not exceed the maximum inflation pressure molded into the tire sidewall. The tire pressure will also increase as the vehicle is driven. This is normal and there should be no adjustment for this increased pressure.

See  page 291 for information on how to properly inflate the vehicle's tires.

The TPMS will warn the driver of a low tire pressure if the tire pressure falls below the low-pressure warning limit for any reason, including low temperature effects and natural pressure loss through the tire.

The TPMS will continue to warn the driver of low tire pressure as long as the condition exists, and will not turn off until the tire pressure is at or above the recommended cold placard pressure. Once the low tire pressure warning (TPMS Warning Light) illuminates, you must increase the tire pressure to the recommended cold placard pressure in order for the TPMS Warning Light to turn off.

The system will automatically update and the TPMS Warning Light will turn off once the system receives the updated tire pressures. The vehicle may need to be driven for up to 20 minutes above 15 mph (24 km/h) in order for the TPMS to receive this information.

For example, your vehicle may have a recommended cold (parked for more than three hours) placard pressure of 33 psi (227 kPa). If the ambient temperature is 68°F (20°C) and the measured tire pressure is 28 psi (193 kPa), a temperature drop to 20°F (-7°C) will decrease the tire pressure to approximately 24 psi (165 kPa). This tire pressure is low enough to turn on the TPMS Warning Light. Driving the vehicle may cause the tire pressure to rise to approximately 28 psi (193 kPa), but the TPMS Warning Light will still be on. In this situation, the TPMS Warning Light will turn off only after the tires are inflated to the vehicle's recommended cold placard pressure value  page 318.

### NOTE:

When filling warm tires, the tire pressure may need to be increased up to an additional 4 psi (28 kPa) above the recommended cold placard pressure in order to turn the TPMS Warning Light off.

### CAUTION!

- The TPMS has been optimized for the original equipment tires and wheels. TPMS pressures and warning have been established for the tire size equipped on your vehicle. Undesirable system operation or sensor damage may result when using replacement equipment that is not of the same size, type, and/or style. The TPMS sensor is not designed for use on aftermarket wheels and may contribute to a poor overall system performance or sensor damage. Customers are encouraged to use Original Equipment Manufacturer (OEM) wheels to ensure proper TPMS feature operation.
- Using aftermarket tire sealants may cause the Tire Pressure Monitoring System (TPMS) sensor to become inoperable. After using an aftermarket tire sealant it is recommended that you take your vehicle to an authorized dealer to have your sensor function checked.
- After inspecting or adjusting the tire pressure always reinstall the valve stem cap. This will prevent moisture and dirt from entering the valve stem, which could damage the TPMS sensor.

### NOTE:

- The TPMS is not intended to replace normal tire care and maintenance, or to provide warning of a tire failure or condition.
- The TPMS should not be used as a tire pressure gauge while adjusting your tire pressure.

- Driving on a significantly underinflated tire causes the tire to overheat and can lead to tire failure. Underinflation also reduces fuel efficiency and tire tread life, and may affect the vehicle's handling and stopping ability.
- The TPMS is not a substitute for proper tire maintenance, and it is the driver's responsibility to maintain correct tire pressure using an accurate tire pressure gauge, even if underinflation has not reached the level to trigger illumination of the TPMS Warning Light.
- Seasonal temperature changes will affect tire pressure, and the TPMS will monitor the actual tire pressure in the tire.

## Premium System

The Tire Pressure Monitoring System (TPMS) uses wireless technology with wheel rim mounted electronic sensors to monitor tire pressure levels. Sensors, mounted to each wheel as part of the valve stem, transmit tire pressure readings to the receiver module.

### NOTE:

It is particularly important for you to check the tire pressure in all of the tires on your vehicle monthly and to maintain the proper pressure.

The TPMS consists of the following components:

- Receiver module
- Four Tire Pressure Monitoring System sensors
- Various Tire Pressure Monitoring System messages, which display in the instrument cluster
- Tire Pressure Monitoring System Warning Light

## SERVICE TPMS WARNING

When a system fault is detected, the Tire Pressure Monitoring System (TPMS) Warning Light will flash on and off for 75 seconds and then remain on solid. The system fault will also sound a chime. In addition, the instrument cluster will display a "SERVICE TPM SYSTEM" message for a minimum of five seconds and then display dashes (-) in place of the pressure value to indicate which sensor is not being received.

If the ignition is cycled, this sequence will repeat, providing the system fault still exists. If the system fault no longer exists, the TPMS Warning Light will no longer flash, and the "SERVICE TPM SYSTEM" message will no longer display, and a pressure value will display in place of the dashes. A system fault can occur due to any of the following:

- Jamming due to electronic devices or driving next to facilities emitting the same radio frequencies as the TPMS sensors
- Installing some form of aftermarket window tinting that affects radio wave signals
- Lots of snow or ice around the wheels or wheel housings
- Using tire chains on the vehicle
- Using wheels/tires not equipped with TPMS sensors

### Vehicles With Compact Spare — If Equipped

1. The compact spare tire does not have a Tire Pressure Monitoring System sensor. Therefore, the TPMS will not monitor the pressure in the compact spare tire.
2. If you install the compact spare tire in place of a road tire that has a pressure below the low-pressure warning limit, upon the next ignition cycle, the TPMS Warning Light will remain on and a chime will sound. In addition, the graphic in the instrument cluster will still display a different color pressure value.

3. After driving the vehicle for up to 20 minutes above 15 mph (24 km/h), the TPMS Warning Light will flash on and off for 75 seconds and then remain on solid. In addition, the instrument cluster will display a "SERVICE TPM SYSTEM" message for five seconds and then display dashes (-) in place of the pressure value.
4. For each subsequent ignition cycle, a chime will sound, the TPMS Warning Light will flash on and off for 75 seconds and then remain on solid, and the instrument cluster will display a "SERVICE TPM SYSTEM" message for five seconds and then display dashes (-) in place of the pressure value.
5. Once you repair or replace the original road tire and reinstall it on the vehicle in place of the compact spare, the TPMS will update automatically. In addition, the TPMS Warning Light will turn off and the graphic in the instrument cluster will display a new pressure value instead of dashes (-), as long as no tire pressure is below the low-pressure warning limit in any of the four active road tires. The vehicle may need to be driven for up to 20 minutes above 15 mph (24 km/h) in order for the TPMS to receive this information.



## TIRE PRESSURE MONITORING SYSTEM LOW PRESSURE WARNINGS



The TPMS Warning Light will illuminate in the instrument cluster and a chime will sound when tire pressure is low in one or more of the four active road tires. In addition, the instrument cluster will display an "Inflate to XX" message and a graphic showing the pressure values of each tire with the low tire pressure values in a different color.

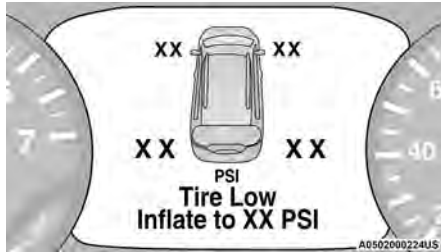

**Tire Pressure Monitoring System**

Should this occur, you should stop as soon as possible and inflate the tires with low pressure (those in a different color in the instrument cluster graphic) to the vehicle's recommended cold placard pressure value as shown in the "Inflate to XX" message. Once the system receives the updated tire pressures, the system will automatically update, the pressure values in the graphic display in the instrument cluster will return to their original color, and the TPMS Warning Light will turn off. The vehicle may need to be driven for up to 20 minutes above 15 mph (24 km/h) in order for the TPMS to receive this information.

## TPMS DEACTIVATION — IF EQUIPPED

The Tire Pressure Monitoring System (TPMS) can be deactivated if replacing all four wheel and tire assemblies (road tires) with wheel and tire assemblies that do not have TPMS sensors, such as when installing winter wheel and tire assemblies on your vehicle.

To deactivate the TPMS, first, replace all four wheel and tire assemblies (road tires) with tires not equipped with Tire Pressure Monitoring System (TPMS) sensors. Then, drive the vehicle for 20 minutes above 15 mph (24 km/h). The TPMS will chime, the TPMS Warning Light will flash on and off for 75 seconds and then remain on. The instrument cluster will display the "SERVICE TPM SYSTEM" message and then display dashes (–) in place of the pressure values.

Beginning with the next ignition cycle, the TPMS will no longer chime or display the "SERVICE TPM SYSTEM" message in the instrument cluster but dashes (–) will remain in place of the pressure values.

To reactivate the TPMS, replace all four wheel and tire assemblies (road tires) with tires equipped with TPMS sensors. Then, drive the vehicle for up to 20 minutes above 15 mph (24 km/h). The TPMS will chime, the TPMS Warning Light will flash on and off for 75 seconds and then turn off. The instrument cluster will display the "SERVICE TPM SYSTEM" message and then display pressure values in place of the dashes. On the next ignition cycle the "SERVICE TPM SYSTEM" message will no longer be displayed as long as no system fault exists.

## OCCUPANT RESTRAINT SYSTEMS

Some of the most important safety features in your vehicle are the restraint systems:

### OCCUPANT RESTRAINT SYSTEMS FEATURES

- Seat Belt Systems
- Supplemental Restraint Systems (SRS) Air Bags
- Child Restraints

Some of the safety features described in this section may be standard equipment on some models, or may be optional equipment on others. If you are not sure, ask an authorized dealer.

### IMPORTANT SAFETY PRECAUTIONS

Please pay close attention to the information in this section. It tells you how to use your restraint system properly, to keep you and your passengers as safe as possible.

Here are some simple steps you can take to minimize the risk of harm from a deploying air bag:

1. Children 12 years old and under should always ride buckled up in the rear seat of a vehicle with a rear seat.
2. A child who is not big enough to wear the vehicle seat belt properly must be secured in the appropriate child restraint or belt-positioning booster seat in a rear seating position → page 225.
3. If a child from 2 to 12 years old (not in a rear-facing child restraint) must ride in the front passenger seat, move the seat as far back as possible and use the proper child restraint → page 225.

4. Never allow children to slide the shoulder belt behind them or under their arm.
5. You should read the instructions provided with your child restraint to make sure that you are using it properly.
6. All occupants should always wear their lap and shoulder belts properly.
7. The driver and front passenger seats should be moved back as far as practical to allow the front air bags room to inflate.
8. Do not lean against the door or window. If your vehicle has side air bags, and deployment occurs, the side air bags will inflate forcefully into the space between occupants and the door and occupants could be injured.
9. If the air bag system in this vehicle needs to be modified to accommodate a disabled person, see  page 315 for customer service contact information.

**WARNING!**

- Never place a rear-facing child restraint in front of an air bag. A deploying passenger front air bag can cause death or serious injury to a child 12 years or younger, including a child in a rear-facing child restraint.
- Never install a rear-facing child restraint in the front seat of a vehicle. Only use a rear-facing child restraint in the rear seat. If the vehicle does not have a rear seat, do not transport a rear-facing child restraint in that vehicle.

## SEAT BELT SYSTEMS

Buckle up even though you are an excellent driver, even on short trips. Someone on the road may be a poor driver and could cause a collision that includes you. This can happen far away from home or on your own street.

Research has shown that seat belts save lives, and they can reduce the seriousness of injuries in a collision. Some of the worst injuries happen when people are thrown from the vehicle. Seat belts reduce the possibility of ejection and the risk of injury caused by striking the inside of the vehicle. Everyone in a motor vehicle should be belted at all times.

### Enhanced Seat Belt Use Reminder System (BeltAlert)

#### Driver And Passenger BeltAlert — If Equipped



BeltAlert is a feature intended to remind the driver and outboard front seat passenger (if equipped with outboard front passenger seat BeltAlert) to buckle their seat belts. The BeltAlert feature is active whenever the ignition switch is in the START or ON/RUN position.

#### Initial Indication

If the driver is unbuckled when the ignition switch is first in the START or ON/RUN position, a chime will signal for a few seconds. If the driver or outboard front seat passenger (if equipped with outboard front passenger seat BeltAlert) is unbuckled when the ignition switch is first in the START or ON/RUN position the Seat Belt Reminder Light will turn on and remain on until both outboard front seat belts are buckled. The outboard front passenger seat BeltAlert is not active when an outboard front passenger seat is unoccupied.

#### BeltAlert Warning Sequence

The BeltAlert warning sequence is activated when the vehicle is moving above a specified vehicle speed range and the driver or outboard front seat passenger is unbuckled (if equipped with outboard front passenger seat BeltAlert) (the outboard front passenger seat BeltAlert is not active when the outboard front passenger seat is unoccupied). The BeltAlert warning sequence starts by blinking the Seat Belt Reminder Light and sounding an intermittent chime. Once the BeltAlert warning sequence has completed, the Seat Belt Reminder Light will remain on until the seat belts are buckled. The BeltAlert warning sequence may repeat based on vehicle speed until the driver and occupied outboard front seat passenger seat belts are buckled. The driver should instruct all occupants to buckle their seat belts.

#### Change of Status

If the driver or outboard front seat passenger (if equipped with outboard front passenger seat BeltAlert) unbuckles their seat belt while the vehicle is traveling, the BeltAlert warning sequence will begin until the seat belts are buckled again.

The outboard front passenger seat BeltAlert is not active when the outboard front passenger seat is unoccupied. BeltAlert may be triggered when an animal or other items are placed on the outboard front passenger seat or when the seat is folded flat (if equipped). It is recommended that pets be restrained in the rear seat (if equipped) in pet harnesses or pet carriers that are secured by seat belts, and cargo is properly stowed.

BeltAlert can be activated or deactivated by an authorized dealer. FCA US LLC does not recommend deactivating BeltAlert.

**NOTE:**

If BeltAlert has been deactivated and the driver or outboard front seat passenger (if equipped with outboard front passenger seat BeltAlert) is unbuckled the Seat Belt Reminder Light will turn on and remain on until the driver and outboard front seat passenger seat belts are buckled.

**Lap/Shoulder Belts**

All seating positions in your vehicle are equipped with lap/shoulder belts.

The seat belt webbing retractor will lock only during very sudden stops or collisions. This feature allows the shoulder part of the seat belt to move freely with you under normal conditions. However, in a collision the seat belt will lock and reduce your risk of striking the inside of the vehicle or being thrown out of the vehicle.

**WARNING!**

- Relying on the air bags alone could lead to more severe injuries in a collision. The air bags work with your seat belt to restrain you properly. In some collisions, the air bags won't deploy at all. Always wear your seat belt even though you have air bags.
- In a collision, you and your passengers can suffer much greater injuries if you are not properly buckled up. You can strike the interior of your vehicle or other passengers, or you can be thrown out of the vehicle. Always be sure you and others in your vehicle are buckled up properly.
- It is dangerous to ride in a cargo area, inside or outside of a vehicle. In a collision, people riding in these areas are more likely to be seriously injured or killed.

*(Continued)***WARNING!**

- Do not allow people to ride in any area of your vehicle that is not equipped with seats and seat belts.
- Be sure everyone in your vehicle is in a seat and using a seat belt properly. Occupants, including the driver, should always wear their seat belts whether or not an air bag is also provided at their seating position to minimize the risk of severe injury or death in the event of a crash.
- Wearing your seat belt incorrectly could make your injuries in a collision much worse. You might suffer internal injuries, or you could even slide out of the seat belt. Follow these instructions to wear your seat belt safely and to keep your passengers safe, too.
- Two people should never be belted into a single seat belt. People belted together can crash into one another in a collision, hurting one another badly. Never use a lap/shoulder belt or a lap belt for more than one person, no matter what their size.

**WARNING!**

- A lap belt worn too high can increase the risk of injury in a collision. The seat belt forces won't be at the strong hip and pelvic bones, but across your abdomen. Always wear the lap part of your seat belt as low as possible and keep it snug.
- A twisted seat belt may not protect you properly. In a collision, it could even cut into you. Be sure the seat belt is flat against your body, without twists. If you can't straighten a seat belt in your vehicle, take it to an authorized dealer immediately and have it fixed.

*(Continued)***WARNING!**

- A seat belt that is buckled into the wrong buckle will not protect you properly. The lap portion could ride too high on your body, possibly causing internal injuries. Always buckle your seat belt into the buckle nearest you.
- A seat belt that is too loose will not protect you properly. In a sudden stop, you could move too far forward, increasing the possibility of injury. Wear your seat belt snugly.
- A seat belt that is worn under your arm is dangerous. Your body could strike the inside surfaces of the vehicle in a collision, increasing head and neck injury. A seat belt worn under the arm can cause internal injuries. Ribs aren't as strong as shoulder bones. Wear the seat belt over your shoulder so your strongest bones will take the force in a collision.
- A shoulder belt placed behind you will not protect you from injury during a collision. You are more likely to hit your head in a collision if you do not wear your shoulder belt. The lap and shoulder belt are meant to be used together.
- A frayed or torn seat belt could rip apart in a collision and leave you with no protection. Inspect the seat belt system periodically, checking for cuts, frays, or loose parts. Damaged parts must be replaced immediately. Do not disassemble or modify the seat belt system. If your vehicle is involved in a collision, or if you have questions regarding seat belt or retractor conditions, take your vehicle to an authorized FCA dealer or authorized FCA Certified Collision Care Program facility for inspection.

## Lap/Shoulder Belt Operating Instructions

1. Enter the vehicle and close the door. Sit back and adjust the seat.
2. The seat belt latch plate is above the back of the front seat, and next to your arm in the rear seat (for vehicles equipped with a rear seat). Grab the latch plate and pull out the seat belt. Slide the latch plate up the webbing as far as necessary to allow the seat belt to go around your lap.

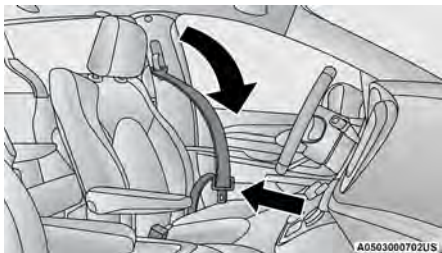

**Pulling Out The Latch Plate**

3. When the seat belt is long enough to fit, insert the latch plate into the buckle until you hear a “click.”

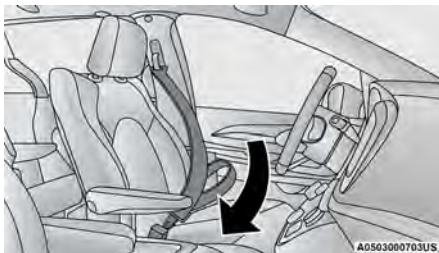

**Inserting Latch Plate Into Buckle**

4. Position the lap belt so it is snug and lies low across your hips, below your abdomen. To remove slack in the lap belt portion, pull up on the shoulder belt. To loosen the lap belt if it is too tight, tilt the latch plate and pull on the lap belt. A snug seat belt reduces the risk of sliding under the seat belt in a collision.

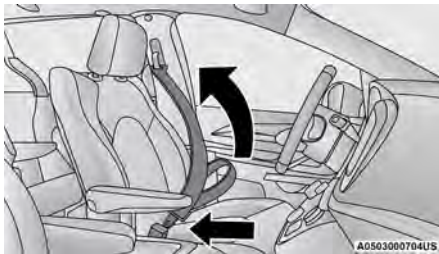

**Positioning The Lap Belt**

5. Position the shoulder belt across the shoulder and chest with minimal, if any, slack so it is comfortable and not resting on your neck. The retractor will withdraw any slack in the shoulder belt.
6. To release the seat belt, push the red button on the buckle. The seat belt will automatically retract to its stowed position. If necessary, slide the latch plate down the webbing to allow the seat belt to retract fully.

## Lap/Shoulder Belt Untwisting Procedure

Use the following procedure to untwist a twisted lap/shoulder belt.

1. Position the latch plate as close as possible to the anchor point.
2. At about 6 to 12 inches (15 to 30 cm) above the latch plate, grab and twist the seat belt webbing 180 degrees to create a fold that begins immediately above the latch plate.
3. Slide the latch plate upward over the folded webbing. The folded webbing must enter the slot at the top of the latch plate.
4. Continue to slide the latch plate up until it clears the folded webbing and the seat belt is no longer twisted.

## Adjustable Upper Shoulder Belt Anchorage

In the front and second row outboard seats the shoulder belt can be adjusted upward or downward to position the seat belt away from your neck. Push or squeeze the anchorage button to release the anchorage, and move it up or down to the position that serves you best.

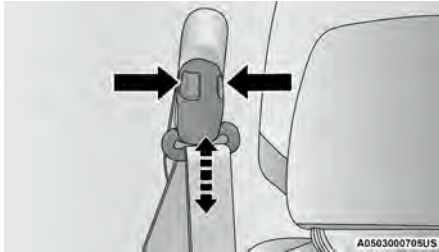

Adjustable Anchorage

As a guide, if you are shorter than average, you will prefer the shoulder belt anchorage in a lower position, and if you are taller than average, you will prefer the shoulder belt anchorage in a higher position. After you release the anchorage button, try to move it up or down to make sure that it is locked in position.

### NOTE:

The adjustable upper shoulder belt anchorage is equipped with an Easy Up feature. This feature allows the shoulder belt anchorage to be adjusted in the upward position without pushing or squeezing the release button. To verify the shoulder belt anchorage is latched, pull downward on the shoulder belt anchorage until it is locked into position.

### WARNING!

- Wearing your seat belt incorrectly could make your injuries in a collision much worse. You might suffer internal injuries, or you could even slide out of the seat belt. Follow these instructions to wear your seat belt safely and to keep your passengers safe, too.
- Position the shoulder belt across the shoulder and chest with minimal, if any, slack so it is comfortable and not resting on your neck. The retractor will withdraw any slack in the shoulder belt.
- Misadjustment of the seat belt could reduce the effectiveness of the safety belt in a crash.
- Always make all seat belt height adjustments when the vehicle is stationary.

## Second Row Center (If Equipped) And Third Row Center Seat Belt Operating Instructions

The second row center (if equipped) and third row center seat belts feature a seat belt with a mini-latch plate and buckle, which allows the seat belt to detach from the lower anchor when the seat is folded. The mini-latch plate and regular latch plate can then be stored out of the way in the headliner for added convenience to open up utilization of the storage areas behind the front seats when the seat is not occupied.

1. Remove the mini-latch plate and regular latch plate from its stowed position in the headliner slightly behind the second or third row seat.



Mini-Latch Stowage

2. Grab the mini-latch plate and pull the seat belt over the seat.



Mini-Latch Plate

3. Route the shoulder belt to the inside of the left head restraint.



**Routing The Rear Seat Belt Latch Plate**

1 – Seat Belt Latch Plate

4. When the seat belt is long enough to fit, insert the mini-latch plate into the mini-buckle until you hear a “click.”

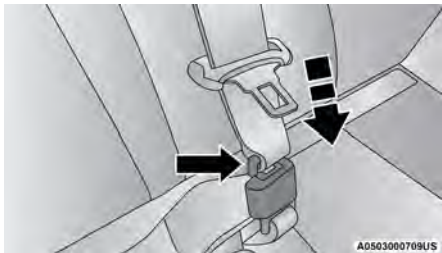

**Connect Mini-Latch To Mini-Buckle**

5. Sit back in seat. Slide the regular latch plate up the webbing as far as necessary to allow the seat belt to go around your lap.

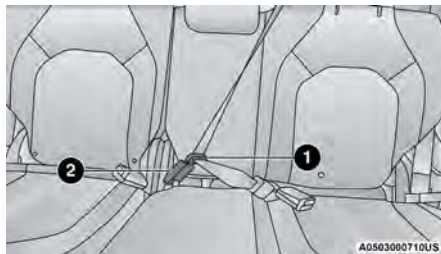

**Rear Center Seat Belt Buckled**

1 – Seat Belt Latch Plate  
2 – Seat Belt Buckle

6. When the seat belt is long enough to fit, insert the latch plate into the buckle until you hear a “click.”

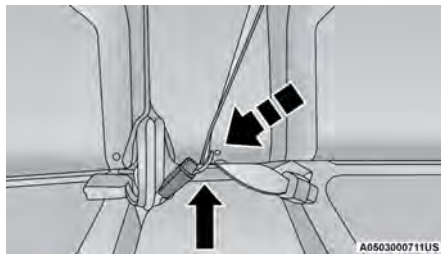

**Latch Plate And Buckle Connected**

7. Position the lap belt so it is snug and lies low across your hips, below your abdomen. To remove slack in the lap belt portion, pull up on the shoulder belt. To loosen the lap belt if it is too tight, pull on the lap belt. A snug seat belt reduces the risk of sliding under the seat belt in a collision.
8. Position the shoulder belt on your chest so it is comfortable and not resting on your neck. The retractor will withdraw any slack in the seat belt.
9. To release the seat belt, push the red button on the buckle.
10. To disengage the mini-latch plate from the mini-buckle for storage, insert the regular latch plate into the center red slot on the mini-buckle. The seat belt will automatically retract to its stowed position. If necessary, slide the latch plate down the webbing to allow the seat belt to retract fully. Insert the mini-latch plate and regular latch plate into its stowed position.

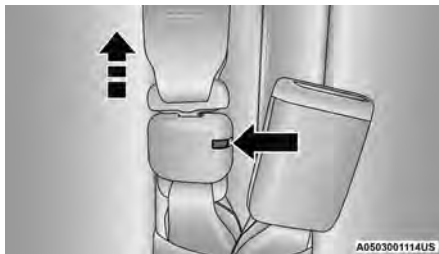

**Insert Regular Latch Plate Into Mini-Buckle Slot To Detach**

**WARNING!**

- If the mini-latch plate and mini-buckle are not properly connected when the seat belt is used by an occupant, the seat belt will not be able to provide proper restraint and will increase the risk of injury in a collision.
- When reattaching the mini-latch plate and mini-buckle, ensure the seat belt webbing is not twisted. If the webbing is twisted, follow the preceding procedure to detach the mini-latch plate and mini-buckle, untwist the webbing, and reattach the mini-latch plate and mini-buckle.

**Seat Belt Extender**

If a seat belt is not long enough to fit properly, even when the webbing is fully extended and the adjustable upper shoulder belt anchorage (if equipped) is in its lowest position, an authorized dealer can provide you with a Seat Belt Extender. The Seat Belt Extender should be used only if the existing seat belt is not long enough. When the Seat Belt Extender is not required for a different occupant, it must be removed.

**WARNING!**

- **ONLY** use a Seat Belt Extender if it is physically required in order to properly fit the original seat belt system. **DO NOT USE** the Seat Belt Extender if, when worn, the distance between the front edge of the Seat Belt Extender buckle and the center of the occupant's body is **LESS** than 6 inches.

*(Continued)*

**WARNING!**

- Using a Seat Belt Extender when not needed can increase the risk of serious injury or death in a collision. Only use the Seat Belt Extender when the lap belt is not long enough and only use in the recommended seating positions. Remove and store the Seat Belt Extender when not needed.

**Seat Belts And Pregnant Women****Seat Belts And Pregnant Women**

Seat belts must be worn by all occupants including pregnant women: the risk of injury in the event of an accident is reduced for the mother and the unborn child if they are wearing a seat belt.

Position the lap belt snug and low below the abdomen and across the strong bones of the hips. Place the shoulder belt across the chest and away from the neck. Never place the shoulder belt behind the back or under the arm.

**Seat Belt Pretensioner**

The front outboard seat belt system is equipped with pretensioning devices that are designed to remove slack from the seat belt in the event of a collision. These devices may improve the performance of the seat belt by removing slack from the seat belt early in a collision. Pretensioners work for all size occupants, including those in child restraints.

**NOTE:**

These devices are not a substitute for proper seat belt placement by the occupant. The seat belt still must be worn snugly and positioned properly.

The pretensioners are triggered by the Occupant Restraint Controller (ORC). Like the air bags, the pretensioners are single use items. A deployed pretensioner or a deployed air bag must be replaced immediately.

**Energy Management Feature**

The front outboard seat belt system is equipped with an Energy Management feature that may help further reduce the risk of injury in the event of a collision. The seat belt system has a retractor assembly that is designed to release webbing in a controlled manner.

## Switchable Automatic Locking Retractors (ALR)

The seat belts in the passenger seating positions are equipped with a Switchable Automatic Locking Retractor (ALR) which is used to secure a child restraint system. The figures illustrate the locking feature for each seating position ↪ page 233.

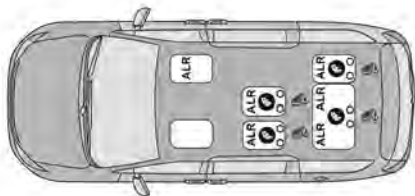

**Seven Passenger Bench Seat Automatic Locking Retractor (ALR) Locations**

ALR — Switchable Automatic Locking Retractor

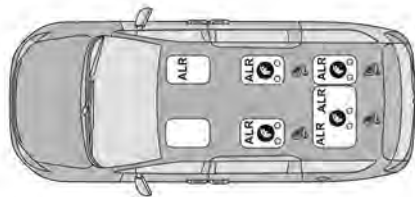

**Seven Passenger Quad Seat Automatic Locking Retractor (ALR) Locations (Includes Stow 'n Go)**

ALR — Switchable Automatic Locking Retractor

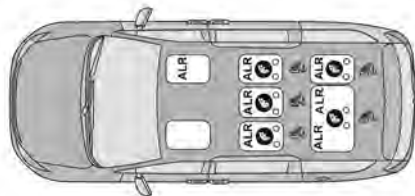

**Eight Passenger Automatic Locking Retractor (ALR) Locations**

ALR — Switchable Automatic Locking Retractor

If the passenger seating position is equipped with an ALR and is being used for normal usage, only pull the seat belt webbing out far enough to comfortably wrap around the occupant's mid-section so as to not activate the ALR. If the ALR is activated, you will hear a clicking sound as the seat belt retracts. Allow the webbing to retract completely in this case and then carefully pull out only the amount of webbing necessary to comfortably wrap around the occupant's mid-section. Slide the latch plate into the buckle until you hear a "click."

In Automatic Locking Mode, the shoulder belt is automatically pre-locked. The seat belt will still retract to remove any slack in the shoulder belt. Use the Automatic Locking Mode anytime a child restraint is installed in a seating position that has a seat belt with this feature. Children 12 years old and under should always be properly restrained in the rear seat of a vehicle with a rear seat.

### WARNING!

- Never place a rear-facing child restraint in front of an air bag. A deploying passenger front air bag can cause death or serious injury to a child 12 years or younger, including a child in a rear-facing child restraint.
- Never install a rear-facing child restraint in the front seat of a vehicle. Only use a rear-facing child restraint in the rear seat. If the vehicle does not have a rear seat, do not transport a rear-facing child restraint in that vehicle.



### How To Engage The Automatic Locking Mode

1. Buckle the combination lap and shoulder belt.
2. Grab the shoulder portion and pull downward until the entire seat belt is extracted.
3. Allow the seat belt to retract. As the seat belt retracts, you will hear a clicking sound. This indicates the seat belt is now in the Automatic Locking Mode.

### How To Disengage The Automatic Locking Mode

Unbuckle the combination lap/shoulder belt and allow it to retract completely to disengage the Automatic Locking Mode and activate the vehicle sensitive (emergency) locking mode.

#### WARNING!

- The seat belt assembly must be replaced if the switchable Automatic Locking Retractor (ALR) feature or any other seat belt function is not working properly when checked according to the procedures in the Service Manual.
- Failure to replace the seat belt assembly could increase the risk of injury in collisions.
- Do not use the Automatic Locking Mode to restrain occupants who are wearing the seat belt or children who are using booster seats. The locked mode is only used to install rear-facing or forward-facing child restraints that have a harness for restraining the child.

### Seat Belt Park Stitch — If Equipped

The rear outboard seat belts may be equipped with a park stitch to raise the latch plate for easier access to occupants. If the park stitch interferes with the tight installation of a child restraint, slide the latch plate over the stitching to shorten the lap portion of the belt and install the car seat normally. When the car seat is removed from the vehicle, slide the latch plate above the park stitch to enable occupants to latch the seat belt securely.

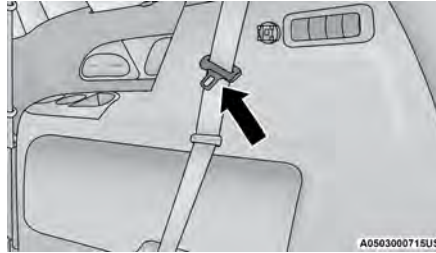

Seat Belt Park Stitch Location

### Third Row Stow Clip — If Equipped

Your vehicle may be equipped with a stow clip on the lower trim behind the third row. This clip is used to hold the seat belt out of the path of the power folding third row seat. Only place the seat belt webbing in this clip while folding and opening the seat. Do not leave the webbing behind the clip when using the belt to restrain an occupant.

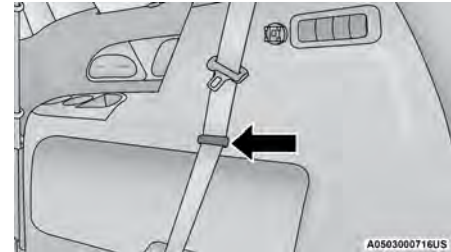

Third Row Stow Clip

#### WARNING!

Do not place the seat belt webbing behind the third row stow clip when using the seat belt to restrain an occupant. The seat belt will not be positioned properly on the occupant and they could be more seriously injured in an accident as a result.

## SUPPLEMENTAL RESTRAINT SYSTEMS (SRS)

Some of the safety features described in this section may be standard equipment on some models, or may be optional equipment on others. If you are not sure, ask an authorized dealer.

The air bag system must be ready to protect you in a collision. The Occupant Restraint Controller (ORC) monitors the internal circuits and interconnecting wiring associated with the electrical Air Bag System Components. Your vehicle may be equipped with the following Air Bag System Components:

### Air Bag System Components

- Occupant Restraint Controller (ORC)
- Air Bag Warning Light 
- Steering Wheel and Column
- Instrument Panel
- Knee Impact Bolsters
- Driver and Front Passenger Air Bags
- Seat Belt Buckle Switch
- Supplemental Side Air Bags
- Supplemental Knee Air Bags
- Front and Side Impact Sensors
- Seat Belt Pretensioners
- Seat Track Position Sensors
- Occupant Classification System

### Air Bag Warning Light



The Occupant Restraint Controller (ORC) monitors the readiness of the electronic parts of the air bag system whenever the ignition switch is in the START or ON/RUN position. If the ignition switch is in the OFF position or in the ACC position, the air bag system is not on and the air bags will not inflate.

The ORC contains a backup power supply system that may deploy the air bag system even if the battery loses power or it becomes disconnected prior to deployment.

The ORC turns on the Air Bag Warning Light in the instrument panel for approximately four to eight seconds for a self-check when the ignition switch is first in the ON/RUN position. After the self-check, the Air Bag Warning Light will turn off. If the ORC detects a malfunction in any part of the system, it turns on the Air Bag Warning Light, either momentarily or continuously. A single chime will sound to alert you if the light comes on again after initial startup.

The ORC also includes diagnostics that will illuminate the instrument panel Air Bag Warning Light if a malfunction is detected that could affect the air bag system. The diagnostics also record the nature of the malfunction. While the air bag system is designed to be maintenance free, if any of the following occurs, have an authorized dealer service the air bag system immediately.

- The Air Bag Warning Light does not come on during the four to eight seconds when the ignition switch is first in the ON/RUN position.
- The Air Bag Warning Light remains on after the four to eight-second interval.
- The Air Bag Warning Light comes on intermittently or remains on while driving.

### NOTE:

If the speedometer, tachometer, or any engine related gauges are not working, the Occupant Restraint Controller (ORC) may also be disabled. In this condition the air bags may not be ready to inflate for your protection. Have an authorized dealer service the air bag system immediately.

### WARNING!

Ignoring the Air Bag Warning Light in your instrument panel could mean you won't have the air bag system to protect you in a collision. If the light does not come on as a bulb check when the ignition is first turned on, stays on after you start the vehicle, or if it comes on as you drive, have an authorized dealer service the air bag system immediately.

### Redundant Air Bag Warning Light



If a fault with the Air Bag Warning Light is detected, which could affect the Supplemental Restraint System (SRS), the Redundant Air Bag Warning Light will illuminate on the instrument panel. The Redundant Air Bag Warning Light will stay on until the fault is cleared. In addition, a single chime will sound to alert you that the Redundant Air Bag Warning Light has come on and a fault has been detected. If the Redundant Air Bag Warning Light comes on intermittently or remains on while driving have an authorized dealer service the vehicle immediately  page 111.

## Front Air Bags

This vehicle has front air bags and lap/shoulder belts for both the driver and front passenger. The front air bags are a supplement to the seat belt restraint systems. The driver front air bag is mounted in the center of the steering wheel. The passenger front air bag is mounted in the instrument panel, above the glove compartment. The words "SRS AIRBAG" or "AIRBAG" are embossed on the air bag covers.

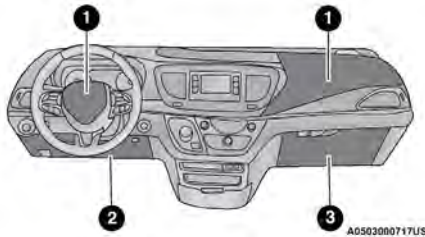

**Front Air Bag/Knee Bolster Locations**

- 1 — Driver And Passenger Front Air Bags  
 2 — Driver Knee Impact Bolster/Supplemental Driver Knee Air Bag  
 3 — Passenger Knee Impact Bolster/Supplemental Passenger Knee Air Bag

### WARNING!

- Being too close to the steering wheel or instrument panel during front air bag deployment could cause serious injury, including death. Air bags need room to inflate. Sit back, comfortably extending your arms to reach the steering wheel or instrument panel.
- Never place a rear-facing child restraint in front of an air bag. A deploying passenger front air bag can cause death or serious injury to a child 12 years or younger, including a child in a rear-facing child restraint.
- Never install a rear-facing child restraint in the front seat of a vehicle. Only use a rear-facing child restraint in the rear seat. If the vehicle does not have a rear seat, do not transport a rear-facing child restraint in that vehicle.

## Driver And Passenger Front Air Bag Features

The Advanced Front Air Bag system has multistage driver and front passenger air bags. This system provides output appropriate to the severity and type of collision as determined by the Occupant Restraint Controller (ORC), which may receive information from the front impact sensors (if equipped) or other system components.

The first stage inflator is triggered immediately during an impact that requires air bag deployment. A low energy output is used in less severe collisions. A higher energy output is used for more severe collisions.

This vehicle may be equipped with a driver and/or front passenger seat belt buckle switch that detects whether the driver or front passenger seat belt is buckled. The seat belt buckle switch may adjust the inflation rate of the Advanced Front Air Bags.

This vehicle may be equipped with driver and/or front passenger seat track position sensors that may adjust the inflation rate of the Advanced Front Air Bags based upon seat position.

This vehicle is equipped with a right front passenger Occupant Classification System (OCS) that is designed to provide Passenger Advanced Front Air Bag output appropriate to the occupant's seated weight input, as determined by the OCS.

### WARNING!

- No objects should be placed over or near the air bag on the instrument panel or steering wheel because any such objects could cause harm if the vehicle is in a collision severe enough to cause the air bag to inflate.
- Do not put anything on or around the air bag covers or attempt to open them manually. You may damage the air bags and you could be injured because the air bags may no longer be functional. The protective covers for the air bag cushions are designed to open only when the air bags are inflating.
- Relying on the air bags alone could lead to more severe injuries in a collision. The air bags work with your seat belt to restrain you properly. In some collisions, air bags won't deploy at all. Always wear your seat belts even though you have air bags.

## Front Air Bag Operation

Front Air Bags are designed to provide additional protection by supplementing the seat belts. Front air bags are not expected to reduce the risk of injury in rear, side, or rollover collisions. The front air bags will not deploy in all frontal collisions, including some that may produce substantial vehicle damage — for example, some pole collisions, truck underrides, and angle offset collisions.

On the other hand, depending on the type and location of impact, front air bags may deploy in crashes with little vehicle front-end damage but that produce a severe initial deceleration.

Because air bag sensors measure vehicle deceleration over time, vehicle speed and damage by themselves are not good indicators of whether or not an air bag should have deployed.

Seat belts are necessary for your protection in all collisions, and also are needed to help keep you in position, away from an inflating air bag.

When the Occupant Restraint Controller (ORC) detects a collision requiring the front air bags, it signals the inflator units. A large quantity of non-toxic gas is generated to inflate the front air bags.

The steering wheel hub trim cover and the upper passenger side of the instrument panel separate and fold out of the way as the air bags inflate to their full size. The front air bags fully inflate in less time than it takes to blink your eyes. The front air bags then quickly deflate while helping to restrain the driver and front passenger.

## Occupant Classification System (OCS) — Front Passenger Seat

The Occupant Classification System (OCS) is part of a Federally regulated safety system for this vehicle. It is designed to provide Passenger Advanced Front Air Bag output appropriate to the occupant's seated weight, as determined by the OCS.

The Occupant Classification System (OCS) consists of the following:

- Occupant Restraint Controller (ORC)
- Occupant Classification Module (OCM) and Sensor located in the front passenger seat
- Air Bag Warning Light 

## Occupant Classification Module (OCM) And Sensor

The Occupant Classification Module (OCM) is located underneath the front passenger seat. The Sensor is located beneath the passenger seat cushion foam. Any weight on the seat will be sensed by the Sensor. The OCM uses input from the Sensor to determine the front passenger's most probable classification. The OCM communicates this information to the ORC. The ORC may reduce the inflation rate of the Passenger Advanced Front Air Bag deployment based on occupant classification. In order for the OCS to operate as designed, it is important for the front passenger to be seated properly and properly wearing the seat belt.

The OCS will NOT prevent deployment of the Passenger Advanced Front Air Bag. The OCS may reduce the inflation rate of the Passenger Advanced Front Air Bag if the OCS estimates that:

- The front passenger seat is unoccupied or has very light objects on it; or
- The front passenger seat is occupied by a small passenger, including a child; or
- The front passenger seat is occupied by a rear-facing child restraint; or
- The front passenger is not properly seated or his or her weight is taken off of the seat for a period of time.

Front Passenger Seat Occupant Status	Front Passenger Air Bag Output
Rear-facing child restraint	Reduced-power deployment
Child, including a child in a forward-facing child restraint or booster seat*	Reduced-power deployment OR Full-power deployment
Properly seated adult	Full-power deployment OR reduced-power deployment
Unoccupied seat	Reduced-power deployment

\* It is possible for a child to be classified as an adult, allowing a full-power Passenger Advanced Front Air Bag deployment. Never allow children to ride in the front passenger seat and never install a child restraint system, including a rear-facing child restraint, in the front passenger seat.

#### WARNING!

- Never place a rear-facing child restraint in front of an air bag. A deploying passenger front air bag can cause death or serious injury to a child 12 years or younger, including a child in a rear-facing child restraint.
- Never install a rear-facing child restraint in the front seat of a vehicle. Only use a rear-facing child restraint in the rear seat. If the vehicle does not have a rear seat, do not transport a rear-facing child restraint in that vehicle.
- Children 12 years or younger should always ride buckled up in the rear seat of a vehicle with a rear seat.

The OCS determines the front passenger's most probable classification. The OCS estimates the seated weight on the front passenger seat and where that weight is located. The OCS communicates the classification status to the ORC. The ORC uses the classification to determine whether the Passenger Advanced Front Air Bag inflation rate should be adjusted.

In order for the OCS to operate as designed, it is important for the front passenger to be seated properly and properly wearing the seat belt. Properly seated passengers are:

- Sitting upright
- Facing forward
- Sitting in the center of the seat with their feet comfortably on or near the floor
- Sitting with their back against the seatback and the seatback in an upright position



Seated Properly

#### Lighter Weight Passengers (Including Small Adults)

When a lighter weight passenger, including a small adult, occupies the front passenger seat, the OCS may reduce the inflation rate of the Passenger Advanced Front Air Bag. This does not mean that the OCS is working improperly.

#### Do not decrease OR increase the front passenger's seated weight on the front passenger seat

The front passenger's seated weight must be properly positioned on the front passenger seat. Failure to do so may result in serious injury or death. The OCS determines the most probable classification of the occupant that it detects. The OCS will detect the front passenger's decreased or increased seated weight, which may result in an adjusted inflation rate of the Passenger Advanced Front Air Bag in a collision. This does not mean that the OCS is working improperly. Decreasing the front passenger's seated weight on the front passenger seat may result in a reduced-power deployment of the Passenger Advanced Front Air Bag. Increasing the front passenger's seated weight on the front passenger seat may result in a full-power deployment of the Passenger Advanced Front Air Bag.

Examples of improper front passenger seating include:

- The front passenger's weight is transferred to another part of the vehicle (like the door, arm rest or instrument panel).
- The front passenger leans forward, sideways, or turns to face the rear of the vehicle.
- The front passenger's seatback is not in the full upright position.
- The front passenger carries or holds an object while seated (e.g., backpack, box, etc.).
- Objects are lodged under the front passenger seat.
- Objects are lodged between the front passenger seat and center console.
- Accessories that may change the seated weight on the front passenger seat are attached to the front passenger seat.
- Anything that may decrease or increase the front passenger's seated weight.

The OCS determines the front passenger's most probable classification. If an occupant in the front passenger seat is seated improperly, the occupant may provide an output signal to the OCS that is different from the occupant's properly seated weight input, for example:



**Not Seated Properly**



**Not Seated Properly**

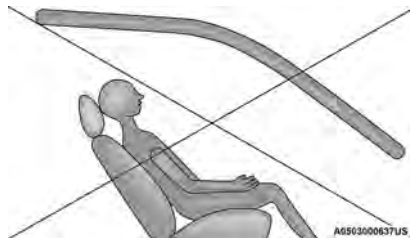

**Not Seated Properly**



**Not Seated Properly**

#### WARNING!

- If a child restraint system, child, small teenager or adult in the front passenger seat is seated improperly, the occupant may provide an output signal to the OCS that is different from the occupant's properly seated weight input. This may result in serious injury or death in a collision.

(Continued)

#### WARNING!

- Always wear your seat belt and sit properly, with the seatback in an upright position, your back against the seatback, sitting upright, facing forward, in the center of the seat, with your feet comfortably on or near the floor.
- Do not carry or hold any objects (e.g., backpacks, boxes, etc.) while seated in the front passenger seat. Holding an object may provide an output signal to the OCS that is different than the occupant's properly seated weight input, which may result in serious injury or death in a collision.
- Placing an object on the floor under the front passenger seat may prevent the OCS from working properly, which may result in serious injury or death in a collision. Do not place any objects on the floor under the front passenger seat.

The Air Bag Warning Light  in the instrument panel will turn on whenever the OCS is unable to classify the front passenger seat status. A malfunction in the OCS may affect the operation of the air bag system.

If the Air Bag Warning Light  does not come on, or stays on after you start the vehicle, or it comes on as you drive, take the vehicle to an authorized dealer for service immediately.

The passenger seat assembly contains critical OCS components that may affect the Passenger Advanced Front Air Bag inflation. In order for the OCS to properly classify the seated weight of a front seat passenger, the OCS components must function as designed. Do not make any modifications to the front passenger seat components, assembly, or to the seat cover.

If the seat, trim cover, or cushion needs service for any reason, take the vehicle to an authorized dealer. Only FCA US LLC approved seat accessories may be used.

The following requirements must be strictly followed:

- Do not modify the front passenger seat assembly or components in any way.
- Do not use prior or future model year seat covers or cushions not designated by FCA US LLC for the specific model being repaired. Always use the correct seat cover and cushion specified for the vehicle.
- Do not replace the seat cover or cushion with an aftermarket seat cover or cushion.
- Do not add a secondary seat cover or mat.
- At no time should any Supplemental Restraint System (SRS) component or SRS related component or fastener be modified or replaced with any part except those which are approved by FCA US LLC.

#### WARNING!

- Unapproved modifications or service procedures to the passenger seat assembly, its related components, seat cover or cushion may inadvertently change the air bag deployment in case of a frontal collision. This could result in death or serious injury to the front passenger if the vehicle is involved in a collision. A modified vehicle may not comply with required Federal Motor Vehicle Safety Standards (FMVSS) and/or Canadian Motor Vehicle Safety Standards (CMVSS).
- If it is necessary to modify the air bag system for persons with disabilities, contact an authorized dealer.

## Knee Impact Bolsters

The Knee Impact Bolsters help protect the knees of the driver and front passenger, and position the front occupants for improved interaction with the front air bags.

#### WARNING!

- Do not drill, cut, or tamper with the knee impact bolsters in any way.
- Do not mount any accessories to the knee impact bolsters such as alarm lights, stereos, citizen band radios, etc.

## Supplemental Driver And Front Passenger Knee Air Bags

This vehicle is equipped with a Supplemental Driver Knee Air Bag mounted in the instrument panel below the steering column and a Supplemental Passenger Knee Air Bag mounted in the instrument panel below the glove compartment. The Supplemental Knee Air Bags provide enhanced protection during a frontal impact by working together with the seat belts, pretensioners, and front air bags.

## Supplemental Side Air Bags

### Supplemental Seat-Mounted Side Air Bags (SABs)

This vehicle is equipped with Supplemental Seat-Mounted Side Air Bags (SABs).

Supplemental Seat-Mounted Side Air Bags (SABs) are located in the outboard side of the front seats. The SABs are marked with "SRS AIRBAG" or "AIRBAG" on a label or on the seat trim on the outboard side of the seats.

The SABs may help reduce the risk of occupant injury during certain side impacts, in addition to the injury reduction potential provided by the seat belts and body structure.



Front Supplemental Seat-Mounted Side Air Bag

When the SAB deploys, it opens the seam on the outboard side of the seatback's trim cover. The inflating SAB deploys through the seat seam into the space between the occupant and the door. The SAB moves at a very high speed and with such a high force that it could injure occupants if they are not seated properly, or if items are positioned in the area where the SAB inflates. Children are at an even greater risk of injury from a deploying air bag.

#### WARNING!

Do not use accessory seat covers or place objects between you and the Side Air Bags; the performance could be adversely affected and/or objects could be pushed into you, causing serious injury.

### Supplemental Side Air Bag Inflatable Curtains (SABICs)

This vehicle is equipped with Supplemental Side Air Bag Inflatable Curtains (SABICs).

Supplemental Side Air Bag Inflatable Curtains (SABICs) are located above the side windows. The trim covering the SABICs is labeled “SRS AIRBAG” or “AIRBAG.”

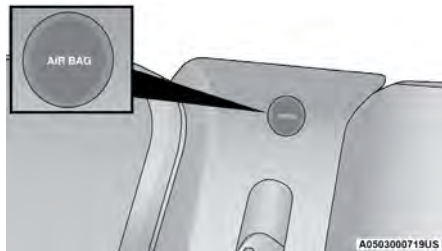

**Supplemental Side Air Bag Inflatable Curtain (SABIC)  
Label Location**

SABICs may help reduce the risk of head and other injuries to front and rear seat outboard occupants in certain side impacts, in addition to the injury reduction potential provided by the seat belts and body structure.

The SABIC deploys downward, covering the side windows. An inflating SABIC pushes the outside edge of the headliner out of the way and covers the window. The SABICs inflate with enough force to injure occupants if they are not belted and seated properly, or if items are positioned in the area where the SABICs inflate. Children are at an even greater risk of injury from a deploying air bag.

The SABICs may help reduce the risk of partial or complete ejection of vehicle occupants through side windows in certain side impact events.

### WARNING!

- Do not mount equipment, or stack luggage or other cargo up high enough to block the deployment of the SABICs. The trim covering above the side windows where the SABIC and its deployment path are located should remain free from any obstructions.
- In order for the SABICs to work as intended, do not install any accessory items in your vehicle which could alter the roof. Do not add an aftermarket sunroof to your vehicle. Do not add roof racks that require permanent attachments (bolts or screws) for installation on the vehicle roof. Do not drill into the roof of the vehicle for any reason.

### Side Impacts

The Side Air Bags are designed to activate in certain side impacts. The Occupant Restraint Controller (ORC) determines whether the deployment of the Side Air Bags in a particular impact event is appropriate, based on the severity and type of collision. The side impact sensors aid the ORC in determining the appropriate response to impact events. The system is calibrated to deploy the Side Air Bags on the impact side of the vehicle during impacts that require Side Air Bag occupant protection. In side impacts, the Side Air Bags deploy independently; a left side impact deploys the left Side Air Bags only and a right-side impact deploys the right Side Air Bags only. Vehicle damage by itself is not a good indicator of whether or not Side Air Bags should have deployed.

The Side Air Bags will not deploy in all side collisions, including some collisions at certain angles, or some side collisions that do not impact the area of the passenger compartment. The Side Air Bags may deploy during angled or offset frontal collisions where the front air bags deploy.

Side Air Bags are a supplement to the seat belt restraint system. Side Air Bags deploy in less time than it takes to blink your eyes.

### WARNING!

- Occupants, including children, who are up against or very close to Side Air Bags can be seriously injured or killed. Occupants, including children, should never lean on or sleep against the door, side windows, or area where the side air bags inflate, even if they are in an infant or child restraint.
- Seat belts (and child restraints where appropriate) are necessary for your protection in all collisions. They also help keep you in position, away from an inflating Side Air Bag. To get the best protection from the Side Air Bags, occupants must wear their seat belts properly and sit upright with their backs against the seats. Children must be properly restrained in a child restraint or booster seat that is appropriate for the size of the child.

### WARNING!

- Side Air Bags need room to inflate. Do not lean against the door or window. Sit upright in the center of the seat.
- Being too close to the Side Air Bags during deployment could cause you to be severely injured or killed.
- Relying on the Side Air Bags alone could lead to more severe injuries in a collision. The Side Air Bags work with your seat belt to restrain you properly. In some collisions, Side Air Bags won't deploy at all. Always wear your seat belt even though you have Side Air Bags.



**NOTE:**

Air bag covers may not be obvious in the interior trim, but they will open during air bag deployment.

**Rollover Events**

Side Air Bags and seat belt pretensioners are designed to activate in certain rollover events. The Occupant Restraint Controller (ORC) determines whether deployment in a particular rollover event is appropriate, based on the severity and type of collision. Vehicle damage by itself is not a good indicator of whether or not Side Air Bags and seat belt pretensioners should have deployed.

The Side Air Bags and seat belt pretensioners will not deploy in all rollover events. The rollover sensing system determines if a rollover event may be in progress and whether deployment is appropriate. In the event the vehicle experiences a rollover or near rollover event, and deployment is appropriate, the rollover sensing system will deploy the side air bags and seat belt pretensioners on both sides of the vehicle.

The SABICs may help reduce the risk of partial or complete ejection of vehicle occupants through side windows in certain rollover or side impact events.

**Air Bag System Components****NOTE:**

The Occupant Restraint Controller (ORC) monitors the internal circuits and interconnecting wiring associated with electrical Air Bag System Components listed below:

- Occupant Restraint Controller (ORC)
- Air Bag Warning Light 
- Steering Wheel and Column
- Instrument Panel
- Knee Impact Bolsters

- Driver and Front Passenger Air Bags
- Seat Belt Buckle Switch
- Supplemental Side Air Bags
- Supplemental Knee Air Bags
- Front and Side Impact Sensors
- Seat Belt Pretensioners
- Seat Track Position Sensors
- Occupant Classification System

**If A Deployment Occurs**

The front air bags are designed to deflate immediately after deployment.

**NOTE:**

Front and/or side air bags will not deploy in all collisions. This does not mean something is wrong with the air bag system.

If you do have a collision which deploys the air bags, any or all of the following may occur:

- The air bag material may sometimes cause abrasions and/or skin reddening to the occupants as the air bags deploy and unfold. The abrasions are similar to friction rope burns or those you might get sliding along a carpet or gymnasium floor. They are not caused by contact with chemicals. They are not permanent and normally heal quickly. However, if you haven't healed significantly within a few days, or if you have any blistering, see your doctor immediately.

- As the air bags deflate, you may see some smoke-like particles. The particles are a normal by-product of the process that generates the non-toxic gas used for air bag inflation. These airborne particles may irritate the skin, eyes, nose, or throat. If you have skin or eye irritation, rinse the area with cool water. For nose or throat irritation, move to fresh air. If the irritation continues, see your doctor. If these particles settle on your clothing, follow the garment manufacturer's instructions for cleaning.

Do not drive your vehicle after the air bags have deployed. If you are involved in another collision, the air bags will not be in place to protect you.

**WARNING!**

Deployed air bags and seat belt pretensioners cannot protect you in another collision. Have the air bags, seat belt pretensioners, and the seat belt retractor assemblies replaced by an authorized dealer immediately. Also, have the Occupant Restraint Controller System serviced as well.

**NOTE:**

- Air bag covers may not be obvious in the interior trim, but they will open during air bag deployment.
- After any collision, the vehicle should be taken to an authorized dealer immediately.

## Enhanced Accident Response System

In the event of an impact, if the communication network remains intact, and the power remains intact, depending on the nature of the event, the Occupant Restraint Controller (ORC) will determine whether to have the Enhanced Accident Response System perform the following functions:

- Cut off fuel to the engine (if equipped).
- Cut off battery power to the electric motor (if equipped).
- Flash hazard lights as long as the battery has power.
- Turn on the interior lights, which remain on as long as the battery has power or for 15 minutes from the intervention of the Enhanced Accident Response System.
- Unlock the power door locks.

Your vehicle may also be designed to perform any of these other functions in response to the Enhanced Accident Response System:

- Turn off the Fuel Filter Heater, Turn off the HVAC Blower Motor, Close the HVAC Circulation Door
- Cut off battery power to the:
  - Engine
  - Electric Motor (if equipped)
  - Electric power steering
  - Brake booster
  - Electric park brake
  - Automatic transmission gear selector
  - Horn
  - Front wiper

### NOTE:

After an accident, place the ignition in the STOP (OFF) position to avoid draining the battery. Carefully check the vehicle for fuel leaks in the engine compartment and on the ground near the engine compartment and fuel tank before resetting the system. If there are no fuel leaks or damage to the vehicle electrical devices (e.g. headlights) after an accident, reset the system by following the procedure described below. If you have any doubt, contact an authorized dealer.

## Enhanced Accident Response System Reset Procedure

In order to reset the Enhanced Accident Response System functions after an event, the ignition switch must be changed from ignition START or ON/RUN to ignition OFF. Carefully check the vehicle for fuel leaks in the engine compartment and on the ground near the engine compartment and fuel tank before resetting the system and starting the engine.

After an accident, if the vehicle will not start after performing the reset procedure, the vehicle must be towed to an authorized dealer to be inspected and to have the Enhanced Accident Response System reset.

## Enhanced Accident Response System Reset Procedure (Hybrid Vehicles)

After an event occurs requiring activation of the Enhanced Accident Response System, when the system is active, a "Service Hybrid Electric Vehicle System" message will be displayed on the instrument cluster. The vehicle is not drivable in this state.

In order to reset the high voltage battery and engine, the vehicle must be towed to an authorized dealer immediately to be inspected and have the Enhanced Accident Response System reset.

In order to immediately reset the hazard flashers, interior lights, power door locks, or the HVAC blower motor, the ignition switch must be changed from START or ON/RUN to ignition OFF.

## Maintaining Your Air Bag System

### WARNING!

- Modifications to any part of the air bag system could cause it to fail when you need it. You could be injured if the air bag system is not there to protect you. Do not modify the components or wiring, including adding any kind of badges or stickers to the steering wheel hub trim cover or the upper passenger side of the instrument panel. Do not modify the front fascia/bumper, vehicle body structure, or add aftermarket side steps or running boards.
- It is dangerous to try to repair any part of the air bag system yourself. Be sure to tell anyone who works on your vehicle that it has an air bag system.
- Do not attempt to modify any part of your air bag system. The air bag may inflate accidentally or may not function properly if modifications are made. Take your vehicle to an authorized dealer for any air bag system service. If your seat, including your trim cover and cushion, needs to be serviced in any way (including removal or loosening/tightening of seat attachment bolts), take the vehicle to an authorized dealer. Only manufacturer approved seat accessories may be used. If it is necessary to modify the air bag system for persons with disabilities, contact an authorized dealer.

## Event Data Recorder (EDR)

This vehicle is equipped with an event data recorder (EDR). The main purpose of an EDR is to record, in certain crash or near crash-like situations, such as an air bag deployment or hitting a road obstacle, data that will assist in understanding how a vehicle's systems performed. The EDR is designed to record data related to vehicle dynamics and safety systems for a short period of time, typically 30 seconds or less. The EDR in this vehicle is designed to record such data as:

- How various systems in your vehicle were operating;
- Whether or not the driver and passenger safety belts were buckled/fastened;
- How far (if at all) the driver was depressing the accelerator and/or brake pedal; and,
- How fast the vehicle was traveling.

These data can help provide a better understanding of the circumstances in which crashes and injuries occur.

### NOTE:

EDR data are recorded by your vehicle only if a non-trivial crash situation occurs; no data are recorded by the EDR under normal driving conditions and no personal data (e.g., name, gender, age, and crash location) are recorded. However, other parties, such as law enforcement, could combine the EDR data with the type of personally identifying data routinely acquired during a crash investigation.

To read data recorded by an EDR, special equipment is required, and access to the vehicle or the EDR is needed. In addition to the vehicle manufacturer, other parties, such as law enforcement, that have the special equipment, can read the information if they have access to the vehicle or the EDR.

## CHILD RESTRAINTS

Everyone in your vehicle needs to be buckled up at all times, including babies and children. Every state in the United States, and every Canadian province, requires that small children ride in proper restraint systems. This is the law, and you can be prosecuted for ignoring it.

Children 12 years or younger should ride properly buckled up in a rear seat, if available. According to crash statistics, children are safer when properly restrained in the rear seats rather than in the front.

### WARNING!

In a collision, an unrestrained child can become a projectile inside the vehicle. The force required to hold even an infant on your lap could become so great that you could not hold the child, no matter how strong you are. The child and others could be badly injured or killed. Any child riding in your vehicle should be in a proper restraint for the child's size.

There are different sizes and types of restraints for children from newborn size to the child almost large enough for an adult safety belt. Always check the child seat Owner's Manual to make sure you have the correct seat for your child. Carefully read and follow all the instructions and warnings in the child restraint Owner's Manual and on all the labels attached to the child restraint.

Before buying any restraint system, make sure that it has a label certifying that it meets all applicable Safety Standards. You should also make sure that you can install it in the vehicle where you will use it.

### NOTE:

- For additional information, refer to <http://www.nhtsa.gov/parents-and-caregivers> or call: 1-888-327-4236
- Canadian residents should refer to Transport Canada's website for additional information: <https://tc.canada.ca/en/road-transportation/child-car-seat-safety>

## Summary Of Recommendations For Restraining Children In Vehicles

	Child Size, Height, Weight Or Age	Recommended Type Of Child Restraint
Infants and Toddlers	Children who are two years old or younger and who have not reached the height or weight limits of their child restraint	Either an Infant Carrier or a Convertible Child Restraint, facing rearward in a rear seat of the vehicle
Small Children	Children who are at least two years old or who have outgrown the height or weight limit of their rear-facing child restraint	Forward-Facing Child Restraint with a five-point Harness, facing forward in a rear seat of the vehicle
Larger Children	Children who have outgrown their forward-facing child restraint, but are too small to properly fit the vehicle's seat belt	Belt Positioning Booster Seat and the vehicle seat belt, seated in a rear seat of the vehicle
Children Too Large for Child Restraints	Children 12 years old or younger, who have outgrown the height or weight limit of their booster seat	Vehicle Seat Belt, seated in a rear seat of the vehicle

### Infant And Child Restraints

Safety experts recommend that children ride rear-facing in the vehicle until they are two years old or until they reach either the height or weight limit of their rear-facing child restraint. Two types of child restraints can be used rear-facing: infant carriers and convertible child seats.

The infant carrier is only used rear-facing in the vehicle. It is recommended for children from birth until they reach the weight or height limit of the infant carrier. Convertible child seats can be used either rear-facing or forward-facing in the vehicle. Convertible child seats often have a higher weight limit in the rear-facing direction than infant carriers do, so they can be used rear-facing by children who have outgrown their infant carrier but are still less than at least two years old. Children should remain rear-facing until they reach the highest weight or height allowed by their convertible child seat.

#### WARNING!

- Never place a rear-facing child restraint in front of an air bag. A deploying passenger front air bag can cause death or serious injury to a child 12 years or younger, including a child in a rear-facing child restraint.
- Never install a rear-facing child restraint in the front seat of a vehicle. Only use a rear-facing child restraint in the rear seat. If the vehicle does not have a rear seat, do not transport a rear-facing child restraint in that vehicle.

#### WARNING!

Do not install a rear-facing car seat using a rear support leg in this vehicle. The floor of this vehicle is not designed to manage the crash forces of this type of car seat. In a crash, the support leg may not function as it was designed by the car seat manufacturer, and your child may be more severely injured as a result.



## Older Children And Child Restraints

Children who are two years old or who have outgrown their rear-facing convertible child seat can ride forward-facing in the vehicle. Forward-facing child seats and convertible child seats used in the forward-facing direction are for children who are over two years old or who have outgrown the rear-facing weight or height limit of their rear-facing convertible child seat. Children should remain in a forward-facing child seat with a harness for as long as possible, up to the highest weight or height allowed by the child seat.

All children whose weight or height is above the forward-facing limit for the child seat should use a belt-positioning booster seat until the vehicle's seat belts fit properly. If the child cannot sit with knees bent over the vehicle's seat cushion while the child's back is against the seatback, they should use a belt-positioning booster seat. The child and belt-positioning booster seat are held in the vehicle by the seat belt.

### WARNING!

- Improper installation can lead to failure of an infant or child restraint. It could come loose in a collision. The child could be badly injured or killed. Follow the child restraint manufacturer's directions exactly when installing an infant or child restraint.
- After a child restraint is installed in the vehicle, do not move the vehicle seat forward or rearward because it can loosen the child restraint attachments. Remove the child restraint before adjusting the vehicle seat position. When the vehicle seat has been adjusted, reinstall the child restraint.

*(Continued)*

### WARNING!

- When your child restraint is not in use, secure it in the vehicle with the seat belt or LATCH anchorages, or remove it from the vehicle. Do not leave it loose in the vehicle. In a sudden stop or accident, it could strike the occupants or seatbacks and cause serious personal injury.

## Children Too Large For Booster Seats

Children who are large enough to wear the shoulder belt comfortably, and whose legs are long enough to bend over the front of the seat when their back is against the seatback, should use the seat belt in a rear seat. Use this simple 5-step test to decide whether the child can use the vehicle's seat belt alone:

1. Can the child sit all the way back against the back of the vehicle seat?
2. Do the child's knees bend comfortably over the front of the vehicle seat while the child is still sitting all the way back?
3. Does the shoulder belt cross the child's shoulder between the neck and arm?
4. Is the lap part of the belt as low as possible, touching the child's thighs and not the stomach?
5. Can the child stay seated like this for the whole trip?

If the answer to any of these questions was "no," then the child still needs to use a booster seat in this vehicle. If the child is using the lap/shoulder belt, check seat belt fit periodically and make sure the seat belt buckle is latched. A child's squirming or slouching can move the belt out of position. If the shoulder belt contacts the face or neck, move the child closer to the center of the vehicle, or use a booster seat to position the seat belt on the child correctly.

### WARNING!

Never allow a child to put the shoulder belt under an arm or behind their back. In a crash, the shoulder belt will not protect a child properly, which may result in serious injury or death. A child must always wear both the lap and shoulder portions of the seat belt correctly.

## Recommendations For Attaching Child Restraints

Restraint Type	Combined Weight of the Child + Child Restraint	Use Any Attachment Method Shown With An "X" Below			
		LATCH – Lower Anchors Only	Seat Belt Only	LATCH – Lower Anchors + Top Tether Anchor	Seat Belt + Top Tether Anchor
Rear-Facing Child Restraint	Up to 65 lb (29.5 kg)	X	X		
Rear-Facing Child Restraint	More than 65 lb (29.5 kg)		X		
Forward-Facing Child Restraint	Up to 65 lb (29.5 kg)			X	X
Forward-Facing Child Restraint	More than 65 lb (29.5 kg)				X

### Lower Anchors And Tethers For Children (LATCH) Restraint System



LATCH Label

Your vehicle is equipped with the child restraint anchorage system called LATCH, which stands for Lower Anchors and Tethers for Children. The LATCH system has three vehicle anchor points for installing LATCH-equipped child seats. There are two lower anchorages located at the back of the seat cushion where it meets the seatback and one top tether anchorage located behind the seating position. These anchorages are used to install LATCH-equipped child seats without using the vehicle's seat belts. Some seating positions may have a top tether anchorage but no lower anchorages. In these seating positions, the seat belt must be used with the top tether anchorage to install the child restraint. Please see the following table for more information.

### LATCH Positions For Installing Child Restraints In This Vehicle

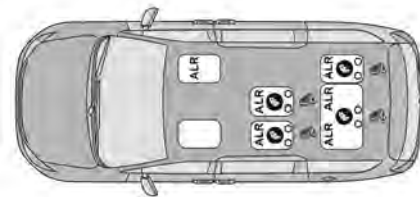

AR503001135US

#### Seven Passenger Bench Seat LATCH Positions

- Lower Anchorage Symbol 2 anchorages per seating position
- Top Tether Anchorage Symbol

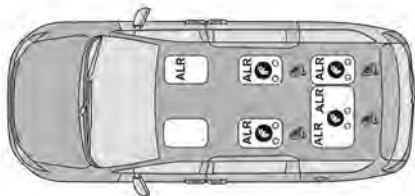

A0503001136US

### Seven Passenger Quad Seat LATCH Positions (Includes Stow 'n Go)

 Lower Anchorage Symbol 2 anchorages per seating position

 Top Tether Anchorage Symbol

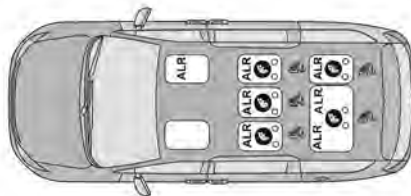

A0503001137US

### Eight Passenger LATCH Positions

 Lower Anchorage Symbol 2 anchorages per seating position

 Top Tether Anchorage Symbol

## Frequently Asked Questions About Installing Child Restraints With LATCH

What is the weight limit (child's weight + weight of the child restraint) for using the LATCH anchorage system to attach the child restraint?	65 lb (29.5 kg)	Use the LATCH anchorage system until the combined weight of the child and the child restraint is 65 lb (29.5 kg). Use the seat belt and tether anchor instead of the LATCH system once the combined weight is more than 65 lb (29.5 kg).
Can the LATCH anchorages and the seat belt be used together to attach a rear-facing or forward-facing child restraint?	No	Do not use the seat belt when you use the LATCH anchorage system to attach a rear-facing or forward-facing child restraint. Booster seats may be attached to the LATCH anchorages if allowed by the booster seat manufacturer. See your booster seat owner's manual for more information.
Can two child restraints be attached using a common lower LATCH anchorage?	No	Never "share" a LATCH anchorage with two or more child restraints. If the center position does not have dedicated LATCH lower anchorages, use the seat belt to install a child seat in the center position next to a child seat using the LATCH anchorages in an outboard position.

### Frequently Asked Questions About Installing Child Restraints With LATCH

Can the rear-facing child restraint touch the back of the front passenger seat?	Yes	The child seat may touch the back of the front passenger seat if the child restraint manufacturer also allows contact. See your child restraint owner's manual for more information.
Can the rear head restraints be removed?	Yes	The 2nd row head restraints on bench and the center head restraint in the 8 passenger vehicle can be removed if they interfere with the installation of the child restraint. 2nd row Quad and Stow 'n Go head restraints are not removable. The 3rd row center head restraint is removable in all vehicles, but the 3rd row outboard head restraints are not removable → page 53.

#### NOTE:

If the folding, non-adjustable head restraint interferes with the installation of the child restraint, the head restraint may be folded and the child seat installed in front of it.

#### WARNING!

Always make sure the head restraint is in its upright position when the seat is to be used by an occupant who is not in a child restraint. Sitting in a seat with the head restraint in its lowered position could result in serious injury or death in a collision.

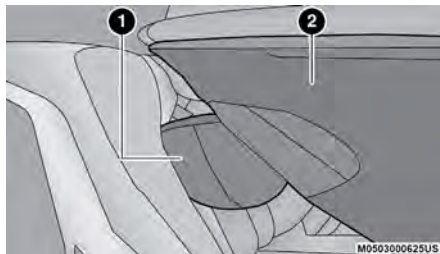

Car Seat With Head Restraint Folded

- 1 — Folded Headrest  
2 — Child Restraint

### Locating The LATCH Anchorages



The lower anchorages are round bars that are found at the rear of the seat cushion where it meets the seatback, below the anchorage symbols on the seatback. They are just visible when you lean into the rear seat to install the child restraint. You will easily feel them if you run your finger along the gap between the seatback and seat cushion.

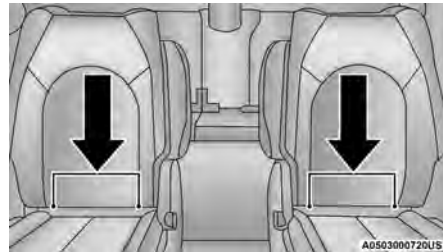

LATCH Anchorages (Second Row Anchorages Shown)  
Seven Passenger Quad and Stow 'n Go Seating



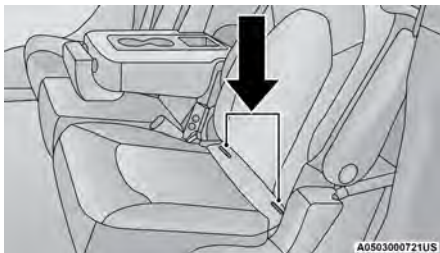

**LATCH Anchorages (Second Row Anchorages Shown)  
Eight Passenger Seating**

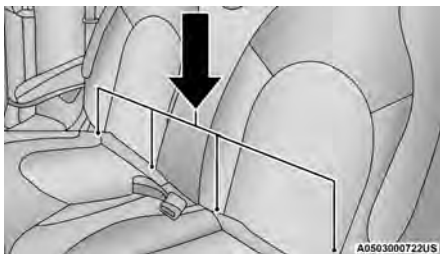

**LATCH Anchorages (Second Row Bench Anchorages  
Shown) Seven Passenger Bench Seating**

## Locating The Upper Tether Anchorages



There are tether strap anchorages located behind all second row seating positions. The third row has a tether anchor on the 40% seat for the right outboard position and in the center of the 60% seat for either the center or left outboard seating position. All tether anchorages are located on the back of the seat, near the floor.

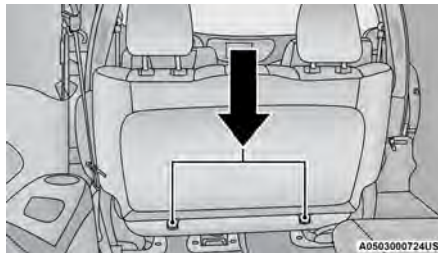

**Tether Strap Anchorages (Second Row Bench Anchorage  
Shown)**

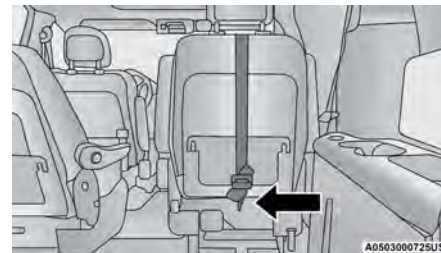

**Tether Strap Anchorages (Second Row Seven Passenger  
Quad and Stow 'n Go Anchorage Shown)**

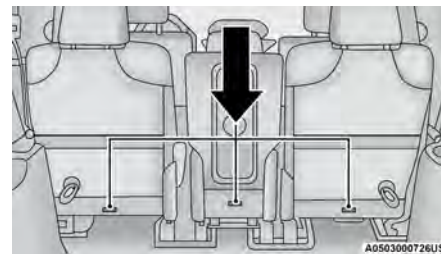

**Tether Strap Anchorages (Second Row Eight Passenger  
Anchorage Shown)**

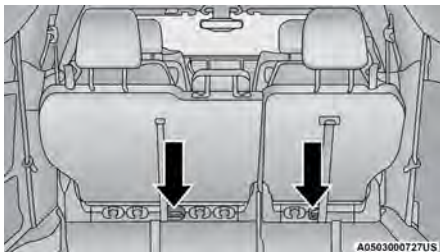

**Tether Strap Anchorages (Third Row 60/40 Anchorage Shown)**

LATCH-compatible child restraint systems will be equipped with a rigid bar or a flexible strap on each side. Each will have a hook or connector to attach to the lower anchorage and a way to tighten the connection to the upper anchorage. Forward-facing child restraints and some rear-facing child restraints will also be equipped with a tether strap. The tether strap will have a hook at the end to attach to the top tether anchorage and a way to tighten the strap after it is attached to the anchorage.

### Center Seat LATCH

This vehicle has 4 lower LATCH anchorages in the third row, rear seat. Anchorages A and B are used for the right outboard position behind the front passenger (1). Anchorages C and D are used for the center seating position (2). The left outboard position (3) does not have lower anchorages. Do not install a child restraint using anchorages B and C. This is not a LATCH position in your vehicle.

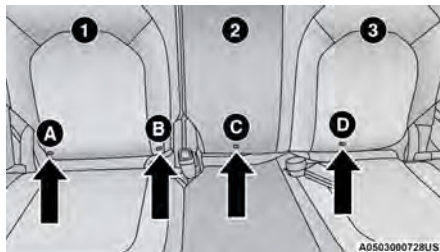

**Center Seat LATCH Positions**

If a child restraint installed in the center position blocks the seat belt webbing or buckle for the outboard position, do not use that outboard position. If a child seat in the center position blocks the outboard LATCH anchors or seat belt, do not install a child seat in that outboard position.

#### WARNING!

- Use anchorages C and D to install a LATCH-compatible child restraint in the center seating position (2). Do not install a LATCH-compatible child restraint using anchorages B and C. This is not a LATCH-compatible position in your vehicle.
- Never use the same lower anchorage to attach more than one child restraint. Please see [page 232](#) for typical installation instructions.

**Always follow the directions of the child restraint manufacturer when installing your child restraint. Not all child restraint systems will be installed as described here.**

### To Install A LATCH-Compatible Child Restraint

If the selected seating position has a Switchable Automatic Locking Retractor (ALR) seat belt, stow the seat belt, following the instructions below. See [page 233](#) to check what type of seat belt each seating position has.

1. Loosen the adjusters on the lower straps and on the tether strap of the child seat so you can more easily attach the hooks or connectors to the vehicle anchorages.
2. Place the child seat between the lower anchorages for that seating position. If the second row seat can be reclined, you may recline the seat and/or raise the head restraint (if adjustable) to get a better fit. If the rear seat can be moved forward and rearward in the vehicle, you may wish to move it to its rear-most position to make room for the child seat. You may also move the front seat forward to allow more room for the child seat.
3. Attach the lower hooks or connectors of the child restraint to the lower anchorages in the selected seating position.
4. If the child restraint has a tether strap, connect it to the top tether anchorage. See [page 236](#) for directions to attach a tether anchor.
5. Tighten all of the straps as you push the child restraint rearward and downward into the seat. Remove slack in the straps according to the child restraint manufacturer's instructions.
6. Test that the child restraint is installed tightly by pulling back and forth on the child seat at the belt path. It should not move more than 1 inch (25.4 mm) in any direction.

## How To Stow An Unused Switchable-ALR (ALR) Seat Belt:

When using the LATCH attaching system to install a child restraint, stow all ALR seat belts that are not being used by other occupants or being used to secure child restraints. An unused belt could injure a child if they play with it and accidentally lock the seat belt retractor. Before installing a child restraint using the LATCH system, buckle the seat belt behind the child restraint and out of the child's reach. If the buckled seat belt interferes with the child restraint installation, instead of buckling it behind the child restraint, route the seat belt through the child restraint belt path and then buckle it. Do not lock the seat belt. Remind all children in the vehicle that the seat belts are not toys and that they should not play with them.

### WARNING!

- Improper installation of a child restraint to the LATCH anchorages can lead to failure of the restraint. The child could be badly injured or killed. Follow the child restraint manufacturer's directions exactly when installing an infant or child restraint.
- Child restraint anchorages are designed to withstand only those loads imposed by correctly-fitted child restraints. Under no circumstances are they to be used for adult seat belts, harnesses, or for attaching other items or equipment to the vehicle.

## Installing Child Restraints Using The Vehicle Seat Belt

Child restraint systems are designed to be secured in vehicle seats by lap belts or the lap belt portion of a lap/shoulder belt.

### WARNING!

- Improper installation or failure to properly secure a child restraint can lead to failure of the restraint. The child could be badly injured or killed.
- Follow the child restraint manufacturer's directions exactly when installing an infant or child restraint.

The seat belts in the passenger seating positions are equipped with a Switchable Automatic Locking Retractor (ALR) that is designed to keep the lap portion of the seat belt tight around the child restraint so that it is not necessary to use a locking clip. The ALR retractor can be "switched" into a locked mode by pulling all of the webbing out of the retractor and then letting the webbing retract back into the retractor. If it is locked, the ALR will make a clicking noise while the webbing is pulled back into the retractor.

See the "Automatic Locking Mode" description for additional information on ALR → page 214.

Please see the table below and the following sections for more information.

## Lap/Shoulder Belt Systems For Installing Child Restraints In This Vehicle

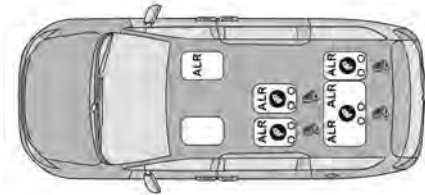

A0503001135U5

### Seven Passenger Bench Seat Automatic Locking Retractor (ALR) Locations

ALR – Switchable Automatic Locking Retractor  
 Top Tether Anchorage Symbol

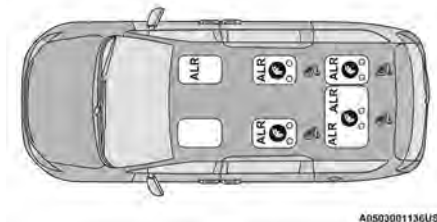

A0503001136US

### Seven Passenger Quad Seat Automatic Locking Retractor (ALR) Locations (Includes Stow 'n Go)

ALR — Switchable Automatic Locking Retractor  
 Top Tether Anchorage Symbol

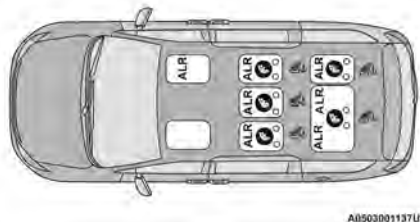

A0503001137US

### Eight Passenger Automatic Locking Retractor (ALR) Locations

ALR — Switchable Automatic Locking Retractor  
 Top Tether Anchorage Symbol

Frequently Asked Questions		
What is the weight limit (child's weight + weight of the child restraint) for using the Tether Anchor with the seat belt to attach a forward-facing child restraint?	Weight limit of the Child Restraint	Always use the tether anchor when using the seat belt to install a forward-facing child restraint, up to the recommended weight limit of the child restraint.
Can the rear-facing child restraint touch the back of the front passenger seat?	Yes	Contact between the front passenger seat and the child restraint is allowed, if the child restraint manufacturer also allows contact.
Can the rear head restraints be removed?	Yes	The 2nd row head restraints on bench and the center head restraint in the 8 passenger vehicle can be removed if they interfere with the installation of the child restraint. 2nd row Quad and Stow 'n Go head restraints are not removable. The 3rd row center head restraint is removable in all vehicles, but the 3rd row outboard head restraints are not removable → page 53.
Can the buckle stalk be twisted to tighten the seat belt against the belt path of the child restraint?	No	Do not twist the buckle stalk in a seating position with an ALR retractor.

**NOTE:**

If the folding, non-adjustable head restraint interferes with the installation of the child restraint, the head restraint may be folded and the child seat installed in front of it.

**WARNING!**

Always make sure the head restraint is in its upright position when the seat is to be used by an occupant who is not in a child restraint. Sitting in a seat with the head restraint in its lowered position could result in serious injury or death in a collision.

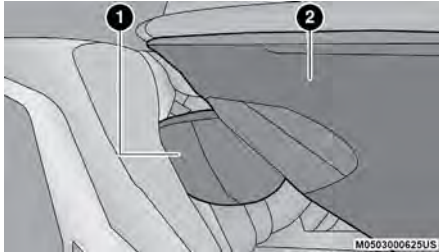

**Car Seat With Head Restraint Folded**

- 1 — Folded Headrest  
2 — Child Restraint

## Installing A Child Restraint With A Switchable Automatic Locking Retractor (ALR):

Child restraint systems are designed to be secured in vehicle seats by lap belts or the lap belt portion of a lap/shoulder belt.

**WARNING!**

- Improper installation or failure to properly secure a child restraint can lead to failure of the restraint. The child could be badly injured or killed.
- Follow the child restraint manufacturer's directions exactly when installing an infant or child restraint.

1. Place the child seat in the center of the seating position. If the second row seat can be reclined, you may recline the seat and/or raise the head restraint (if adjustable) to get a better fit. If the rear seat can be moved forward and rearward in the vehicle, you may wish to move it to its rear-most position to make room for the child seat. You may also move the front seat forward to allow more room for the child seat.
2. Pull enough of the seat belt webbing from the retractor to pass it through the belt path of the child restraint. Do not twist the belt webbing in the belt path.
3. Slide the latch plate into the buckle until you hear a "click."
4. Pull on the webbing to make the lap portion tight against the child seat.
5. To lock the seat belt, pull down on the shoulder part of the belt until you have pulled all the seat belt webbing out of the retractor. Then, allow the web-

bing to retract back into the retractor. As the webbing retracts, you will hear a clicking sound. This means the seat belt is now in the Automatic Locking mode.

6. Try to pull the webbing out of the retractor. If it is locked, you should not be able to pull out any webbing. If the retractor is not locked, repeat step 5.
7. Finally, pull up on any excess webbing to tighten the lap portion around the child restraint while you push the child restraint rearward and downward into the vehicle seat.
8. If the child restraint has a top tether strap and the seating position has a top tether anchorage, connect the tether strap to the anchorage and tighten the tether strap. See  page 236 for directions to attach a tether anchor.
9. Test that the child restraint is installed tightly by pulling back and forth on the child seat at the belt path. It should not move more than 1 inch (25.4 mm) in any direction.

Any seat belt system will loosen with time, so check the belt occasionally, and pull it tight if necessary.

### Seat Belt Park Stitch — If Equipped

The rear outboard seat belts may be equipped with a park stitch to raise the latch plate for easier access to occupants. If the park stitch interferes with the tight installation of a child restraint, slide the latch plate over the stitching to shorten the lap portion of the belt and install the car seat following the steps above. When the car seat is removed from the vehicle, slide the latch plate above the park stitch to enable occupants to latch the seatbelt securely.

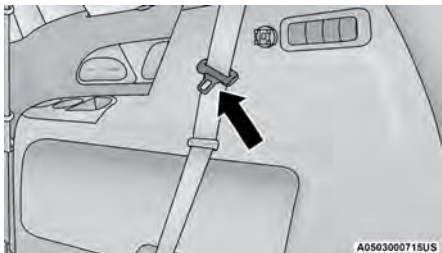

**Seat Belt Park Stitch Location**

If the park stitch interferes with the lock-off features of the child restraint, do not use the lock-off feature. Instead, switch the seat belt to the locking mode, as described in the steps above or move the car seat to a different seating position.

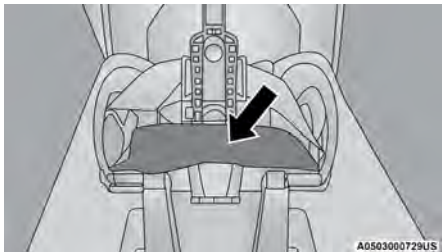

**Seat Belt Park Stitch**

## Installing Child Restraints Using The Top Tether Anchorage

### WARNING!

Do not attach a tether strap for a rear-facing car seat to any location in front of the car seat, including the seat frame or a tether anchorage. Only attach the tether strap of a rear-facing car seat to the tether anchorage that is approved for that seating position, located behind the top of the vehicle seat. See

➡ page 228 for the location of approved tether anchorages in your vehicle.



### Second Row Tether Attachment

1. Look behind the seating position where you plan to install the child restraint to find the tether anchorage. You may need to move the seat forward to provide better access to the tether anchorage. If there is no top tether anchorage for that seating position, move the child restraint to another position in the vehicle if one is available.

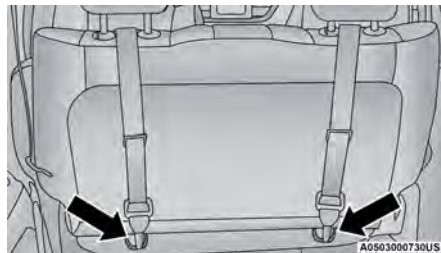

**Top Tether Anchorage Locations 2nd Row Bench**

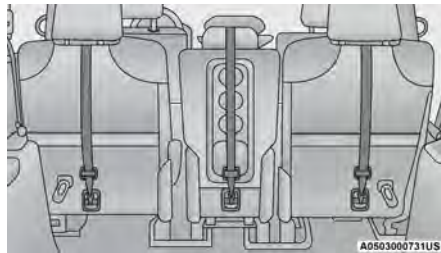

**Top Tether Anchorage Locations 2nd Row Eight Passenger**

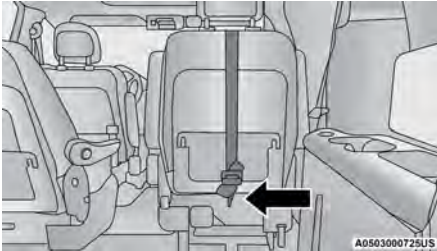

**Rear Seat Tether Strap Attachment (Second Row Seven Passenger Quad and Stow 'n Go Anchorage Shown)**

- Route the tether strap to provide the most direct path for the strap between the anchor and the child seat. If your vehicle is equipped with adjustable rear head restraints, raise the head restraint, and where possible, route the tether strap under the head restraint and between the two posts. If not possible, lower the head restraint and pass the tether strap around the outboard side of the head restraint.
- Attach the tether strap hook of the child restraint to the top tether anchorage as shown in the diagram.
- Remove slack in the tether strap according to the child restraint manufacturer's instructions.

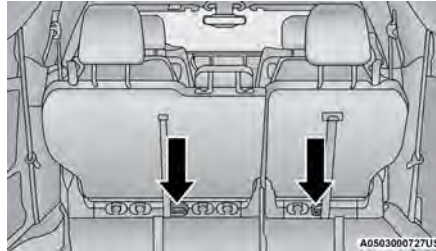

**Top Tether Anchorage Locations 3rd Row**

**WARNING!**

- An incorrectly anchored tether strap could lead to increased head motion and possible injury to the child. Use only the anchorage position directly behind the child seat to secure a child restraint top tether strap.
- If your vehicle is equipped with a split rear seat, make sure the tether strap does not slip into the opening between the seatbacks as you remove slack in the strap.

**Third Row Tether Attachment**

The tether anchorage found on the back of the 60% seat in the third row may be used by either the left outboard or the center seating position. Only tether one child restraint to the tether anchorage at a time.

To connect the tether strap hook to the tether anchorage for either seating position on the 60% third row seat:

- Route the tether strap to provide the most direct path for the strap between the anchor and the child seat.
- If the car seat is in the center, raise the center head restraint and route the tether strap around the inboard (left) side of the head restraint support posts, as shown in the diagram.
- Attach the tether strap hook of the child restraint to the top tether anchorage as shown in the diagram.
- Remove slack in the tether strap according to the child restraint manufacturer's instructions.

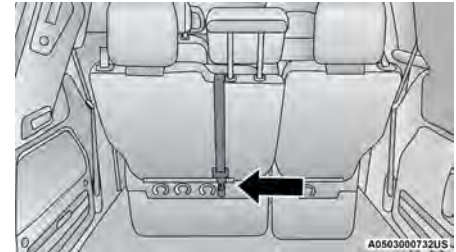

**Center Tether Attachment - 3rd Row**

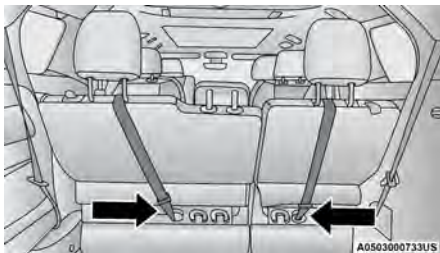

**Outboard Tether Attachments – 3rd Row**

**WARNING!**

Do not connect the tether strap for more than one child restraint to the tether anchorage on the 60% seat in the third row. This anchorage is intended for one child restraint at a time.

## SAFETY TIPS

### TRANSPORTING PASSENGERS

NEVER TRANSPORT PASSENGERS IN THE CARGO AREA.

**WARNING!**

- Do not leave children or animals inside parked vehicles in hot weather. Interior heat buildup may cause serious injury or death.

*(Continued)*

**WARNING!**

- It is extremely dangerous to ride in a cargo area, inside or outside of a vehicle. In a collision, people riding in these areas are more likely to be seriously injured or killed.
- Do not allow people to ride in any area of your vehicle that is not equipped with seats and seat belts.
- Be sure everyone in your vehicle is in a seat and using a seat belt properly.

## TRANSPORTING PETS

Air Bags deploying in the front seat could harm your pet. An unrestrained pet will be thrown about and possibly injured, or injure a passenger during panic braking or in a collision.

Pets should be restrained in the rear seat (if equipped) in pet harnesses or pet carriers that are secured by seat belts.

## CONNECTED VEHICLES

Privacy of any wireless and wired communications cannot be ensured. Third parties may unlawfully intercept information and private communications without your consent. For further information, refer to “Data Collection & Privacy” in your Uconnect Radio Instruction Manual or “Onboard Diagnostic System (OBD II) Cybersecurity” ↪ page 117.

**WARNING!**

It is not possible to know or to predict all of the possible outcomes if your vehicle’s systems are breached. It may be possible that vehicle systems, including safety related systems, could be impaired or a loss of vehicle control could occur that may result in an accident involving serious injury or death.

## SAFETY CHECKS YOU SHOULD MAKE INSIDE THE VEHICLE

### Seat Belts

Inspect the seat belt system periodically, checking for cuts, frays, and loose parts. Damaged parts must be replaced immediately. Do not disassemble or modify the system.

If your vehicle is involved in a collision, or if you have questions regarding seat belt or retractor conditions, take your vehicle to an authorized FCA dealer or authorized FCA Certified Collision Care Program facility for inspection.

### Air Bag Warning Light



The Air Bag Warning Light will turn on for four to eight seconds as a bulb check when the ignition switch is first placed in the ON/RUN mode. If the light is either not on during starting, stays on, or turns on while driving, have the system inspected at an authorized dealer as soon as possible. After the bulb check, this light will illuminate with a single chime when a fault with the Air Bag System has been detected. It will stay on until the fault is removed. If the light comes on intermittently or remains on while driving, have an authorized dealer service the vehicle immediately ↪ page 207.



## Defroster

Check operation by selecting the defrost mode and place the blower control on high speed. You should be able to feel the air directed against the windshield. See an authorized dealer for service if your defroster is inoperable.

## Floor Mat Safety Information

Always use floor mats designed to fit your vehicle. Only use a floor mat that does not interfere with the operation of the accelerator, brake or clutch pedals. Only use a floor mat that is securely attached using the floor mat fasteners so it cannot slip out of position and interfere with the accelerator, brake or clutch pedals or impair safe operation of your vehicle in other ways.

### WARNING!

An improperly attached, damaged, folded, or stacked floor mat, or damaged floor mat fasteners may cause your floor mat to interfere with the accelerator, brake, or clutch pedals and cause a loss of vehicle control. To prevent **SERIOUS INJURY** or **DEATH**:

- ALWAYS securely attach your floor mat using the floor mat fasteners. DO NOT install your floor mat upside down or turn your floor mat over. Lightly pull to confirm mat is secured using the floor mat fasteners on a regular basis.
- ALWAYS REMOVE THE EXISTING FLOOR MAT FROM THE VEHICLE before installing any other floor mat. NEVER install or stack an additional floor mat on top of an existing floor mat.



(Continued)

### WARNING!

- ONLY install floor mats designed to fit your vehicle. NEVER install a floor mat that cannot be properly attached and secured to your vehicle. If a floor mat needs to be replaced, only use a FCA US LLC approved floor mat for the specific make, model, and year of your vehicle.
- ONLY use the driver's side floor mat on the driver's side floor area. To check for interference, with the vehicle properly parked with the engine off, fully depress the accelerator, the brake, and the clutch pedal (if present) to check for interference. If your floor mat interferes with the operation of any pedal, or is not secure to the floor, remove the floor mat from the vehicle and place the floor mat in your trunk.
- ONLY use the passenger's side floor mat on the passenger's side floor area.
- ALWAYS make sure objects cannot fall or slide into the driver's side floor area when the vehicle is moving. Objects can become trapped under accelerator, brake, or clutch pedals and could cause a loss of vehicle control.
- NEVER place any objects under the floor mat (e.g., towels, keys, etc.). These objects could change the position of the floor mat and may cause interference with the accelerator, brake, or clutch pedals.
- If the vehicle carpet has been removed and re-installed, always properly attach carpet to the floor and check the floor mat fasteners are secure to the vehicle carpet. Fully depress each pedal to check for interference with the accelerator, brake, or clutch pedals then re-install the floor mats.

(Continued)

### WARNING!

- It is recommended to only use mild soap and water to clean your floor mats. After cleaning, always check your floor mat has been properly installed and is secured to your vehicle using the floor mat fasteners by lightly pulling mat.

## PERIODIC SAFETY CHECKS YOU SHOULD MAKE OUTSIDE THE VEHICLE

### Tires

Examine tires for excessive tread wear and uneven wear patterns. Check for stones, nails, glass, or other objects lodged in the tread or sidewall. Inspect the tread for cuts and cracks. Inspect sidewalls for cuts, cracks, and bulges. Check the lug nut/bolt torque for tightness. Check the tires (including spare) for proper cold inflation pressure.

### Lights

Have someone observe the operation of brake lights and exterior lights while you work the controls. Check turn signal and high beam indicator lights on the instrument panel.

### Door Latches

Check for proper closing, latching, and locking.

## Fluid Leaks

Check area under the vehicle after overnight parking for fuel, coolant, oil, or other fluid leaks. Also, if gasoline fumes are detected or if fuel or brake fluid leaks are suspected, the cause should be located and corrected immediately.

## EXHAUST GAS

### WARNING!

Exhaust gases can injure or kill. They contain carbon monoxide (CO), which is colorless and odorless. Breathing it can make you unconscious and can eventually poison you. To avoid breathing (CO), follow these safety tips:

- Do not run the engine in a closed garage or in confined areas any longer than needed to move your vehicle in or out of the area.
- If you are required to drive with the trunk/liftgate/rear doors open, make sure that all windows are closed and the climate control BLOWER switch is set at high speed. DO NOT use the recirculation mode.
- If it is necessary to sit in a parked vehicle with the engine running, adjust your heating or cooling controls to force outside air into the vehicle. Set the blower at high speed.

The best protection against carbon monoxide entry into the vehicle body is a properly maintained engine exhaust system.

Whenever a change is noticed in the sound of the exhaust system, when exhaust fumes can be detected inside the vehicle, or when the underside or rear of the vehicle is damaged, have an authorized dealer inspect the complete exhaust system and adjacent body areas for broken, damaged, deteriorated, or mispositioned parts. Open seams or loose connections could permit exhaust fumes to seep into the passenger compartment. In addition, inspect the exhaust system each time the vehicle is raised for lubrication or oil change. Replace as required.

## CARBON MONOXIDE WARNINGS

### WARNING!

Carbon monoxide (CO) in exhaust gases is deadly. Follow the precautions provided to prevent carbon monoxide poisoning:

- Do not inhale exhaust gases. They contain carbon monoxide, a colorless and odorless gas, which can kill. Never run the engine in a closed area, such as a garage, and never sit in a parked vehicle with the engine running for an extended period. If the vehicle is stopped in an open area with the engine running for more than a short period, adjust the ventilation system to force fresh, outside air into the vehicle.
- Guard against carbon monoxide with proper maintenance. Have the exhaust system inspected every time the vehicle is raised. Have any abnormal conditions repaired promptly. Until repaired, drive with all side windows fully open.
- When exiting the vehicle, always make sure the ignition is in the OFF position, remove the key fob from the vehicle, and lock your vehicle.

# IN CASE OF EMERGENCY

## HAZARD WARNING FLASHERS

The Hazard Warning Flashers button is located in the lower center area of the instrument panel.



**Hazard Warning Flashers Button**

Push the button to turn on the Hazard Warning Flashers. When the button is activated, all directional turn signals will flash on and off to warn oncoming traffic of an emergency. Push the button a second time to turn off the Hazard Warning Flashers.

This is an emergency warning system and it should not be used when the vehicle is in motion. Use it only when your vehicle is disabled or signaling a safety hazard warning for other motorists.

When you must leave the vehicle to seek assistance, the Hazard Warning Flashers will continue to operate even though the ignition is placed in the OFF position.

### NOTE:

With extended use, the Hazard Warning Flashers may wear down your battery.

## SOS AND ASSIST MIRROR — IF EQUIPPED

If equipped, the rearview mirror contains an SOS and ASSIST button.

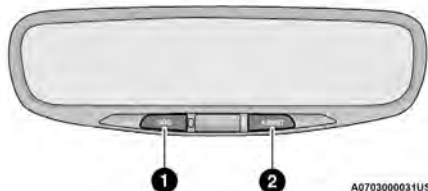

**SOS And ASSIST Mirror**

- 1 — SOS Button  
2 — ASSIST Button

### WARNING!

ALWAYS obey traffic laws and pay attention to the road. ALWAYS drive safely with your hands on the steering wheel. You have full responsibility and assume all risks related to the use of the features and applications in this vehicle. Only use the features and applications when it is safe to do so. Failure to do so may result in an accident involving serious injury or death.

### NOTE:

- Your vehicle may be transmitting data as authorized by the subscriber ↔ page 318.
- The SOS and ASSIST buttons will only function if you are connected to an operable LTE (voice/data) or 4G (data) network, which comes as a built-in function. Other Uconnect services will only be operable if your SiriusXM Guardian™ service is active and you are connected to an operable LTE (voice/data) or 4G (data) network.

**SOS Call**

1. Push the SOS Call button on the Rearview Mirror.

**NOTE:**

In case the SOS Call button is pushed in error, there will be a 10 second delay before the SOS Call system initiates a call to an SOS operator. To cancel the SOS Call connection, push the SOS Call button on the Rearview Mirror or press the cancellation button on the Device Screen. Termination of the SOS Call will turn off the green LED light on the Rearview Mirror.

2. The LED light located between the SOS and ASSIST buttons on the Rearview Mirror will turn green once a connection to an SOS operator has been made.
3. Once a connection between the vehicle and an SOS operator is made, the SOS Call system may transmit the following important vehicle information to an SOS operator:
  - Indication that the occupant placed an SOS Call
  - The vehicle brand
  - The last known GPS coordinates of the vehicle
4. You should be able to speak with the SOS operator through the vehicle audio system to determine if additional assistance is needed.

**WARNING!**

ALWAYS obey traffic laws and pay attention to the road. ALWAYS drive safely with your hands on the steering wheel. You have full responsibility and assume all risks related to the use of the features and applications in this vehicle. Only use the features and applications when it is safe to do so. Failure to do so may result in an accident involving serious injury or death.

**NOTE:**

- Your vehicle may be transmitting data as authorized by the subscriber.
  - Once a connection is made between the vehicle's SOS Call system and the SOS operator, the SOS operator may be able to open a voice connection with the vehicle to determine if additional assistance is needed. Once the SOS operator opens a voice connection with the vehicle's SOS Call system, the operator should be able to speak with you or other vehicle occupants and hear sounds occurring in the vehicle. The vehicle's SOS Call system will attempt to remain connected with the SOS operator until the SOS operator terminates the connection.
5. The SOS operator may attempt to contact appropriate emergency responders and provide them with important vehicle information and GPS coordinates.

**WARNING!**

- If anyone in the vehicle could be in danger (e.g., fire or smoke is visible, dangerous road conditions or location), do not wait for voice contact from an Emergency Services Agent. All occupants should exit the vehicle immediately and move to a safe location.
- Never place anything on or near the vehicle's operable network and GPS antennas. You could prevent operable network and GPS signal reception, which can prevent your vehicle from placing an emergency call. An operable network and GPS signal reception is required for the SOS Call system to function properly.
- The SOS Call system is embedded into the vehicle's electrical system. Do not add aftermarket electrical equipment to the vehicle's electrical system. This may prevent your vehicle from sending a signal to initiate an emergency call. To avoid interference that can cause the SOS Call system to fail, never add aftermarket equipment (e.g., two-way mobile radio, CB radio, data recorder, etc.) to your vehicle's electrical system or modify the antennas on your vehicle. IF YOUR VEHICLE LOSES BATTERY POWER FOR ANY REASON (INCLUDING DURING OR AFTER AN ACCIDENT), THE UCONNECT FEATURES, APPS AND SERVICES, AMONG OTHERS, WILL NOT OPERATE.
- Modifications to any part of the SOS Call system could cause the air bag system to fail when you need it. You could be injured if the air bag system is not there to help protect you.

**SOS Call System Limitations**

Vehicles sold in Mexico **DO NOT** have SOS Call system capabilities.

SOS or other emergency line operators in Mexico may not answer or respond to SOS system calls.

If the SOS Call system detects a malfunction, any of the following may occur at the time the malfunction is detected, and at the beginning of each ignition cycle:

- The Rearview Mirror light located between the SOS and ASSIST buttons will continuously be illuminated red.
- The Device Screen will display the following message “Vehicle device requires service. Please contact an authorized dealer.”
- An In-Vehicle Audio message will state “Vehicle device requires service. Please contact an authorized dealer.”

<b>WARNING!</b>
<ul style="list-style-type: none"> <li>• Ignoring the Rearview Mirror light could mean you will not have SOS Call services. If the Rearview Mirror light is illuminated, have an authorized dealer service the SOS Call system immediately.</li> <li>• The Occupant Restraint Control module turns on the Air Bag Warning Light on the instrument panel if a malfunction in any part of the system is detected. If the Air Bag Warning Light is illuminated, have an authorized dealer service the Occupant Restraint Control system immediately.</li> </ul>

Even if the SOS Call system is fully functional, factors beyond FCA US LLC’s control may prevent or stop the SOS Call system operation. These include, but are not limited to, the following factors:

- The ignition is in the OFF position
- The vehicle’s electrical systems are not intact

- The SOS Call system software and/or hardware are damaged during a crash
- The vehicle battery loses power or becomes disconnected during a vehicle crash
- LTE (voice/data) or 4G (data) network and/or Global Positioning Satellite signals are unavailable or obstructed
- Equipment malfunction at the SOS operator facility
- Operator error by the SOS operator
- LTE (voice/data) or 4G (data) network congestion
- Weather
- Buildings, structures, geographic terrain, or tunnels

<b>WARNING!</b>
<p>ALWAYS obey traffic laws and pay attention to the road. ALWAYS drive safely with your hands on the steering wheel. You have full responsibility and assume all risks related to the use of the features and applications in this vehicle. Only use the features and applications when it is safe to do so. Failure to do so may result in an accident involving serious injury or death.</p>

**NOTE:**

- Your vehicle may be transmitting data as authorized by the subscriber.
- Never place anything on or near the vehicle’s LTE (voice/data) or 4G (data) and GPS antennas. You could prevent LTE (voice/data) or 4G (data) and GPS signal reception, which can prevent your vehicle from placing an emergency call. An operable LTE (voice/data) or 4G (data) network connection and a GPS signal is required for the SOS Call system to function properly.

**NOTE:**

Changes or modifications not expressly approved by the party responsible for compliance could void the user’s authority to operate the equipment.

**Automatic SOS — If Equipped**

Automatic SOS is a hands-free safety service that can immediately connect you with help in the event that your vehicle’s air bags deploy. Please refer to your provided radio supplement for complete information.

**ASSIST Call**

The ASSIST button is used to automatically connect you to any one of the following support centers:

- Roadside Assistance – If you get a flat tire, or need a tow, just push the ASSIST button and you will be connected to a representative for assistance. Roadside Assistance will know what vehicle is being driven and its location. Additional fees may apply for roadside assistance.
- SiriusXM Guardian™ Customer Care – In-vehicle support for SiriusXM Guardian™.
- Vehicle Customer Care – Total support for all other vehicle issues.
- Uconnect Customer Care – Total support for Radio, Phone and NAV issues.

<b>CAUTION!</b>
<p>To avoid damage to the mirror during cleaning, never spray any cleaning solution directly onto the mirror. Apply the solution onto a clean cloth and wipe the mirror clean.</p>

## JACKING AND TIRE CHANGING — IF EQUIPPED

Use this QR code to access your digital experience.



### WARNING!

- Do not attempt to change a tire on the side of the vehicle close to moving traffic. Pull far enough off the road to avoid the danger of being hit when operating the jack or changing the wheel.
- Being under a jacked-up vehicle is dangerous. The vehicle could slip off the jack and fall on you. You could be crushed. Never put any part of your body under a vehicle that is on a jack. If you need to get under a raised vehicle, take it to a service center where it can be raised on a lift.
- The jack is designed to be used as a tool for changing tires only. The jack should not be used to lift the vehicle for service purposes. The vehicle should be jacked on a firm level surface only. Avoid ice or slippery areas.

## PREPARATIONS FOR JACKING

1. Park the vehicle on a firm, level surface. Avoid ice or slippery areas.

### WARNING!

Do not attempt to change a tire on the side of the vehicle close to moving traffic. Pull far enough off the road to avoid being hit when operating the jack or changing the wheel.

2. Turn on the Hazard Warning Flashers.
3. Apply the parking brake.
4. Place the gear selector into PARK (P).
5. Place the ignition in OFF mode.
6. Block both the front and rear of the wheel diagonally opposite the jacking position. For example, if the driver's front wheel is being changed, block the passenger's rear wheel.

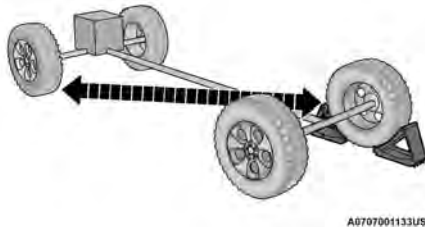

Wheel Blocked Example

### NOTE:

Passengers should not remain in the vehicle when the vehicle is being lifted or raised.

## JACK AND SPARE TIRE LOCATION

The jacking tools, spare tire and Portable Air Compressor (if equipped) or Tire Service Kit (if equipped) are stowed behind an access panel on the left hand side of the vehicle.

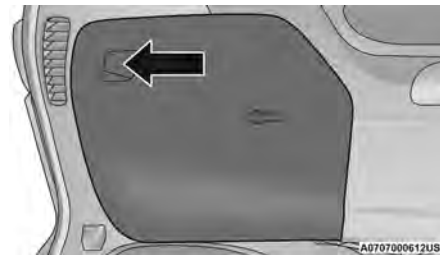

Jacking Equipment Location

## EQUIPMENT REMOVAL

1. Remove the access panel to the jacking equipment.
2. Unlatch the Portable Air Compressor or Tire Service Kit if equipped. Unscrew the wing nut that is holding the Inflatable Spare Tire and gently remove it from the storage area. Remove wrench from foam tray.

### NOTE:

Depending on the trim level of the vehicle, the options for spare tire equipment may vary.

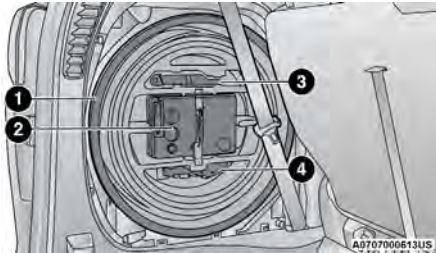

**Jacking Equipment**

- 1 – Inflatable Spare Tire
- 2 – Tire Service Kit
- 3 – Wrench
- 4 – Fuel Filler Funnel

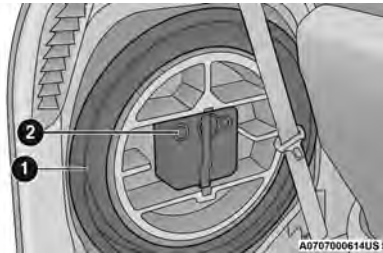

**Jacking Equipment**

- 1 – Inflatable Spare Tire
- 2 – Portable Air Compressor

3. Turn the jack screw counterclockwise to remove the jack from the storage area behind the tire.

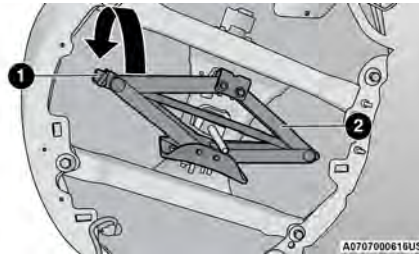

**Jack Location**

- 1 – Jack Screw
- 2 – Jack

## JACKING INSTRUCTIONS

### WARNING!

- Carefully follow these tire changing warnings to help prevent personal injury or damage to your vehicle:
- Always park on a firm, level surface as far from the edge of the roadway as possible before raising the vehicle.
  - Turn on the Hazard Warning Flashers.
  - Apply the parking brake firmly and set the transmission in PARK.
  - Block the wheel diagonally opposite the wheel to be raised.

(Continued)

### WARNING!

- Do not let any passenger sit in the vehicle when it is on a jack.
- Do not get under the vehicle when it is on a jack. If you need to get under a raised vehicle, take it to a service center where it can be raised on a lift.
- Only use the jack in the positions indicated and for lifting this vehicle during a tire change.
- If working on or near a roadway, be extremely careful of motor traffic.



060600714

### Jack Warning Label

### CAUTION!

Do not attempt to raise the vehicle by jacking on locations other than those indicated in the Jacking Instructions for this vehicle.

Detailed information about the inflatable spare tire, its use, and operation ⇨ page 301.

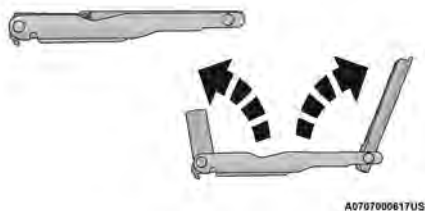

#### Extending The Wrench

1. Loosen (but do not remove) the wheel lug nuts by turning them to the left, one turn while the wheel is still on the ground.
2. There are two jack engagement locations on each side of the vehicle body. These locations are on the sill flange of the vehicle body.

#### NOTE:

Placement for the front and rear jacking locations are critical. See the following images for proper jacking locations.

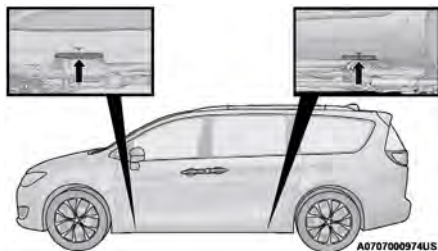

#### Jacking Locations

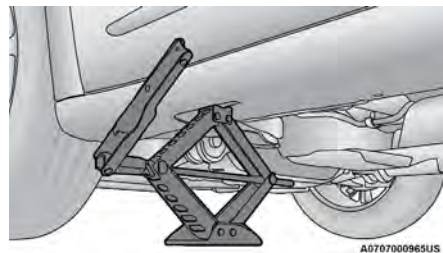

#### Front Jack Location

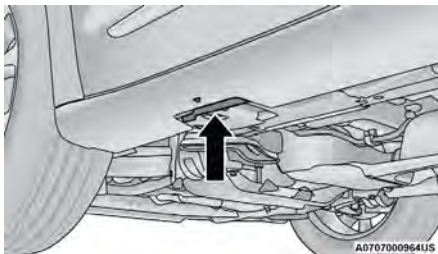

#### Front Lifting Point

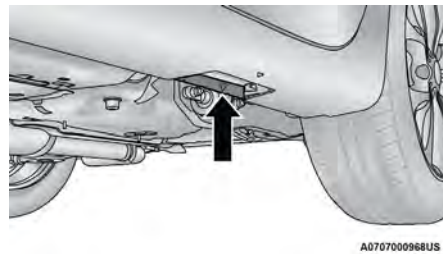

#### Rear Lifting Point



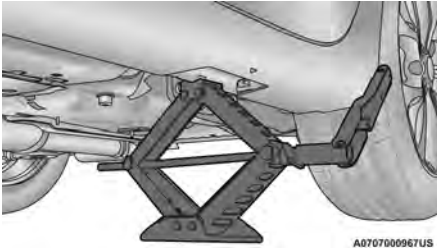

Rear Jacking Location

**WARNING!**

Being under a jacked-up vehicle is dangerous. The vehicle could slip off the jack and fall on you. You could be crushed. Never get any part of your body under a vehicle that is on a jack. If you need to get under a raised vehicle, take it to a service center where it can be raised on a lift.

**CAUTION!**

Do not attempt to raise the vehicle by jacking on locations other than those indicated.

- Place the wrench on the jack screw and turn clockwise until the jack head is properly engaged in the described location. **Do not raise the vehicle until you are sure the jack is securely engaged.**
- Raise the vehicle by turning the jack screw clockwise using the swivel wrench. Raise the vehicle only until the tire just clears the surface and enough clearance is obtained to install the compact spare tire. Minimum tire lift provides maximum stability.

**WARNING!**

Raising the vehicle higher than necessary can make the vehicle less stable. It could slip off the jack and hurt someone near it. Raise the vehicle only enough to remove the tire.

- Remove the wheel lug nuts. For vehicles with wheel covers, remove the cover from the wheel by hand. Do not pry the wheel cover off. Then pull the wheel off the hub.
- Install the inflatable spare on the vehicle, located in the rear cargo area of the vehicle.

**WARNING!**

To avoid the risk of forcing the vehicle off the jack, do not tighten the wheel nuts fully until the vehicle has been lowered. Failure to follow this warning may result in serious injury.

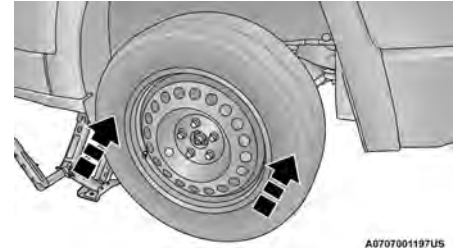

Mounting Inflatable Spare Tire

**CAUTION!**

Be sure to mount the inflatable spare tire with the valve stem facing outward. The vehicle could be damaged if the inflatable spare tire is mounted incorrectly.

**NOTE:**

Do not install the wheel cover on the inflatable spare tire.

- Leave the vehicle on the jack and start inflating the inflatable spare after the tire has been mounted to the vehicle. Secure the wheel to the hub by tightening the nuts with the wrench. After inflation, once the vehicle is lowered you will have a second opportunity to torque the lug nuts → page 309.
- Inflate the tire to the prescribed pressure 60 psi (4.2 bar) using the Portable Air Compressor → page 249 or Tire Service Kit if equipped → page 250.

9. Lower the vehicle once the inflatable Spare has reached its pressure and the compressor-hose has been removed from the tire valve.
10. Finish tightening the lug nuts. Push down on the wrench while at the end of the handle for increased leverage. Tighten the lug nuts in a star pattern until each nut has been tightened twice → page 309. If in doubt about the correct tightness, have them checked with a torque wrench by an authorized dealer or at a service station.
11. Lower the jack to its fully-closed position.

**WARNING!**

A loose tire or jack thrown forward in a collision or hard stop could endanger the occupants of the vehicle. Always stow the jack parts and the spare tire in the places provided. Have the deflated (flat) tire repaired or replaced immediately.

12. Place the deflated (flat) tire and foam tray cover assembly in the rear cargo area. **Do not stow the deflated tire in the inflatable spare tire location.** Have the full-sized tire repaired or replaced, as soon as possible.
13. Stow the jack back in the stowage compartment and place the access panel back. The stud of the storage area must be threaded through the lower part of the jack. Then turn the Jack Screw clockwise to secure it in place.

**NOTE:**

Stow the foam tray and components in the cargo area.

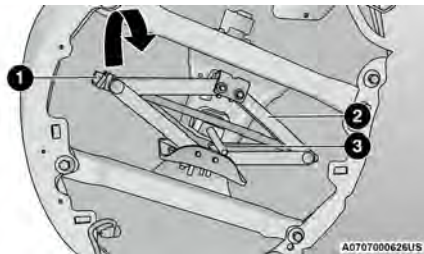
**Storing The Jack**

- 1 – Jack Screw
- 2 – Jack
- 3 – Stud

**ROAD TIRE INSTALLATION****Vehicles Equipped With Wheel Covers**

1. Mount the road tire on the axle.
2. To ease the installation process for steel wheels with wheel covers, install two lug nuts on the mounting studs which are on each side of the valve stem. Install the lug nuts with the cone shaped end of the nut toward the wheel. Lightly tighten the lug nuts.

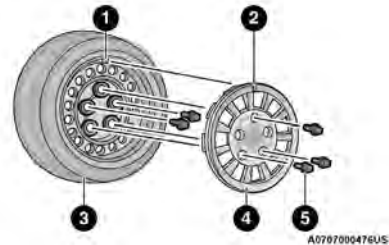
**Tire And Wheel Cover Or Center Cap**

- 1 – Valve Stem
- 2 – Valve Notch
- 3 – Road Tire
- 4 – Wheel Cover
- 5 – Wheel Lug Nut

3. Align the valve notch in the wheel cover with the valve stem on the wheel. Install the cover by hand, snapping the cover over the two lug nuts. Do not use a hammer or excessive force to install the cover.
4. Install the remaining lug nuts with the cone shaped end of the nut toward the wheel. Lightly tighten all the lug nuts until the wheel sits flush onto the hub and there is no play. The nuts will have to be fully tightened once the vehicle is lowered. Tightening an improperly seated wheel under vehicle load can damage the threads, cause vibration, and undermine safety.

**WARNING!**

To avoid the risk of forcing the vehicle off the jack, do not tighten the wheel nuts fully until the vehicle has been lowered. Failure to follow this warning may result in serious injury.

- Lower the vehicle to the ground by turning the jack handle counterclockwise.
- Finish tightening the lug nuts. Push down on the wrench while at the end of the handle for increased leverage. Tighten the lug nuts in a star pattern until each nut has been tightened twice → page 309. If in doubt about the correct tightness, have them checked with a torque wrench by an authorized dealer or at a service station.
- After 25 miles (40 km) check the lug nut torque with a torque wrench to ensure that all lug nuts are properly seated against the wheel.

## PORTABLE AIR COMPRESSOR — IF EQUIPPED

Your vehicle may be equipped with a Portable Air Compressor. Use the Portable Air Compressor located in the side compartment of the cargo area to inflate the inflatable tire to 60 psi (4.2 Bar).

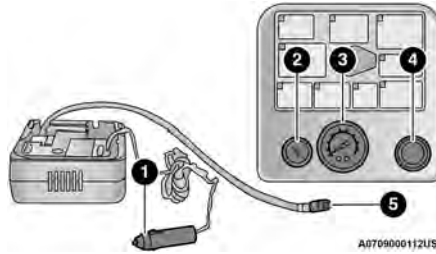

**Portable Air Compressor**

- Power Plug
- Deflation Button
- Pressure Gauge
- Power Button
- Air Hose

### Portable Air Compressor Usage With Inflatable Spare Tire

- Remove the Portable Air Compressor from the storage location.
- Raise the vehicle as described in the Jacking Instructions section.
- Install the inflatable spare tire as described in the Jacking Instructions section in this manual. Make sure that the valve stem is located near the ground, and then screw the air hose of the Portable Air Compressor to the valve stem.



- Uncoil the power plug and connect it to the vehicle's 12 Volt power outlet.
- Always start the engine before turning ON the Portable Air Compressor.
- Switch the power button ON.



- Inflate the tire to 60 psi (4.2 bar) recommended as per the label on the wheel or, if equipped, with the inflatable spare tire pressure indicated on the Tire And Loading Information Label located on the driver-side door opening.



### NOTE:

If the tire is overinflated, use the deflation button to reduce the tire air pressure.

- After the tire reaches the recommended pressure, lower the vehicle with the jack as described in the Jacking Instructions section.
- Remove the speed limit label sticker from the Portable Air Compressor and place it on the center of the steering wheel.
- Return the Portable Air Compressor to the foam tray and secure it with the strap. Store the foam tray in the cargo area.



**WARNING!**

- Do not lift or carry the Portable Air Compressor by the hose.
- Always stow the Portable Air Compressor only in the provided place.
- The metal end fitting from Power Plug may get hot after use, so it should be handled carefully.
- Keep the Portable Air Compressor away from open flames or heat sources.

**RETURN INFLATABLE SPARE TIRE**

To return the inflatable spare tire to its storage location:

1. Return the Jack.
2. Use the Tire Service Kit or Portable Air Compressor to deflate the spare tire. Use the deflation button, see the Portable Air Compressor in this section for additional information. The inflatable spare tire will return to its original shape.
3. Install the inflatable spare tire back into its original stowage location and position facing outward.
4. Install the foam tray with wrench and funnel installed.
5. Install and tighten the wing nut by hand.
6. Install the Tire Service Kit or Portable Air Compressor (if equipped) and tighten the strap.
7. Install access panel door.

**TIRE SERVICE KIT — IF EQUIPPED**

Use this QR code to access your digital experience.



Your vehicle may be equipped with a Tire Service Kit. Small punctures up to 1/4 inch (6 mm) in the tire tread can be sealed with Tire Service Kit. Foreign objects (e.g., screws or nails) should not be removed from the tire. Tire Service Kit can be used in outside temperatures down to approximately -4 °F (-20 °C). This kit will provide a temporary tire seal, allowing you to drive your vehicle up to 100 miles (160 km) with a maximum speed of 50 mph (80 km/h).

**Tire Service Kit Storage**

Remove the rear panel to access the Tire Service Kit.

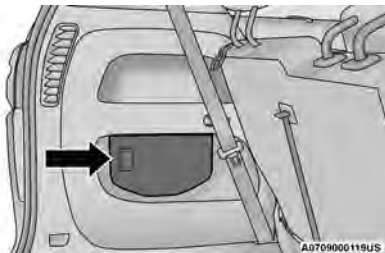

**Tire Service Kit Access Panel Location — If Equipped**

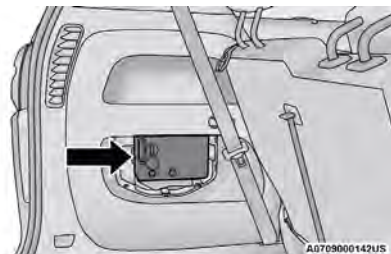

**Tire Service Kit**

**NOTE:**

Depending on the vehicle's trim level, Tire Service Kit storage locations may vary.

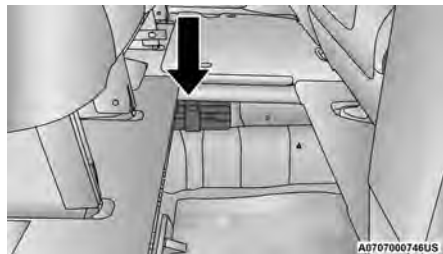

**Tire Service Kit Location — If Equipped**

The Tire Service Kit is secured with a strap, and is stored under the load floor within the second row.

## Tire Service Kit Components And Operation

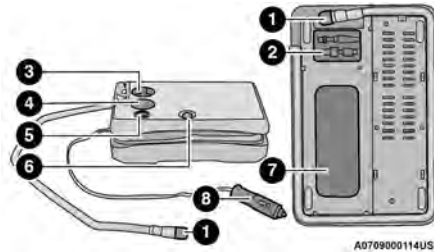

**Tire Service Kit Components**

- 1 – Sealant/Air Hose
- 2 – Hose Accessories
- 3 – Mode Select Knob
- 4 – Pressure Gauge
- 5 – Deflation Button
- 6 – Power Switch
- 7 – Sealant Bottle
- 8 – Power Plug

### Using The Mode Select Knob And Hoses

Your Tire Service Kit is equipped with the following symbols to indicate the air or sealant mode.

- **Selecting Air Mode**

Push in the Mode Select Knob and turn to this position for air pump operation only.



- **Selecting Sealant Mode**

Push in the Mode Select Knob and turn to this position to inject the Tire Service Kit Sealant and to inflate the tire.



- **Using The Power Button**

Push and release the Power Button once to turn On the Tire Service Kit. Push and release the Power Button again to turn Off the Tire Service Kit.



- **Using The Deflation Button**

Push the Deflation Button to reduce the air pressure in the tire if it becomes overinflated.



### Tire Service Kit Usage Precautions

- Replace the Tire Service Kit Sealant Bottle prior to the expiration date (printed at the lower right hand corner on the bottle label) to assure optimum operation of the system. See the Sealant Bottle Replacement in this section for further information.
- The Sealant Bottle is a one tire application use and needs to be replaced after each use. Always replace these components immediately at your original equipment vehicle dealer.
- When the Tire Service Kit sealant is in a liquid form, clean water, and a damp cloth will remove the material from the vehicle or tire and wheel components. Once the sealant dries, it can easily be peeled off and properly discarded.
- For optimum performance, make sure the valve stem on the wheel is free of debris before connecting the Tire Service Kit.
- The Tire Service Kit Sealant is only intended to seal punctures less than 1/4 inch (6 mm) diameter in the tread/contact surface of your vehicle's tires.
- The Tire Service Kit Sealant is not intended to seal punctures on the tires' side walls.

- You can use the Tire Service Kit air pump to inflate bicycle tires. The kit also comes with two needles, located in the Accessory Storage Compartment (on the bottom of the air pump) for inflating sport balls, rafts, or similar inflatable items. However, use only the Air Pump and make sure the Mode Select Knob is in the Air Mode when inflating such items to avoid injecting sealant into them.
- Do not lift or carry the Tire Service Kit by the hoses.

### WARNING!

- Do not attempt to seal a tire on the side of the vehicle closest to traffic. Pull far enough off the road to avoid the danger of being hit when using the Tire Service Kit.
- Do not use Tire Service Kit or drive the vehicle under the following circumstances:
  - If the puncture in the tire tread is approximately 1/4 inch (6 mm) or larger.
  - If the tire has any sidewall damage.
  - If the tire has any damage from driving with extremely low tire pressure.
  - If the tire has any damage from driving on a flat tire.
  - If the wheel has any damage.
  - If you are unsure of the condition of the tire or the wheel.
- Keep Tire Service Kit away from open flames or heat source.
- A loose Tire Service Kit thrown forward in a collision or hard stop could endanger the occupants of the vehicle. Always stow the Tire Service Kit in the place provided. Failure to follow these warnings can result in injuries that are serious or fatal to you, your passengers, and others around you.

(Continued)



**WARNING!**

- Take care not to allow the contents of Tire Service Kit to come in contact with hair, eyes, or clothing. Tire Service Kit sealant is harmful if inhaled, swallowed, or absorbed through the skin. It causes skin, eye, and respiratory irritation. Flush immediately with plenty of water if there is any contact with eyes or skin. Change clothing as soon as possible, if there is any contact with clothing.
- Tire Service Kit Sealant solution contains latex. In case of an allergic reaction or rash, consult a physician immediately. Keep Tire Service Kit out of reach of children. If swallowed, rinse mouth immediately with plenty of water and drink plenty of water. Do not induce vomiting! Consult a physician immediately.

**Sealing A Tire With Tire Service Kit****Whenever You Stop To Use Tire Service Kit:**

1. Pull over to a safe location and turn on the vehicle's Hazard Warning Flashers.
2. Verify that the valve stem (on the wheel with the deflated tire) is in a position that is near to the ground. This will allow the Tire Service Kit Hose to reach the valve stem and keep the Tire Service Kit flat on the ground. This will provide the best positioning of the kit when injecting the sealant into the deflated tire and running the air pump. Move the vehicle as necessary to place the valve stem in this position before proceeding.
3. Place the gear selector in PARK, then push and release the ENGINE START/STOP button to set the ignition switch to the OFF position.
4. Apply the parking brake.



**Setting Up To Use Tire Service Kit:**

1. Uncoil the Sealant Hose and then remove the cap from the fitting at the end of the hose.
2. Place the Tire Service Kit flat on the ground next to the deflated tire. 
3. Remove the cap from the valve stem and then screw the fitting at the end of the Sealant Hose onto the valve stem.
4. Uncoil the Power Plug and insert the plug into the vehicle's 12 Volt power outlet. 

**NOTE:**

Do not remove foreign objects (e.g., screws or nails) from the tire.

**Injecting Tire Service Kit Sealant Into The Deflated Tire:**

1. Always start the vehicle before turning the Tire Service Kit on. 
2. Ensure the Mode Select Knob is to the Sealant Mode position. 
3. After pushing the Power Button, the sealant (white fluid) will flow from the Sealant Bottle through the Sealant Hose and into the tire. 



**NOTE:**

Sealant may leak out through the puncture in the tire.

**If the sealant (white fluid) does not flow within 0 – 10 seconds through the Sealant Hose:**

1. Push the Power Button to turn the Tire Service Kit off. Disconnect the Sealant Hose from the valve stem. Make sure the valve stem is free of debris. Reconnect the Sealant Hose to the valve stem. Check that the Mode Select Knob is in the Sealant Mode position and not Air Mode. Push the Power Button to turn the Tire Service Kit on.
2. Connect the Power Plug to a different 12 Volt power outlet in your vehicle or another vehicle, if available. Make sure the vehicle is running before turning the Tire Service Kit on.
3. The Sealant Bottle may be empty due to previous use. Call for assistance.

**If the sealant (white fluid) does flow through the Sealant Hose:**

1. Continue to operate the pump until sealant is no longer flowing through hose (typically takes 30 - 70 seconds). As the sealant flows through the Sealant Hose, the Pressure Gauge can read as high as 70 psi (4.8 bar). The Pressure Gauge will decrease quickly from approximately 70 psi (4.8 bar) to the actual tire pressure when the Sealant Bottle is empty. 
2. The pump will start to inject air into the tire immediately after the Sealant Bottle is empty. Continue to operate the pump and inflate the tire to the cold tire inflation pressure found on the Tire And Loading Information Label located in the driver-side door opening. Check the tire pressure by looking at the Pressure Gauge. 

If the tire does not inflate to at least 26 psi (1.8 bar) within 15 minutes:

- The tire is too badly damaged. Do not attempt to drive the vehicle further. Call for assistance.

If the tire inflates to the recommended pressure or is at least 26 psi (1.8 bar) within 15 minutes:

#### NOTE:

If the tire becomes overinflated, push the Deflation Button to reduce the tire pressure to the recommended inflation pressure before continuing.

1. Push the Power Button to turn the Tire Service Kit off.



2. Remove the speed limit label from the Tire Service Kit and place sticker on the steering wheel.



3. Immediately disconnect the Sealant Hose from the valve stem, reinstall the cap on the fitting at the end of the hose, and place the Tire Service Kit in the vehicle storage location.

#### Drive Vehicle:



Immediately after injecting sealant and inflating the tire, drive the vehicle 5 miles (8 km) or 10 minutes to ensure distribution of the Tire Service Kit Sealant within the tire. Do not exceed 50 mph (80 km/h).

#### WARNING!

The Tire Service Kit is not a permanent flat tire repair. Have the tire inspected and repaired or replaced after using the Tire Service Kit. Do not exceed 50 mph (80 km/h) until the tire is repaired or replaced. Failure to follow this warning can result in injuries that are serious or fatal to you, your passengers, and others around you. Have the tire checked as soon as possible at an authorized dealer.

#### After Driving:

- Pull over to a safe location and turn on the vehicle's Hazard Warning Flashers.
- Verify that the valve stem (on the wheel of the deflated tire) is in a position that is near to the ground. This will allow the Tire Service Kit Hose to reach the valve stem and keep the Tire Service Kit flat on the ground. This will provide the best positioning of the kit when injecting the sealant into the deflated tire and running the air pump. Move the vehicle as necessary to place the valve stem in this position before proceeding.
- Place the transmission in PARK (P) and cycle the ignition in the OFF position.
- Apply the parking brake.

#### NOTE:

If tire has improper inflation follow these next steps:

1. Uncoil the Sealant Hose, and then remove the cap from the fitting at the end of the hose.
2. Place the Tire Service Kit flat on the ground next to the deflated tire.



3. Remove the cap from the valve stem, and then screw the fitting at the end of the Sealant Hose onto the valve stem.
4. Uncoil the Power Plug and insert the plug into the vehicle's 12 Volt power outlet.
5. Uncoil the Hose and screw the fitting at the end of the hose onto the valve stem.
6. Turn the Mode Select Knob and turn to the Air Mode position.
7. Check the pressure in the tire by reading the Pressure Gauge.



#### If tire pressure is less than 19 psi (1.3 bar):

The tire is too badly damaged. Do not attempt to drive the vehicle further. Call for assistance.

#### If the tire pressure is 19 psi (1.3 bar) or higher:

1. Push the Power Button to turn on Tire Service Kit and inflate the tire to the cold tire inflation pressure found on the Tire And Loading Information Label located in the driver-side door opening.



#### NOTE:

If the tire becomes overinflated, push the Deflation Button to reduce the tire pressure to the recommended inflation pressure before continuing.

2. Disconnect the Tire Service Kit from the valve stem, reinstall the cap on the valve stem and unplug from 12 Volt outlet.

- Place the Tire Service Kit in its proper storage area in the vehicle.
- Have the tire inspected and repaired or replaced at the earliest opportunity at an authorized dealer or tire service center.
- Remove the Speed Limit sticker from the steering wheel after the tire has been repaired.
- Replace the Sealant Bottle at an authorized dealer as soon as possible.

**NOTE:**

When having the tire serviced, advise the authorized dealer or service center that the tire has been sealed using the Tire Service Kit.

**Sealant Bottle Replacement:**

- Unwrap the power cord.
- Unwrap the hose.

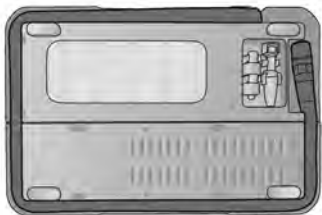

A0709000070US

**Hose Location**

- Remove the bottle cover.

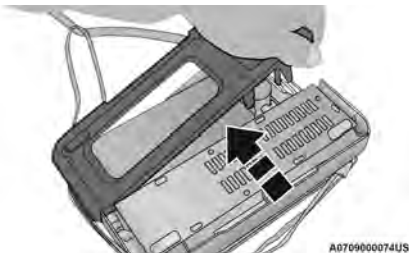

A0709000074US

**Remove The Bottle Cover**

- Rotate the bottle up beyond vertical to release.

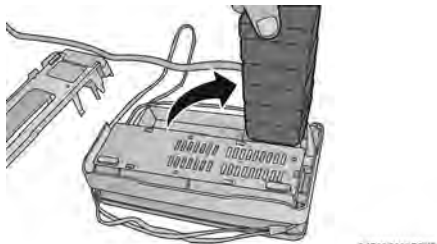

A0709000075US

**Rotate The Bottle Up**

- Pull the bottle away from the Compressor.

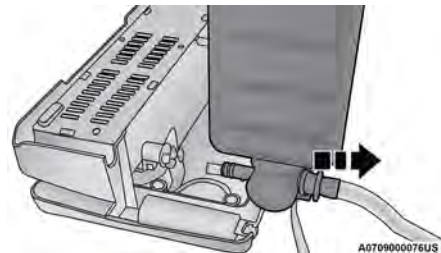

A0709000076US

**Remove The Bottle****NOTE:**

- For sealant bottle installation, follow these steps in reverse order.
- Replacement sealant bottles are available at authorized service centers.

**JUMP STARTING — GAS MODELS**

If your vehicle has a discharged battery it can be jump started using a set of jumper cables and a battery in another vehicle or by using a portable battery booster pack. Jump starting can be dangerous if done improperly so please follow the procedures in this section carefully.

**NOTE:**

When using a portable battery booster pack follow the manufacturer's operating instructions and precautions. Jump starting can be dangerous if done improperly so please follow the procedures in this section carefully.



**NOTE:**

When using a portable battery booster pack, follow the manufacturer's operating instructions and precautions.

**WARNING!**

Do not attempt jump starting if the battery is frozen. It could rupture or explode and cause personal injury.

**CAUTION!**

Do not use a portable battery booster pack or any other booster source with a system voltage greater than 12 Volts or damage to the battery, starter motor, alternator or electrical system may occur.

## PREPARATIONS FOR JUMP START — GAS MODELS

The battery in your vehicle is located on the driver's side of the engine compartment.

**WARNING!**

- Take care to avoid the radiator cooling fan whenever the hood is raised. It can start anytime the ignition switch is ON. You can be injured by moving fan blades.
- Remove any metal jewelry such as rings, watch bands and bracelets that could make an inadvertent electrical contact. You could be seriously injured.

*(Continued)*

**WARNING!**

- Batteries contain sulfuric acid that can burn your skin or eyes and generate hydrogen gas which is flammable and explosive. Keep open flames or sparks away from the battery.

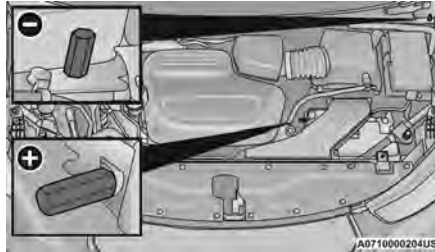

**Battery Location**

**NOTE:**

The positive battery post may be covered with a protective cap. Lift up on the cap to gain access to the positive battery post. Do not jump off fuses. Only jump directly off positive post which has a positive (+) symbol on or around the post.

See the following steps to prepare for jump starting:

1. Apply the parking brake, shift the automatic transmission into PARK (P) and place the ignition to OFF.
2. Turn off the heater, radio, and all electrical accessories.
3. Pull upward and remove the protective cap over the positive (+) battery post.

4. If using another vehicle to jump start the battery, park the vehicle within the jumper cable's reach, set the parking brake and make sure the ignition is OFF.

**WARNING!**

Do not allow vehicles to touch each other as this could establish a ground connection and personal injury could result.

## JUMP STARTING PROCEDURE — GAS MODELS

**WARNING!**

Failure to follow this jump starting procedure could result in personal injury or property damage due to battery explosion.

**CAUTION!**

Failure to follow these procedures could result in damage to the charging system of the booster vehicle or the discharged vehicle.

### Connecting The Jumper Cables

1. Connect the positive (+) end of the jumper cable to the positive (+) post of the vehicle with the discharged battery.
2. Connect the opposite end of the positive (+) jumper cable to the positive (+) post of the booster battery.
3. Connect the negative (-) end of the jumper cable to the negative (-) post of the booster battery.

- Connect the opposite end of the negative (-) jumper cable to the remote negative (-) post near the windshield cowl (exposed metallic/unpainted post of the discharged vehicle).

**WARNING!**

Do not connect the jumper cable to the negative (-) post of the discharged battery. The resulting electrical spark could cause the battery to explode and could result in personal injury.

- Start the engine in the vehicle that has the booster battery, let the engine idle a few minutes, and then start the engine in the vehicle with the discharged battery.
- Once the vehicle starts, follow the disconnecting procedure.

**Disconnecting The Jumper Cables**

- Disconnect the negative (-) end of the jumper cable from the remote negative post of the vehicle with the discharged battery.
- Disconnect the opposite end of the negative (-) jumper cable from the negative (-) post of the booster battery.
- Disconnect the positive (+) end of the jumper cable from the positive (+) post of the booster battery.
- Disconnect the opposite end of the positive (+) jumper cable from the positive (+) post of the vehicle with the discharged battery and reinstall the protective cap.

If frequent jump starting is required to start your vehicle you should have the battery and charging system inspected at an authorized dealer.

**CAUTION!**

The rear 12 Volt DC outlet is not controlled by the vehicle's ignition (the outlet provides power even when the ignition is OFF). Accessories (i.e., cellular devices, ect.) plugged into the rear 12 Volt power outlet may draw sufficient power, even when they are OFF (in standby mode), to discharge the vehicle's 12 Volt battery. If the device is allowed to continue drawing power, eventually the vehicle's 12 Volt battery will discharge sufficiently to degrade battery life and/or prevent the engine from starting.

**JUMP STARTING — HYBRID MODELS**

If your vehicle has a discharged battery it can be jump started using a set of jumper cables and a battery in another vehicle or by using a portable battery booster pack. Jump starting can be dangerous if done improperly so please follow the procedures in this section carefully.

**NOTE:**

When using a portable battery booster pack follow the manufacturer's operating instructions and precautions. The vehicle requires its 12 Volt battery power to turn-on the vehicle's high voltage battery. The high voltage battery is used to charge the 12 Volt battery, provide electric vehicle operation, and to start the vehicle's gas engine. If the 12 Volt battery has been discharged, the vehicle can be jump started using a set of jumper cables and a battery in another vehicle or by using a portable battery booster pack.

If the vehicle's high voltage battery has also been discharged, it will need to be recharged to a minimum operating State Of Charge (SOC) before the vehicle can be started:

- If the vehicle can be connected to a Level 1 or Level 2 charger where it is currently parked, the vehicle will still require a jump start to allow the vehicle to begin the battery charging process. Once the vehicle charging has begun (indicated by the charge status indicator on top of the vehicle's instrument panel), the jumper cables can be removed from the vehicle jump posts.
- If the vehicle cannot be connected to a Level 1 or Level 2 charger where it is currently parked, the vehicle can be moved by connecting 12 Volt power to the vehicle's jump posts and then shifting the transmission from PARK (P) into NEUTRAL (N). Power provided by the jumper cables will also allow the Electric Park Brake to be released. Carefully move the vehicle to a Level 1 or Level 2 charge location. While the vehicle is being moved, the external 12 Volt power must remain connected to the vehicle jump posts.

**NOTE:**

Be careful when moving the vehicle - ensure that control of the vehicle is maintained. Also, ensure that vehicle is secured to prevent unintentional movement during and after moving the vehicle. If the external 12 Volt power becomes disconnected from the vehicle jump posts or there is an interruption of the 12 Volt power while moving the vehicle, the vehicle's transmission may engage PARK. Do not allow the jumper cables to come in contact with each other or to the vehicle, this will result in a short.

When the vehicle is at the charging location, shift the transmission back to PARK, apply the Electric Park Brake, and start the high voltage battery charging. Once the vehicle has been secured against unintentional movement and high voltage battery charging has been initiated, the jumper cables can be removed from the vehicle jump posts.

Jump starting can be dangerous if done improperly so please follow the procedures in this section carefully.

#### NOTE:

When using a portable battery booster pack, follow the manufacturer's operating instructions and precautions.

#### WARNING!

Do not attempt jump starting if the battery is frozen. It could rupture or explode and cause personal injury.

#### CAUTION!

Do not use a portable battery booster pack or any other booster source with a system voltage greater than 12 Volts or damage to the battery, starter motor, alternator or electrical system may occur.

## PREPARATIONS FOR JUMP START — HYBRID MODELS

The battery in your vehicle is located on the driver's side of the engine compartment.

#### WARNING!

- Take care to avoid the radiator cooling fan whenever the hood is raised. It can start anytime the ignition switch is ON. You can be injured by moving fan blades.
- Remove any metal jewelry such as rings, watch bands and bracelets that could make an inadvertent electrical contact. You could be seriously injured.
- Batteries contain sulfuric acid that can burn your skin or eyes and generate hydrogen gas which is flammable and explosive. Keep open flames or sparks away from the battery.

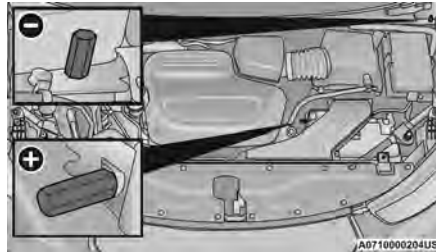

Battery Location

#### NOTE:

The positive battery post may be covered with a protective cap. Lift up on the cap to gain access to the positive battery post. Do not jump off fuses. Only jump directly off positive post which has a positive (+) symbol on or around the post.

See the following steps to prepare for jump starting:

1. Apply the parking brake, shift the automatic transmission into PARK (P) and place the ignition to OFF.
2. Turn off the heater, radio, and all electrical accessories.
3. Pull upward and remove the protective cap over the positive (+) battery post.
4. If using another vehicle to jump start the battery, park the vehicle within the jumper cable's reach, set the parking brake and make sure the ignition is OFF.

#### WARNING!

Do not allow vehicles to touch each other as this could establish a ground connection and personal injury could result.

## JUMP STARTING PROCEDURE — HYBRID MODELS

### WARNING!

Failure to follow this jump starting procedure could result in personal injury or property damage due to battery explosion.

### CAUTION!

Failure to follow these procedures could result in damage to the charging system of the booster vehicle or the discharged vehicle.

#### Connecting The Jumper Cables

1. Connect the positive (+) end of the jumper cable to the positive (+) post of the vehicle with the discharged battery.
2. Connect the opposite end of the positive (+) jumper cable to the positive (+) post of the booster battery.
3. Connect the negative (-) end of the jumper cable to the negative (-) post of the booster battery.
4. Connect the opposite end of the negative (-) jumper cable to the remote negative (-) post near the windshield cowl (exposed metallic/unpainted post of the discharge vehicle).

### WARNING!

Do not connect the jumper cable to the negative (-) post of the discharged battery. The resulting electrical spark could cause the battery to explode and could result in personal injury.

5. Start the engine in the vehicle that has the booster battery, let the engine idle a few minutes, and then cycle the ignition to ON/RUN in the vehicle with the discharged battery.
6. After a couple minutes (depending on the level of 12 Volt battery discharge), attempt to start the vehicle. Once the vehicle starts, follow the disconnecting procedure.

#### Disconnecting The Jumper Cables

1. Disconnect the negative (-) end of the jumper cable from the remote negative post of the vehicle with the discharged battery.
2. Disconnect the opposite end of the negative (-) jumper cable from the negative (-) post of the booster battery.
3. Disconnect the positive (+) end of the jumper cable from the positive (+) post of the booster battery.
4. Disconnect the opposite end of the positive (+) jumper cable from the positive (+) post of the vehicle with the discharged battery and reinstall the protective cap.

If frequent jump starting is required to start your vehicle you should have the battery and charging system inspected at an authorized dealer.

### CAUTION!

The rear 12 Volt DC outlet is not controlled by the vehicle's ignition (the outlet provides power even when the ignition is OFF). Accessories (i.e., cellular devices, ect.) plugged into the rear 12 Volt power outlet may draw sufficient power, even when they are OFF (in standby mode), to discharge the vehicle's 12 Volt battery. If the device is allowed to continue drawing power, eventually the vehicle's 12 Volt battery will discharge sufficiently to degrade battery life and/or prevent the engine from starting.

## REFUELING IN EMERGENCY — IF EQUIPPED

The vehicle is equipped with a refueling funnel for a capless fuel system. If emergency refueling is necessary, use an approved gas can and insert the refueling funnel into the fuel filler pipe opening. Take care to open both flappers with the funnel to avoid spills.

### NOTE:

In certain cold conditions, ice may prevent the fuel door from opening. If this occurs, lightly push on the fuel door to break the ice buildup and re-release the fuel door by pushing at the rear center edge to unlatch.



A0711000013US

### Refueling Funnel

#### Emergency Gas Can Refueling

Most gas cans will not open the flapper doors. A funnel is provided to allow emergency refueling with a gas can. See the following steps for refueling:

1. Retrieve funnel from the rear storage area.

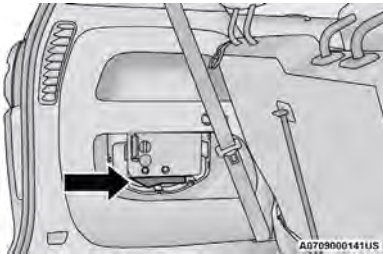

A0709000141US

### Fuel Funnel Location

2. Insert funnel into the fuel filler pipe opening.

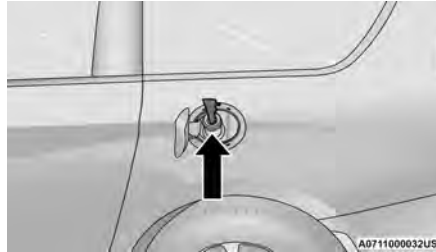

A0711000032US

### Inserting Funnel

3. Ensure funnel is inserted fully to hold flapper doors open.
4. Pour fuel into funnel opening.

### CAUTION!

To avoid fuel spillage and overfilling, do not "top off" the fuel tank after filling.

5. Remove funnel from filler pipe, clean off prior to putting back in the spare tire storage area.

### WARNING!

- Never have any smoking materials lit in or near the vehicle when the fuel door is open or the tank is being filled.
- Never add fuel when the engine is running. This is in violation of most state and federal fire regulations and may cause the Malfunction Indicator Light to turn on.

(Continued)

### WARNING!

- A fire may result if fuel is pumped into a portable container that is inside of a vehicle. You could be burned. Always place fuel containers on the ground while filling.

## IF YOUR ENGINE OVERHEATS

If the vehicle is overheating, it will need to be serviced by an authorized dealer.

Potential signs of vehicle overheating:

- Temperature gauge is at HOT (H)
- Strong smell of coolant
- White smoke coming from engine or exhaust
- Coolant bottle coolant has bubbles present

### WARNING!

You or others can be badly burned by hot engine coolant (antifreeze) or steam from your radiator. If you see or hear steam coming from under the hood, do not open the hood until the radiator has had time to cool. Never try to open a cooling system pressure cap when the radiator or coolant bottle is hot.

If the temperature gauge is moving towards or close to the HOT (H) position, you can reduce the potential for overheating by taking the appropriate action.

- On highways — slow down.
- In city traffic — while stopped, place the transmission in NEUTRAL (N), but do not increase the engine idle speed while preventing vehicle motion with the brakes.

- Turn off the Air Conditioner (A/C). The A/C system adds heat to the engine cooling system and turning the A/C off can help remove this heat.
- Turn the temperature control to maximum heat, the mode control to floor and the blower control to high. This allows the heater core to act as a supplement to the radiator and aids in removing heat from the engine cooling system.

**CAUTION!**

Driving with a hot cooling system could damage your vehicle. If temperature gauge reads "H", pull over and stop the vehicle. Idle the vehicle with the air conditioner turned off until the pointer drops back into the normal range. If the pointer remains on the "H", turn the engine off immediately, and call for service.

**MANUAL PARK RELEASE****WARNING!**

You should be seated in the driver's seat with your foot firmly placed on the brake pedal to maintain control of the vehicle before activating the Manual Park Release. If possible, you should apply the parking brake. Activating the Manual Park Release will allow your vehicle to roll away if it is not secured or properly connected to a tow vehicle. Activating the Manual Park Release on an unsecured vehicle could lead to serious injury or death for those in or around the vehicle.

To move the vehicle in cases where the transmission will not shift out of PARK (P) (such as a depleted battery), a Manual Park Release is available.

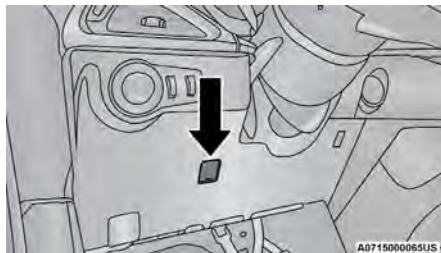
**Manual Park Release Access Cover****Follow These Steps To Activate The Manual Park Release:**

1. Apply firm pressure to the brake pedal while seated in the driver's seat.
2. Apply the parking brake, if possible.
3. Using a small screwdriver or similar tool, remove the Manual Park Release access cover, which is to the lower left of the steering column.
4. The Manual Park Release access cover is connected to a red tether strap. Pull the tether strap out as far as it will go, then release it. The transmission should now be in NEUTRAL (N), allowing the vehicle to be moved.

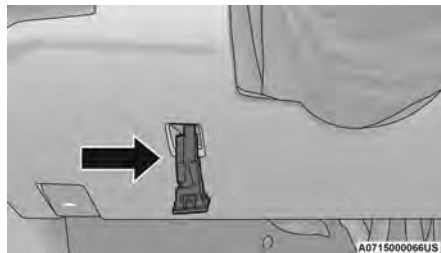
**Tether Strap****NOTE:**

When the lever is locked in the released position, the tether will remain outside of the trim panel and the access cover cannot be reinstalled.

5. Release the parking brake only when the vehicle is securely connected to a tow vehicle.

**To Reset The Manual Park Release:**

1. Apply firm pressure to the brake pedal while seated in the driver's seat.
2. Pull the tether strap out again, then release it.
3. Allow the tether to retract with the lever back to its original position.
4. Verify that the transmission is in PARK (P).
5. Confirm that the tether has retracted fully and reinstall the access cover. If the access cover cannot be reinstalled, repeat steps 1 through 4.

## FREEDING A STUCK VEHICLE

If your vehicle becomes stuck in mud, sand or snow, it can often be moved using a rocking motion. Turn the steering wheel right and left to clear the area around the front wheels. Then shift back and forth between DRIVE (D) and REVERSE (R) while gently pressing the accelerator.

### NOTE:

- Shifts between DRIVE and REVERSE can only be achieved at wheel speeds of 5 mph (8 km/h) or less. Whenever the transmission remains in NEUTRAL (N) for more than two seconds, you must press the brake pedal to engage DRIVE or REVERSE. Use the least amount of accelerator pedal pressure that will maintain the rocking motion without spinning the wheels or racing the engine.

- Push the ESC OFF button to place the Electronic Stability Control (ESC) system in "Partial Off" mode, before rocking the vehicle ⇄ page 196. Once the vehicle has been freed, push the ESC OFF button again to restore "ESC On" mode.

### WARNING!

Fast spinning tires can be dangerous. Forces generated by excessive wheel speeds may cause damage, or even failure, of the axle and tires. A tire could explode and injure someone. Do not spin your vehicle's wheels faster than 30 mph (48 km/h) or for longer than 30 seconds continuously without stopping when you are stuck and do not let anyone near a spinning wheel, no matter what the speed.

### CAUTION!

- Racing the engine or spinning the wheels may lead to transmission overheating and failure. Allow the engine to idle with the transmission in NEUTRAL for at least one minute after every five rocking-motion cycles. This will minimize overheating and reduce the risk of transmission failure during prolonged efforts to free a stuck vehicle.
- When "rocking" a stuck vehicle by shifting between DRIVE and REVERSE, do not spin the wheels faster than 15 mph (24 km/h), or drivetrain damage may result.
- Revving the engine or spinning the wheels too fast may lead to transmission overheating and failure. It can also damage the tires. Do not spin the wheels above 30 mph (48 km/h) while in gear (no transmission shifting occurring).

## TOWING A DISABLED VEHICLE

This section describes procedures for towing a disabled vehicle using a commercial towing service.

Towing Condition	Wheels OFF The Ground	FWD MODELS	AWD MODELS
Flat Tow	NONE	NOT ALLOWED	NOT ALLOWED
Wheel Lift Or Dolly Tow	Front	ACCEPTABLE METHOD	NOT ALLOWED
	Rear	NOT ALLOWED	NOT ALLOWED
Flatbed	ALL	BEST METHOD	BEST METHOD

Proper towing or lifting equipment is required to prevent damage to your vehicle. Use only tow bars and other equipment designed for this purpose, following equipment manufacturer's instructions. Use of safety chains is mandatory. Attach a tow bar or other towing device to main structural members of the vehicle, not to fascia/bumper or associated brackets. State and local laws regarding vehicles under tow must be observed.

**NOTE:**

- You must ensure that the Auto Park Brake feature is disabled before towing this vehicle (if rear wheels are on the ground), to avoid inadvertent Electric Park Brake (EPB) engagement. The Auto Park Brake feature is enabled or disabled via the customer programmable features in the Uconnect Settings.
- Vehicles with a discharged battery or total electrical failure when the EPB is engaged, will need a wheel dolly or jack to raise the rear wheels off the ground when moving the vehicle onto a flatbed.

FCA US LLC recommends towing your vehicle with all four wheels **OFF** the ground using a flatbed.

If flatbed equipment is not available, this vehicle must be towed with the front wheels **OFF** the ground (using a towing dolly, or wheel lift equipment with the front wheels raised).

**NOTE:**

Ensure that the Electric Park Brake is released, and remains released, while being towed.

**CAUTION!**

Towing this vehicle in violation of the approved requirements can cause severe transmission damage. Damage from improper towing is not covered under the New Vehicle Limited Warranty.

**Vehicle Recovery Tow Points**

Your vehicle is equipped with Vehicle Recovery Points that can be used to recover a disabled vehicle, located on the underbody of the vehicle.

**NOTE:**

- Ensure that the towing service tow hooks are properly seated and secured in the attachment points.
- This recovery tow feature should be used by a trained professional only.
- Use approved receptacle location to free the disabled vehicle from its environment.

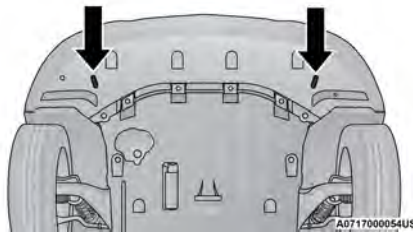
**Front Recovery Points****CAUTION!**

Recovery feature:

- Is to be used by a professional **ONLY**.
- Is used only to provide recovery of the vehicle.
- Is **NOT** to be used to recover secondary vehicle.
- Is **NOT** to be used for transporting the vehicle over the road, i.e. "Flat Towing".

(Continued)

**CAUTION!**

Recovery load should:

- Be applied at constant speed.
- Be applied parallel to the center line of the length of the vehicle.
- Not be an abrupt acceleration.

If you must use the accessories (wipers, defrosters, etc.) while being towed, the ignition must be in the ON/RUN mode, not the ACC mode.

**NOTE:**

The Safehold feature will engage the Electric Park Brake whenever the driver's door is opened (if the ignition is ON, transmission is not in PARK, and brake pedal is released). If you are towing this vehicle with the ignition in the ON/RUN mode, you must manually disable the Electric Park Brake each time the driver's door is opened, by pressing the brake pedal and then releasing the EPB.

If the key fob is unavailable or the vehicle's battery is discharged, detailed instructions on shifting the transmission out of PARK in order to move the vehicle → page 260.

**CAUTION!**

- Do not use sling-type equipment when towing. Vehicle damage may occur.
- When securing the vehicle to a flatbed truck, do not attach to front or rear suspension components. Damage to your vehicle may result from improper towing.
- Ensure that the Electric Park Brake is released, and remains released, while being towed.



## ALL WHEEL DRIVE (AWD) MODELS

FCA US LLC recommends towing your vehicle with all four wheels **OFF** the ground using a flatbed.

### CAUTION!

- Towing this vehicle using any other method can cause severe transmission and/or transfer case damage.
- Damage from improper towing is not covered under the New Vehicle Limited Warranty.

## ENHANCED ACCIDENT RESPONSE SYSTEM (EARS)

This vehicle is equipped with an Enhanced Accident Response System.

This feature is a communication network that takes effect in the event of an impact. Detailed information can be found on [↩](#) page 224.

## EVENT DATA RECORDER (EDR)

This vehicle is equipped with an Event Data Recorder (EDR). The main purpose of an EDR is to record data that will assist in understanding how a vehicle's systems performed under certain crash or near crash-like situations, such as an air bag deployment or hitting a road obstacle. Detailed information can be found on [↩](#) page 225.

# SERVICING AND MAINTENANCE

## SCHEDULED SERVICING

Your vehicle is equipped with an automatic oil change indicator system. The oil change indicator system will remind you that it is time to take your vehicle in for scheduled maintenance.

Based on engine operation conditions, the oil change indicator message will illuminate. This means that service is required for your vehicle. Operating conditions such as frequent short-trips, trailer towing, extremely hot or cold ambient temperatures will influence when the "Oil Change Required" message is displayed. Have your vehicle serviced as soon as possible, within the next 500 miles (805 km).

## MAINTENANCE PLAN

Refer to the Maintenance Plan for required maintenance.

An authorized dealer will reset the oil change indicator message after completing the scheduled oil change. If a scheduled oil change is performed by someone other than an authorized dealer → page 103.

### NOTE:

Under no circumstances should oil change intervals exceed 10,000 miles (16,000 km), 12 months or 350 hours of engine run time, whichever comes first. The 350 hours of engine run or idle time is generally only a concern for fleet customers.

### Once A Month Or Before A Long Trip:

- Check engine oil level.
- Check windshield washer fluid level.
- Check tire pressure and look for unusual wear or damage. Rotate tires at the first sign of irregular wear, even if it occurs before the oil indicator system turns on.
- Check the fluid levels of the coolant reservoir and brake master cylinder, fill as needed.
- Check function of all interior and exterior lights.

At Every Oil Change Interval As Indicated By Oil Change Indicator System
● Change oil and filter.
● Rotate the tires at the first sign of irregular wear, even if it occurs before the oil indicator system turns on.
● Inspect 12 Volt battery and clean and tighten terminals as required.
● Inspect the CV/Universal joints.
● Inspect brake pads, shoes, rotors, drums, hoses and parking brake.
● Inspect engine cooling system protection and hoses.
● Inspect exhaust system.
● Inspect engine air cleaner filter if using in dusty or off-road conditions. If required, replace engine air cleaner filter.

Mileage Or Time Passed (Whichever Comes First)	20,000	30,000	40,000	50,000	60,000	70,000	80,000	90,000	100,000	110,000	120,000	130,000	140,000	150,000
Or Years:	2	3	4	5	6	7	8	9	10	11	12	13	14	15
Or Kilometers:	32,000	48,000	64,000	80,000	96,000	112,000	128,000	144,000	160,000	176,000	192,000	208,000	224,000	240,000
<b>Additional Inspections</b>														
Inspect the CV/Universal joints	X	X	X	X	X	X	X	X	X	X	X	X	X	X
Inspect front suspension, boot seals, tie rod ends, and replace if necessary	X		X		X		X		X		X		X	
Inspect the brake linings, parking brake function	X		X		X		X		X		X		X	
Inspect front accessory drive tensioner, idler pulley, and replace if necessary														X
<b>Additional Maintenance</b>														
Replace engine air cleaner filter		X			X			X			X			X
Replace cabin air filter	To be replaced every 12,000 miles (19,000 km).													
Replace spark plugs**									X					
Replace the front accessory drive belt														X
Flush and replace the engine, power electronics, and battery coolant at 10 years or 150,000 miles (240,000 km) whichever comes first**									X					X
Replace PCV valve									X					

\*\* Some vehicles require special tools to add coolant properly. Failure to fill these systems properly could lead to severe internal damage. If any coolant needs to be added to the system please contact your local authorized dealer.

**WARNING!**

- You can be badly injured working on or around a motor vehicle. Do only service work for which you have the knowledge and the right equipment. If you have any doubt about your ability to perform a service job, take your vehicle to a competent mechanic.
- Failure to properly inspect and maintain your vehicle could result in a component malfunction and affect vehicle handling and performance. This could cause an accident.

## ENGINE COMPARTMENT

### 3.6L ENGINE

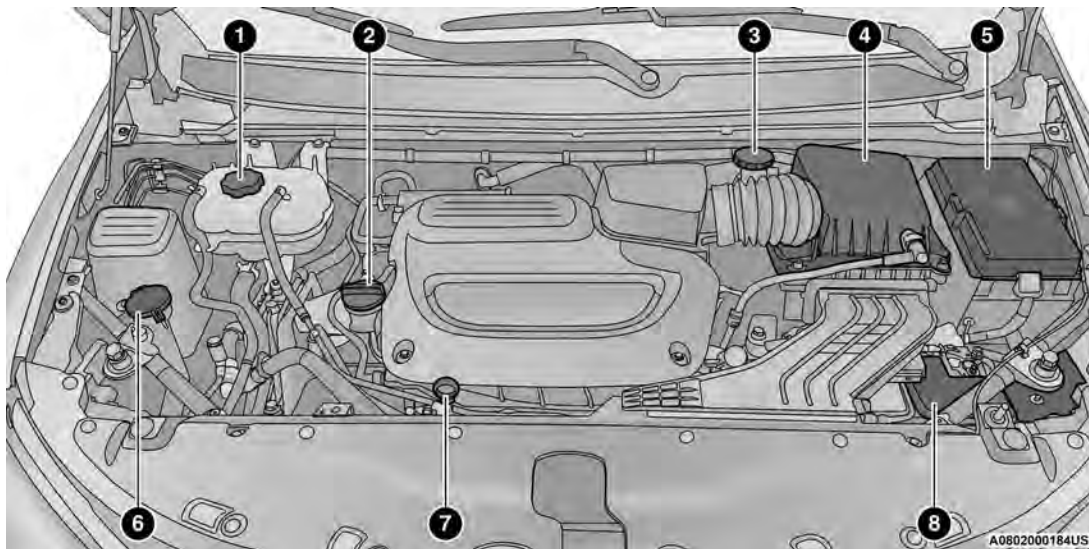

- 1 – Engine Coolant Pressure Cap
- 2 – Engine Oil Fill
- 3 – Brake Fluid Reservoir Cap
- 4 – Engine Air Cleaner, Filter

- 5 – Power Distribution Center (Fuses)
  - 6 – Windshield Washer Reservoir Cap
  - 7 – Engine Oil Dipstick
  - 8 – Battery
-

## ENGINE COMPARTMENT – HYBRID MODELS (IF EQUIPPED)

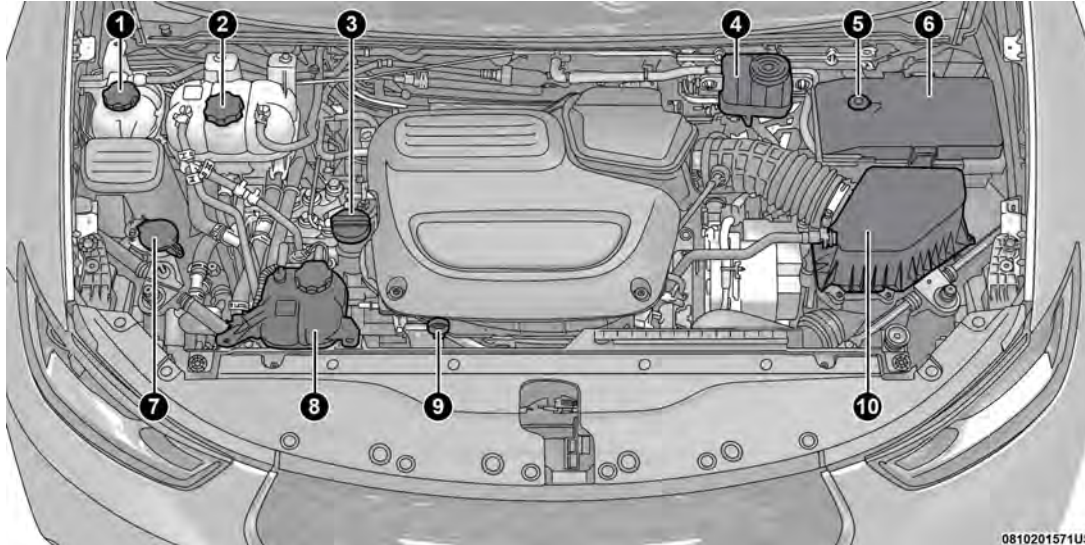

0810201571US

- 1 – Battery Coolant Reservoir<sup>1</sup>
- 2 – Engine Coolant Pressure Reservoir
- 3 – Engine Oil Fill
- 4 – Brake Fluid Reservoir
- 5 – Remote Jump Start Positive Terminal

- 6 – Power Distribution Center (Fuses)
- 7 – Washer Fluid Reservoir Cap
- 8 – Power Electronics Coolant Reservoir<sup>1</sup>
- 9 – Engine Oil Dipstick
- 10 – Engine Air Cleaner, Filter

<sup>1</sup> See an authorized dealer for service.

## CHECKING OIL LEVEL

To ensure proper engine lubrication, the engine oil must be maintained at the correct level. Check the oil level at regular intervals, such as every fuel stop. The best time to check the engine oil level is about five minutes after a fully warmed up engine is shut off.

Checking the oil while the vehicle is on level ground will improve the accuracy of the oil level readings.

There are four possible dipstick types:

- Crosshatched zone.
- Crosshatched zone marked SAFE.
- Crosshatched zone marked with MIN at the low end of the range and MAX at the high end of the range.
- Crosshatched zone marked with dimples at the MIN and the MAX ends of the range.

### NOTE:

Always maintain the oil level within the crosshatch markings on the dipstick.

Adding 1 qt (1 L) of oil when the reading is at the low end of the dipstick range will raise the oil level to the high end of the range marking.

### CAUTION!

Overfilling or underfilling the crankcase will cause aeration or loss of oil pressure. This could damage your engine.

## ADDING WASHER FLUID

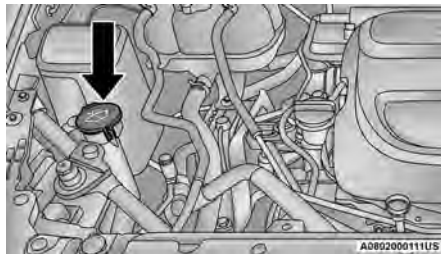

**Windshield Washer Fluid Cap**

The fluid reservoir is located in the front of the engine compartment. Be sure to check the fluid level in the reservoir at regular intervals. Fill the reservoir with windshield washer solvent (not radiator antifreeze) and operate the system for a few seconds to flush out the residual washer fluid.

When refilling the washer fluid reservoir, take some washer fluid, apply it to a cloth or towel, and wipe clean the wiper blades; this will help blade performance.

To prevent freeze-up of your windshield washer system in cold weather, select a solution or mixture that meets or exceeds the temperature range of your climate. This rating information can be found on most washer fluid containers.

### WARNING!

Commercially available windshield washer solvents are flammable. They could ignite and burn you. Care must be exercised when filling or working around the washer solution.

## MAINTENANCE-FREE BATTERY

Your vehicle is equipped with a maintenance-free battery. You will never have to add water, and periodic maintenance is not required.

### WARNING!

- Battery fluid is a corrosive acid solution and can burn or even blind you. Do not allow battery fluid to contact your eyes, skin, or clothing. Do not lean over a battery when attaching clamps. If acid splashes in eyes or on skin, flush the area immediately with large amounts of water → page 254.
- Battery gas is flammable and explosive. Keep flame or sparks away from the battery. Do not use a booster battery or any other booster source with an output greater than 12 Volts. Do not allow cable clamps to touch each other.
- Battery posts, terminals, and related accessories contain lead and lead compounds. Wash hands after handling.

**CAUTION!**

- It is essential when replacing the cables on the battery that the positive cable is attached to the positive post and the negative cable is attached to the negative post. Battery posts are marked positive (+) and negative (-) and are identified on the battery case. Cable clamps should be tight on the terminal posts and free of corrosion.
- If a "fast charger" is used while the battery is in the vehicle, disconnect both vehicle battery cables before connecting the charger to the battery. Do not use a "fast charger" to provide starting voltage.

**PRESSURE WASHING**

Cleaning the engine compartment with a high pressure washer is not recommended.

**CAUTION!**

Precautions have been taken to safeguard all parts and connections however, the pressures generated by these machines is such that complete protection against water ingress cannot be guaranteed.

**VEHICLE MAINTENANCE**

An authorized dealer has the qualified service personnel, special tools, and equipment to perform all service operations in an expert manner. Service Manuals are available which include detailed service information for your vehicle. Refer to these Service Manuals before attempting any procedure yourself.

**NOTE:**

Intentional tampering with emissions control systems may void your warranty and could result in civil penalties being assessed against you.

**WARNING!**

You can be badly injured working on or around a motor vehicle. Only do service work for which you have the knowledge and the proper equipment. If you have any doubt about your ability to perform a service job, take your vehicle to a competent mechanic.

**ENGINE OIL****Engine Oil Selection**

Use only the manufacturer's recommended fluids  
 ⇨ page 313.

**American Petroleum Institute (API)  
Approved Engine Oil**

These symbols mean that the oil has been certified by the API. The manufacturer only recommends API trademark oils.



The API Starburst trademark certifies 0W-20, 0W-30 and 5W-30 engine oils.



The API Donut trademark certifies 0W-40 and 5W-40 engine oil.

**CAUTION!**

Do not use chemical flushes in your engine oil as the chemicals can damage your engine. Such damage is not covered by the New Vehicle Limited Warranty.

**Synthetic Engine Oils**

Your engine was designed for synthetic engine oils, only use synthetic API approved engine oils.

Synthetic engine oils which do not have both the correct API trademark and the correct SAE viscosity grade numbers should not be used.

**Materials Added To Engine Oil**

The manufacturer strongly recommends against the addition of any additives (other than leak detection dyes) to the engine oil. Engine oil is an engineered product and its performance may be impaired by supplemental additives.

**Disposing Of Used Engine Oil And Oil Filters**

Care should be taken in disposing of used engine oil and oil filters from your vehicle. Used oil and oil filters, indiscriminately discarded, can present a problem to the environment. Contact an authorized dealer, service station or governmental agency for advice on how and where used oil and oil filters can be safely discarded in your area.

## ENGINE OIL FILTER

The engine oil filter should be replaced with a new filter at every engine oil change.

### Engine Oil Filter Selection

A full-flow type disposable oil filter should be used for replacement. The quality of replacement filters varies considerably. Only high quality Mopar® certified filters should be used. If Mopar® Engine Oil Filters are unavailable only use filters that meet or exceed SAE/USCAR-36 Filter Performance Requirements.

## ENGINE AIR CLEANER FILTER

For the proper maintenance intervals ↪ page 264.

### WARNING!

The air induction system (air cleaner, hoses, etc.) can provide a measure of protection in the case of engine backfire. Do not remove the air induction system (air cleaner, hoses, etc.) unless such removal is necessary for repair or maintenance. Make sure that no one is near the engine compartment before starting the vehicle with the air induction system (air cleaner, hoses, etc.) removed. Failure to do so can result in serious personal injury.

### Engine Air Cleaner Filter Selection

The quality of replacement filters varies considerably. Only high quality Mopar® certified filters should be used.

## ACCESSORY DRIVE BELT INSPECTION

### WARNING!

- Do not attempt to inspect an accessory drive belt with vehicle running.
- When working near the radiator cooling fan, disconnect the fan motor lead. The fan is temperature controlled and can start at any time regardless of ignition mode. You could be injured by the moving fan blades.
- You can be badly injured working on or around a motor vehicle. Only do service work for which you have the knowledge and the proper equipment. If you have any doubt about your ability to perform a service job, take your vehicle to a competent mechanic.

When inspecting accessory drive belts, small cracks that run across the ribbed surface of a belt from rib to rib, are considered normal. These are not a reason to replace belt. However, cracks running along a rib (not across) are not normal. Any belt with cracks running along a rib must be replaced. Also, have the belt replaced if it has excessive wear, frayed cords, or severe glazing.

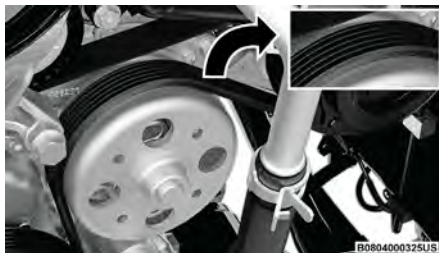

**Accessory Belt (Serpentine Belt)**

Conditions that would require replacement:

- Rib chunking (one or more ribs has separated from belt body)
- Rib or belt wear
- Longitudinal belt cracking (cracks between two ribs)
- Belt slips
- Groove jumping (belt does not maintain correct position on pulley)
- Belt broken

### NOTE:

Identify and correct problem before new belt is installed

- Noise (objectionable squeal, squeak, or rumble is heard or felt while drive belt is in operation).

Some conditions can be caused by a faulty component such as a belt pulley. Belt pulleys should be carefully inspected for damage and proper alignment.

Belt replacement on some models requires the use of special tools; we recommend having your vehicle serviced at an authorized dealer.



## AIR CONDITIONER MAINTENANCE

For best possible performance, your air conditioner should be checked and serviced by an authorized dealer at the start of each warm season. This service should include cleaning of the condenser fins and a performance test. Drive belt tension should also be checked at this time.

### WARNING!

- Use only refrigerants and compressor lubricants approved by the manufacturer for your air conditioning system. Some unapproved refrigerants are flammable and can explode, injuring you. Other unapproved refrigerants or lubricants can cause the system to fail, requiring costly repairs. Refer to Warranty Information located online, for further warranty information.
- The air conditioning system contains refrigerant under high pressure. To avoid risk of personal injury or damage to the system, adding refrigerant or any repair requiring lines to be disconnected should be done by an experienced technician.

### CAUTION!

Do not use chemical flushes in your air conditioning system as the chemicals can damage your air conditioning components. Such damage is not covered by the New Vehicle Limited Warranty.

## Refrigerant Recovery And Recycling — R-1234yf

R-1234yf Air Conditioning Refrigerant is a Hydrofluorolefin (HFO) that is endorsed by the Environmental Protection Agency and is an ozone-friendly substance with a low global-warming potential. It is recommended that air conditioning service be performed by an authorized dealer using recovery and recycling equipment.

### NOTE:

Use only manufacturer approved A/C system PAG compressor oil, and refrigerants.

## Cabin Air Filter

### WARNING!

Do not remove the cabin air filter while the vehicle is running, or while the ignition is in the ACC or ON/RUN mode. With the cabin air filter removed and the blower operating, the blower can contact hands and may propel dirt and debris into your eyes, resulting in personal injury.

The cabin air filter is located in the fresh air inlet behind the glove compartment. Perform the following procedure to replace the filter:

1. Remove all contents from the glove compartment.

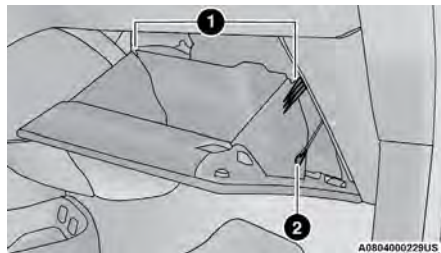

### Glove Compartment

- 1 — Glove Compartment Travel Stops
- 2 — Glove Compartment Tension Tether Clip

2. Open the glove compartment door partially, leaving extra slack on the glove compartment tension tether. Detach the glove compartment tension tether by sliding the black tension tether clip down, and popping it out of the slot on the side of the glove compartment door.
3. There are glove compartment travel stops on either side of the glove compartment door. To release them, push inward on each travel stop, and pull the glove compartment door down until the travel stops pass clear of their hooking points.

- Open the glove compartment door as far as possible to gain access to the cabin air filter compartment cover.

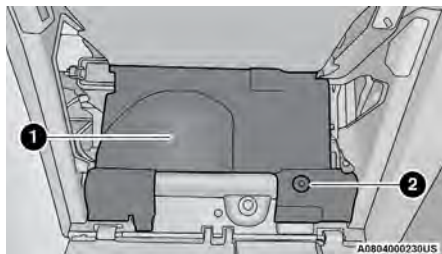

**Cabin Air Filter Compartment Cover**

- 1 — Compartment Cover  
2 — Compartment Snap

- Pry up the lid of each individual compartment snap, and detach it from the rest of the snap. There is a small space on the side of each snap to use for separating the lid from the snap. Once detached, remove the rest of the snap completely from the compartment cover.
- After removing the snaps, lift up the compartment cover to gain access to the fresh air inlet.

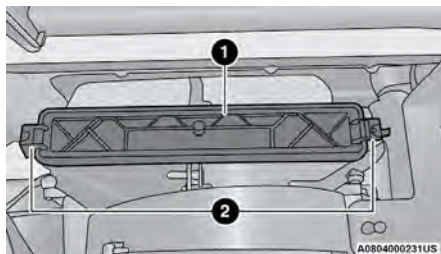

**Fresh Air Inlet**

- 1 — Filter Cover  
2 — Retaining Tabs

- Remove the filter cover by prying back each of the retaining tabs from their hooking points, and then pulling the filter cover out to expose the cabin air filter. Remove the air filter by pulling it straight out of the housing.
- Install the new air filter with the arrow on the filter pointing toward the floor.

#### **CAUTION!**

The cabin air filter is identified with an arrow to indicate airflow direction through the filter. Failure to properly install the filter will result in the need to replace it more often.

- Once the filter is replaced, reinstall the filter cover, making sure the retaining tabs are fully secured into their housings.
- Close the cabin air filter compartment cover, and reinsert the snaps into their slots. Push the snap lids until fully attached.
- Push the glove compartment door to the near closed position to reengage the glove compartment travel stops. Finally, pull the glove compartment tension tether clip down and slide it back into the slot on the side of the glove compartment door.

## **BODY LUBRICATION**

Locks and all body pivot points, including such items as seat tracks, door hinge pivot points and rollers, liftgate, tailgate, decklid, sliding doors and hood hinges, should be lubricated periodically. Use a lithium-based grease, such as Mopar® Spray White Lube to ensure quiet, easy operation and to protect against rust and wear. Prior to the application of any lubricant, the parts concerned should be wiped clean to remove dust and grit; after lubricating, excess oil and grease should be removed. Particular attention should also be given to hood latching components to ensure proper function. When performing other underhood services, the hood latch release mechanism, and safety catch should be cleaned and lubricated.

The external lock cylinders should be lubricated twice a year, preferably in the Autumn and Spring. Apply a small amount of a high quality lubricant, such as Mopar® Lock Cylinder Lubricant directly into the lock cylinder.

## WINDSHIELD WIPER BLADES

Clean the rubber edges of the wiper blades and the windshield periodically with a sponge or soft cloth and a mild nonabrasive cleaner. This will remove accumulations of salt or road film.

Operation of the wipers on dry glass for long periods may cause deterioration of the wiper blades. Always use washer fluid when using the wipers to remove salt or dirt from a dry windshield.

Avoid using the wiper blades to remove frost or ice from the windshield. Keep the blade rubber out of contact with petroleum products such as engine oil, gasoline, etc.

### NOTE:

Life expectancy of wiper blades varies depending on geographical area and frequency of use. If chattering, marks, water lines or wet spots are present, clean the wiper blades or replace as necessary.

The wiper blades and wiper arms should be inspected periodically, not just when wiper performance problems are experienced. This inspection should include the following points:

- Wear or uneven edges
- Foreign material
- Hardening or cracking
- Deformation or fatigue

If a wiper blade or wiper arm is damaged, replace the affected wiper arm or blade with a new unit. Do not attempt to repair a wiper arm or blade that is damaged.

## Front Wiper Blade Removal/Installation

### CAUTION!

Do not allow the wiper arm to spring back against the glass without the wiper blade in place or the glass may be damaged.

1. Lift the wiper arm to raise the wiper blade off of the glass, until the wiper arm is in the full up position.

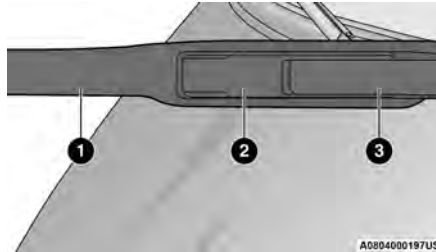

**Wiper Blade With Release Tab In Locked Position**

- 1 – Wiper Blade
- 2 – Release Tab
- 3 – Wiper Arm

2. To disengage the wiper blade from the wiper arm, flip up the release tab on the wiper blade and while holding the wiper arm with one hand, slide the wiper blade down towards the base of the wiper arm.

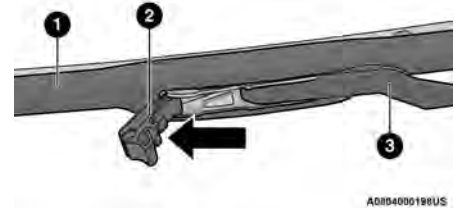

**Wiper Blade With Release Tab In Unlocked Position**

- 1 – Wiper Blade
- 2 – Release Tab
- 3 – Wiper Arm

3. With the wiper blade disengaged, remove the wiper blade from the wiper arm by holding the wiper arm with one hand and separating the wiper blade from the wiper arm with the other hand (move the wiper blade toward the right side of the vehicle to separate the wiper blade from the wiper arm).

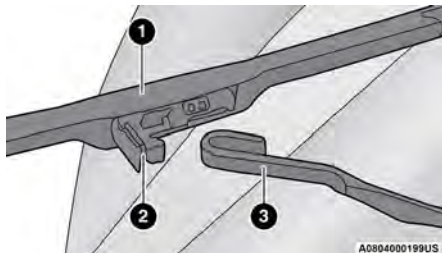
**Wiper Blade Removed From Wiper Arm**

- 1 – Wiper Blade
- 2 – Release Tab
- 3 – Wiper Arm

4. Gently lower the wiper arm onto the glass.

**Installing The Front Wipers**

1. Lift the wiper arm off of the glass, until the wiper arm is in the full up position.
2. Position the wiper blade near the hook on the tip of the wiper arm with the wiper release tab open and the blade side of the wiper facing up and away from the windshield.
3. Insert the hook on the tip of the arm through the opening in the wiper blade under the release tab.
4. Slide the wiper blade up into the hook on the wiper arm and rotate the wiper blade until it is flush against the wiper arm. Fold down the latch release tab and snap it into its locked position. Latch engagement will be accompanied by an audible click.
5. Gently lower the wiper blade onto the glass.

**Rear Wiper Blade Removal/Installation**

1. Lift the rear wiper arm pivot cap away from the glass to allow the rear wiper blade to be raised off of the glass.

**NOTE:**

The rear wiper arm cannot be fully raised off the glass unless the wiper arm pivot cap is unsnapped first. Attempting to fully raise the rear wiper arm without unsnapping the wiper arm pivot cap may damage the vehicle.

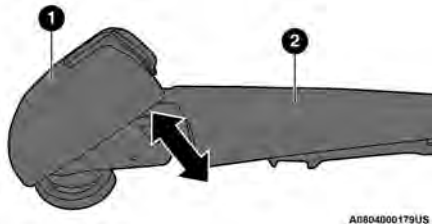
**Wiper Pivot Cap In Unlocked Position**

- 1 – Wiper Arm Pivot Cap
- 2 – Wiper Arm

2. Lift the rear wiper arm fully off the glass.

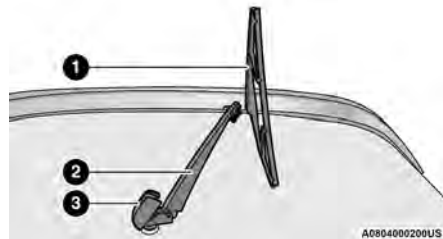
**Wiper Blade In Folded Out Position**

- 1 – Wiper Blade
- 2 – Wiper Arm
- 3 – Wiper Arm Pivot Cap

3. To remove the wiper blade from the wiper arm, grasp the bottom end of the wiper blade nearest to wiper arm with your right hand. With your left hand hold the wiper arm as you pull the wiper blade away from the wiper arm past its stop far enough to unsnap the wiper blade pivot pin from the receptacle on the end of the wiper arm.

**NOTE:**

Resistance will be accompanied by an audible snap.

4. Still grasping the bottom end of the wiper blade, move the wiper blade upward and away from the wiper arm to disengage.

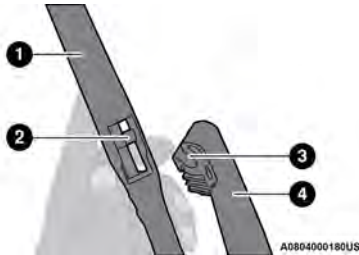

**Wiper Blade Removed From Wiper Arm**

- 1 — Wiper Blade
- 2 — Wiper Blade Pivot Pin
- 3 — Wiper Arm Receptacle
- 4 — Wiper Arm

5. Gently lower the tip of the wiper arm onto the glass.

#### Installing The Rear Wiper

1. Lift the rear wiper arm pivot cap away from the glass to allow the rear wiper blade to be raised off of the glass.

#### NOTE:

The rear wiper arm cannot be fully raised off the glass unless the wiper arm pivot cap is unsnapped first. Attempting to fully raise the rear wiper arm without unsnapping the wiper arm pivot cap may damage the vehicle.

2. Lift the rear wiper arm fully off the glass.

3. Insert the wiper blade pivot pin into the opening on the end of the wiper arm. Grab the bottom end of the wiper arm with one hand, and press the wiper blade flush with the wiper arm until it snaps into place.
4. Lower the wiper blade onto the glass and snap the wiper arm pivot cap back into place.

## EXHAUST SYSTEM

The best protection against carbon monoxide entry into the vehicle body is a properly maintained engine exhaust system.

If you notice a change in the sound of the exhaust system; or if exhaust fumes can be detected inside the vehicle; or when the underside or rear of the vehicle is damaged; have an authorized technician inspect the complete exhaust system and adjacent body areas for broken, damaged, deteriorated, or mispositioned parts. Open seams or loose connections could permit exhaust fumes to seep into the passenger compartment. In addition, have the exhaust system inspected each time the vehicle is raised for lubrication or oil changes. Replace as required.

### WARNING!

- Exhaust gases can injure or kill. They contain carbon monoxide (CO), which is colorless and odorless. Breathing it can make you unconscious and can eventually poison you → page 238.
- A hot exhaust system can start a fire if you park over materials that can burn, such as grass or leaves, and those items can come into contact with your exhaust system. Do not park or operate your vehicle in areas where your exhaust system can contact anything that can burn.

### CAUTION!

- The catalytic converter requires the use of unleaded fuel only. Leaded gasoline will destroy the effectiveness of the catalyst as an emissions control device and may seriously reduce engine performance and cause serious damage to the engine.
- Damage to the catalytic converter can result if your vehicle is not kept in proper operating condition. In the event of engine malfunction, particularly involving engine misfire or other apparent loss of performance, have your vehicle serviced promptly. Continued operation of your vehicle with a severe malfunction could cause the converter to overheat, resulting in possible damage to the converter and vehicle.

Under normal operating conditions, the catalytic converter will not require maintenance. However, it is important to keep the engine properly tuned to ensure proper catalyst operation and prevent possible catalyst damage.

### NOTE:

Intentional tampering with emissions control systems can result in civil penalties being assessed against you. In unusual situations involving grossly malfunctioning engine operation, a scorching odor may suggest severe and abnormal catalyst overheating. If this occurs, stop the vehicle, turn off the engine and allow it to cool. Service, including a tune-up to the manufacturer specifications, should be obtained immediately.

To minimize the possibility of catalytic converter damage:

- Do not interrupt the ignition when the transmission is in gear and the vehicle is in motion.
- Do not try to start the vehicle by pushing or towing the vehicle.
- Do not idle the engine with any ignition components disconnected or removed, such as during diagnostic testing, or for prolonged periods during very rough idle or malfunctioning operating conditions.

## COOLING SYSTEM

### WARNING!

- You or others can be badly burned by hot engine coolant (antifreeze) or steam from your radiator. If you see or hear steam coming from under the hood, do not open the hood until the radiator has had time to cool. Never open a cooling system pressure cap when the radiator or coolant bottle is hot.
- Keep hands, tools, clothing, and jewelry away from the radiator cooling fan when the hood is raised. The fan starts automatically and may start at any time, whether the engine is running or not.
- When working near the radiator cooling fan, disconnect the fan motor lead or turn the ignition to the OFF mode. The fan is temperature controlled and can start at any time the ignition is in the ON mode.

## Engine Coolant Checks

Check the engine coolant (antifreeze) protection every 12 months (before the onset of freezing weather, where applicable). If the engine coolant is dirty, the system should be drained, flushed, and refilled with fresh Organic Additive Technology (OAT) coolant (conforming to MS.90032) by an authorized dealer. Check the front of the A/C condenser for any accumulation of bugs, leaves, etc. If dirty, clean by gently spraying water from a garden hose vertically down the face of the condenser.

Check the engine cooling system hoses for brittle rubber, cracking, tears, cuts, and tightness of the connection at the coolant recovery bottle and radiator. Inspect the entire system for leaks. **DO NOT REMOVE THE COOLANT PRESSURE CAP WHEN THE COOLING SYSTEM IS HOT.**

## Cooling System — Drain, Flush And Refill

### NOTE:

Some vehicles require special tools to add coolant properly. Failure to fill these systems properly could lead to severe internal engine damage. If any coolant is needed to be added to the system please contact an authorized dealer.

If the engine coolant (antifreeze) is dirty or contains visible sediment, have an authorized dealer clean and flush with Organic Additive Technology (OAT) coolant (conforming to MS.90032).

For the proper maintenance intervals ⇨ page 264.

## Selection Of Coolant

For further information ⇨ page 313.

### NOTE:

- Mixing of engine coolant (antifreeze) other than specified Organic Additive Technology (OAT) engine coolant, may result in engine damage and may decrease corrosion protection. OAT engine coolant is different and should not be mixed with Hybrid Organic Additive Technology (HOAT) engine coolant or any “globally compatible” coolant. If a non-OAT engine coolant is introduced into the cooling system in an emergency, the cooling system will need to be drained, flushed, and refilled with fresh OAT coolant (conforming to MS.90032), by an authorized dealer as soon as possible.
- Do not use water alone or alcohol-based engine coolant products. Do not use additional rust inhibitors or anti-rust products, as they may not be compatible with the radiator engine coolant and may plug the radiator.
- This vehicle has not been designed for use with propylene glycol-based engine coolant. Use of propylene glycol-based engine coolant is not recommended.
- Some vehicles require special tools to add coolant properly. Failure to fill these systems properly could lead to severe internal engine damage. If any coolant is needed to be added to the system please contact an authorized dealer.

## Adding Coolant

Your vehicle has been built with an improved engine coolant (OAT coolant conforming to MS.90032) that allows extended maintenance intervals. This engine coolant (antifreeze) can be used up to ten years or 150,000 miles (240,000 km) before replacement. To prevent reducing this extended maintenance period, it is important that you use the same engine coolant (OAT coolant conforming to MS.90032) throughout the life of your vehicle.

Please review these recommendations for using OAT engine coolant that meets the requirements of the manufacturer Material Standard MS.90032. When adding engine coolant:

- We recommend using Mopar® Antifreeze/Coolant 10 Year/150,000 Mile (240,000 km) Formula OAT that meets the requirements of the manufacturer Material Standard MS.90032.
- Mix a minimum solution of 50% OAT engine coolant that meets the requirements of the manufacturer Material Standard MS.90032 and distilled water. Use higher concentrations (not to exceed 70%) if temperatures below  $-34^{\circ}\text{F}$  ( $-37^{\circ}\text{C}$ ) are anticipated. Please contact an authorized dealer for assistance.
- Use only high purity water such as distilled or deionized water when mixing the water/engine coolant solution. The use of lower quality water will reduce the amount of corrosion protection in the engine cooling system.

### NOTE:

- It is the owner's responsibility to maintain the proper level of protection against freezing according to the temperatures occurring in the area where the vehicle is operated.

- Some vehicles require special tools to add coolant properly. Failure to fill these systems properly could lead to severe internal engine damage. If any coolant is needed to be added to the system, please contact an authorized dealer.
- Mixing engine coolant types is not recommended and can result in cooling system damage. If HOAT and OAT coolant are mixed in an emergency, have an authorized dealer drain, flush, and refill with OAT coolant (conforming to MS.90032) as soon as possible.

## Cooling System Pressure Cap

The cap must be fully tightened to prevent loss of engine coolant (antifreeze), and to ensure that engine coolant will return to the radiator from the coolant expansion bottle/recovery tank (if equipped).

The cap should be inspected and cleaned if there is any accumulation of foreign material on the sealing surfaces.

### WARNING!

- Do not open a hot engine cooling system. Never add engine coolant (antifreeze) when the engine is overheated. Do not loosen or remove the cap to cool an overheated engine. Heat causes pressure to build-up in the cooling system. To prevent scalding or injury, do not remove the pressure cap while the system is hot or under pressure.
- Do not use a pressure cap other than the one specified for your vehicle. Personal injury or engine damage may result.

## Disposal Of Used Coolant

Used ethylene glycol-based coolant (antifreeze) is a regulated substance requiring proper disposal. Check with your local authorities to determine the disposal rules for your community. To prevent ingestion by animals or children, do not store ethylene glycol-based coolant in open containers or allow it to remain in puddles on the ground. If ingested by a child or pet, seek emergency assistance immediately. Clean up any ground spills immediately.

## Coolant Level

The coolant expansion bottle provides a quick visual method for determining that the coolant level is adequate. With the engine off and cold, the level of the coolant (antifreeze) in the bottle should be between the "MAX" and "MIN" lines marked on the bottle.

As long as the engine operating temperature is satisfactory, the coolant bottle need only be checked once a month.

When additional coolant is needed to maintain the proper level, it should be added to the coolant bottle. Do not overfill.

See an authorized dealer for service.

## Cooling System Notes

### NOTE:

When the vehicle is stopped after a few miles/kilometers of operation, you may observe vapor coming from the front of the engine compartment. This is normally a result of moisture from rain, snow, or high humidity accumulating on the radiator and being vaporized when the thermostat opens, allowing hot engine coolant (antifreeze) to enter the radiator.

If an examination of your engine compartment shows no evidence of radiator or hose leaks, the vehicle may be safely driven. The vapor will soon dissipate.

- Do not overfill the coolant expansion bottle.
- Check the coolant freeze point in the radiator and in the coolant expansion bottle. If engine coolant needs to be added, the contents of the coolant expansion bottle must also be protected against freezing.
- If frequent engine coolant additions are required, the cooling system should be pressure tested for leaks.
- Maintain engine coolant concentration at a minimum of 50% OAT coolant (conforming to MS.90032) and distilled water for proper corrosion protection of your engine which contains aluminum components.
- Make sure that the coolant expansion bottle overflow hoses are not kinked or obstructed.
- Keep the front of the radiator clean. If your vehicle is equipped with air conditioning, keep the front of the condenser clean.
- Do not change the thermostat for Summer or Winter operation. If replacement is ever necessary, install **ONLY** the correct type thermostat. Other designs may result in unsatisfactory engine cooling performance, poor gas mileage, and increased emissions.

## COOLING SYSTEM — HYBRID MODELS (IF EQUIPPED)

### WARNING!

- Turn vehicle off and disconnect the fan motor lead before working near the radiator cooling fan.
- You or others can be badly burned by hot engine coolant (antifreeze) or steam from your radiator. If you see or hear steam coming from under the hood, do not open the hood until the radiator has had time to cool. Never open a cooling system pressure cap when the radiator or coolant bottle is hot.
- Do not put your hands, tools, clothing, and jewelry near the radiator cooling fan. The fan may start at any time, whether the ignition is on or off.



08041138061J3

Cooling Fan Warning Label

This vehicle is equipped with an electric cooling fan mounted behind the radiator that starts automatically, and may start at any time. Your vehicle may determine the fan needs to start and to run if vehicle coolant is too hot, or if the ambient air temperature is too high. Even after the vehicle is turned off, the fan may start without warning and run for several minutes. Be aware of this if you are working in the engine compartment. Always keep fingers and tools away from the fan blades. The radiator fan and surrounding components must be serviced by an authorized dealer.

### Engine Coolant Checks

Check the engine coolant (antifreeze) every 12 months (before the onset of freezing weather, where applicable). If the engine coolant is dirty, the system should be drained, flushed, and refilled with fresh Organic Additive Technology (OAT) coolant (conforming to MS.90032) by an authorized dealer. Check the front of the A/C condenser for any accumulation of bugs, leaves, etc. If dirty, clean by gently spraying water from a garden hose vertically down the face of the condenser.

#### NOTE:

If the engine coolant is changed for low temperature capability, you must also change the coolant for the Electric/Battery systems ↪ page 279.

Check the engine cooling system hoses for brittle rubber, cracking, tears, cuts, and tightness of the connection at the coolant recovery bottle and radiator. Inspect the entire system for leaks. **DO NOT REMOVE THE COOLANT PRESSURE CAP WHEN THE COOLING SYSTEM IS HOT.**



## Cooling System — Drain, Flush And Refill

### NOTE:

Some vehicles require special tools to add coolant properly. Failure to fill these systems properly could lead to severe internal engine or electrical system damage. If any coolant is needed to be added to the system please contact an authorized dealer.

If the engine coolant (antifreeze) is dirty or contains visible sediment, have an authorized dealer clean and flush with Organic Additive Technology (OAT) coolant (conforming to MS.90032).

For the proper maintenance intervals ⇨ page 264.

## Electric/Battery Coolant System

These coolant systems must be serviced by an authorized dealer. If the coolant level is below what is specified on the reservoir, contact an authorized dealer for service.

These systems require the use of high purity water, such as deionized, or distilled water, when mixing the water and coolant (antifreeze) solution. The use of lower quality water will reduce the amount of corrosion protection in the cooling systems. If the coolant level of the battery coolant system is low, the Hybrid Electric Vehicle System Service Light will be illuminated on the instrument cluster.

## Selection Of Coolant

### NOTE:

- Mixing of engine coolant (antifreeze) other than specified Organic Additive Technology (OAT) engine coolant, may result in engine damage and may decrease corrosion protection. OAT engine coolant is different and should not be mixed with Hybrid Organic Additive Technology (HOAT) engine coolant or any “globally compatible” coolant. If a non-OAT engine coolant is introduced into the cooling system in an emergency, the cooling system will need to be drained, flushed, and refilled with fresh OAT coolant (conforming to MS.90032), by an authorized dealer as soon as possible.
- Do not use water alone or alcohol-based engine coolant products. Do not use additional rust inhibitors or antirust products, as they may not be compatible with the radiator engine coolant and may plug the radiator.
- This vehicle has not been designed for use with propylene glycol-based engine coolant. Use of propylene glycol-based engine coolant is not recommended.
- Some vehicles require special tools to add coolant properly. Failure to fill these systems properly could lead to severe internal engine damage. If any coolant is needed to be added to the system please contact an authorized dealer.

## Adding Coolant

Your vehicle has been built with an improved coolant (OAT coolant conforming to MS.90032) that allows extended maintenance intervals. This coolant (antifreeze) can be used up to ten years or 150,000 miles (240,000 km) before replacement. To prevent reducing this extended maintenance period, it is important that you use the same coolant (OAT coolant conforming to MS.90032) throughout the life of your vehicle.

Please review these recommendations for using Organic Additive Technology (OAT) coolant that meets the requirements of the manufacturer Material Standard MS.90032. When adding coolant:

- We recommend using Mopar® Antifreeze/Coolant 10 Year/150,000 Mile (240,000 km) Formula OAT that meets the requirements of the manufacturer Material Standard MS.90032.
- Mix a minimum solution of 50% OAT coolant that meets the requirements of the manufacturer Material Standard MS.90032 and deionized, or distilled water. Use higher concentrations (not to exceed 70%) if temperatures below  $-34^{\circ}\text{F}$  ( $-37^{\circ}\text{C}$ ) are anticipated.

### CAUTION!

Use only high purity water such as deionized, or distilled water when mixing the water/ coolant (antifreeze) solution for the engine, battery or high voltage electronics cooling systems. The use of lower quality water will reduce the amount of corrosion protection in the engine cooling system.

Please note that it is the owner's responsibility to maintain the proper level of protection against freezing according to the temperatures occurring in the area where the vehicle is operated.

#### NOTE:

- Mixing coolant types is not recommended and can result in cooling system damage. If HOAT and OAT coolant are mixed in an emergency, if the proper OAT coolant is not available, add only water to the cooling system, then have an authorized dealer drain, flush, and refill with OAT coolant (conforming to MS.90032) as soon as possible. Under no circumstances should HOAT coolant be added to the cooling system.
- Low pressure expansion bottles for power electronics and battery cooling require a special tool for removing the cap from the expansion bottle. For the battery coolant bottle, it is important to not add coolant if level is low. The vehicle should be taken to an authorized dealer for proper servicing of the battery coolant loop if this should occur.

### Cooling System Pressure Cap

The cap must be fully tightened to prevent loss of engine coolant (antifreeze), and to ensure that engine coolant will return to the radiator from the coolant expansion bottle/recovery tank (if equipped).

The cap should be inspected and cleaned if there is any accumulation of foreign material on the sealing surfaces.

#### WARNING!

- Do not open a hot engine cooling system. Never add engine coolant (antifreeze) when the engine is overheated. Do not loosen or remove the cap to cool an overheated engine. Heat causes pressure to build-up in the cooling system. To prevent scalding or injury, do not remove the pressure cap while the system is hot or under pressure.
- Do not use a pressure cap other than the one specified for your vehicle. Personal injury or engine damage may result.

### Disposal Of Used Coolant

Used ethylene glycol-based coolant (antifreeze) is a regulated substance requiring proper disposal. Check with your local authorities to determine the disposal rules for your community. To prevent ingestion by animals or children, do not store ethylene glycol-based coolant in open containers or allow it to remain in puddles on the ground, clean up any ground spills immediately. If ingested by a child or pet, seek emergency assistance immediately.

### Coolant Level

The coolant expansion bottle provides a quick visual method for determining that the coolant level is adequate. With the engine off and cold, the level of the coolant (antifreeze) in the bottle should be between the "MAX" and "MIN" lines marked on the bottle.

As long as the engine operating temperature is satisfactory, the coolant bottle need only be checked once a month.

When additional coolant is needed to maintain the proper level, it should be added to the coolant bottle. Do not overfill.

See an authorized dealer for service.

### Cooling System Notes

#### NOTE:

When the vehicle is stopped after a few miles/kilometers of operation, you may observe vapor coming from the front of the engine compartment. This is normally a result of moisture from rain, snow, or high humidity accumulating on the radiator and being vaporized when the thermostat opens, allowing hot engine coolant (antifreeze) to enter the radiator.

If an examination of the engine compartment shows no evidence of radiator or hose leaks, the vehicle may be safely driven. The vapor will soon dissipate.

- Do not overfill the coolant expansion bottle.
- Check the coolant freeze point in the radiator and in the coolant expansion bottle. If engine coolant needs to be added, the contents of the coolant expansion bottle must also be protected against freezing.
- If frequent engine coolant additions are required, the cooling system should be pressure tested for leaks.
- Maintain coolant concentration at a minimum of 50% OAT coolant (conforming to MS.90032) and deionized, or distilled water.
- Use only high purity water such as deionized, or distilled water when mixing the water/coolant solution for the engine, battery or high voltage electronics cooling systems. The use of lower quality water will reduce the amount of corrosion protection in the cooling system.

- Make sure that the coolant expansion bottle overflow hoses are not kinked or obstructed.
- Keep the front of the radiator clean. If your vehicle is equipped with air conditioning, keep the front of the condenser clean.
- Do not change the thermostat for Summer or Winter operation. If replacement is ever necessary, install **ONLY** the correct type thermostat. Other designs may result in unsatisfactory engine cooling performance, poor gas mileage, and increased emissions.
- The coolant freeze point in the battery and power electronics loop should be checked by an authorized dealer as a special tool is required to remove the cap from those expansion bottles.
- Electric/Battery coolant system must be serviced by an authorized dealer. If the coolant level is below what is specified on the reservoir, contact an authorized dealer for service. These systems require the use of high purity water such as deionized, or distilled water when mixing the water and coolant solution. The use of lower quality water will reduce the amount of corrosion protection in the cooling systems.

## BRAKE SYSTEM

In order to ensure brake system performance, all brake system components should be inspected periodically. For the proper maintenance intervals ↪ page 264.

### WARNING!

Riding the brakes can lead to brake failure and possibly a collision. Driving with your foot resting or riding on the brake pedal can result in abnormally high brake temperatures, excessive lining wear, and possible brake damage. You would not have your full braking capacity in an emergency.

## Brake Master Cylinder

The fluid in the master cylinder should be checked when performing under hood services or immediately if the Brake Warning Light is illuminated.

Be sure to clean the top of the master cylinder area before removing the cap. If necessary, add fluid to bring the fluid level up to the requirements described on the brake fluid reservoir. With disc brakes, fluid level can be expected to fall as the brake pads wear. Brake fluid level should be checked when pads are replaced. However, low fluid level may be caused by a leak and a checkup may be needed.

Use only manufacturer recommended brake fluid ↪ page 314.

### WARNING!

- Use only manufacturer recommended brake fluid ↪ page 314. Using the wrong type of brake fluid can severely damage your brake system and/or impair its performance. The proper type of brake fluid for your vehicle is also identified on the original factory installed hydraulic master cylinder reservoir.
- To avoid contamination from foreign matter or moisture, use only new brake fluid or fluid that has been in a tightly closed container. Keep the master cylinder reservoir cap secured at all times. Brake fluid in an open container absorbs moisture from the air resulting in a lower boiling point. This may cause it to boil unexpectedly during hard or prolonged braking, resulting in sudden brake failure. This could result in a collision.

*(Continued)*

### WARNING!

- Overfilling the brake fluid reservoir can result in spilling brake fluid on hot engine parts, causing the brake fluid to catch fire. Brake fluid can also damage painted and vinyl surfaces, care should be taken to avoid its contact with these surfaces.
- Do not allow petroleum-based fluid to contaminate the brake fluid. Brake seal components could be damaged, causing partial or complete brake failure. This could result in a collision.

## AUTOMATIC TRANSMISSION

### Special Additives

The manufacturer strongly recommends against using any special additives in the transmission. Automatic Transmission Fluid (ATF) is an engineered product and its performance may be impaired by supplemental additives. Therefore, do not add any fluid additives to the transmission. Avoid using transmission sealers as they may adversely affect seals.

### CAUTION!

Do not use chemical flushes in your transmission as the chemicals can damage your transmission components. Such damage is not covered by the New Vehicle Limited Warranty.

## Fluid Level Check

The fluid level is preset at the factory and does not require adjustment under normal operating conditions. Routine fluid level checks are not required; therefore the transmission has no dipstick. An authorized dealer can check your transmission fluid level using special service tools. If you notice fluid leakage or transmission malfunction, visit an authorized dealer immediately to have the transmission fluid level checked. Operating the vehicle with an improper fluid level can cause severe transmission damage.

### CAUTION!

If a transmission fluid leak occurs, visit an authorized dealer immediately. Severe transmission damage may occur. An authorized dealer has the proper tools to adjust the fluid level accurately.

## Fluid And Filter Changes

Under normal operating conditions, the fluid installed at the factory will provide satisfactory lubrication for the life of the vehicle.

Routine fluid and filter changes are not required. However, change the fluid and filter if the fluid becomes contaminated (with water, etc.), or if the transmission is disassembled for any reason.

## Selection Of Lubricant

It is important to use the proper transmission fluid to ensure optimum transmission performance and life. Use only the manufacturer specified transmission fluid → page 314. It is important to maintain the transmission fluid at the correct level using the recommended fluid.

### NOTE:

No chemical flushes should be used in any transmission; only the approved lubricant should be used.

### CAUTION!

Using a transmission fluid other than the manufacturer recommended fluid may cause deterioration in transmission shift quality and/or torque converter shudder → page 314.

## FUSES

### General Information

#### WARNING!

- When replacing a blown fuse, always use an appropriate replacement fuse with the same amp rating as the original fuse. Never replace a fuse with another fuse of higher amp rating. Never replace a blown fuse with metal wires or any other material. Do not place a fuse inside a circuit breaker cavity or vice versa. Failure to use proper fuses may result in serious personal injury, fire and/or property damage.
- Before replacing a fuse, make sure that the ignition is off and that all the other services are switched off and/or disengaged.
- If the replaced fuse blows again, contact an authorized dealer.
- If a general protection fuse for safety systems (air bag system, braking system), power unit systems (engine system, transmission system) or steering system blows, contact an authorized dealer.

The fuses protect electrical systems against excessive current.

When a device does not work, you must check the fuse element inside the blade fuse for a break/melt.

Also, please be aware that using power outlets for extended periods of time with the engine off may result in vehicle battery discharge.

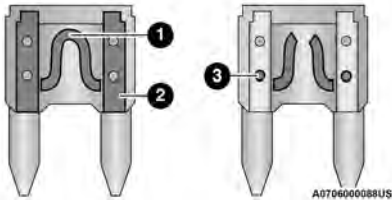

**Blade Fuses**

- 1 – Fuse Element
- 2 – Blade Fuse with a good/functional fuse element
- 3 – Blade Fuse with a bad/not functional fuse element (blown fuse)

## Underhood Fuses

The Power Distribution Center (PDC) is located in the engine compartment near the battery. This center contains cartridge fuses, mini-fuses, micro-fuses, circuit breakers and relays. A label that identifies each component is printed on the inside of the cover.

Before any procedure is done on the PDC, make sure engine is turned off.

Remove the cover by unlatching the two locks located at each side of the PDC cover, avoid using screwdrivers or any other tool to remove the cover, since they may apply excessive force and result in a broken/damaged part.

After service is done, secure the cover with its two locks.

### CAUTION!

When installing the power distribution center cover, it is important to ensure the cover is properly positioned and fully latched. Failure to do so may allow water to get into the power distribution center and possibly result in an electrical system failure.

### NOTE:

The function and amperage of the following fuses are different, depending on vehicle trim level and content.

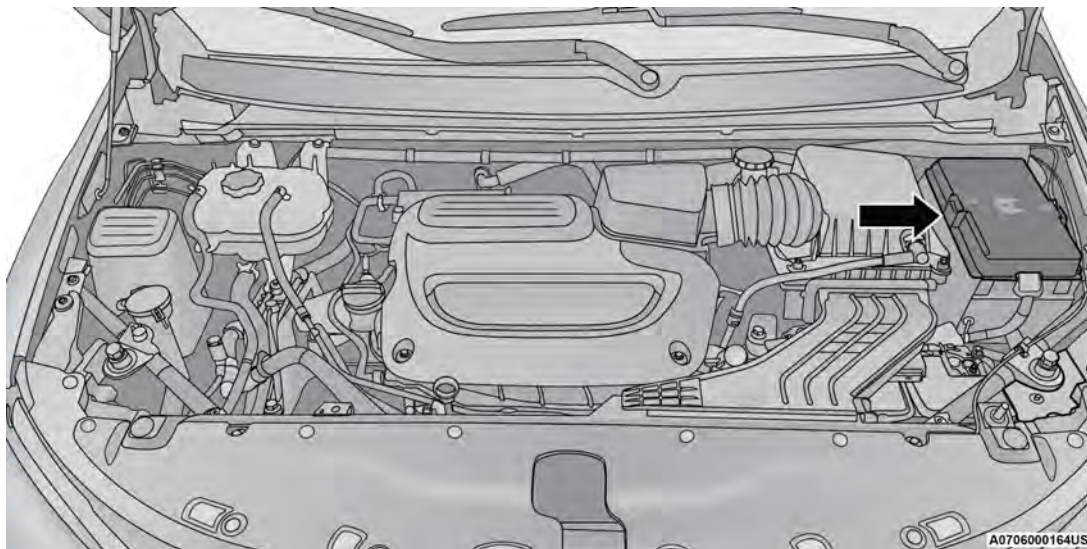

**Power Distribution Center Location**

Cavity	Cartridge Fuse	Blade Fuse	Description
	*If Equipped		
F06	-	-	Not Populated
F07	-	25 Amp Clear	Ignition Coil / Fuel Injector
F08	-	-	Not Populated

Cavity	Cartridge Fuse	Blade Fuse	Description
<b>*If Equipped</b>			
F09	-	25 Amp Clear	Amplifier / Active Noise Control *
F10	-	-	Not Populated
F11	-	-	Not Populated
F12	-	5 Amp Tan	Battery Sensor (IBS)
F13	-	10 Amp Red	ECM (S) *
F14	-	10 Amp Red	ECM
F15	40 Amp Green	-	CBC / Power Locks
F16	-	20 Amp Yellow	ECM
F17	30 Amp Pink	-	Starter
F18	40 Amp Green	-	CBC / EXT LIGHTS
F19	25 Amp Clear	-	2nd Row Folding Seats Solenoid LT *
F20	-	10 Amp Red	A/C Compressor Clutch
F21	25 Amp Clear	-	2nd Row Folding Seat Solenoid RT *
F22	-	-	Not Populated
F23	-	-	Not Populated
F24	-	20 Amp Yellow	RR Wiper
F25	-	10 Amp Red	Hands-Free Dr Mod / Active Grille Shutter / Pwr Mirror / VRM
F26	40 Amp Green	-	Front HVAC Blower Motor
F27	25 Amp Clear	-	RR Slide Door Module-RT *
F28	-	10 Amp Red	Diagnostic Port / USB+(IP) / Video USB Port / Overhead DVD Player(Aftermarket)
F29	-	-	Not Populated
F30	-	15 Amp Blue	Media HUB / Power Lumbar *
F31	-	-	Not Populated
F32	20 Amp Blue	-	ECM

Cavity	Cartridge Fuse	Blade Fuse	Description
<b>*If Equipped</b>			
F33	30 Amp Pink	-	Power Liftgate Module *
F34	25 Amp Clear	-	RR Door Module-LT *
F35	25 Amp Clear	-	Sunroof *
F36	-	-	Not Populated
F37	40 Amp Green	-	CBC / Exterior Lights
F38	60 Amp Yellow	-	Vacuum Cleaner *
F39	25 Amp Clear	-	Rear HVAC Blower Motor
F40	-	-	Not Populated
F41	-	-	Not Populated
F42	40 Amp Green	-	Folding Seat Module *
F43	-	20 Amp Yellow	Fuel Pump Motor
F44	30 Amp Pink	-	CBC / Interior Lights
F45	30 Amp Pink	-	Power Inverter *
F46	30 Amp Pink	-	Driver Door Module
F47	30 Amp Pink	-	Passenger Door Module
F48	-	-	Not Populated
F49	25 Amp Clear	-	RR Sliding Door Module-LT *
F50	25 Amp Clear	-	RR Door Module-RT *
F51	30 Amp Pink	-	Front Wiper
F52	30 Amp Pink	-	Brake Vacuum Pump
F53	-	-	Not Populated
F54	40 Amp Green	-	ESP-ECU And Valves
F55	-	15 Amp Blue	Radio Frequency HUB/ Keyless Ignition System (KIN) / ESL / DVD



Cavity	Cartridge Fuse	Blade Fuse	Description
<b>*If Equipped</b>			
F56	-	10 Amp Red	Front and Rear HVAC Control Module / Occupant Classification Module (OCM) / Electronic Steering Lock (ESL) / ESP / ESC
F57	-	-	Not Populated
F58	-	10 Amp Red	Drive Train Control Mod / Power Transfer Unit *
F59	30 Amp Pink	-	Trailer Tow Receptacle *
F60	-	20 Amp Yellow	Rear Cargo Pwr Outlet
F61	-	20 Amp Yellow	Trailer Tow Right Stop/Turn *
F62	-	20 Amp Yellow	Power Transfer Unit *
F63	-	20 Amp Yellow	Trailer Tow Left Stop/Turn *
F64	-	15 Amp Blue	RT HID Headlamp *
F65	-	-	Not Populated
F66	-	15 Amp Blue	Cluster
F67	-	10 Amp Red	Haptic Lane Feedback Module (HALF) / Parktronic System (PTS)/ Drivers Assist System Module (DASM)
F68	-	-	Not Populated
F69	-	-	Not Populated
F70	-	-	Not Populated
F71	-	20 Amp Yellow	Horn
F72	-	10 Amp Red	Heated Mirror *
F73	30 Amp Pink	-	Rear Defroster
F74	20 Amp Blue	-	Trailer Tow Backup Lights*
F75	-	5 Amp Tan	Overhead Console / RR Center Stack
F76	-	20 Amp Yellow	Uconnect / Center Display / Telematics

Cavity	Cartridge Fuse	Blade Fuse	Description
<b>*If Equipped</b>			
F77	-	10 Amp Red	RR Entertainment / Media HUB / USB(S) / Rain Sensor / Sunroof / RR View Mirror/ Overhead DVD Player / INT Monitoring Camera
F78	-	15 Amp Blue	TCM (ZF) / E-Shifter / Cluster
F79	-	10 Amp Red	ICS / HVAC / SCCM/ EPB SW
F80	-	-	Not Populated
F81	-	-	Not Populated
F82	-	-	Not Populated
F83	20 Amp Blue	-	TT Park Lights *
	30 Amp Pink	-	Headlamp Washer Pump *
F84	30 Amp Pink	-	Drive Train Control MOD *
F85	-	20 Amp Yellow	Cigar Lighter
F86	-	-	Not Populated
F87	-	-	Not Populated
F88	-	20 Amp Yellow	Front Heated Seats *
F89	-	20 Amp Yellow	Rear Heated Seats *
F90	-	-	Not Populated
F91	-	15 Amp Blue	Front Ventilated Seats/Heated Steering Wheel *
F92	-	5 Amp Tan	Security Gateway
F93	-	-	Not Populated
F94	40 Amp Green	-	ESC Motor Pump
F95A	-	10 Amp Red	USB Charge Port – ACC/RUN
F95B	-	10 Amp Red	Selectable Fuse Location – USB IP (Direct) B+
F96	-	10 Amp Red	Airbag

Cavity	Cartridge Fuse	Blade Fuse	Description
<b>*If Equipped</b>			
F97	-	10 Amp Red	Airbag
F98	-	15 Amp Blue	Left HID Headlamp *
F99	30 Amp Pink	-	Trailer Tow Elect Brake Module *
F100	-	10 Amp Red	Headlamp Level / RR Camera / Blindspot / Humidity SNSR / In Car Temp SNSR / Headlamp SW *
<b>Circuit Breakers</b>			
CB1	25 Amp		Power Seats (Driver)
CB2	25 Amp *		Power Seats (Pass)
CB3	25 Amp		FRT PWR Window W/O Door Nodes + RR PWR Window Lockout

30 Amp mini fuse is substituted for 25 Amp Circuit Breaker.

## BULB REPLACEMENT

### Replacement Bulbs, Names, And Part Numbers

In the instance a bulb needs to be replaced, this section includes bulb description and replacement part numbers.

#### NOTE:

Your vehicle is equipped with LED lamps. For replacement of LED lamps, see an authorized dealer.

#### Interior Bulbs — Halogen

Interior Bulbs	
Lamps	Bulb Number
Visor Vanity Lamps	6501966

#### NOTE:

Your vehicle is equipped with LED lamps. For replacement of LED lamps, see an authorized dealer.

## Exterior Bulbs — Halogen

Exterior Bulbs	
Lamps	Bulb Number
Front Turn Signal Lamp	WY21W / 7440NA
Front Side Marker Lamp	W3W / 2821
Rear Side Marker Lamp	W3W / 2821

## Replacing Exterior Bulbs

## FRONT TURN SIGNAL LAMP

See the following steps to replace:

1. Open the hood.
2. Twist the front turn signal lamp socket assembly counterclockwise, and then remove the front turn signal lamp assembly from the lamp housing.

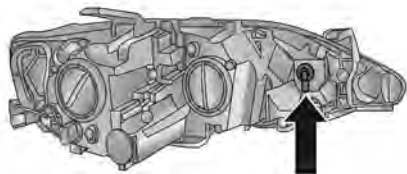

A0705000363US

Front Turn Signal Lamp Socket

3. Pull the bulb out of the socket and insert the replacement bulb.

4. Install the front turn signal lamp socket assembly into the housing, and rotate the front turn signal lamp socket clockwise to lock it in place.

## FRONT AND REAR SIDE MARKER LAMPS

See the following steps to replace:

1. Remove the three fasteners from the inner wheel liner and carefully peel back liner for access.

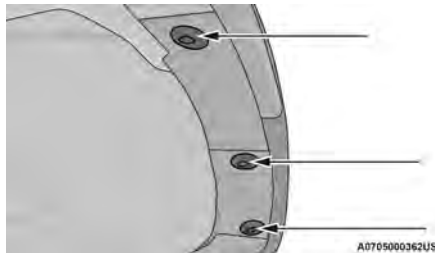

A0705000362US

Inner Wheel Liner Fasteners

2. Firmly grab the front side marker lamp socket and rotate a quarter turn counterclockwise to remove it from the lamp assembly.



A0705000368US

Front Side Marker Lamp Bulb Removal

3. Remove bulb from the front side marker lamp socket and replace with a new bulb.
4. Install front side marker lamp socket in lamp assembly and rotate a quarter turn clockwise to lock into place.
5. Position the inner wheel liner in place and install the three fasteners.

## TIRES

### TIRE SAFETY INFORMATION

Tire safety information will cover aspects of the following information: Tire Markings, Tire Identification Numbers, Tire Terminology and Definitions, Tire Pressures, and Tire Loading.

#### Tire Markings

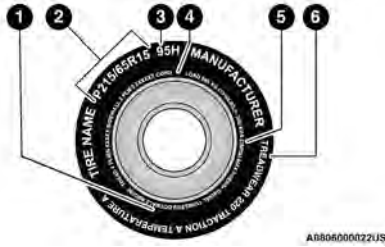

**Tire Markings**

- 1 – US DOT Safety Standards Code (TIN)
- 2 – Size Designation
- 3 – Service Description
- 4 – Maximum Load
- 5 – Maximum Pressure
- 6 – Treadwear, Traction and Temperature Grades

#### NOTE:

- P (Passenger) – Metric tire sizing is based on US design standards. P-Metric tires have the letter “P” molded into the sidewall preceding the size designation. Example: P215/65R15 95H.
- European – Metric tire sizing is based on European design standards. Tires designed to this standard have the tire size molded into the sidewall beginning with the section width. The letter “P” is absent from this tire size designation. Example: 215/65R15 96H.
- LT (Light Truck) – Metric tire sizing is based on US design standards. The size designation for LT-Metric tires is the same as for P-Metric tires except for the letters “LT” that are molded into the sidewall preceding the size designation. Example: LT235/85R16.
- Temporary spare tires are designed for temporary emergency use only. Temporary high pressure compact spare tires have the letter “T” or “S” molded into the sidewall preceding the size designation. Example: T145/80D18 103M.
- High flotation tire sizing is based on US design standards and it begins with the tire diameter molded into the sidewall. Example: 31x10.5 R15 LT.

## TIRE SIZING CHART

EXAMPLE:
<b>Example Size Designation:</b> P215/65R15XL 95H, 215/65R15 96H, LT235/85R16C, T145/80D18 103M, 31x10.5 R15 LT
<p><b>P</b> = Passenger car tire size based on US design standards, or  <b>"...blank..."</b> = Passenger car tire based on European design standards, or  <b>LT</b> = Light truck tire based on US design standards, or  <b>T or S</b> = Temporary spare tire or  <b>31</b> = Overall diameter in inches (in)  <b>215, 235, 145</b> = Section width in millimeters (mm)  <b>65, 85, 80</b> = Aspect ratio in percent (%) <ul style="list-style-type: none"> <li>● Ratio of section height to section width of tire, or <b>10.5</b> = Section width in inches (in)</li> </ul> </p>
<p><b>R</b> = Construction code <ul style="list-style-type: none"> <li>● "R" means radial construction, or</li> <li>● "D" means diagonal or bias construction</li> </ul> </p>
<b>15, 16, 18</b> = Rim diameter in inches (in)
<b>Service Description:</b>
<p><b>95</b> = Load Index <ul style="list-style-type: none"> <li>● A numerical code associated with the maximum load a tire can carry</li> </ul> </p>
<p><b>H</b> = Speed Symbol <ul style="list-style-type: none"> <li>● A symbol indicating the range of speeds at which a tire can carry a load corresponding to its load index under certain operating conditions</li> <li>● The maximum speed corresponding to the speed symbol should only be achieved under specified operating conditions (i.e., tire pressure, vehicle loading, road conditions, and posted speed limits)</li> </ul> </p>
<p><b>Load Identification:</b>  Absence of the following load identification symbols on the sidewall of the tire indicates a Standard Load (SL) tire: <ul style="list-style-type: none"> <li>● <b>XL</b> = Extra load (or reinforced) tire, or</li> <li>● <b>LL</b> = Light load tire or</li> <li>● <b>C, D, E, F, G</b> = Load range associated with the maximum load a tire can carry at a specified pressure</li> </ul> </p>
<b>Maximum Load</b> - Maximum load indicates the maximum load this tire is designed to carry
<b>Maximum Pressure</b> - Maximum pressure indicates the maximum permissible cold tire inflation pressure for this tire

## Tire Identification Number (TIN)

The TIN may be found on one or both sides of the tire; however, the date code may only be on one side. Tires with white sidewalls will have the full TIN, including the date code, located on the white sidewall side of the tire. Look for the TIN on the outboard side of black sidewall tires as mounted on the vehicle. If the TIN is not found on the outboard side, then you will find it on the inboard side of the tire.

<b>EXAMPLE:</b>
DOT MA L9 ABCD 0301
<b>DOT</b> = Department of Transportation <ul style="list-style-type: none"> <li>This symbol certifies that the tire is in compliance with the US Department of Transportation tire safety standards and is approved for highway use</li> </ul>
<b>MA</b> = Code representing the tire manufacturing location (two digits)
<b>L9</b> = Code representing the tire size (two digits)
<b>ABCD</b> = Code used by the tire manufacturer (one to four digits)
<b>03</b> = Number representing the week in which the tire was manufactured (two digits) <ul style="list-style-type: none"> <li>03 means the 3rd week</li> </ul>
<b>01</b> = Number representing the year in which the tire was manufactured (two digits) <ul style="list-style-type: none"> <li>01 means the year 2001</li> <li>Prior to July 2000, tire manufacturers were only required to have one number to represent the year in which the tire was manufactured. Example: 031 could represent the 3rd week of 1981 or 1991</li> </ul>

## Tire Terminology And Definitions

Term	Definition
<b>B-pillar</b>	The vehicle B-pillar is the structural member of the body located behind the front door.
<b>Cold Tire Inflation Pressure</b>	Cold tire inflation pressure is defined as the tire pressure after the vehicle has not been driven for at least three hours, or driven less than 1 mile (1.6 km) after sitting for a minimum of three hours. Inflation pressure is measured in units of psi (pounds per square inch) or kPa (kilopascals).
<b>Maximum Inflation Pressure</b>	The maximum inflation pressure is the maximum permissible cold tire inflation pressure for this tire. The maximum inflation pressure is molded into the sidewall.
<b>Recommended Cold Tire Inflation Pressure</b>	The manufacturer recommended cold tire inflation pressure as shown on the tire placard.
<b>Tire Placard</b>	A label permanently attached to the vehicle describing the vehicle's loading capacity, the original equipment tire sizes and the recommended cold tire inflation pressures.

## Tire Loading And Tire Pressure

### NOTE:

The proper cold tire inflation pressure is listed on the driver's side B-pillar or the rear edge of the driver's side door.

Check the inflation pressure of each tire, including the spare tire (if equipped), at least monthly and inflate to the recommended pressure for your vehicle.

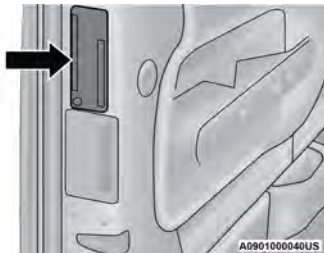

Example Tire Placard Location (Door)

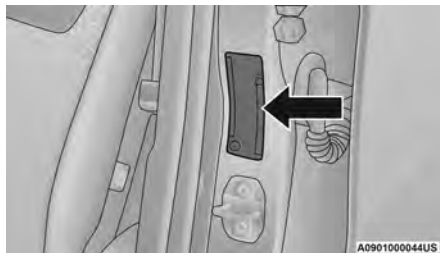

Example Tire Placard Location (B-pillar)

### Tire And Loading Information Placard

TIRE AND LOADING INFORMATION			
SEATING CAPACITY - TOTAL 5 FRONT 2 REAR 3			
THE COMBINED WEIGHT OF OCCUPANTS AND CARGO SHOULD NEVER EXCEED XXX KG OR XXX LBS.			
TIRE	FRONT	REAR	SPARE
ORIGINAL TIRE SIZE	P195/70R14	P195/70R14	T125/70D15
COLD TIRE INFLATION PRESSURE	200kPa, 29PSI	200kPa, 29PSI	420kPa, 60PSI
SEE OWNER'S MANUAL FOR ADDITIONAL INFORMATION			4N109298

Tire And Loading Information Placard

This placard tells you important information about the:

1. Number of people that can be carried in the vehicle.
2. Total weight your vehicle can carry.
3. Tire size designed for your vehicle.
4. Cold tire inflation pressures for the front, rear, and spare tires.

### Loading

The vehicle maximum load on the tire must not exceed the load carrying capacity of the tire on your vehicle. You will not exceed the tire's load carrying capacity if you adhere to the loading conditions, tire size, and cold tire inflation pressures specified on the Tire And Loading Information Placard in this manual ↪ page 160.

### NOTE:

Under a maximum loaded vehicle condition, Gross Axle Weight Ratings (GAWR) for the front and rear axles must not be exceeded.

For further information on GAWR, vehicle loading, and trailer towing, ↪ page 160.

To determine the maximum loading conditions of your vehicle, locate the statement "The combined weight of occupants and cargo should never exceed XXX kg or XXX lbs" on the Tire And Loading Information Placard. The combined weight of occupants, cargo/luggage and trailer tongue weight (if applicable) should never exceed the weight referenced here.



## Steps For Determining Correct Load Limit—

(1) Locate the statement “The combined weight of occupants and cargo should never exceed XXX kg or XXX lbs.” on your vehicle’s placard.

(2) Determine the combined weight of the driver and passengers that will be riding in your vehicle.

(3) Subtract the combined weight of the driver and passengers from XXX kg or XXX lbs.

(4) The resulting figure equals the available amount of cargo and luggage load capacity. For example, if “XXX” amount equals 1400 lbs. and there will be five 150 lb passengers in your vehicle, the amount of available cargo and luggage load capacity is 650 lbs. (1400-750 (5x150) = 650 lbs.)

(5) Determine the combined weight of luggage and cargo being loaded on the vehicle. That weight may not safely exceed the available cargo and luggage load capacity calculated in Step 4.

(6) If your vehicle will be towing a trailer, load from your trailer will be transferred to your vehicle. Consult this manual to determine how this reduces the available cargo and luggage load capacity of your vehicle.

### Metric Example For Load Limit

For example, if “XXX” amount equals 635 kg and there will be five 68 kg passengers in your vehicle, the amount of available cargo and luggage load capacity is 295 kg (635-340 (5x68) = 295 kg) as shown in step 4.

### NOTE:

- If your vehicle will be towing a trailer, load from your trailer will be transferred to your vehicle. The following table shows examples on how to calculate total load, cargo/luggage, and towing capacities of your vehicle with varying seating configurations and number and size of occupants. This table is for illustration purposes only and may not be accurate for the seating and load carry capacity of your vehicle.
- For the following example, the combined weight of occupants and cargo should never exceed 865 lbs (392 kg).

Occupants			Combined weight of occupants and cargo from Tire Placard	MINUS	Combined Occupant's weight	=	AVAILABLE Cargo/Luggage and Trailer Tongue Weight
TOTAL	FRONT	REAR					
<b>EXAMPLE 1</b>			↓ 865 lbs	minus	Occupant 1: 200 lbs Occupant 2: 130 lbs Occupant 3: 160 lbs Occupant 4: 100 lbs Occupant 5: 80 lbs TOTAL WEIGHT: 670 lbs	=	↓ 195 lbs
5	2	3					
<b>EXAMPLE 2</b>			↓ 865 lbs	minus	Occupant 1: 210 lbs Occupant 2: 180 lbs Occupant 3: 150 lbs TOTAL WEIGHT: 540 lbs	=	325 lbs
3	2	1					
<b>EXAMPLE 3</b>			↓ 865 lbs	minus	Occupant 1: 200 lbs Occupant 2: 200 lbs TOTAL WEIGHT: 400 lbs	=	465 lbs
2	2	0					

811a4d11

**WARNING!**

Overloading of your tires is dangerous. Overloading can cause tire failure, affect vehicle handling, and increase your stopping distance. Use tires of the recommended load capacity for your vehicle. Never overload them.

## TIRES — GENERAL INFORMATION

### Tire Pressure

Proper tire inflation pressure is essential to the safe and satisfactory operation of your vehicle. Four primary areas are affected by improper tire pressure:

- Safety
- Fuel Economy
- Tread Wear
- Ride Comfort and Vehicle Stability

### Safety

#### WARNING!

- Improperly inflated tires are dangerous and can cause collisions.
- Underinflation increases tire flexing and can result in overheating and tire failure.
- Overinflation reduces a tire's ability to cushion shock. Objects on the road and chuckholes can cause damage that result in tire failure.
- Overinflated or underinflated tires can affect vehicle handling and can fail suddenly, resulting in loss of vehicle control.
- Unequal tire pressures can cause steering problems. You could lose control of your vehicle.
- Unequal tire pressures from one side of the vehicle to the other can cause the vehicle to drift to the right or left.
- Always drive with each tire inflated to the recommended cold tire inflation pressure.

Both underinflation and overinflation affect the stability of the vehicle and can produce a feeling of sluggish response or over responsiveness in the steering.

#### NOTE:

- Unequal tire pressures from side to side may cause erratic and unpredictable steering response.
- Unequal tire pressure from side to side may cause the vehicle to drift left or right.

#### Fuel Economy

Underinflated tires will increase tire rolling resistance resulting in higher fuel consumption.

#### Tread Wear

Improper cold tire inflation pressures can cause abnormal wear patterns and reduced tread life, resulting in the need for earlier tire replacement.

#### Ride Comfort And Vehicle Stability

Proper tire inflation contributes to a comfortable ride. Overinflation produces a jarring and uncomfortable ride.

### Tire Inflation Pressures

The proper cold tire inflation pressure is listed on the driver's side B-pillar or rear edge of the driver's side door.

At least once a month:

- Check and adjust tire pressure with a good quality pocket-type pressure gauge. Do not make a visual judgment when determining proper inflation. Tires may look properly inflated even when they are underinflated.
- Inspect tires for signs of tire wear or visible damage.

#### CAUTION!

After inspecting or adjusting the tire pressure, always reinstall the valve stem cap. This will prevent moisture and dirt from entering the valve stem, which could damage the valve stem.

Inflation pressures specified on the placard are always "cold tire inflation pressure". Cold tire inflation pressure is defined as the tire pressure after the vehicle has not been driven for at least three hours, or driven less than 1 mile (1.6 km) after sitting for a minimum of three hours. The cold tire inflation pressure must not exceed the maximum inflation pressure molded into the tire sidewall.

Check tire pressures more often if subject to a wide range of outdoor temperatures, as tire pressures vary with temperature changes.

Tire pressures change by approximately 1 psi (7 kPa) per 12°F (7°C) of air temperature change. Keep this in mind when checking tire pressure inside a garage, especially in the Winter.

Example: If garage temperature = 68°F (20°C) and the outside temperature = 32°F (0°C) then the cold tire inflation pressure should be increased by 3 psi (21 kPa), which equals 1 psi (7 kPa) for every 12°F (7°C) for this outside temperature condition.

Tire pressure may increase from 2 to 6 psi (13 to 40 kPa) during operation. DO NOT reduce this normal pressure build-up or your tire pressure will be too low.

## Tire Pressures For High Speed Operation

The manufacturer advocates driving at safe speeds and within posted speed limits. Where speed limits or conditions are such that the vehicle can be driven at high speeds, maintaining correct tire inflation pressure is very important. Increased tire pressure and reduced vehicle loading may be required for high-speed vehicle operation. Refer to an authorized tire dealer or original equipment vehicle dealer for recommended safe operating speeds, loading and cold tire inflation pressures.

### WARNING!

High speed driving with your vehicle under maximum load is dangerous. The added strain on your tires could cause them to fail. You could have a serious collision. Do not drive a vehicle loaded to the maximum capacity at continuous speeds above 75 mph (120 km/h).

## Radial Ply Tires

### WARNING!

Combining radial ply tires with other types of tires on your vehicle will cause your vehicle to handle poorly. The instability could cause a collision. Always use radial ply tires in sets of four. Never combine them with other types of tires.

## Tire Repair

If your tire becomes damaged, it may be repaired if it meets the following criteria:

- The tire has not been driven on when flat.
- The damage is only on the tread section of your tire (sidewall damage is not repairable).
- The puncture is no greater than  $\frac{3}{4}$  of an inch (6 mm).

Consult an authorized tire dealer for tire repairs and additional information.

Damaged Run Flat tires, or Run Flat tires that have experienced a loss of pressure should be replaced immediately with another Run Flat tire of identical size and service description (Load Index and Speed Symbol). Replace the tire pressure sensor as well as it is not designed to be reused.

## Run Flat Tires — If Equipped

Run Flat tires allow you the capability to drive 50 miles (80 km) at 50 mph (80 km/h) after a rapid loss of inflation pressure. This rapid loss of inflation is referred to as the Run Flat mode. A Run Flat mode occurs when the tire inflation pressure is of/or below 14 psi (96 kPa). Once a Run Flat tire reaches the Run Flat mode it has limited driving capabilities and needs to be replaced immediately. A Run Flat tire is not repairable. When a Run Flat tire is changed after being driven in the Run Flat mode 14 psi (96 kPa) condition, please replace the TPMS sensor as it is not designed to be reused.

### NOTE:

TPMS sensor must be replaced after driving the vehicle on a flat tire condition.

It is not recommended driving a vehicle loaded at full capacity or to tow a trailer while a tire is in the Run Flat mode → page 205.

## Tire Spinning

When stuck in mud, sand, snow, or ice conditions, do not spin your vehicle's wheels above 30 mph (48 km/h) or for longer than 30 seconds continuously without stopping.

### WARNING!

Fast spinning tires can be dangerous. Forces generated by excessive wheel speeds may cause tire damage or failure. A tire could explode and injure someone. Do not spin your vehicle's wheels faster than 30 mph (48 km/h) for more than 30 seconds continuously when you are stuck, and do not let anyone near a spinning wheel, no matter what the speed.

## Tread Wear Indicators

Tread wear indicators are in the original equipment tires to help you in determining when your tires should be replaced.

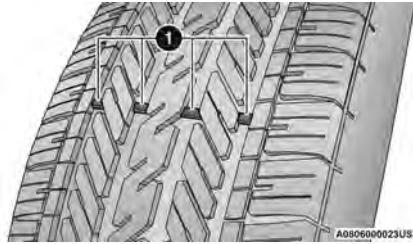

Tire Tread

### 1 – Tread Wear Indicators

These indicators are molded into the bottom of the tread grooves. They will appear as bands when the tread depth becomes 1/16 of an inch (1.6 mm). When the tread is worn to the tread wear indicators, the tire should be replaced ↪ page 299.

### Life Of Tire

The service life of a tire is dependent upon varying factors including, but not limited to:

- Driving style.
- Tire pressure - Improper cold tire inflation pressures can cause uneven wear patterns to develop across the tire tread. These abnormal wear patterns will reduce tread life, resulting in the need for earlier tire replacement.
- Distance driven.
- Performance tires, tires with a speed rating of V or higher, and Summer tires typically have a reduced tread life. Rotation of these tires per the vehicle scheduled maintenance is highly recommended.

### WARNING!

Tires and the spare tire should be replaced after six years, regardless of the remaining tread. Failure to follow this warning can result in sudden tire failure. You could lose control and have a collision resulting in serious injury or death.

### NOTE:

Wheel valve stem must be replaced as well when installing new tires due to wear and tear in existing tires.

Keep dismounted tires in a cool, dry place with as little exposure to light as possible. Protect tires from contact with oil, grease, and gasoline.

### Replacement Tires

The tires on your new vehicle provide a balance of many characteristics. They should be inspected regularly for wear and correct cold tire inflation pressures. The manufacturer strongly recommends using tires equivalent to the originals in size, quality and performance when replacement is needed ↪ page 298. The Load Index and Speed Symbol for your tire will be found on the original equipment tire sidewall.

See the Tire Sizing Chart example found in the Tire Safety Information section of this manual for more information relating to the Load Index and Speed Symbol of a tire ↪ page 292.

It is recommended to replace the two front tires or two rear tires as a pair. Replacing just one tire can seriously affect your vehicle's handling. If you ever replace a wheel, make sure that the wheel's specifications match those of the original wheels.

It is recommended you contact an authorized tire dealer or original equipment dealer with any questions you may have on tire specifications or capability. Failure to use equivalent replacement tires may adversely affect the safety, handling, and ride of your vehicle.

### WARNING!

- Do not use a tire, wheel size, load rating, or speed rating other than that specified for your vehicle. Some combinations of unapproved tires and wheels may change suspension dimensions and performance characteristics, resulting in changes to steering, handling, and braking of your vehicle. This can cause unpredictable handling and stress to steering and suspension components. You could lose control and have a collision resulting in serious injury or death. Use only the tire and wheel sizes with load ratings approved for your vehicle.
- Never use a tire with a smaller load index or capacity, other than what was originally equipped on your vehicle. Using a tire with a smaller load index could result in tire overloading and failure. You could lose control and have a collision.
- Failure to equip your vehicle with tires having adequate speed capability can result in sudden tire failure and loss of vehicle control.

### CAUTION!

Replacing original tires with tires of a different size may result in false speedometer and odometer readings.

## TIRE TYPES

### All Season Tires — If Equipped

All season tires provide traction for all seasons (Spring, Summer, Autumn, and Winter). Traction levels may vary between different all season tires. All season tires can be identified by the M+S, M&S, M/S or MS designation on the tire sidewall. Use all season tires only in sets of four; failure to do so may adversely affect the safety and handling of your vehicle.

### Summer Or Three Season Tires — If Equipped

Summer tires provide traction in both wet and dry conditions, and are not intended to be driven in snow or on ice. If your vehicle is equipped with Summer tires, be aware these tires are not designed for Winter or cold driving conditions. Install Winter tires on your vehicle when ambient temperatures are less than 40°F (5°C) or if roads are covered with ice or snow. For more information, contact an authorized dealer.

Summer tires do not contain the all season designation or mountain/snowflake symbol on the tire sidewall. Use Summer tires only in sets of four; failure to do so may adversely affect the safety and handling of your vehicle.

#### WARNING!

Do not use Summer tires in snow/ice conditions. You could lose vehicle control, resulting in severe injury or death. Driving too fast for conditions also creates the possibility of loss of vehicle control.

### Snow Tires



Some areas of the country require the use of snow tires during the Winter. Snow tires can be identified by a mountain/snowflake symbol on the tire sidewall. If you need snow tires, select tires equivalent in size and type to the original equipment tires. Use snow tires only in sets of four; failure to do so may adversely affect the safety and handling of your vehicle.

Snow tires generally have lower speed ratings than what was originally equipped with your vehicle and should not be operated at sustained speeds over 75 mph (120 km/h). For speeds above 75 mph (120 km/h) refer to original equipment or an authorized tire dealer for recommended safe operating speeds, loading and cold tire inflation pressures.

While studded tires improve performance on ice, skid and traction capability on wet or dry surfaces may be poorer than that of non-studded tires. Some states prohibit studded tires; therefore, local laws should be checked before using these tire types.

## SPARE TIRES — IF EQUIPPED

#### NOTE:

For vehicles equipped with Tire Service Kit instead of a spare tire ↪ page 250.

#### CAUTION!

Because of the reduced ground clearance, do not take your vehicle through an automatic car wash with a compact or limited use temporary spare installed. Damage to the vehicle may result.

For restrictions when towing with a spare tire designated for temporary emergency use ↪ page 165.

### Spare Tire Matching Original Equipped Tire And Wheel — If Equipped

Your vehicle may be equipped with a spare tire and wheel equivalent in look and function to the original equipment tire and wheel found on the front or rear axle of your vehicle. This spare tire may be used in the tire rotation for your vehicle. If your vehicle has this option, refer to an authorized tire dealer for the recommended tire rotation pattern.

### Compact Spare Tire — If Equipped

The compact spare is for temporary emergency use only. You can identify if your vehicle is equipped with a compact spare by looking at the spare tire description on the Tire And Loading Information Placard located on the driver's side door opening or on the sidewall of the tire. Compact spare tire descriptions begin with the letter "T" or "S" preceding the size designation. Example: T145/80D18 103M.

T, S = Temporary Spare Tire

Since this tire has limited tread life, the original equipment tire should be repaired (or replaced) and reinstalled on your vehicle at the first opportunity.

Do not install a wheel cover or attempt to mount a conventional tire on the compact spare wheel, since the wheel is designed specifically for the compact spare tire. Do not install more than one compact spare tire and wheel on the vehicle at any given time.

**WARNING!**

Compact and collapsible spares are for temporary emergency use only. With these spares, do not drive more than 50 mph (80 km/h). Temporary use spares have limited tread life. When the tread is worn to the tread wear indicators, the temporary use spare tire needs to be replaced. Be sure to follow the warnings, which apply to your spare. Failure to do so could result in spare tire failure and loss of vehicle control.

**WARNING!**

Compact and collapsible spares are for temporary emergency use only. With these spares, do not drive more than 50 mph (80 km/h). Temporary use spares have limited tread life. When the tread is worn to the tread wear indicators, the temporary use spare tire needs to be replaced. Be sure to follow the warnings, which apply to your spare. Failure to do so could result in spare tire failure and loss of vehicle control.

**WARNING!**

Limited use spares are for emergency use only. Installation of this limited use spare tire affects vehicle handling. With this tire, do not drive more than the speed listed on the limited use spare wheel. Keep inflated to the cold tire inflation pressures listed on your Tire And Loading Information Placard located on the driver's side B-pillar or the rear edge of the driver's side door. Replace (or repair) the original equipment tire at the first opportunity and reinstall it on your vehicle. Failure to do so could result in loss of vehicle control.

**Collapsible Spare Tire — If Equipped**

The collapsible spare is for temporary emergency use only. You can identify if your vehicle is equipped with a collapsible spare by looking at the spare tire description on the Tire And Loading Information Placard located on the driver's side door opening or on the sidewall of the tire.

Collapsible spare tire description example:  
165/80-17 101P.

Since this tire has limited tread life, the original equipment tire should be repaired (or replaced) and reinstalled on your vehicle at the first opportunity.

Inflate collapsible tire only after the wheel is properly installed to the vehicle. Inflate the collapsible tire using the electric air pump before lowering the vehicle.

Do not install a wheel cover or attempt to mount a conventional tire on the collapsible spare wheel, since the wheel is designed specifically for the collapsible spare tire.

**Full Size Spare — If Equipped**

The full size spare is for temporary emergency use only. This tire may look like the originally equipped tire on the front or rear axle of your vehicle, but it is not. This spare tire may have limited tread life. When the tread is worn to the tread wear indicators, the temporary use full size spare tire needs to be replaced. Since it is not the same as your original equipment tire, replace (or repair) the original equipment tire and reinstall on the vehicle at the first opportunity.

**Limited Use Spare — If Equipped**

The limited use spare tire is for temporary emergency use only. This tire is identified by a label located on the limited use spare wheel. This label contains the driving limitations for this spare. This tire may look like the original equipped tire on the front or rear axle of your vehicle, but it is not. Installation of this limited use spare tire affects vehicle handling. Since it is not the same as your original equipment tire, replace (or repair) the original equipment tire and reinstall on the vehicle at the first opportunity.

**WHEEL AND WHEEL TRIM CARE**

All wheels and wheel trim, especially aluminum and chrome plated wheels, should be cleaned regularly using mild (neutral Ph) soap and water to maintain their luster and to prevent corrosion. Wash wheels with the same soap solution recommended for the body of the vehicle and remember to always wash when the surfaces are not hot to the touch.

Your wheels are susceptible to deterioration caused by salt, sodium chloride, magnesium chloride, calcium chloride, etc., and other road chemicals used to melt ice or control dust on dirt roads. Use a soft cloth or sponge and mild soap to wipe away promptly. Do not use harsh chemicals or a stiff brush. They can damage the wheel's protective coating that helps keep them from corroding and tarnishing.

**CAUTION!**

Avoid products or automatic car washes that use acidic solutions or strong alkaline additives or harsh brushes. Many aftermarket wheel cleaners and automatic car washes may damage the wheel's protective finish. Such damage is not covered by the New Vehicle Limited Warranty. Only car wash soap, Mopar® Wheel Cleaner or equivalent is recommended.

When cleaning extremely dirty wheels including excessive brake dust, care must be taken in the selection of tire and wheel cleaning chemicals and equipment to prevent damage to the wheels. Mopar® Wheel Treatment or Mopar® Chrome Cleaner or their equivalent is recommended or select a non-abrasive, non-acidic cleaner for aluminum or chrome wheels.

**CAUTION!**

Do not use scouring pads, steel wool, a bristle brush, metal polishes or oven cleaner. These products may damage the wheel's protective finish. Such damage is not covered by the New Vehicle Limited Warranty. Only car wash soap, Mopar® Wheel Cleaner or equivalent is recommended.

**NOTE:**

If you intend parking or storing your vehicle for an extended period after cleaning the wheels with wheel cleaner, drive your vehicle and apply the brakes to remove the water droplets from the brake components. This activity will remove the red rust on the brake rotors and prevent vehicle vibration when braking.

**Dark Vapor Chrome, Black Satin Chrome, or Low Gloss Clear Coat Wheels**

**CAUTION!**

If your vehicle is equipped with these specialty wheels, DO NOT USE wheel cleaners, abrasives, or polishing compounds. They will permanently damage this finish and such damage is not covered by the New Vehicle Limited Warranty. HAND WASH ONLY USING MILD SOAP AND WATER WITH A SOFT CLOTH. Used on a regular basis; this is all that is required to maintain this finish.

**SNOW TRACTION DEVICES**

Use of traction devices require sufficient tire-to-body clearance. Due to limited clearance, the following snow traction devices are recommended. Follow these recommendations to guard against damage:

- Snow traction device must be of proper size for the tire, as recommended by the snow traction device manufacturer.
- No other tire sizes are recommended for use with the snow traction device.
- Please follow the table for the recommended tire size, axle and snow traction device:

FWD Trim Level	Axle	Tire/Wheel Size	Snow Traction Device (Maximum Projection Beyond Tire Profile Or Equivalent)
Touring Touring L	Front	235/65R17 235/60R18	9 mm Cable/Chain
Limited Pinnacle		235/60R18	



FWD Hybrid Trim Level	Axle	Tire/Wheel Size	Snow Traction Device (Maximum Projection Beyond Tire Profile Or Equivalent)
Touring L	Front	235/65R17	9 mm Cable/Chain
Limited		235/60R18	
Pinnacle		235/60R18	

AWD Trim Level	Axle	Tire/Wheel Size	Snow Traction Device (Maximum Projection Beyond Tire Profile Or Equivalent)
Touring L	Front	235/60R18	9 mm Cable/Chain
Limited			

**WARNING!**

Using tires of different size and type (M+S, Snow) between front and rear axles can cause unpredictable handling. You could lose control and have a collision.

**CAUTION!**

To avoid damage to your vehicle or tires, observe the following precautions:

- Because of restricted traction device clearance between tires and other suspension components, it is important that only traction devices in good condition are used. Broken devices can cause serious damage. Stop the vehicle immediately if noise occurs that could indicate device breakage. Remove the damaged parts of the device before further use.
- Install device as tightly as possible and then retighten after driving about ½ mile (0.8 km). Autosock traction devices do not require retightening.
- Do not exceed 30 mph (48 km/h).
- Drive cautiously and avoid severe turns and large bumps, especially with a loaded vehicle.
- Do not drive for a prolonged period on dry pavement.
- Observe the traction device manufacturer's instructions on the method of installation, operating speed, and conditions for use. Always use the suggested operating speed of the device manufacturer's if it is less than 30 mph (48 km/h).
- Do not use traction devices on a compact spare tire.

## TIRE ROTATION RECOMMENDATIONS

The tires on the front and rear of your vehicle operate at different loads and perform different steering, driving, and braking functions. For these reasons, they wear at unequal rates.

These effects can be reduced by timely rotation of tires. The benefits of rotation are especially worthwhile with aggressive tread designs such as those on all season type tires. Rotation will increase tread life, help to maintain mud, snow and wet traction levels, and contribute to a smooth, quiet ride.

The reasons for any rapid or unusual wear should be corrected prior to rotation being performed  
 ⇨ page 264.

The suggested rotation method is the “forward cross” shown in the following diagram. This rotation pattern does not apply to some directional tires that must not be reversed.

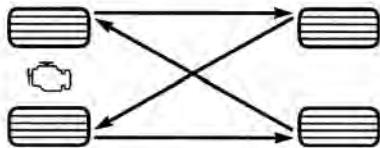

085707139

**Tire Rotation (Forward Cross)**

## DEPARTMENT OF TRANSPORTATION UNIFORM TIRE QUALITY GRADES

The following tire grading categories were established by the National Highway Traffic Safety Administration. The specific grade rating assigned by the tire's manufacturer in each category is shown on the sidewall of the tires on your vehicle.

All passenger vehicle tires must conform to Federal safety requirements in addition to these grades.

### TREADWEAR

The Treadwear grade is a comparative rating, based on the wear rate of the tire when tested under controlled conditions on a specified government test course. For example, a tire graded 150 would wear one and one-half times as well on the government course as a tire graded 100. The relative performance of tires depends upon the actual conditions of their use, however, and may depart signifi-

cantly from the norm due to variations in driving habits, service practices, and differences in road characteristics and climate.

### TRACTION GRADES

The Traction grades, from highest to lowest, are AA, A, B, and C. These grades represent the tire's ability to stop on wet pavement, as measured under controlled conditions on specified government test surfaces of asphalt and concrete. A tire marked C may have poor traction performance.

#### WARNING!

The traction grade assigned to this tire is based on straight-ahead braking traction tests, and does not include acceleration, cornering, hydroplaning, or peak traction characteristics.

## TEMPERATURE GRADES

The Temperature grades are A (the highest), B, and C, representing the tire's resistance to the generation of heat and its ability to dissipate heat, when tested under controlled conditions on a specified indoor laboratory test wheel.

Sustained high temperature can cause the material of the tire to degenerate and reduce tire life, and excessive temperature can lead to sudden tire failure. The grade C corresponds to a level of performance, which all passenger vehicle tires must meet under the Federal Motor Vehicle Safety Standard No. 109. Grades B and A represent higher levels of performance on the laboratory test wheel, than the minimum required by law.

### WARNING!

The temperature grade for this tire is established for a tire that is properly inflated and not overloaded. Excessive speed, underinflation, or excessive loading, either separately or in combination, can cause heat buildup and possible tire failure.

## STORING THE VEHICLE

If you are storing your vehicle for more than three weeks, we recommend that you take the following steps to minimize the drain on your vehicle's battery:

- Disconnect the negative cable from battery.
- Any time you store your vehicle or keep it out of service (i.e., vacation) for two weeks or more, run the air conditioning system at idle for about five minutes in the fresh air and high blower setting. This will ensure adequate system lubrication to minimize the possibility of compressor damage when the system is started again.

## STORING THE VEHICLE — HYBRID MODELS (IF EQUIPPED)

If the vehicle should remain stationary for more than a month, observe the following precautions:

- Park your vehicle in a covered, dry and possibly airy location with the windows open slightly.
- Check that the Electric Park Brake is not engaged.
- Disconnect the negative (-) terminal from the battery post and be sure that the battery is fully charged. During storage check battery charge quarterly.

### NOTE:

Disconnecting the 12 Volt battery will prevent the High Voltage (HV) Battery from accepting a charge from the Electric Vehicle Supply Equipment (EVSE). Also, the vehicle will not condition the HV Battery (if needed and connected to a powered EVSE). If the HV Battery is not able to condition itself and it becomes cold enough (or hot enough), the vehicle will not start until the HV Battery's cell temperatures are between -22° F (-30° C) and 122° F (50° C).

- If you do not disconnect the battery from the electrical system, check the battery charge every 30 days.
- Whenever you leave the vehicle stationary for two weeks or more, idle the vehicle for approximately five minutes, with the air conditioning system on and high fan speed. This will ensure proper lubrication of the system, thus minimizing the possibility of damage to the compressor when the vehicle is put back into operation.
- Plug in the vehicle when not using it whenever possible.

**NOTE:**

The hybrid has a feature of periodic wake-up that occurs every 21 days. This feature charges the 12 Volt battery from the high voltage battery. This will happen as long as the high voltage battery remains above the minimum state of charge → page 122.

**CAUTION!**

Before removal of the positive and negative terminals to the battery, wait at least a minute with ignition switch in the OFF position and close the driver's door. When reconnecting the positive and negative terminals to the battery be sure the ignition switch is in the OFF position and the driver's door is closed.

**BODYWORK****PROTECTION FROM ATMOSPHERIC AGENTS**

Vehicle body care requirements vary according to geographic locations and usage. Chemicals that make roads passable in snow and ice and those that are sprayed on trees and road surfaces during other seasons are highly corrosive to the metal in your vehicle. Outside parking, which exposes your vehicle to airborne contaminants, road surfaces on which the vehicle is operated, extreme hot or cold weather and other extreme conditions will have an adverse effect on paint, metal trim, and underbody protection.

The following maintenance recommendations will enable you to obtain maximum benefit from the corrosion resistance built into your vehicle.

**What Causes Corrosion?**

Corrosion is the result of deterioration or removal of paint and protective coatings from your vehicle.

The most common causes are:

- Road salt, dirt and moisture accumulation.
- Stone and gravel impact.
- Insects, tree sap and tar.
- Salt in the air near seacoast localities.
- Atmospheric fallout/industrial pollutants.

**BODY AND UNDERBODY MAINTENANCE****Cleaning Headlights**

Your vehicle is equipped with plastic headlights and fog lights that are lighter and less susceptible to stone breakage than glass headlights.

Plastic is not as scratch resistant as glass and therefore different lens cleaning procedures must be followed.

To minimize the possibility of scratching the lenses and reducing light output, avoid wiping with a dry cloth. To remove road dirt, wash with a mild soap solution followed by rinsing.

Do not use abrasive cleaning components, solvents, steel wool or other aggressive material to clean the lenses.

**PRESERVING THE BODYWORK****Washing**

- Wash your vehicle regularly. Always wash your vehicle in the shade using Mopar® Car Wash, or a mild car wash soap, and rinse the panels completely with water.
- If insects, tar, or other similar deposits have accumulated on your vehicle, use Mopar® Super Kleen Bug and Tar Remover to get rid of any deposits.
- Use a high quality cleaner wax, such as Mopar® Cleaner Wax to remove road film, stains and to protect your paint finish. Use precautions to not scratch the paint.
- Avoid using abrasive compounds and power buffing that may diminish the gloss or thin out the paint finish.

**CAUTION!**

- Do not use abrasive or strong cleaning materials such as steel wool or scouring powder that will scratch metal and painted surfaces.
- Use of power washers exceeding 1,200 psi (8,274 kPa) can result in damage or removal of paint and decals.

## Special Care

- If you drive on salted or dusty roads or if you drive near the ocean, hose off the undercarriage at least once a month.
- It is important that the drain holes in the lower edges of the doors, rocker panels, and trunk be kept clear and open.
- If you detect any stone chips or scratches in the paint, touch them up immediately. The cost of such repairs is considered the responsibility of the owner.
- If your vehicle is damaged due to a collision or similar cause that destroys the paint and protective coating, have your vehicle repaired as soon as possible. The cost of such repairs is considered the responsibility of the owner.
- If you carry special cargo such as chemicals, fertilizers, de-icer salt, etc., be sure that such materials are well packaged and sealed.
- If a lot of driving is done on gravel roads, consider mud or stone shields behind each wheel.
- Use Mopar® Touch Up Paint on scratches as soon as possible. An authorized dealer has touch up paint to match the color of your vehicle.

## INTERIORS

### SEATS AND FABRIC PARTS

Use Mopar® Total Clean to clean fabric upholstery and carpeting.

#### WARNING!

Do not use volatile solvents for cleaning purposes. Many are potentially flammable, and if used in closed areas they may cause respiratory harm.

### Seat Belt Maintenance

Do not bleach, dye or clean the belts with chemical solvents or abrasive cleaners. This will weaken the fabric. If the belts need cleaning, use a mild soap solution or lukewarm water. Do not remove the belts from the vehicle to wash them. Dry with a soft cloth.

Sun damage can also weaken the fabric. Replace the belts if they appear frayed or worn or if the buckles do not work properly.

#### WARNING!

A frayed or torn seat belt could rip apart in a collision and leave you with no protection. Inspect the seat belt system periodically, checking for cuts, frays, or loose parts. Damaged parts must be replaced immediately. Do not disassemble or modify the seat belt system. If your vehicle is involved in a collision, or if you have questions regarding seat belt or retractor conditions, take your vehicle to an authorized FCA dealer or authorized FCA Certified Collision Care Program facility for inspection.

### PLASTIC AND COATED PARTS

Use Mopar® Total Clean to clean vinyl upholstery.

#### CAUTION!

- Direct contact of air fresheners, insect repellents, suntan lotions, or hand sanitizers to the plastic, painted, or decorated surfaces of the interior may cause permanent damage. Wipe away immediately.
- Damage caused by these type of products may not be covered by your New Vehicle Limited Warranty.

## Cleaning Plastic Instrument Cluster Lenses

The lenses in front of the instruments in this vehicle are molded in clear plastic. When cleaning the lenses, care must be taken to avoid scratching the plastic.

Clean with a wet soft cloth. A mild soap solution may be used, but do not use high alcohol content or abrasive cleaners. If soap is used, wipe clean with a clean damp cloth. Dry with a soft cloth.

## LEATHER SURFACES

Mopar® Total Clean is specifically recommended for leather upholstery.

Your leather upholstery can be best preserved by regular cleaning with a damp soft cloth. Small particles of dirt can act as an abrasive and damage the leather upholstery and should be removed promptly with a damp cloth. Stubborn soils can be removed easily with a soft cloth and Mopar® Total Clean. Care should be taken to avoid soaking your leather upholstery with any liquid. Please do not use polishes, oils, cleaning fluids, solvents, detergents, or ammonia-based cleaners to clean your leather upholstery.

### NOTE:

If equipped with light colored leather, it tends to show any foreign material, dirt, and fabric dye transfer more so than darker colors. The leather is designed for easy cleaning, and the manufacturer recommends Mopar® total care leather cleaner applied on a cloth to clean the leather seats as needed.

### CAUTION!

Do not use alcohol and alcohol-based and/or ketone-based cleaning products to clean leather seats, as damage to the seat may result.

## GLASS SURFACES

All glass surfaces should be cleaned on a regular basis with Mopar® Glass Cleaner, or any commercial household-type glass cleaner. Never use an abrasive type cleaner. Use caution when cleaning the inside rear window equipped with electric defrosters or windows equipped with radio antennas. Do not use scrapers or other sharp instruments that may scratch the elements.

When cleaning the rearview mirror, spray cleaner on the towel or cloth that you are using. Do not spray cleaner directly on the mirror.

# TECHNICAL SPECIFICATIONS

## VEHICLE IDENTIFICATION NUMBER (VIN)

The VIN is on the left front corner of the instrument panel and is visible from outside of the vehicle through the windshield.

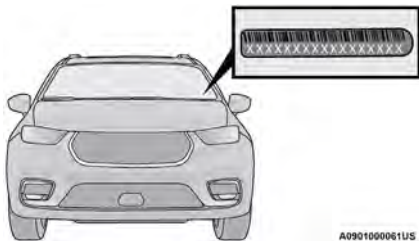

Vehicle Identification Number

A0901090061US

### NOTE:

It is illegal to remove or alter the VIN.

## BRAKE SYSTEM

Your vehicle is equipped with dual hydraulic brake systems. If either of the two hydraulic systems lose normal capability, the remaining system will still function. However, there will be some loss of overall braking effectiveness. You may notice increased pedal travel during application, greater pedal force required to slow or stop, and potential activation of the Brake Warning Light.

In the event power assist is lost for any reason (i.e., repeated brake applications with the engine off) the brakes will still function. However, the effort required to brake the vehicle will be much greater.

## WHEEL AND TIRE TORQUE SPECIFICATIONS

Proper lug nut/bolt torque is very important to ensure that the wheel is properly mounted to the vehicle. Any time a wheel has been removed and reinstalled on the vehicle, the lug nuts/bolts should be torqued using a properly calibrated torque wrench using a six-sided (hex) deep wall socket.

## TORQUE SPECIFICATIONS

Lug Nut/Bolt Torque	**Lug Nut/Bolt Size	Lug Nut/Bolt Socket Size
100 ft-lb (135 N·m)	M12 x 1.5	19 mm

\*\*Use only authorized dealer recommended lug nuts/bolts and clean or remove any dirt or oil before tightening.

Inspect the wheel mounting surface prior to mounting the tire and remove any corrosion or loose particles.

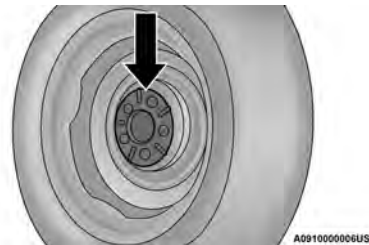

A091000006US

Wheel Mounting Surface

Tighten the lug nuts/bolts in a star pattern until each nut/bolt has been tightened twice. Ensure that the socket is fully engaged on the lug nut/bolt (do not insert it halfway).

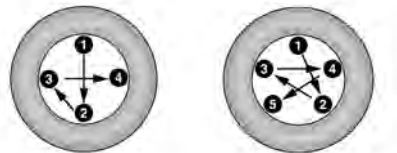

A091000006US

Torque Patterns

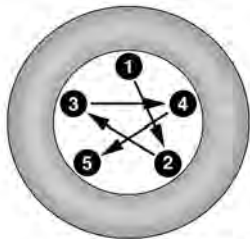

A091000004US

### Torque Pattern

After 25 miles (40 km) check the lug nut/bolt torque to be sure that all the lug nuts/bolts are properly tightened.

#### WARNING!

To avoid the risk of forcing the vehicle off the jack, do not tighten the lug nuts/bolts fully until the vehicle has been lowered. Failure to follow this warning may result in personal injury.

## FUEL REQUIREMENTS

While operating on gasoline with the required octane number, hearing a light knocking sound from the engine is not a cause for concern. However, if the engine is heard making a heavy knocking sound, see a dealer immediately. Use of gasoline with a lower than recommended octane number can cause engine failure and may void or not be covered by the New Vehicle Limited Warranty.

Poor quality gasoline can cause problems such as hard starting, stalling, and hesitations. If you experience these symptoms, try another brand of gasoline before considering service for the vehicle.

### 3.6L ENGINE

Do not use E-85 flex fuel or ethanol blends greater than 15% in this engine.



This engine is designed to meet all emissions regulations and provide optimum fuel economy and performance when using high quality unleaded regular gasoline having a posted octane number of 87 as specified by the (R+M)/2 method. The use of higher octane premium gasoline is not required, as it will not provide any benefit over regular gasoline in these engines.

## REFORMULATED GASOLINE

Many areas of the country require the use of cleaner burning gasoline referred to as "reformulated gasoline". Reformulated gasoline contains oxygenates and are specifically blended to reduce vehicle emissions and improve air quality.

The use of reformulated gasoline is recommended. Properly blended reformulated gasoline will provide improved performance and durability of engine and fuel system components.

## GASOLINE/OXYGENATE BLENDS

Some fuel suppliers blend unleaded gasoline with oxygenates such as ethanol.

#### CAUTION!

DO NOT use E-85, gasoline containing methanol, or gasoline containing more than 15% ethanol (E-15). Use of these blends may result in starting and drivability problems, damage critical fuel system components, cause emissions to exceed the applicable standard, and/or cause the Malfunction Indicator Light to illuminate. Please observe pump labels as they should clearly communicate if a fuel contains greater than 15% ethanol (E-15).

Problems that result from using gasoline containing more than 15% ethanol (E-15) or gasoline containing methanol are not the responsibility of the manufacturer and may void or not be covered under New Vehicle Limited Warranty.



## DO NOT USE E-85 IN NON-FLEX FUEL VEHICLES

Non-Flex Fuel Vehicles (FFV) are compatible with gasoline containing up to 15% ethanol (E-15). Use of gasoline with higher ethanol content may void the New Vehicle Limited Warranty.

If a Non-FFV vehicle is inadvertently fueled with E-85 fuel, the engine will have some or all of these symptoms:

- Undesirable lean conditions
- OBD II Malfunction Indicator Light on
- Poor engine performance
- Poor cold start and cold drivability
- Increased risk for fuel system component corrosion

## CNG AND LP FUEL SYSTEM MODIFICATIONS

Modifications that allow the engine to run on Compressed Natural Gas (CNG) or Liquid Propane (LP) may result in damage to the engine, emissions, and fuel system components. Problems that result from running CNG or LP are not the responsibility of the manufacturer and may void or not be covered under the New Vehicle Limited Warranty.

## METHYLCYCLOPENTADIENYL MANGANESE TRICARBONYL (MMT) IN GASOLINE

MMT is a manganese-containing metallic additive that is blended into some gasolines to increase octane. Gasoline blended with MMT provides no performance advantage beyond gasoline of the same octane number

without MMT. Gasoline blended with MMT reduces spark plug life and reduces emissions system performance in some vehicles. The manufacturer recommends that gasoline without MMT be used in your vehicle. The MMT content of gasoline may not be indicated on the gasoline pump; therefore, you should ask your gasoline retailer whether the gasoline contains MMT. MMT is prohibited in Federal and California reformulated gasoline.

## MATERIALS ADDED TO FUEL

Besides using unleaded gasoline with the proper octane rating, gasolines that contain detergents, corrosion and stability additives are recommended. Using gasolines that have these additives will help improve fuel economy, reduce emissions, and maintain vehicle performance.



Designated TOP TIER Detergent Gasoline contains a higher level of detergents to further aid in minimizing engine and fuel system deposits. When available, the usage of

TOP TIER Detergent gasoline is recommended. Visit [www.toptiergas.com](http://www.toptiergas.com) for a list of TOP TIER Detergent Gasoline retailers.

Indiscriminate use of fuel system cleaning agents should be avoided. Many of these materials intended for gum and varnish removal may contain active solvents or similar ingredients. These can harm fuel system gasket and diaphragm materials.

## FUEL SYSTEM CAUTIONS

### CAUTION!

Follow these guidelines to maintain your vehicle's performance:

- The use of leaded gasoline is prohibited by Federal law. Using leaded gasoline can impair engine performance and damage the emissions control system.
- An out-of-tune engine or certain fuel or ignition malfunctions can cause the catalytic converter to overheat. If you notice a pungent burning odor or some light smoke, your engine may be out of tune or malfunctioning and may require immediate service. Contact an authorized dealer for service assistance.
- The use of fuel additives, which are now being sold as octane enhancers, is not recommended. Most of these products contain high concentrations of methanol. Fuel system damage or vehicle performance problems resulting from the use of such fuels or additives is not the responsibility of the manufacturer and may void or not be covered under the New Vehicle Limited Warranty.

### NOTE:

Intentional tampering with the emissions control system can result in civil penalties being assessed against you.

## FLUID CAPACITIES

	US	Metric
<b>Fuel (Approximate)</b>		
3.6L Engine	19 gal	71 L
<b>Engine Oil With Filter</b>		
3.6L Engine	5 qt	4.7 L
<b>Cooling System*</b>		
3.6L Engine	15 qt	14.2 L
* Includes heater and coolant reservoir filled to MAX level.		

## FLUID CAPACITIES — HYBRID

	US	Metric
<b>Fuel (Approximate)</b>		
3.6L Engine	17 gal	64 L
<b>Engine Oil With Filter</b>		
3.6L Engine	5 qt	4.7 L
<b>Cooling System*</b>		
3.6L Engine	17.3 qt	16.4 L
Battery Coolant	4.5 qt	4.3 L
Power Electronics Coolant	3.6 qt	3.4 L
* Includes heater and coolant reservoir filled to MAX level.		

### NOTE:

Battery Coolant and Power Electronics Coolant reservoir require a special tool to service the coolant system. Contact an authorized dealer for service.

## ENGINE FLUIDS AND LUBRICANTS

Component	Fluid, Lubricant, or Genuine Part
Engine Coolant	We recommend using Mopar® Antifreeze/Coolant 10 Year/150,000 Mile (240,000 km) Formula OAT (Organic Additive Technology) or equivalent meeting the requirements of the manufacturer Material Standard MS.90032.
Engine Oil – 3.6L Engine	We recommend using Mopar® SAE 0W-20 Full Synthetic Engine Oil which meets the requirements of the manufacturer Material Standard MS-6395. Equivalent full synthetic SAE 0W-20 engine oil can be used but must have the API Starburst trademark ↩ page 269.
Fuel Selection – 3.6L Engine	87 Octane (R+M)/2 Method, 0-15% ethanol (Do not use E-85).

### CAUTION!

- Mixing of engine coolant (antifreeze) other than specified Organic Additive Technology (OAT) engine coolant (antifreeze), may result in engine damage and may decrease corrosion protection. Organic Additive Technology (OAT) engine coolant is different and should not be mixed with Hybrid Organic Additive Technology (HOAT) engine coolant (antifreeze) or any “globally compatible” coolant (antifreeze). If a non-OAT engine coolant (antifreeze) is introduced into the cooling system in an emergency, the cooling system will need to be drained, flushed, and refilled with fresh OAT coolant (conforming to MS.90032), by an authorized dealer as soon as possible.
- Do not use water alone or alcohol-based engine coolant (antifreeze) products. Do not use additional rust inhibitors or antirust products, as they may not be compatible with the radiator engine coolant and may plug the radiator.
- This vehicle has not been designed for use with propylene glycol-based engine coolant (antifreeze). Use of propylene glycol-based engine coolant (antifreeze) is not recommended.

## ENGINE FLUIDS AND LUBRICANTS — HYBRID

Component	Fluid, Lubricant, or Genuine Part
Engine Coolant, Battery Coolant, Power Electric Coolant	We recommend using Mopar® Antifreeze/Coolant 10 Year/150,000 Mile (240,000 km) Formula OAT (Organic Additive Technology) with deionized, or distilled water for proper corrosion protection or equivalent meeting the requirements of the manufacturer Material Standard MS.90032.
Engine Oil – 3.6L Engine	We recommend using Mopar® SAE 0W-20 Full Synthetic Engine Oil which meets the requirements of the manufacturer Material Standard MS-6395. Equivalent full synthetic SAE 0W-20 engine oil can be used but must have the API Starburst trademark.
Fuel Selection	87 Octane (R+M)/2 Method, 0-15% Ethanol (Do not use E-85).

**CAUTION!**

- Mixing of engine coolant (antifreeze) other than specified Organic Additive Technology (OAT) engine coolant (antifreeze), may result in engine damage and may decrease corrosion protection. Organic Additive Technology (OAT) engine coolant is different and should not be mixed with Hybrid Organic Additive Technology (HOAT) engine coolant (antifreeze) or any “globally compatible” coolant (antifreeze). If a non-OAT engine coolant (antifreeze) is introduced into the cooling system in an emergency, the cooling system will need to be drained, flushed, and refilled with fresh OAT coolant (conforming to MS.90032), by an authorized dealer as soon as possible.
- Do not use water alone or alcohol-based engine coolant (antifreeze) products. Do not use additional rust inhibitors or antirust products, as they may not be compatible with the radiator engine coolant and may plug the radiator.
- This vehicle has not been designed for use with propylene glycol-based engine coolant (antifreeze). Use of propylene glycol-based engine coolant (antifreeze) is not recommended.

**CHASSIS FLUIDS AND LUBRICANTS**

Component	Fluid, Lubricant, or Genuine Part
Automatic Transmission	Use only Mopar® ZF 8 & 9 Speed ATF Automatic Transmission Fluid, or equivalent. Failure to use the correct fluid may affect the function or performance of your transmission.
Brake Master Cylinder	We recommend using Mopar® DOT 3 Brake Fluid, SAE J1703 should be used.

**CHASSIS FLUIDS AND LUBRICANTS — HYBRID**

Component	Fluid, Lubricant, or Genuine Part
Automatic Transmission	Use only Mopar® ZF 8 & 9 Speed ATF Automatic Transmission Fluid, or equivalent. Failure to use the correct fluid may affect the function or performance of your transmission.
Brake Master Cylinder	We recommend using Mopar® DOT 3 Brake Fluid, SAE J1703 should be used. Use only recommended brake fluids.

# CUSTOMER ASSISTANCE

## SUGGESTIONS FOR OBTAINING SERVICE FOR YOUR VEHICLE

### PREPARE FOR THE APPOINTMENT

All work to be performed may not be covered by the warranty. Discuss additional charges with the service manager. Keep a maintenance log of your vehicle's service history. This can often provide a clue to the current problem.

### PREPARE A LIST

Make a written list of your vehicle's problems or the specific work you want done. If you've had an accident or work done that is not on your maintenance log, let the service advisor know.

### BE REASONABLE WITH REQUESTS

If you list a number of items and you must have your vehicle by the end of the day, discuss the situation with the service advisor and list the items in order of priority. At many authorized dealers, you may obtain a rental vehicle (additional charges may apply). If you need a rental, it is advisable to make these arrangements when you call for an appointment.

## IF YOU NEED ASSISTANCE

FCA US LLC and its authorized dealers are vitally interested in your satisfaction. We want you to be happy with our products and services.

Warranty service must be done by an authorized dealer. We strongly recommend that you take the vehicle to an authorized dealer. They know your vehicle the best, and are most concerned that you get prompt and high quality service. FCA US LLC's authorized dealers have the facilities, factory-trained technicians, special tools, and the latest information to ensure the vehicle is fixed correctly and in a timely manner.

This is why you should always talk to an authorized dealer's service manager first. If for some reason you are still not satisfied, talk to the general manager or owner of the authorized dealer. They want to know if you need assistance. If an authorized dealer is unable to resolve the concern, you may contact FCA US LLC's Customer Assistance center.

Any communication to FCA US LLC's customer center should include the following information:

- Owner's name and address
- Owner's telephone number (home, mobile, and office)
- Authorized dealer name
- Vehicle Identification Number (VIN)
- Vehicle delivery date and mileage

## ROADSIDE ASSISTANCE

Available 24 hours, 7 days a week.

Call 1-800-521-2779 or visit [chrysler.rsahelp.com\(USA\)](http://chrysler.rsahelp.com(USA))

Call 1-800-363-4869 or visit [fca.roadsideaid.com](http://fca.roadsideaid.com) (Canada)

### Who is Covered

You are covered by Roadside Assistance services if you are a purchaser for use of the vehicle. Roadside Assistance services last for five years or 60,000 miles on the odometer, whichever occurs first, calculated from the start date of the Basic Limited Warranty, as set forth in your Warranty Information book.<sup>1</sup>

1. Towing services provided through Cross Country Motor Club, Inc., 400 River's Edge Drive, Medford, MA 02155, except in AK, CA, HI, OR, WI, and WY, where services are provided by Cross Country Motor Club of California, Inc., 275 East Hillcrest Drive, Suite 165, Thousand Oaks, CA 91360.

### What to Do

If your vehicle requires jump start assistance, out of gas/fuel delivery, tire service, lockout service or towing as a result of a mechanical breakdown, dial toll-free: USA: 1-800-521-2779/Canada: 1-800-363-4869. Provide your name, Vehicle Identification Number (VIN) required for covered services, license plate number, and your location, including the telephone number from which you are calling. Briefly describe the nature of the problem and answer a few simple questions. You will be given the name of the service provider and an estimated time of arrival. If you feel you are in an unsafe situation, please let us know. With your consent, we will contact local police or safety authorities.

**If Unable to Contact Roadside Assistance**

If you are unable to contact Roadside Assistance or unable to provide a valid Vehicle Identification Number (VIN), and you obtain towing services on your own, you may submit your original receipts from the licensed towing or service facility, for services rendered within 30 days of the occurrence. Be sure to include your VIN, odometer mileage at the time of service, and current mailing address. We will process the claim based on vehicle and service eligibility. If eligible, we will reimburse you for the reasonable amount actually paid, based on the usual and customary charges for that service in the area where they were provided. FCA US LLC's determination relating to reimbursement is final. Correspondence should be mailed to:

FCA US LLC Customer Assistance

P.O. Box 9145

Medford, MA 02155

Attention Claims Department

FCA US LLC reserves the right to modify the terms or discontinue the Roadside Assistance Program at any time. The Roadside Assistance program is subject to restrictions and conditions of use, which are determined solely by FCA US LLC.

**Flat Tire Service**

If you are inconvenienced by a flat tire, we will dispatch a service provider to use your vehicle's temporary spare tire (if equipped) as recommended in your Owner's Manual. This is not a permanent flat tire repair.

**Out of Gas/Fuel Delivery**

Drivers cannot always count on a gas station being nearby, especially when traveling away from home. We will dispatch a service provider to deliver a small

amount of fuel (maximum two gallons) to get you to a nearby station. This service is limited to two occurrences in a 12-month period.

**Battery Jump Assistance**

No time is a good time for a depleted battery. With Roadside Assistance, you do not have to worry about being stranded. We will dispatch a service provider to provide you with a battery jump anytime, day or night.

**Lockout Service**

Whether the keys are locked in your vehicle or frozen locks are keeping you from getting on your way, help is just a phone call away. This service is limited to providing access to the vehicle's seating area. It does not cover the cost of replacement keys.

**Towing Service**

Our towing service gives you peace of mind and confidence. If your vehicle becomes disabled as a result of a mechanical breakdown, Roadside Assistance will dispatch a towing service to transport your vehicle to the closest authorized Chrysler, Dodge, Jeep®, or Ram dealer. If you choose to go to another dealer, you will be responsible for the cost of the extra distance.

**FCA US LLC CUSTOMER CENTER**

P.O. Box 21-8004

Auburn Hills, MI 48321-8004

Phone: (800) 247-9753

**FCA CANADA CUSTOMER CARE**

P.O. Box 1621

Windsor, Ontario N9A 4H6

Phone: (800) 465-2001 English / (800) 387-9983 French

**MEXICO****Customer Relations Office**

Av. Prolongacion Paseo de la Reforma, 1240

Sante Fe C.P. 05109

Mexico, CDMX

In Mexico City: 800-505-1300

Outside Mexico City: +(52)55 50817568

**PUERTO RICO AND US VIRGIN ISLANDS****FCA Caribbean LLC Customer Service**

P.O. Box 191857

San Juan 00919-1857

Phone: (800) 247-9753

**CUSTOMER ASSISTANCE FOR THE HEARING OR SPEECH IMPAIRED (TDD/TTY)**

To assist customers who have hearing difficulties, FCA US LLC has installed special TDD (Telecommunication Devices for the Deaf) equipment at its customer center. Any hearing or speech impaired customer, who has access to a TDD or a conventional teletypewriter (TTY) in the United States, can communicate with FCA US LLC by dialing 1-800-380-2479.

Canadian residents with hearing difficulties that require assistance can use the special needs relay service offered by Bell Canada. For TTY teletypewriter users, dial 711 and for Voice callers, dial 1-800-855-0511 to connect with a Bell Relay Service operator.

## SERVICE CONTRACT

You may have purchased a service contract for a vehicle to help protect you from the high cost of unexpected repairs after FCA US LLC's New Vehicle Limited Warranty expires. The Mopar® Vehicle Protection plans are the ONLY vehicle extended protection plans authorized, endorsed and backed by FCA US LLC to provide additional protection beyond your vehicle's warranty. If you purchased a Mopar® Vehicle Protection Plan, you will receive Plan Provisions and an Owner Identification Card in the mail within three weeks of the vehicle delivery date. If you have any questions about the service contract, call FCA US LLC's Service Contract National Customer Hotline at 1-800-521-9922.

For Canadian residents, you may have purchased additional coverage with an extended service contract. FCA Canada Inc. stands fully behind its service contracts. Be sure that the one you buy is a genuine Canada Inc. service contract. We are not responsible for other companies' contracts. If you purchased a contract other than a genuine FCA Canada Inc. service contract and you have a problem, you will have to contact the administrator of that contract for resolution. If you have any questions about the service contract, call the FCA's Service Contract National Customer Hotline at (800) 465-2001 English / (800) 387-9983 French).

FCA US LLC is not responsible for any service contract you may have purchased from another manufacturer. If you require service after the FCA US LLC New Vehicle Limited Warranty expires, please refer to the contract documents, and contact the person listed in those documents.

We appreciate that you have made a major investment when you purchased the vehicle. An authorized dealer has also made a major investment in facilities, tools, and training to assure that you are absolutely delighted with the ownership experience.

## WARRANTY INFORMATION

See the Warranty Information for the terms and provisions of FCA US LLC warranties applicable to this vehicle and market. Refer to [www.mopar.com/om](http://www.mopar.com/om) for further information.

In Canada:

See the Warranty Information for the terms and provisions of FCA Canada Inc. warranties applicable to this vehicle and market. Refer to [owners.mopar.ca/en/](http://owners.mopar.ca/en/) for further information.

For French, refer to [owners.mopar.ca/fr/](http://owners.mopar.ca/fr/) for further information.

Use this QR code to access your digital experience.



## MOPAR® PARTS

Mopar® original equipment parts & accessories and factory filled fluids are available from an authorized dealer. They are recommended for your vehicle to keep it operating at its best and maintain its original condition.

## REPORTING SAFETY DEFECTS

IN THE 50 UNITED STATES AND WASHINGTON, D.C.

If you believe that your vehicle has a defect that could cause a crash or cause injury or death, you should immediately inform the National Highway Traffic Safety Administration (NHTSA) in addition to notifying FCA US LLC.

If NHTSA receives similar complaints, it may open an investigation, and if it finds that a safety defect exists in a group of vehicles, it may order a recall and remedy campaign. However, NHTSA cannot become involved in individual problems between you, an authorized dealer or FCA US LLC.

To contact NHTSA, you may call the Vehicle Safety Hotline toll free at 1-888-327-4236 (TTY: 1-800-424-9153); or go to <http://www.safercar.gov>; or write to: Administrator, NHTSA, 1200 New Jersey Avenue, SE., West Building, Washington, D.C. 20590. You can also obtain other information about motor vehicle safety from <http://www.safercar.gov>.

## IN CANADA

If you believe that your vehicle has a safety defect, you should contact the Customer Service Department immediately. Canadian customers who wish to report a safety defect to the Canadian government should contact Transport Canada, Motor Vehicle Defect Investigations and Recalls at 1-800-333-0510 or go to [www.apps.tc.gc.ca/Saf-Sec-Sur/7/PCDB-BDPP](http://www.apps.tc.gc.ca/Saf-Sec-Sur/7/PCDB-BDPP).

## PUBLICATION ORDER FORMS

To order the following manuals, you may use either the website or the phone numbers listed below.

### Service Manuals

These comprehensive Service Manuals provide a complete working knowledge of the vehicle, system, and/or components and is written in straightforward language with illustrations, diagrams, and charts.

### Diagnostic Procedure Manuals

Diagnostic Procedure Manuals are filled with diagrams, charts and detailed illustrations. These manuals make it easy to find and fix problems on computer-controlled vehicle systems and features. They show exactly how to find and correct problems, using step-by-step troubleshooting and drivability procedures, proven diagnostic tests and a complete list of all tools and equipment.

To order a digital copy of your Service or Diagnostic Procedure manuals, visit:

[www.techauthority.com](http://www.techauthority.com) (US and Canada).

### Owner's Manuals

These Owner's Manuals have been prepared with the assistance of service and engineering specialists to acquaint you with specific FCA vehicles.

To access your Owner's Information online, visit [www.mopar.com/om](http://www.mopar.com/om) (US) or [www.owners.mopar.ca/en/](http://www.owners.mopar.ca/en/) (Canada).

Or visit:

[www.techauthority.com](http://www.techauthority.com) to order physical copies of Owner's Manuals (US).

Owner's Manuals, Radio Manuals and Warranty Information Books can be ordered through Archway at:

- 1-800-387-1143 (Canada)

## Change Of Ownership Or Address

\*If you have purchased this vehicle used or have changed your address, please provide the following information and mail to:

### FCA US LLC

P.O. Box 21-8008

Auburn Hills, MI 48321-8004

Make sure to include the following:

- Date of Sale (mm/dd/yy)
- Vehicle Identification Number (17 Character ID located on top left of the instrument panel)
- Exact Odometer Reading
- First and Last Name
- Phone Number
- Street Address, City, State and Zip Code
- Email Address

\*Applies to US residents only.

## GENERAL INFORMATION

The following regulatory statement applies to all Radio Frequency (RF) devices equipped in this vehicle:

This device complies with Part 15 of the FCC Rules and with Innovation, Science and Economic Development Canada license-exempt RSS standard(s). Operation is subject to the following two conditions:

1. This device may not cause harmful interference, and
2. This device must accept any interference received, including interference that may cause undesired operation.



Le présent appareil est conforme aux CNR d'Innovation, Science and Economic Development applicables aux appareils radio exempts de licence. L'exploitation est autorisée aux deux conditions suivantes:

1. l'appareil ne doit pas produire de brouillage, et
2. l'utilisateur de l'appareil doit accepter tout brouillage radioélectrique subi, même si le brouillage est susceptible d'en compromettre le fonctionnement.

La operación de este equipo está sujeta a las siguientes dos condiciones:

1. es posible que este equipo o dispositivo no cause interferencia perjudicial y
2. este equipo o dispositivo debe aceptar cualquier interferencia, incluyendo la que pueda causar su operación no deseada.

**NOTE:**

Changes or modifications not expressly approved by the party responsible for compliance could void the user's authority to operate the equipment.

# INDEX

## A

About Your Brakes . . . . .	309
Adaptive Cruise Control (ACC) (Cruise Control) .	136, 138
Adding Engine Coolant (Antifreeze) . . . . .	277
Additives, Fuel. . . . .	311
Adjust	
Down . . . . .	49
Forward . . . . .	49
Rearward . . . . .	49
Up . . . . .	49
Air Bag . . . . .	217
Air Bag Operation . . . . .	218
Air Bag Warning Light . . . . .	216, 218
Driver Knee Air Bag . . . . .	221
Enhanced Accident Response . . . . .	224, 263
Event Data Recorder (EDR) . . . . .	263
Front Air Bag . . . . .	218
If Deployment Occurs . . . . .	223
Knee Impact Bolsters . . . . .	221
Maintaining Your Air Bag System . . . . .	224
Maintenance . . . . .	224
Redundant Air Bag Warning Light . . . . .	216
Side Air Bags . . . . .	221
Transporting Pets . . . . .	238
Air Bag Light . . . . .	111, 216, 238
Air Cleaner, Engine (Engine Air Cleaner Filter) . .	270
Air Conditioner Maintenance . . . . .	271
Air Conditioner Refrigerant . . . . .	271
Air Conditioner System . . . . .	271
Air Conditioning Filter . . . . .	77, 271
Air Conditioning, Operating Tips . . . . .	76
Air Filter. . . . .	270

Air Pressure	
Tires . . . . .	297
Alarm	
Arm The System . . . . .	30
Disarm The System . . . . .	30
Security Alarm . . . . .	113
All Wheel Drive	
Towing . . . . .	263
All Wheel Drive (AWD) . . . . .	134
Alterations/Modifications	
Vehicle . . . . .	8
Amazon FireTV . . . . .	185, 189
Amazon FireTV Built-In. . . . .	185
Antifreeze (Engine Coolant) . . . . .	276, 279, 312
Disposal . . . . .	277, 280
Anti-Lock Brake System (ABS) . . . . .	194
Anti-Lock Warning Light . . . . .	113
Assist, Hill Start . . . . .	197
Audio Jack . . . . .	80
Audio Systems (Radio). . . . .	169
Automatic Dimming Mirror . . . . .	56
Automatic Headlights . . . . .	64
Automatic Temperature Control (ATC) . . . . .	76
Automatic Transaxle . . . . .	128
Automatic Transmission . . . . .	129
Adding Fluid . . . . .	282, 314
Fluid And Filter Change . . . . .	282
Fluid Change . . . . .	282
Fluid Level Check . . . . .	281, 282
Fluid Type . . . . .	282, 314
Special Additives . . . . .	281
AutoPark. . . . .	119, 123
Auto Up Power Windows . . . . .	85

AUX Cord . . . . .	80
Auxiliary Electrical Outlet (Power Outlet) . . . .	81
AWD	
Towing . . . . .	263
Axle Lubrication . . . . .	314

## B

Back Up Camera . . . . .	154
Battery . . . . .	13, 111, 268
Charging . . . . .	15
Charging System Light . . . . .	111
Jump Starting . . . . .	254, 256
Keyless Key Fob Replacement . . . . .	21
Battery Saver Feature. . . . .	65
Belts, Seat . . . . .	238
Blind Spot Monitoring . . . . .	199
Body Mechanism Lubrication . . . . .	272
B-Pillar Location. . . . .	294
Brake Assist System. . . . .	195
Brake Control System, Electronic. . . . .	195
Brake Fluid . . . . .	314
Brake System . . . . .	281, 309
Anti-Lock (ABS) . . . . .	309
Fluid Check . . . . .	281, 314
Master Cylinder . . . . .	281
Parking . . . . .	126
Warning Light . . . . .	111
Brake/Transmission Interlock . . . . .	129
Brightness, Interior Lights . . . . .	65
Bulb Replacement . . . . .	289, 290
Bulbs, Light. . . . .	239, 289, 290

**C**

Camera . . . . .	.154
Camera, Rear . . . . .	.154, 155
Capacities, Fluid . . . . .	.312
Caps, Filler	
Fuel . . . . .	.157, 158
Oil (Engine) . . . . .	.266
Radiator (Coolant Pressure) . . . . .	.277, 280
Carbon Monoxide Warning . . . . .	.240
Cargo	
Vehicle Loading . . . . .	.91
Cargo Compartment	
Luggage Carrier . . . . .	.95
Cargo Load Floor . . . . .	.91
Car Washes . . . . .	.306
Cellular Phone . . . . .	.193
Certification Label . . . . .	.160
Chains, Tire . . . . .	.302
Change Oil Indicator . . . . .	.105
Changing A Flat Tire . . . . .	.244
Charging . . . . .	.15
Chart, Tire Sizing . . . . .	.292
Check Engine Light (Malfunction Indicator Light) . . . . .	.118
Checking Your Vehicle For Safety . . . . .	.238
Checks, Safety . . . . .	.238
Child Restraint . . . . .	.225
Child Restraints	
Booster Seats . . . . .	.227
Center Seat LATCH . . . . .	.232
Child Seat Installation . . . . .	.233, 235
How To Stow An unused ALR Seat Belt . . . . .	.233
Infant And Child Restraints . . . . .	.226
Lower Anchors And Tethers For Children . . . . .	.228
Older Children And Child Restraints . . . . .	.227
Seating Positions . . . . .	.228
Using The Top Tether Anchorage . . . . .	.236

Clean Air Gasoline . . . . .	.310
Cleaning	
Wheels . . . . .	.301
Climate Control . . . . .	.67
Automatic . . . . .	.67
Manual . . . . .	.72
Rear . . . . .	.71, 75
Cold Weather Operation . . . . .	.122
Compact Spare Tire . . . . .	.300
Contract, Service . . . . .	.317
Cooling Pressure Cap (Radiator Cap) . . . . .	.277, 280
Cooling System . . . . .	.276, 278
Adding Coolant (Antifreeze) . . . . .	.277
Coolant Level . . . . .	.277, 280
Cooling Capacity . . . . .	.312
Disposal Of Used Coolant . . . . .	.277, 280
Drain, Flush, And Refill . . . . .	.276, 279
Inspection . . . . .	.276, 277, 278, 280
Points To Remember . . . . .	.277
Pressure Cap . . . . .	.277, 280
Radiator Cap . . . . .	.277, 280
Selection Of Coolant (Antifreeze) . . . . .	.276, 279, 312, 313
Corrosion Protection . . . . .	.306
Cruise Control . . . . .	.136
Cruise Control (Speed Control) . . . . .	.138
Cruise Light . . . . .	.116, 117
Customer Assistance . . . . .	.315
Cybersecurity . . . . .	.169

**D**

Daytime Running Lights . . . . .	.62
Dealer Service . . . . .	.269
Defroster, Windshield . . . . .	.239
Delay (Intermittent) Wipers . . . . .	.66
Diagnostic System, Onboard . . . . .	.117

Dimmer Switch	
Headlight . . . . .	.62
Dipsticks	
Oil (Engine) . . . . .	.268
Disable Vehicle Towing . . . . .	.261
Disposal	
Antifreeze (Engine Coolant) . . . . .	.277, 280
Door Ajar . . . . .	.111, 112
Door Ajar Light . . . . .	.111, 112
Driver's Seat Back Tilt . . . . .	.38
Driving	
Through Flowing, Rising, Or Shallow Standing Water . . . . .	.168
<b>E</b>	
Electric Brake Control System . . . . .	.195
Anti-Lock Brake System . . . . .	.194
Traction Control System . . . . .	.199
Electric Parking Brake . . . . .	.126
Electronic Stability Control (ESC) . . . . .	.196
Electronic Throttle Control Warning Light . . . . .	.112
Emergency Braking . . . . .	.204
Emergency, In Case Of	
Hazard Warning Flasher . . . . .	.241
Jacking . . . . .	.244, 245
Jump Starting . . . . .	.254, 256
Overheating . . . . .	.259
Towing . . . . .	.261
Emission Control System Maintenance . . . . .	.118
Engine . . . . .	.266
Air Cleaner . . . . .	.270
Block Heater . . . . .	.125
Break-In Recommendations . . . . .	.126
Checking Oil Level . . . . .	.268
Compartment . . . . .	.266
Compartment Identification . . . . .	.266

Coolant (Antifreeze) . . . . .	.313
Cooling . . . . .	.276, 278
Exhaust Gas Caution . . . . .	.240
Fails To Start . . . . .	.121
Flooded, Starting . . . . .	.121
Fuel Requirements . . . . .	.310
Oil . . . . .	.269, 312, 313
Oil Filler Cap . . . . .	.266
Oil Filter . . . . .	.270
Oil Selection . . . . .	.269, 312
Oil Synthetic . . . . .	.269
Overheating . . . . .	.259
Starting . . . . .	.119, 122
Engine Oil Life  . . . . .	.105
Enhanced Accident Response Feature . . . . .	.224, 263
Ethanol . . . . .	.310
Exhaust Gas Cautions . . . . .	.240
Exhaust System . . . . .	.240, 275
Exterior Lighting . . . . .	.62, 290
Exterior Lights . . . . .	.62, 239, 289, 290

**F**

FamCam System . . . . .	.157
Filters . . . . .	
Air Cleaner . . . . .	.270
Air Conditioning . . . . .	.77, 271
Engine Oil . . . . .	.270
Engine Oil Disposal . . . . .	.269
FireTV . . . . .	.189
Flashers . . . . .	
Hazard Warning . . . . .	.241
Turn Signals . . . . .	.62, 116, 239, 290
Flash-To-Pass . . . . .	.62, 63
Flat Tire Changing . . . . .	.244, 291, 300
Flat Tire Stowage . . . . .	.250, 291, 300

Flooded Engine Starting . . . . .	.121
Fluid, Brake . . . . .	.314
Fluid Capacities . . . . .	.312
Fluid Leaks . . . . .	.240
Fluid Level Checks . . . . .	
Brake . . . . .	.281
Engine Oil . . . . .	.268
Fog Lights . . . . .	.62, 64
Fold-Flat Seats . . . . .	.38
Fold In Floor (Stow 'n Go) Seating . . . . .	.45
Forward Collision Warning . . . . .	.202
Freeing A Stuck Vehicle . . . . .	.261
Front Position Light . . . . .	.290
Fuel . . . . .	.310
Additives . . . . .	.311
Clean Air . . . . .	.310
Ethanol . . . . .	.310
Filler Cap (Gas Cap) . . . . .	.157, 158
Gasoline . . . . .	.310
Materials Added . . . . .	.311
Methanol . . . . .	.310
Octane Rating . . . . .	.310, 313
Requirements . . . . .	.310
Specifications . . . . .	.313
Tank Capacity . . . . .	.312
Fuses . . . . .	.282

**G**

Garage Door Opener (HomeLink®) . . . . .	.59
Gas Cap (Fuel Filler Cap) . . . . .	.157, 158
Gasoline, Clean Air . . . . .	.310
Gasoline, (Fuel) . . . . .	.310
Gasoline, Reformulated . . . . .	.310
Gear Ranges . . . . .	.129
Glass Cleaning . . . . .	.308
Gross Axle Weight Rating . . . . .	.161

Gross Vehicle Weight Rating . . . . .	.161
GVWR . . . . .	.160

**H**

Hands-Free Sliding Door . . . . .	.35
Hazard . . . . .	
Driving Through Flowing, Rising, Or Shallow Standing Water . . . . .	.168
Hazard Warning Flashers . . . . .	.241
Headlights . . . . .	.62
Cleaning . . . . .	.306
High Beam/Low Beam Select Switch . . . . .	.62
Lights On Reminder . . . . .	.62, 64
Passing . . . . .	.62, 63
Switch . . . . .	.62
Time Delay . . . . .	.62
Washers . . . . .	.64
Head Restraints . . . . .	.53
Heated Mirrors . . . . .	.56, 58
Heated Seats . . . . .	.52
Heater, Engine Block . . . . .	.125
High Voltage Battery . . . . .	.13
Hill Start Assist . . . . .	.197
Hitches . . . . .	
Trailer Towing . . . . .	.162
HomeLink® (Garage Door Opener) . . . . .	.59
Hood Prop . . . . .	.87
Hood Release . . . . .	.87

**I**

Ignition . . . . .	.23
Keyless Ignition PHEV . . . . .	.24
Switch . . . . .	.23



Locks	
Automatic Door . . . . .	.30
Child Protection . . . . .	.30
Manual . . . . .	.30
Power Door . . . . .	.30
Low Tire Pressure System . . . . .	.205
Lubrication, Body . . . . .	.272
Luggage Carrier . . . . .	.95
Lug Nuts . . . . .	.309
<b>M</b>	
Maintenance . . . . .	.87
Maintenance Free Battery . . . . .	.268
Maintenance Schedule . . . . .	.264
Malfunction Indicator Light (Check Engine) . . . . .	.114, 118
Manual	
Park Release . . . . .	.260
Service . . . . .	.318
Map/Reading Lights . . . . .	.65
Marker Lights, Side . . . . .	.290
Media Hub . . . . .	.80
Memory Seat . . . . .	.37
Methanol . . . . .	.310
Mirrors . . . . .	.56
Automatic Dimming . . . . .	.56
Exterior Folding . . . . .	.58
Heated . . . . .	.56, 58
Memory . . . . .	.37
Outside . . . . .	.56, 57
Rearview . . . . .	.56, 241
Vanity . . . . .	.57
Modifications/Alterations	
Vehicle . . . . .	.8
Monitor, Tire Pressure System . . . . .	.205
Mopar Parts . . . . .	.317
MP3 Control . . . . .	.80
Multi-Function Control Lever . . . . .	.62
<b>N</b>	
New Vehicle Break-In Period . . . . .	.126
<b>O</b>	
Occupant Restraints . . . . .	.207
Octane Rating, Gasoline (Fuel) . . . . .	.310, 313
Oil Change Indicator . . . . .	.105
Reset . . . . .	.105
Oil, Engine . . . . .	.269, 313
Capacity . . . . .	.312
Checking . . . . .	.268
Dipstick . . . . .	.268
Disposal . . . . .	.269
Filter . . . . .	.270
Filter Disposal . . . . .	.269
Identification Logo . . . . .	.269
Materials Added To . . . . .	.269
Pressure Warning Light . . . . .	.112
Recommendation . . . . .	.269, 312
Synthetic . . . . .	.269
Viscosity . . . . .	.312
Oil Filter, Change . . . . .	.270
Oil Filter, Selection . . . . .	.270
Oil Pressure Light . . . . .	.112
Onboard Diagnostic System . . . . .	.117
Operating Precautions . . . . .	.117
Operator Manual	
Owner's Manual . . . . .	.318
Outside Rearview Mirrors . . . . .	.56, 57
Overheating, Engine . . . . .	.259
<b>P</b>	
Paint Care . . . . .	.306
Parking Brake . . . . .	.126
ParkSense	
Front And Rear . . . . .	.145
ParkSense Active Park Assist . . . . .	.149
ParkSense System, Rear . . . . .	.145
Passive Entry . . . . .	.31
Pedestrian Warning System . . . . .	.195
Pets . . . . .	.238
Placard, Tire And Loading Information . . . . .	.294
Power	
Brakes . . . . .	.309
Inverter . . . . .	.83
Mirrors . . . . .	.57
Outlet (Auxiliary Electrical Outlet) . . . . .	.81
Seats . . . . .	.49, 50
Steering . . . . .	.134
Power Seats	
Down . . . . .	.49
Forward . . . . .	.49
Rearward . . . . .	.49
Up . . . . .	.49
Power Sliding Door	
On / Off Switch . . . . .	.34, 88
Pregnant Women And Seat Belts . . . . .	.213
Preparation For Jacking . . . . .	.244
Pretensioners	
Seat Belts . . . . .	.213
<b>Q</b>	
Quiet Vehicle Pedestrian Module (QVPM) . . . . .	.195

**R**

Radial Ply Tires . . . . .	.298
Radiator Cap (Coolant Pressure Cap) . . . . .	.277, 280
Radio Operation . . . . .	.193
Radio Remote Controls . . . . .	.185
Rear Air Conditioning . . . . .	.71, 75
Rear Camera . . . . .	.155
Rear Cross Path . . . . .	.201
Rear ParkSense System . . . . .	.145
Rear Seat Entertainment . . . . .	.185
Rear Seat Reminder . . . . .	.198
Rear View . . . . .	.56
Reclining Front Seats . . . . .	.39
Recreational Towing . . . . .	.167
Reformulated Gasoline . . . . .	.310
Refrigerant . . . . .	.271
Release, Hood . . . . .	.87
Reminder, Lights On . . . . .	.62
Reminder, Seat Belt . . . . .	.208
Remote Control	
Starting System . . . . .	.25, 27
Remote Keyless Entry	
Arm The Alarm . . . . .	.30
Disarm The Alarm . . . . .	.30
Programming Additional Key Fobs . . . . .	.22
Remote Sound System (Radio) Control . . . . .	.185
Remote Starting	
Exit Remote Start Mode . . . . .	.26, 28
Remote Starting System . . . . .	.25, 27
Replacement Bulbs . . . . .	.289
Replacement Tires . . . . .	.299
Reporting Safety Defects. . . . .	.317
Restraints, Child. . . . .	.225
Restraints, Head . . . . .	.53
Roof Luggage Rack . . . . .	.95
Rotation, Tires . . . . .	.304

**S**

Safety Checks Inside Vehicle. . . . .	.238
Safety Checks Outside Vehicle . . . . .	.239
Safety Defects, Reporting . . . . .	.317
Safety, Exhaust Gas . . . . .	.240
Safety Information, Tire . . . . .	.291
Safety Tips . . . . .	.238
Schedule, Maintenance . . . . .	.264
Screen Setup . . . . .	.108
Seat Belt Reminder . . . . .	.113
Seat Belts . . . . .	.208, 238
Adjustable Shoulder Belt . . . . .	.211
Adjustable Upper Shoulder Anchorage . . . . .	.211
Adjustable Upper Shoulder Belt Anchorage . . . . .	.211
Automatic Locking Retractor (ALR) . . . . .	.214
Child Restraints . . . . .	.225
Energy Management Feature . . . . .	.213
Extender . . . . .	.213
Front Seat . . . . .	.208, 209, 210
Inspection . . . . .	.238
Lap/Shoulder Belt Operation . . . . .	.210
Lap/Shoulder Belts . . . . .	.209
Lap/Shoulder Belt Untwisting . . . . .	.210
Operating Instructions . . . . .	.210
Pregnant Women . . . . .	.213
Pretensioners . . . . .	.213
Rear Seat . . . . .	.209
Reminder . . . . .	.208
Seat Belt Extender . . . . .	.213
Seat Belt Pretensioner . . . . .	.213
Untwisting Procedure . . . . .	.210
Seat Belts Maintenance . . . . .	.307
Seats. . . . .	.38, 49, 52
Adjustment . . . . .	.38, 39, 49
Heated . . . . .	.52
Memory . . . . .	.37
Power . . . . .	.49, 50

Rear Folding . . . . .	.38
Reclining . . . . .	.39
Seatback Release . . . . .	.38, 39
Stow 'n Go (Fold in Floor) . . . . .	.45
Tilting . . . . .	.38, 39
Security Alarm. . . . .	.113
Arm The System . . . . .	.30
Disarm The System . . . . .	.30
Selection Of Coolant (Antifreeze) . . . . .	.313
Sentry Key (Immobilizer) . . . . .	.22
Service Assistance . . . . .	.315
Service Contract. . . . .	.317
Service Manuals . . . . .	.318
Shifting	
Automatic Transmission . . . . .	.129
Shoulder Belts . . . . .	.209
Side View Mirror Adjustment . . . . .	.56
Signals, Turn . . . . .	.62, 116, 239, 290
SmartBeams . . . . .	.63
Snow Chains (Tire Chains) . . . . .	.302
Snow Tires . . . . .	.300
Spare Tire Changing. . . . .	.244
Spare Tires . . . . .	.244, 300, 301
Spare Tire Stowage . . . . .	.250
Specifications	
Oil . . . . .	.313
Speed Control	
Accel/Decel (ACC Only) . . . . .	.141
Cancel . . . . .	.138
Resume . . . . .	.138
Speed Control (Cruise Control) . . . . .	.138
Starting . . . . .	.25, 27, 119, 122
Button . . . . .	.23
Cold Weather . . . . .	.122
Engine Fails To Start . . . . .	.121
Remote . . . . .	.25, 27
Starting And Operating . . . . .	.119, 122
Starting Procedures . . . . .	.119, 122





**W**

Warning Lights	
Red . . . . .	.111
Yellow . . . . .	.113
Warning Lights And Messages . . . . .	.111
Warranty Information  . . . . .	.317
Washers, Windshield . . . . .	.268
Washing Vehicle. . . . .	.306
Water	
Driving Through . . . . .	.168
Wheel And Wheel Tire Care . . . . .	.301
Wheel And Wheel Tire Trim. . . . .	.301
Wind Buffeting . . . . .	.85
Window Fogging . . . . .	.76
Windows . . . . .	.84
Power . . . . .	.84
Windshield Defroster . . . . .	.239
Windshield Washers. . . . .	.66, 268
Fluid . . . . .	.268
Windshield Wiper Blades . . . . .	.273
Wipers Blade Replacement . . . . .	.273
Wipers, Intermittent. . . . .	.66
Wireless Charging Pad . . . . .	.83
Wrecker Towing . . . . .	.261

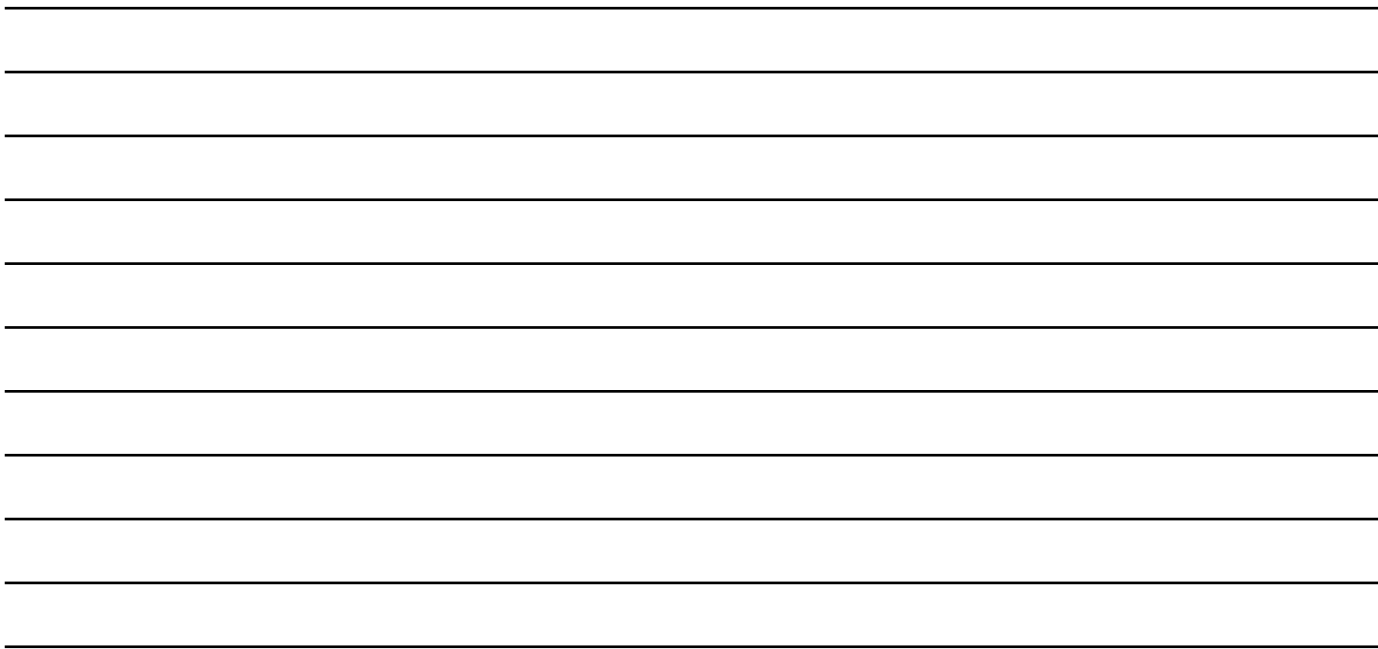



The driver's primary responsibility is the safe operation of the vehicle. Driving while distracted can result in loss of vehicle control, resulting in an accident and personal injury. FCA US LLC strongly recommends that the driver use extreme caution when using any device or feature that may take their attention off the road. Use of any electrical devices, such as cellular telephones, computers, portable radios, vehicle navigation or other devices by the driver while the vehicle is moving is dangerous and could lead to a serious accident. Texting while driving is also dangerous and should never be done while the vehicle is moving. If you find yourself unable to devote your full attention to vehicle operation, pull off the road to a safe location and stop your vehicle. Some states or provinces prohibit the use of cellular telephones or texting while driving. It is always the driver's responsibility to comply with all local laws.

This Owner's Manual has been prepared to help you get acquainted with your new Chrysler brand vehicle and to provide a convenient reference source for common questions.

Not all features shown in this manual may apply to your vehicle. For additional information, visit [mopar.com/om](http://mopar.com/om) (USA), [owners.mopar.ca](http://owners.mopar.ca) (Canada) or your local Chrysler dealer.

**U.S. Residents:** If you are the first registered retail owner of your vehicle, you may obtain a complimentary printed copy of the Warranty Booklet by calling **1-800-247-9753** or by contacting your dealer. Replacement kits can be purchased by visiting [www.techauthority.com](http://www.techauthority.com).

**Canadian Residents:** If you are the first registered retail owner of your vehicle, you may obtain a complimentary printed copy of the Warranty Booklet or purchase a replacement kit by calling **1-800-387-1143** or by contacting your dealer.

## DRIVING AND ALCOHOL

Drunk driving is one of the most frequent causes of accidents. Your driving ability can be seriously impaired with blood alcohol levels far below the legal minimum. If you are drinking, don't drive. Ride with a designated non-drinking driver, call a cab, a rideshare, a friend, or use public transportation.

## WARNING

Driving after drinking can lead to an accident. Your perceptions are less sharp, your reflexes are slower and your judgment is impaired when you have been drinking. Never drink and then drive.





Whether it's providing information about specific product features, taking a tour through your vehicle's heritage, knowing what steps to take following an accident or scheduling your next appointment, we know you'll find the app an important extension of your Chrysler brand vehicle. Simply download the app, select your make and model and enjoy the ride. To get this app, go directly to the App Store® or Google Play® Store and enter the search keyword "Chrysler" (U.S. residents only).

DOWNLOAD THE MOST UP-TO-DATE  
OWNER'S MANUAL, RADIO AND  
WARRANTY BOOKS

U.S.



[mopar.com/om](https://mopar.com/om)

CANADA



[owners.mopar.ca](https://owners.mopar.ca)